

# User's Guide

## Copyright

# Copyright

No part of this publication may be reproduced, stored in a retrieval system, or transmitted in any form or by any means, electronic, mechanical, photocopying, recording, or otherwise, without the prior written permission of Seiko Epson Corporation. No patent liability is assumed with respect to the use of the information contained herein. Neither is any liability assumed for damages resulting from the use of the information herein. The information contained herein is designed only for use with this Epson printer. Epson is not responsible for any use of this information as applied to other printers.

Neither Seiko Epson Corporation nor its affiliates shall be liable to the purchaser of this product or third parties for damages, losses, costs, or expenses incurred by the purchaser or third parties as a result of accident, misuse, or abuse of this product or unauthorized modifications, repairs, or alterations to this product, or (excluding the U.S.) failure to strictly comply with Seiko Epson Corporation's operating and maintenance instructions.

Seiko Epson Corporation and its affiliates shall not be liable for any damages or problems arising from the use of any options or any consumable products other than those designated as Original Epson Products or Epson Approved Products by Seiko Epson Corporation.

Seiko Epson Corporation shall not be held liable for any damage resulting from electromagnetic interference that occurs from the use of any interface cables other than those designated as Epson Approved Products by Seiko Epson Corporation.

© 2014 Seiko Epson Corporation. All rights reserved.

The contents of this manual and the specifications of this product are subject to change without notice.

# Trademarks

- ❑ EPSON® is a registered trademark, and EPSON EXCEED YOUR VISION or EXCEED YOUR VISION is a trademark of Seiko Epson Corporation.
- ❑ PRINT Image Matching™ and the PRINT Image Matching logo are trademarks of Seiko Epson Corporation. Copyright © 2001 Seiko Epson Corporation. All rights reserved.
- ❑ EPSON Scan software is based in part on the work of the Independent JPEG Group.
- ❑ libtiff

Copyright © 1988-1997 Sam Leffler

Copyright © 1991-1997 Silicon Graphics, Inc.

Permission to use, copy, modify, distribute, and sell this software and its documentation for any purpose is hereby granted without fee, provided that (i) the above copyright notices and this permission notice appear in all copies of the software and related documentation, and (ii) the names of Sam Leffler and Silicon Graphics may not be used in any advertising or publicity relating to the software without the specific, prior written permission of Sam Leffler and Silicon Graphics.

THE SOFTWARE IS PROVIDED "AS-IS" AND WITHOUT WARRANTY OF ANY KIND, EXPRESS, IMPLIED OR OTHERWISE, INCLUDING WITHOUT LIMITATION, ANY WARRANTY OF MERCHANTABILITY OR FITNESS FOR A PARTICULAR PURPOSE.

IN NO EVENT SHALL SAM LEFFLER OR SILICON GRAPHICS BE LIABLE FOR ANY SPECIAL, INCIDENTAL, INDIRECT OR CONSEQUENTIAL DAMAGES OF ANY KIND, OR ANY DAMAGES WHATSOEVER RESULTING FROM LOSS OF USE, DATA OR PROFITS, WHETHER OR NOT ADVISED OF THE POSSIBILITY OF DAMAGE, AND ON ANY THEORY OF LIABILITY, ARISING OUT OF OR IN CONNECTION WITH THE USE OR PERFORMANCE OF THIS SOFTWARE.

- ❑ SDXC Logo is a trademark of SD-3C, LLC.



- ❑ PictBridge is a trademark.



- ❑ Microsoft®, Windows®, and Windows Vista® are registered trademarks of Microsoft Corporation.
- ❑ Apple, Macintosh, Mac OS, OS X, Bonjour, Safari, iPad, iPhone, iPod touch, and iTunes are trademarks of Apple Inc., registered in the U.S. and other countries. AirPrint and the AirPrint logo are trademarks of Apple Inc.
- ❑ Google Cloud Print™, Chrome™, Chrome OS™, and Android™ are trademarks of Google Inc.
- ❑ Adobe, Adobe Reader, Acrobat, and Photoshop are trademarks of Adobe systems Incorporated, which may be registered in certain jurisdictions.
- ❑ ABBYY® and ABBYY FineReader® names and logos are registered trademarks of ABBYY Software House.
- ❑ Intel® is a registered trademark of Intel Corporation.

## Trademarks

- ❑ General Notice: Other product names used herein are for identification purposes only and may be trademarks of their respective owners. Epson disclaims any and all rights in those marks.

## Contents

### Copyright

### Trademarks

### About This Manual

|   |   |
|---|---|
| Introduction to the Manuals. . . . .      | 8 |
| Marks and Symbols. . . . .                | 8 |
| Descriptions Used in this Manual. . . . . | 8 |
| Operating System References. . . . .      | 9 |

### Important Instructions

|  |    |
|--|----|
| Safety Instructions. . . . .   | 10 |
| Printer Advisories and Warnings. . . . .   | 10 |
| Advisories and Warnings for Setting Up/<br>Using the Printer. . . . .                | 11 |
| Advisories and Warnings for Using the<br>Printer with a Wireless Connection. . . . . | 12 |
| Advisories and Warnings for Using Memory<br>Cards. . . . .                           | 12 |
| Advisories and Warnings for Using the LCD<br>Screen. . . . .                         | 12 |
| Protecting Your Personal Information. . . . .  | 12 |

### Printer Basics

|                                   |    |
|-----------------------------------|----|
| Part Names and Functions. . . . . | 13 |
| Control Panel. . . . .            | 15 |
| Buttons. . . . .                  | 15 |
| Guide to the LCD Screen. . . . .  | 16 |
| Menu Options. . . . .             | 17 |
| Copy Mode. . . . .                | 17 |
| Print Photos Mode. . . . .        | 19 |
| Scan Mode. . . . .                | 20 |
| Wi-Fi Setup Mode. . . . .         | 21 |
| Quiet Mode. . . . .               | 21 |
| Personal Stationery Mode. . . . . | 21 |
| Setup Mode. . . . .               | 21 |

### Loading Paper

|  |    |
|--|----|
| Paper Handling Precautions. . . . .          | 24 |
| Available Paper and Capacities. . . . .      | 25 |
| List of Paper Types. . . . .                 | 26 |
| Loading Paper in the Paper Cassette. . . . . | 27 |

### Placing Originals on the Scanner Glass

|                                  |    |
|----------------------------------|----|
| Placing Other Originals. . . . . | 34 |
|----------------------------------|----|

### Inserting a Memory Card

|   |    |
|---|----|
| Supported Memory Cards. . . . .               | 35 |
| Inserting and Removing a Memory Card. . . . . | 35 |

### Printing

|   |    |
|---|----|
| Printing from the Control Panel. . . . .                              | 37 |
| Printing Photos by Selecting from a Memory<br>Card. . . . .           | 37 |
| Printing Photos from a Memory Card with<br>Handwritten Notes. . . . . | 38 |
| Printing Original Writing Paper and Calendars. . . . .                | 40 |
| Printing Photos Using Other Features. . . . .                         | 40 |
| Printing from a Computer. . . . .                                     | 41 |
| Printing Basics - Windows. . . . .                                    | 41 |
| Printing Basics - Mac OS X. . . . .                                   | 43 |
| Printing on 2-Sides. . . . .  | 45 |
| Printing Several Pages on One Sheet. . . . .                          | 47 |
| Printing to Fit the Paper Size. . . . .                               | 48 |
| Printing Multiple Files Together (for<br>Windows Only). . . . .       | 49 |
| Enlarged Printing and Making Posters (for<br>Windows Only). . . . .   | 50 |
| Printing Using Advanced Features. . . . .                             | 56 |
| Printing Photos Using Epson Easy Photo Print. . . . .                 | 58 |
| Printing from Smart Devices. . . . .                                  | 59 |
| Using Epson iPrint. . . . .   | 59 |
| Using AirPrint. . . . .   | 60 |
| Printing from a Digital Camera. . . . .                               | 61 |
| Printing from a Digital Camera Connected<br>Wirelessly. . . . .       | 61 |
| Canceling Printing. . . . .   | 62 |
| Canceling Printing - Printer Button. . . . .                          | 62 |
| Canceling Printing - Windows. . . . .                                 | 62 |
| Canceling Printing - Mac OS X. . . . .                                | 62 |

### Copying

|                         |    |
|-------------------------|----|
| Copying Basics. . . . . | 63 |
| Copying Photos. . . . . | 63 |

## Contents

### Scanning

|   |    |
|---|----|
| Scanning Using the Control Panel. . . . . | 65 |
| Scanning to a Memory Card. . . . .        | 65 |
| Scanning to a Computer. . . . .           | 65 |
| Scanning to a Computer (WSD). . . . .     | 66 |
| Scanning from a Computer. . . . .         | 66 |
| Scanning Basics. . . . .                  | 66 |
| Scanning Using Advanced Features. . . . . | 69 |
| Scanning from Smart Devices. . . . .      | 72 |

### Replacing Ink Cartridges

|  |    |
|--|----|
| Checking the Ink Levels. . . . .   | 74 |
| Checking the Ink Levels - Control Panel. . . . .                           | 74 |
| Checking the Ink Levels - Windows. . . . .                                 | 74 |
| Checking the Ink Levels - Mac OS X. . . . .                                | 74 |
| Ink Cartridge Codes. . . . .   | 74 |
| Ink Cartridge Handling Precautions. . . . .                                | 75 |
| Replacing Ink Cartridges. . . . .  | 77 |
| Temporarily Printing with Black Ink. . . . .                               | 80 |
| Temporarily Printing with Black Ink - Windows. . . . .                     | 81 |
| Temporarily Printing with Black Ink - Mac OS X. . . . .                    | 82 |
| Conserving Black Ink when the Black Ink Is Low (for Windows Only). . . . . | 83 |

### Improving Print and Scan Quality

|   |    |
|---|----|
| Checking and Cleaning the Print Head. . . . .                 | 84 |
| Checking and Cleaning the Print Head - Control Panel. . . . . | 84 |
| Checking and Cleaning the Print Head - Windows. . . . .       | 85 |
| Checking and Cleaning the Print Head - Mac OS X. . . . .      | 85 |
| Aligning the Print Head. . . . .                              | 86 |
| Aligning the Print Head - Control Panel. . . . .              | 86 |
| Aligning the Print Head - Windows. . . . .                    | 86 |
| Aligning the Print Head - Mac OS X. . . . .                   | 87 |
| Cleaning the Paper Path. . . . .                              | 87 |
| Cleaning the Scanner Glass. . . . .                           | 87 |

### Applications and Network Service Information

|  |    |
|--|----|
| Epson Connect Service. . . . .               | 89 |
| Web Config. . . . .                          | 89 |
| Running Web Config on a Web Browser. . . . . | 89 |
| Running Web Config on Windows. . . . .       | 90 |

|   |     |
|---|-----|
| Running Web Config on Mac OS X. . . . .       | 90  |
| Necessary Applications. . . . .               | 90  |
| Windows Printer Driver. . . . .               | 90  |
| Mac OS X Printer Driver. . . . .              | 94  |
| EPSON Scan (Scanner Driver). . . . .          | 97  |
| Epson Event Manager. . . . .                  | 97  |
| Epson Easy Photo Print. . . . .               | 98  |
| E-Web Print (for Windows Only). . . . .       | 98  |
| Easy Photo Scan. . . . .                      | 98  |
| EPSON Software Updater. . . . .               | 99  |
| Uninstalling Applications. . . . .            | 99  |
| Uninstalling Applications - Windows. . . . .  | 99  |
| Uninstalling Applications - Mac OS X. . . . . | 100 |
| Installing Applications. . . . .              | 100 |
| Updating Applications and Firmware. . . . .   | 101 |

### Solving Problems

|   |     |
|---|-----|
| Checking the Printer Status. . . . .  | 102 |
| Checking Error Codes on the LCD Screen. . . . .                                   | 102 |
| Checking the Printer Status - Windows. . . . .                                    | 103 |
| Checking Printer Status - Mac OS X. . . . .                                       | 104 |
| Removing Jammed Paper. . . . .  | 104 |
| Removing Jammed Paper from the Paper Cassette. . . . .                            | 104 |
| Removing Jammed Paper from Inside the Printer. . . . .                            | 105 |
| Removing Jammed Paper from the Rear Cover. . . . .                                | 107 |
| Paper Does Not Feed Correctly. . . . .  | 108 |
| Power and Control Panel Problems. . . . .   | 109 |
| Power Does Not Turn On. . . . .   | 109 |
| Lights Came On and then Went Out. . . . .   | 109 |
| Power Does Not Turn Off. . . . .  | 109 |
| LCD Screen Gets Dark. . . . .   | 109 |
| Printer Does Not Print. . . . .   | 109 |
| Printout Problems. . . . .  | 110 |
| Print Quality Is Poor. . . . .  | 110 |
| Copy Quality Is Poor. . . . .   | 112 |
| An Image of the Reverse Side of the Original Appears in the Copied Image. . . . . | 112 |
| The Position, Size, or Margins of the Printout Are Incorrect. . . . .             | 112 |
| Paper Is Smearred or Scuffed. . . . .   | 113 |
| Printed Characters Are Incorrect or Garbled. . . . .                              | 114 |
| The Printed Image Is Inverted. . . . .  | 114 |
| The Printout Problem Could Not be Cleared. . . . .                                | 114 |
| Printing Is Too Slow. . . . .   | 114 |
| Cannot Start Scanning. . . . .  | 115 |

## Contents

|  |     |
|--|-----|
| Cannot Start Scanning when Using the Control Panel. . . . .                        | 116 |
| Scanned Image Problems. . . . .  | 116 |
| Scan Quality Is Poor. . . . .  | 116 |
| Characters Are Blurred. . . . .  | 116 |
| An Image of the Reverse Side of the Original Appears in the Scanned Image. . . . . | 117 |
| Moire (Cross-Hatch) Patterns Appear in the Scanned Image. . . . .                  | 117 |
| Scanning Area or Direction Is Not Correct. . . . .                                 | 117 |
| The Scanned Image Problem Could Not be Cleared. . . . .                            | 118 |
| Other Scanning Problems. . . . .   | 118 |
| Cannot Scan in Full Auto Mode in EPSON Scan. . . . .                               | 118 |
| Thumbnail Preview Does Not Work Properly. . . . .                                  | 118 |
| Scanning Is Too Slow. . . . .  | 118 |
| Scanning Stops when Scanning to PDF/Multi-TIFF. . . . .                            | 119 |
| Other Problems. . . . .  | 119 |
| Slight Electric Shock when Touching the Printer. . . . .                           | 119 |
| Operation Sounds Are Loud. . . . .   | 119 |
| Cannot Save the Data to a Memory Card. . . . .                                     | 119 |
| Application Is Blocked by a Firewall (for Windows Only). . . . .                   | 120 |
| "?" Is Displayed on the Photo Selection Screen. . . . .                            | 120 |

## Appendix

|  |     |
|--|-----|
| Technical Specifications. . . . .                | 121 |
| Printer Specifications. . . . .                  | 121 |
| Scanner Specifications. . . . .                  | 122 |
| Interface Specifications. . . . .                | 122 |
| Wi-Fi Specifications. . . . .                    | 122 |
| Security Protocol. . . . .                       | 123 |
| Supported Third Party Services. . . . .          | 123 |
| External Storage Device Specifications. . . . .  | 123 |
| Dimensions. . . . .                              | 124 |
| Electrical Specifications. . . . .               | 125 |
| Environmental Specifications. . . . .            | 125 |
| System Requirements. . . . .                     | 126 |
| Regulatory Information. . . . .                  | 126 |
| Standards and Approvals. . . . .                 | 126 |
| Restrictions on Copying. . . . .                 | 127 |
| Transporting the Printer. . . . .                | 128 |
| Accessing a Memory Card From a Computer. . . . . | 129 |
| Where to Get Help. . . . .                       | 130 |
| Technical Support Web Site. . . . .              | 130 |
| Contacting Epson Support. . . . .                | 131 |

# About This Manual

---

## Introduction to the Manuals

The latest versions of the following manuals are available from the Epson support website.

<http://www.epson.eu/Support> (Europe)

<http://support.epson.net/> (outside Europe)

Start Here (paper manual)

Provides you with information on setting up the printer and installing the software.

User's Guide (digital manual)

This manual. Provides instructions on using the printer, replacing ink cartridges, maintenance, and solving problems.

Network Guide (digital manual)

Provides information on network settings and solving problems when using the printer on a network.

As well as the manuals above, see the help included in the various Epson software applications.

---

## Marks and Symbols



**Caution:**

*Instructions that must be followed carefully to avoid bodily injury.*



**Important:**

*Instructions that must be observed to avoid damage to your equipment.*

**Note:**

*Instructions containing useful tips and restrictions on printer operation.*

**➔** Related Information

Links to related sections.

---

## Descriptions Used in this Manual

- Screenshots of the printer driver and the EPSON Scan (scanner driver) screens are from Windows 8.1 or Mac OS X v10.9.x. The content displayed on the screens varies depending on the model and situation.
- Illustrations of the printer used in this manual are examples only. Although there may be slight differences depending on the model, the method of operation is the same.
- Some of the menu items on the LCD screen vary depending on the model and settings.



---

## Operating System References

### Windows

In this manual, terms such as "Windows 8.1", "Windows 8", "Windows 7", "Windows Vista", and "Windows XP" refer to the following operating systems. Additionally, "Windows" is used to refer to all versions.

- Microsoft® Windows® 8.1 operating system
- Microsoft® Windows® 8 operating system
- Microsoft® Windows® 7 operating system
- Microsoft® Windows Vista® operating system
- Microsoft® Windows® XP operating system
- Microsoft® Windows® XP Professional x64 Edition operating system

### Mac OS X

In this manual, "Mac OS X v10.9.x" refers to "OS X Mavericks" and "Mac OS X v10.8.x" refers to "OS X Mountain Lion". Additionally, "Mac OS X" is used to refer to "Mac OS X v10.9.x", "Mac OS X v10.8.x", "Mac OS X v10.7.x" and "Mac OS X v10.6.x".

# Important Instructions

---

## Safety Instructions

Read and follow these instructions to ensure safe use of this printer. Make sure you keep this manual for future reference. Also, be sure to follow all warnings and instructions marked on the printer.

- Use only the power cord supplied with the printer and do not use the cord with any other equipment. Use of other cords with this printer or the use of the supplied power cord with other equipment may result in fire or electric shock.
- Be sure your AC power cord meets the relevant local safety standard.
- Never disassemble, modify, or attempt to repair the power cord, plug, printer unit, scanner unit, or options by yourself, except as specifically explained in the printer's manuals.
- Unplug the printer and refer servicing to qualified service personnel under the following conditions:  
The power cord or plug is damaged; liquid has entered the printer; the printer has been dropped or the casing damaged; the printer does not operate normally or exhibits a distinct change in performance. Do not adjust controls that are not covered by the operating instructions.
- Place the printer near a wall outlet where the plug can be easily unplugged.
- Do not place or store the printer outdoors, near excessive dirt or dust, water, heat sources, or in locations subject to shocks, vibrations, high temperature or humidity.
- Take care not to spill liquid on the printer and not to handle the printer with wet hands.
- Keep the printer at least 22 cm away from cardiac pacemakers. Radio waves from this printer may adversely affect the operation of cardiac pacemakers.
- If the LCD screen is damaged, contact your dealer. If the liquid crystal solution gets on your hands, wash them thoroughly with soap and water. If the liquid crystal solution gets into your eyes, flush them immediately with water. If discomfort or vision problems remain after a thorough flushing, see a doctor immediately.
- Be careful when you handle used ink cartridges, as there may be some ink around the ink supply port.
  - If ink gets on your skin, wash the area thoroughly with soap and water.
  - If ink gets into your eyes, flush them immediately with water. If discomfort or vision problems continue after a thorough flushing, see a doctor immediately.
  - If ink gets into your mouth, see a doctor right away.
- Do not disassemble the ink cartridge; otherwise ink may get into your eyes or on your skin.
- Do not shake ink cartridges too vigorously and do not drop them. Also, be careful not to squeeze them or tear their labels. Doing so may cause ink leakage.
- Keep ink cartridges out of the reach of children.



---

## Printer Advisories and Warnings

Read and follow these instructions to avoid damaging the printer or your property. Make sure you keep this manual for future reference.

## Important Instructions

### Advisories and Warnings for Setting Up/Using the Printer

- Do not block or cover the vents and openings in the printer.
- Use only the type of power source indicated on the printer's label.
- Avoid using outlets on the same circuit as photocopiers or air control systems that regularly switch on and off.
- Avoid electrical outlets controlled by wall switches or automatic timers.
- Keep the entire computer system away from potential sources of electromagnetic interference, such as loudspeakers or the base units of cordless telephones.
- The power-supply cords should be placed to avoid abrasions, cuts, fraying, crimping, and kinking. Do not place objects on top of the power-supply cords and do not allow the power-supply cords to be stepped on or run over. Be particularly careful to keep all the power-supply cords straight at the ends and the points where they enter and leave the transformer.
- If you use an extension cord with the printer, make sure that the total ampere rating of the devices plugged into the extension cord does not exceed the cord's ampere rating. Also, make sure that the total ampere rating of all devices plugged into the wall outlet does not exceed the wall outlet's ampere rating.
- If you plan to use the printer in Germany, the building installation must be protected by a 10 or 16 amp circuit breaker to provide adequate short-circuit protection and over-current protection for the printer.
- When connecting the printer to a computer or other device with a cable, ensure the correct orientation of the connectors. Each connector has only one correct orientation. Inserting a connector in the wrong orientation may damage both devices connected by the cable.
- Place the printer on a flat, stable surface that extends beyond the base of the printer in all directions. The printer will not operate properly if it is tilted at an angle.
- When storing or transporting the printer, avoid tilting it, placing it vertically, or turning it upside down; otherwise ink may leak.
- Allow space above the printer so that you can fully raise the document cover.
- Leave enough space in front of the printer for the paper to be fully ejected.
- Avoid places subject to rapid changes in temperature and humidity. Also, keep the printer away from direct sunlight, strong light, or heat sources.
- Do not insert objects through the slots in the printer.
- Do not put your hand inside the printer during printing.
- Do not touch the white flat cable inside the printer.
- Do not use aerosol products that contain flammable gases inside or around the printer. Doing so may cause fire.
- Do not move the print head by hand; otherwise, you may damage the printer.
- Be careful not to trap your fingers when closing the scanner unit.
- Do not press too hard on the scanner glass when placing the originals.
- Always turn the printer off using the  button. Do not unplug the printer or turn off the power at the outlet until the  light stops flashing.
- Before transporting the printer, make sure that the print head is in the home (far right) position and the ink cartridges are in place.
- If you are not going to use the printer for a long period, be sure to unplug the power cord from the electrical outlet.

## Important Instructions

### Advisories and Warnings for Using the Printer with a Wireless Connection

- ❑ Radio waves from this printer may negatively affect the operation of medical electronic equipment, causing them to malfunction. When using this printer inside medical facilities or near medical equipment, follow directions from the authorized personnel representing the medical facilities, and follow all posted warnings and directions on the medical equipment.
- ❑ Radio waves from this printer may negatively affect the operation of automatically controlled devices such as automatic doors or fire alarms, and could lead to accidents due to malfunction. When using this printer near automatically controlled devices, follow all posted warnings and directions on these devices.

### Advisories and Warnings for Using Memory Cards

- ❑ Do not remove a memory card or turn off the printer while the memory card light is flashing.
- ❑ The methods for using memory cards vary according to card type. Be sure to refer to the manual packaged with your memory card for details.
- ❑ Use only memory cards compatible with the printer.

#### Related Information

➔ [“Supported Memory Card Specifications” on page 123](#)

### Advisories and Warnings for Using the LCD Screen

- ❑ The LCD screen may contain a few small bright or dark spots, and because of its features it may have an uneven brightness. These are normal and do not indicate that it is damaged in any way.
- ❑ Only use a dry, soft cloth for cleaning. Do not use liquid or chemical cleaners.
- ❑ The exterior cover of the LCD screen could break if it receives a heavy impact. Contact your dealer if the screen's surface chips or cracks, and do not touch or attempt to remove the broken pieces.

---

## Protecting Your Personal Information

When you give the printer to someone else or dispose of it, erase all the personal information stored in the printer's memory by selecting **Setup** > **Restore Default Settings** > **All Settings** on the control panel.

# Printer Basics

## Part Names and Functions

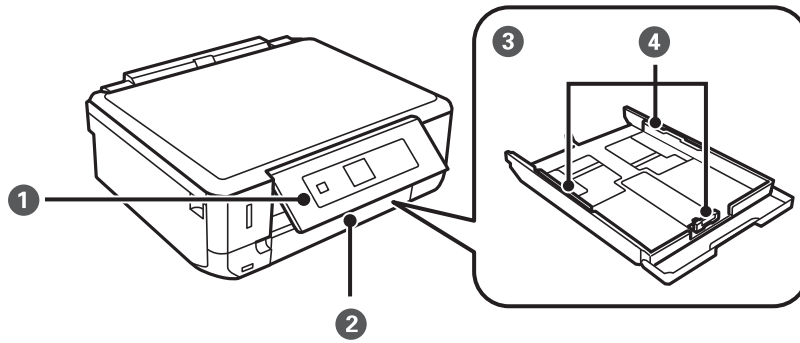

|   |                |   |
|---|----------------|---|
| 1 | Control Panel  | Operates the printer.   |
| 2 | Front cover    | Open to load paper in the paper cassette.                                   |
| 3 | Paper cassette | Loads paper.  |
| 4 | Edge guide     | Feeds the paper straight into the printer. Slide to the edges of the paper. |

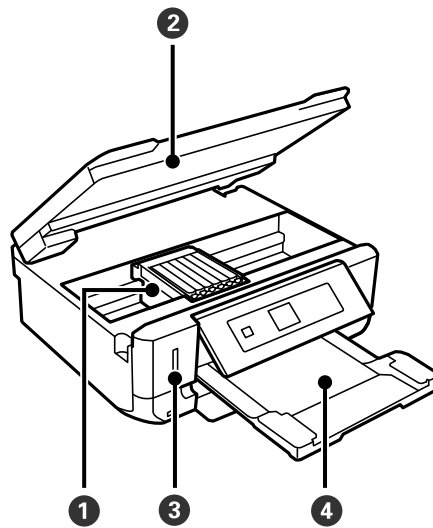

|   |                      |  |
|---|----------------------|--|
| 1 | Ink cartridge holder | Install the ink cartridges. Ink is ejected from the print head nozzles underneath.   |
| 2 | Scanner unit         | Scans placed originals. Open to replace ink cartridges or to remove jammed paper. This unit should usually be kept closed. |
| 3 | Memory card slot     | Insert a memory card.  |

**Printer Basics**

|   |             |  |
|---|-------------|--|
| 4 | Output tray | Holds the ejected paper. Pull out manually and push it back in to store. |
|---|-------------|--|

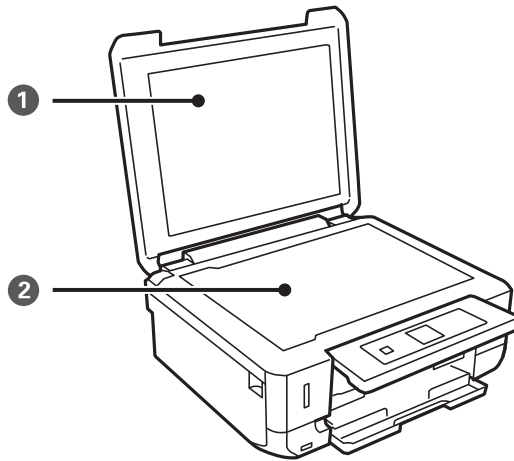

|   |                |                                       |
|---|----------------|---------------------------------------|
| 1 | Document cover | Blocks external light while scanning. |
| 2 | Scanner glass  | Place the originals.                  |

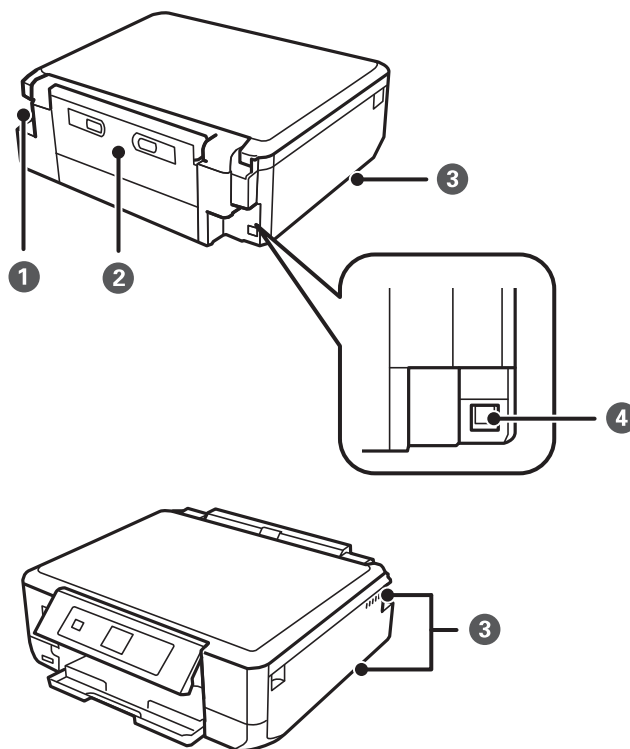

|   |            |                                    |
|---|------------|------------------------------------|
| 1 | AC inlet   | Connects the power cord.           |
| 2 | Rear cover | Remove when removing jammed paper. |

### Printer Basics

|   |          |  |
|---|----------|--|
| 3 | Vent     | Releases heat from the inside of the printer. Vents are on the bottom right, bottom left, and on the right-hand side. Do not cover the vents when placing the printer. |
| 4 | USB port | Connects a USB cable.  |



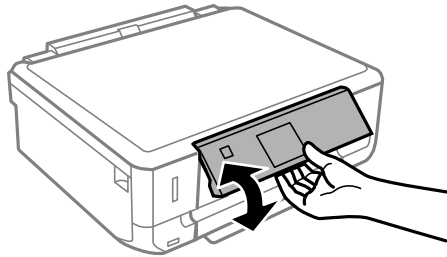

## Control Panel

You can change the angle of the control panel.

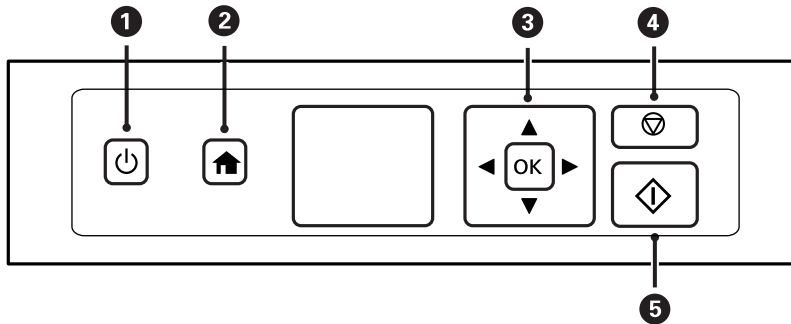

## Buttons



|   |   |  |
|---|---|--|
| 1 |  | Turns the printer on or off.<br>Do not turn off while the power light is flashing (while the printer is operating or processing data).<br>Unplug the power cord when the power light is off. |
| 2 |  | Displays the home screen.  |
| 3 |  | Use the ▲▼◀▶ buttons to select a menu, and press the OK button to run the selected menu.   |
| 4 |  | Stops the current operation or returns to the previous screen.   |
| 5 |  | Starts an operation such as printing or copying.   |

Printer Basics

Guide to the LCD Screen

Menus and messages are displayed on the LCD screen. Select a menu or setting by pressing the ▲ ▼ ◀ ▶ buttons.

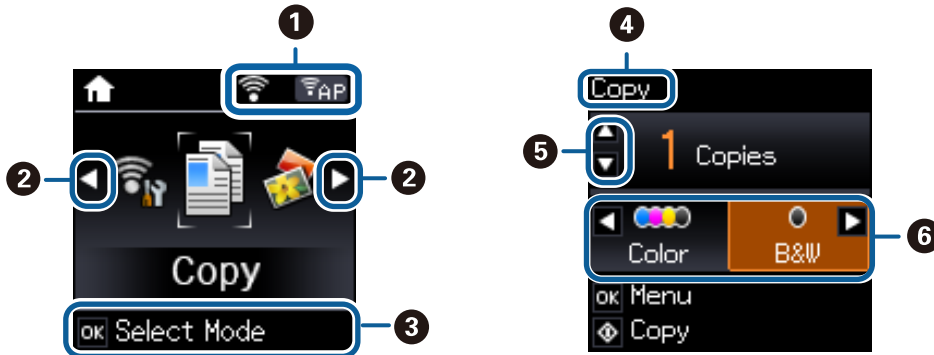

|   |   |
|---|---|
| 1 | Icons that show the network status are displayed.   |
|   | Indicates a problem with the printer's wireless (Wi-Fi) network connection, or that the printer is searching for a wireless (Wi-Fi) network connection.   |
|   | Indicates that the printer is connected to a wireless (Wi-Fi) network.<br>The number of bars indicates the signal strength of the connection. The more bars there are, the stronger the connection. |
|   | Indicates that the printer is connected to a wireless (Wi-Fi) network in Ad Hoc mode  |
|   | Indicates that a wireless (Wi-Fi) network is disabled, or that the printer is connecting.   |
|   | Indicates that the printer is connected to a wireless (Wi-Fi) network in Simple AP mode.  |
|   | Indicates that the printer is connected to a wireless (Wi-Fi) network in Wi-Fi Direct mode.   |
|   | Indicates that Wi-Fi Direct is disabled, or that the printer is connecting.   |
| 2 | When ◀ and ▶ are displayed, you can scroll right or left.   |
| 3 | Available buttons are displayed. In this example, you can proceed to the selected menu by pressing the OK button.   |
| 4 | This is the name of the screen displayed.   |
| 5 | Available buttons are displayed. In this example, you can set the number of copies by pressing the ▲ or ▼ button.   |
| 6 | Available buttons are displayed. In this example, you can select <b>Color</b> or <b>B&amp;W</b> by pressing the ◀ or ▶ button.  |



# Menu Options

## Copy Mode

### Scan Mode Top Screen

| Menu                 | Settings and Explanations     |
|----------------------|-------------------------------|
| The number of copies | Enter the number of copies.   |
| Color/B&W            | Select the color for copying. |

### Menu Options for Copy

To access the following menus, press the OK button on the **Copy** mode top screen. Select **Settings** using the ◀ or ▶ button, press the OK button, and then press the ▼ button on the next screen.

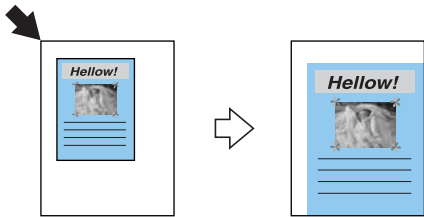
| Menu            | Settings and Explanations  |
|-----------------|--|
| Density         | Set the density of your copies. Increase the level of density when the copying results are too light. Decrease the level of density when ink smears.   |
| 2-Sided Copying | 1>1-Sided<br>Copies one side of an original onto a single side of paper.   |
|                 | 1>2-Sided<br>Copies two single-sided originals onto both sides of a single sheet of paper.   |
| Layout          | With Border<br>Copies with margins around the edges.   |
|                 | Borderless<br>Copies without margins around the edges. The image is enlarged a little to remove borders from the edges of the paper.   |
|                 | A4, 2-up Copy<br>Copies two single-sided originals onto a single sheet of A4 size paper in 2-up layout.  |
|                 | A4, Book/2-up<br>Copies two facing pages of a book and so on onto a single sheet of A4 size paper in 2-up layout.  |
|                 | Book/2-Sided<br>Copies two separate pages of a book and so on onto both sides of a single sheet of paper. Only available when <b>1&gt;2-Sided</b> is selected as the 2-sided copying setting.  |
| Reduce/Enlarge  | <p>Enlarges or reduces the original.</p> <p><b>Auto Fit:</b> All areas that include text and images in the original as well as the space from the corner mark are scanned, and the scanned data is enlarged or reduced to fit to the selected paper size.</p>  <p><b>Custom Size (%)</b>: Specifies the magnification to enlarge or reduce the original.</p> |

## Printer Basics

| Menu             | Settings and Explanations  |
|------------------|--|
| Paper Size       | Select the paper size you loaded.  |
| Paper Type       | Select the paper type you loaded.  |
| Document Type    | Select the type of your original.  |
| Quality          | Select the quality for copying.<br><b>Draft:</b> Provides faster printing, but the printouts may be faint.<br><b>Best:</b> Provides higher quality printing, but the printing speed may be slower. |
| Doc. Orientation | Select the orientation of your original.   |
| Binding Margin   | Select the binding position of the copies.   |
| Expansion        | With borderless printing, the image is enlarged a little to remove borders from the edges of the paper. Select how much to enlarge the image.  |
| Dry Time         | Select the drying time for 2-sided copying. Increase the level of drying time when ink smears.   |

### Copy/Restore Photos

You can copy your printed photos. For more details, see the page that describes the procedure for copying photos.

| Menu              | Settings and Explanations            |
|-------------------|--------------------------------------|
| Color Restoration | Restores the colors in faded photos. |

### Menu Options for Copy/Restore Photos

To access the following menus, press the OK button while a scanned photo is displayed, and then press the ▼ button on the next screen.

| Menu       | Settings and Explanations   |
|------------|---|
| Paper Size | Select the paper size you loaded.   |
| Paper Type | Select the paper type you loaded.   |
| Borderless | Copies without margins around the edges. The image is enlarged a little to remove borders from the edges of the paper.  |
| Expansion  | With borderless printing, the image is enlarged a little to remove borders from the edges of the paper. Select how much to enlarge the image.                               |
| Enhance    | Selecting <b>PhotoEnhance</b> produces sharper images and more vivid colors by automatically adjusting the contrast, saturation, and brightness of the original image data. |
| Filter     | Prints in monochrome.   |
| Crop/Zoom  | Enlarges a part of the photo to be printed.   |

### Related Information

➔ [“Copying Photos” on page 63](#)

## Printer Basics

### Print Photos Mode

| Menu                      | Settings and Explanations   |
|---------------------------|---|
| Select Photos             | You can select the photos on a memory card that you want to print while viewing them on the LCD screen.   |
| Print Photo Greeting Card | You can add handwritten text to a photo or print as photo stickers. For more details, see the page that explains the procedure for printing a greeting card.  |
| Photo Layout Sheet        | <p>You can print your photos in various layouts, such as printing multiple photos on a sheet of photo paper.</p> <p><b>20-up:</b> The serial number or date is printed below each photo.</p> <p><b>Sticker 16-up:</b> Select when printing on photo stickers.</p> <p><b>P.I.F.</b> is displayed if you have a P.I.F. frame on your memory card.</p> |

#### Menus of paper and print settings

To access the following menus, press the OK button when a photo is displayed on the screen, and then press the ▼ button on the next screen.

| Menu          | Settings and Explanations  |   |
|---------------|--|---|
| Paper Size    | Select the paper size you loaded.  |   |
| Paper Type    | Select the paper type you loaded.  |   |
| Borderless    | Prints without margins around the edges. The image is enlarged a little to remove borders from the edges of the paper.   |   |
| Quality       | Select the print quality. Selecting <b>Best</b> provides higher quality printing, but the printing speed may be slower.  |   |
| Expansion     | With borderless printing, the image is enlarged a little to remove borders from the edges of the paper. Select how much to enlarge the image.  |   |
| Date          | <p>Select a date format to print photos with a date. The date is not printed for some layouts or if date information is not included in the photo data.</p> <p>The date is printed automatically when selecting <b>20-up</b>. The date used is the date the photo was taken or the date you saved the photo data.</p>  |   |
| Fit Frame     | Trims your photo. This may not be available for panorama photos. The photo is always trimmed in <b>Borderless, Upper 1/2, or Lower 1/2</b> printing.   |   |
|               | On   | Crops the top and bottom or left and right of the image.              |
|               | Off  | Creates margins on the left and right or top and bottom of the image. |
| Bidirectional | Prints while the print head moves to the left and to the right. Selecting <b>Off</b> (prints while moving in one direction) provides higher quality printing, but the printing speed may be slower.  |   |
| Enhance       | <p>Select one of the image adjustment options.</p> <p><b>PhotoEnhance:</b> Produces sharper images and more vivid colors by automatically adjusting the contrast, saturation, and brightness of the original image data.</p> <p><b>P.I.M.:</b> Adjusts the image based on the print information provided by a digital camera compatible with PRINT Image Matching.</p> |   |

## Printer Basics

| Menu            | Settings and Explanations  |
|-----------------|--|
| Scene Detection | Available when selecting <b>PhotoEnhance</b> as the <b>Enhance</b> setting. Improves the image quality for photos of people, landscapes, and night scenes.                                 |
| Fix Red-Eye     | Fixes red-eye in photos. Corrections are not applied to the original file, only to the printouts. Depending on the type of photo, parts of the image other than the eyes may be corrected. |
| Filter          | Prints in sepia or monochrome.   |
| Brightness      | Adjusts the brightness of the image.   |
| Contrast        | Adjusts the difference between the brightness and darkness.  |
| Sharpness       | Enhances or defocuses the outline of the image.  |
| Saturation      | Adjusts the vividness of the image.  |

### Related Information

➔ [“Printing Photos from a Memory Card with Handwritten Notes” on page 38](#)

## Scan Mode

| Menu                | Settings and Explanations   |
|---------------------|---|
| To Memory           | Scans your original and saves the scanned image to the memory card inserted into the printer. You can change the format, color, or scan area. |
| To Computer (JPEG)  | Saves the scanned image to a computer in JPEG format.   |
| To Computer (PDF)   | Saves the scanned image to a computer in PDF format.  |
| To Computer (Email) | Attaches the scanned image to an email.   |
| To Computer (WSD)   | Stores scanned data on a network-connected computer running an English version of Windows 8.1, Windows 8, Windows 7, or Windows Vista.        |

### Menu Options for Scan

The following menus are only available for **To Memory**.

| Menu       | Settings and Explanations   |
|------------|---|
| Format     | Select the format in which to save the scanned image.   |
| Color      | Select whether to scan in color or in monochrome.   |
| Scan Area  | Select the scan area.<br><b>Auto Cropping:</b> Crops the white space around the text or image when scanning.<br><b>Max Area:</b> Scans at the maximum scan area of the scanner glass.<br>Select this setting and scan again if the edges of the scanned image are cropped when <b>A4</b> is selected. |
| Document   | Select the type of your original.   |
| Resolution | Select the scanning resolution.   |

## Printer Basics

| Menu             | Settings and Explanations  |
|------------------|--|
| Contrast         | Select the contrast of the scanned image.  |
| Doc. Orientation | Select the orientation of your original. This is only available when PDF is selected as the save format. |

## Wi-Fi Setup Mode

See the *Network Guide* to make the following settings.

| Menu               | Settings and Explanations   |
|--------------------|---|
| Wi-Fi Setup Wizard | Select an SSID, enter a password, and then connect the printer to a wireless (Wi-Fi) network.   |
| Push Button (WPS)  | Connect the printer to a wireless network by using the WPS button on your wireless router.  |
| PIN Code (WPS)     | In the wireless router utility, enter the PIN code displayed on the printer's screen and connect the printer to a wireless (Wi-Fi) network.   |
| Wi-Fi Auto Connect | Easily connect the printer to a wireless (Wi-Fi) network using a computer connected to the wireless router. By simply following the on-screen instructions on the computer, you can make the network settings without entering an SSID or security key. |
| Disable Wi-Fi      | Disables the connection by turning the Wi-Fi off without deleting the network information. To enable the connection, set up the wireless (Wi-Fi) network again.   |
| Wi-Fi Direct Setup | Connects the printer to a wireless (Wi-Fi) network without a wireless router.   |

## Quiet Mode

Select **Quiet Mode** using the ◀ or ▶ button on the home screen, and then press the OK button. Prints quietly when enabled. However, the printing speed may be slower.

## Personal Stationery Mode

| Menu           | Settings and Explanations  |
|----------------|--|
| Lined Papers   | Prints some types of lined paper, graph paper, or music paper on A4 size paper.  |
| Writing Papers | Prints some types of writing paper on A4 size paper with a photo from the memory card set as the background. The photo is printed lightly so that it can be easily written on. |
| Calendar       | Prints a weekly or monthly calendar on A4 size paper. Select the period for the monthly calendar.  |

## Setup Mode

| Menu       | Settings and Explanations  |
|------------|--|
| Ink Levels | Displays the approximate levels of the ink cartridges. When an ! icon is displayed, the ink cartridge is running low. When a X mark is displayed, the ink cartridge is expended. |

## Printer Basics

| Menu                        | Settings and Explanations   |   |
|-----------------------------|---|---|
| Maintenance                 | Nozzle Check  | Prints a pattern to check if the print head nozzles are clogged.  |
|                             | Head Cleaning   | Cleans clogged nozzles in the print head.   |
|                             | Head Alignment  | Adjusts the print head to improve print quality.  |
|                             | Ink Cartridge(s) Replacement  | Use this feature to replace the ink cartridges before the ink is expended.  |
| Printer Setup               | Paper Source Setting  | Paper Setup<br>Select the paper size and paper type you loaded.   |
|                             |   | Paper Configuration<br>Automatically displays the paper settings screen when paper is loaded. AirPrint is not available when disabled. In addition, the printer does not warn you even if the paper settings do not match the paper you loaded.   |
|                             | Stickers  | Adjusts the printing position of a photo sticker by moving up, down, left, or right to fit.   |
|                             | Quiet Mode  | Prints quietly when enabled. However, the print speed may be slower.  |
|                             | Power Off Timer   | Turns the printer off automatically when a specified time has passed and no operations have been performed. You can adjust the time before power management is applied. Any increase will affect the product's energy efficiency. Please consider the environment before making any change. |
|                             | Sleep Timer   | Select the time period before the printer enters sleep mode (energy saving mode) when no operations are performed. The LCD screen turns black when the set time passes.   |
|                             | Language  | Select the display language.  |
| Network Settings            | Print Status Sheet  | Prints a network status sheet.  |
|                             | Wi-Fi Setup   | <b>Wi-Fi Setup</b> on the home screen is a shortcut to access this menu. For details on each menu, see the <b>Wi-Fi Setup</b> table.  |
|                             | Network Connection Check  | Checks the status of the network connection and prints the network connection check report. If there are any problems with the connection, see the check report to solve the problem. See the <i>Network Guide</i> for more details.  |
| Epson Connect Services      | You can suspend or resume the Epson Connect or Google Cloud Print service, or cancel using the services (restore the default settings). See the following for details.  |   |
| Google Cloud Print Services | <a href="https://www.epsonconnect.com/">https://www.epsonconnect.com/</a><br><a href="http://www.epsonconnect.eu">http://www.epsonconnect.eu</a> (Europe only)  |   |
| File Sharing Setup          | Select the connection method between the printer and the computer when giving write access to the memory card inserted in the printer. Read and write access is given to the computer with the priority connection. Only read access is given to other computers. |   |
| External Device Setup       | Change the print settings to print directly from an external device such as a digital camera.   |   |
| Guide Functions             | Paper Setting Alert   | Warns you when the paper settings do not match the paper you loaded.  |

## Printer Basics

| Menu                     | Settings and Explanations                       |
|--------------------------|---|
| Restore Default Settings | Resets the selected settings to their defaults. |

### Related Information

➔ [“Wi-Fi Setup Mode” on page 21](#)

# Loading Paper

## Paper Handling Precautions

- ❑ Read the instruction sheets supplied with the paper.
- ❑ Fan and align the edges of the paper before loading. Do not fan or curl photo paper. Doing so may damage the printable side.

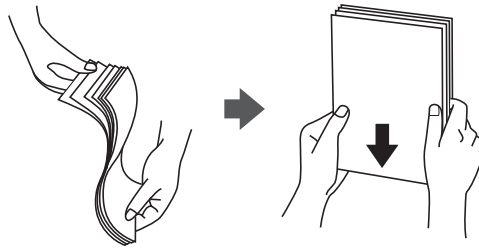

- ❑ If the paper is curled, flatten it or curl it slightly in the opposite direction before loading. Printing on curled paper may cause paper jams and smears on the printout.

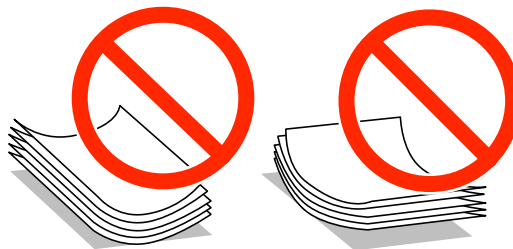

- ❑ Do not use paper that is wavy, torn, cut, folded, damp, too thick, too thin, or paper that has stickers stuck to it. Using these types of paper causes paper jams and smears on the printout.
- ❑ Fan and align the edges of the envelopes before loading. When the stacked envelopes are puffed up with air, press them down to flatten them before loading.

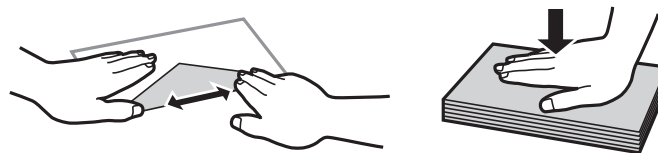

- ❑ Do not use envelopes that are curled or folded. Using these envelopes causes paper jams and smears on the printout.
- ❑ Do not use envelopes with adhesive surfaces on the flaps or window envelopes.
- ❑ Avoid using envelopes that are too thin, as they may curl during printing.

### Related Information

- ➔ [“Printer Specifications” on page 121](#)



## Available Paper and Capacities

Epson recommends using genuine Epson paper to ensure high-quality printouts.

### Genuine Epson Paper

| Media Name                             | Size  | Loading Capacity (Sheets) | 2-Sided Printing | Borderless Printing <sup>*1</sup> |
|--|---|---------------------------|------------------|-----------------------------------|
| Epson Bright White Ink Jet Paper       | A4  | 80 <sup>*2</sup>          | Auto, Manual     | –                                 |
| Epson Ultra Glossy Photo Paper         | A4, 10 × 15 cm (4 × 6 in.), 13 × 18 cm (5 × 7 in.)                                | 20                        | –                | ✓                                 |
| Epson Premium Glossy Photo Paper       | A4, 10 × 15 cm (4 × 6 in.), 13 × 18 cm (5 × 7 in.), 16:9 wide size (102 × 181 mm) | 20                        | –                | ✓                                 |
| Epson Premium Semigloss Photo Paper    | A4, 10 × 15 cm (4 × 6 in.)  | 20                        | –                | ✓                                 |
| Epson Photo Paper Glossy               | A4, 10 × 15 cm (4 × 6 in.), 13 × 18 cm (5 × 7 in.)                                | 20                        | –                | ✓                                 |
| Epson Matte Paper-Heavyweight          | A4  | 20                        | –                | ✓                                 |
| Epson Double-Sided Matte Paper         | A4  | 1                         | Auto, Manual     | ✓                                 |
| Epson Photo Quality Ink Jet Paper      | A4  | 80                        | –                | –                                 |
| Epson Iron-On Cool Peel Transfer Paper | A4  | 1                         | –                | –                                 |
| Epson Photo Stickers                   | A6  | 1                         | –                | –                                 |

\*1 Borderless printing is not available for 2-sided printing.

\*2 For manual 2-sided printing, you can load up to 30 sheets for paper with one side already printed.

**Note:**

*The availability of paper varies by location. For the latest information on paper available in your area, contact Epson support.*

## Loading Paper

### Commercially Available Paper

| Media Name             | Size  | Loading Capacity (Sheets)  | 2-Sided Printing | Borderless Printing |
|------------------------|---|--|------------------|---------------------|
| Plain paper            | Letter <sup>*1</sup> , A4, B5 <sup>*1</sup> | Up to the line indicated by the triangle symbol on the edge guide. <sup>*2</sup> | Auto, Manual     | –                   |
|                        | A5 <sup>*1</sup>                            |  | Manual           |                     |
|                        | Legal <sup>*1</sup>                         | 1  | Manual           |                     |
|                        | A6 <sup>*1</sup>                            | 20   | Manual           |                     |
|                        | User Defined <sup>*1</sup>                  | 1  | Manual           |                     |
| Envelope <sup>*1</sup> | Envelope #10, Envelope DL, Envelope C6      | 10   | –                | –                   |

\*1 Only printing from computer is available.

\*2 For manual 2-sided printing, you can load up to 30 sheets for paper with one side already printed.

### Related Information

➔ [“Technical Support Web Site” on page 130](#)

## List of Paper Types

To obtain optimum printing results, select the paper type that suits the paper.

| Media Name  | Media Type       |  |
|---|------------------|--|
|   | Control Panel    | Printer Driver, Smart device <sup>*2</sup> |
| Epson Bright White Ink Jet Paper <sup>*1</sup>  | plain papers     | plain papers                               |
| Epson Ultra Glossy Photo Paper <sup>*1</sup>  | Ultra Glossy     | Epson Ultra Glossy                         |
| Epson Premium Glossy Photo Paper <sup>*1</sup>  | Prem. Glossy     | Epson Premium Glossy                       |
| Epson Premium Semigloss Photo Paper <sup>*1</sup>   | Prem. Semigloss  | Epson Premium Semigloss                    |
| Epson Photo Paper Glossy <sup>*1</sup>  | Glossy           | Photo Paper Glossy                         |
| Epson Matte Paper-Heavyweight <sup>*1</sup><br>Epson Double-Sided Matte Paper <sup>*1</sup> | Matte            | Epson Matte                                |
| Epson Photo Quality Ink Jet Paper <sup>*1</sup>   | Photo Quality IJ | Epson Photo Quality Ink Jet                |
| Epson Iron-On Cool Peel Transfer Paper  | plain papers     | plain papers                               |
| Epson Photo Stickers <sup>*1</sup>  | Photo Stickers   | Epson Photo Stickers                       |
| Plain paper <sup>*1</sup>   | plain papers     | plain papers                               |

## Loading Paper

| Media Name | Media Type    |                                |
|------------|---------------|--------------------------------|
|            | Control Panel | Printer Driver, Smart device*2 |
| Envelope   | Envelope      | Envelope                       |

\*1 These paper types are compatible with Exif Print and PRINT Image Matching when printing from the printer driver. For more details, see the documentation provided with the Exif Print or PRINT Image Matching compatible digital camera.

\*2 For smart devices, these media types can be selected when printing using Epson iPrint.

## Loading Paper in the Paper Cassette

You can load almost any type of paper. We recommend loading A4 size plain paper as this is used frequently.



**Important:**

*Do not remove or insert the paper cassette while the printer is operating. This may damage the printer.*

**Note:**

*When the output tray is ejected, check that there is no paper on the tray, and then close it by pushing it with your hand.*

1. Raise the control panel.

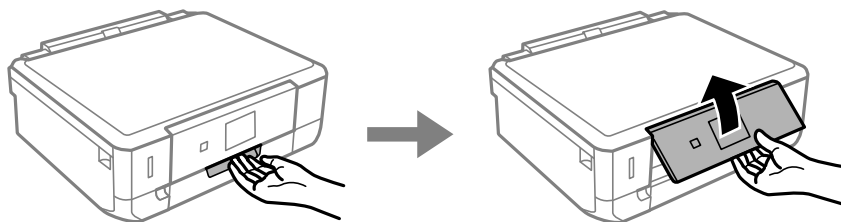

2. Open the front cover and pull out paper cassette.

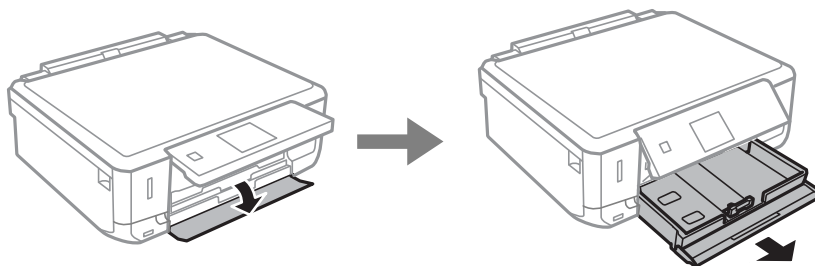

## Loading Paper

- Slide the edge guides to their maximum position.

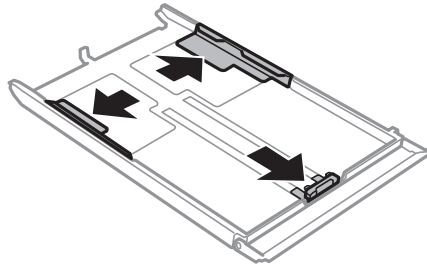

- Slide the front edge guide to the paper size you want to use.

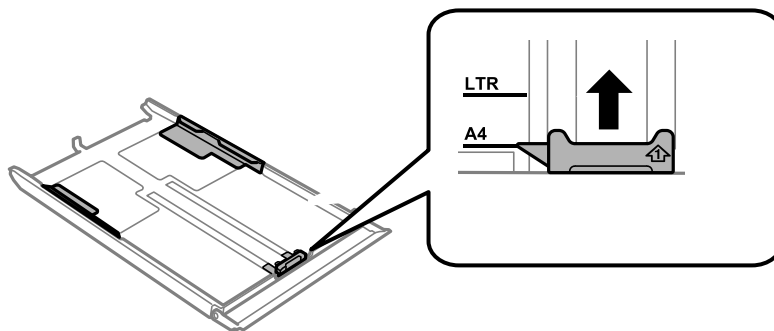

- With the printable side facing down, load paper against the front edge guide.

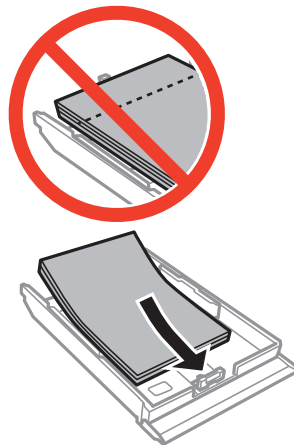

## Loading Paper

**!** *Important:*

- ❑ *Make sure the paper does not extend beyond the triangle symbol at the end of the cassette.*

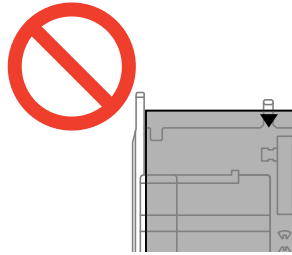

- ❑ *Do not load more than the maximum number of sheets specified for the paper. For plain paper, do not load above the line indicated by the triangle symbol on the edge guide.*

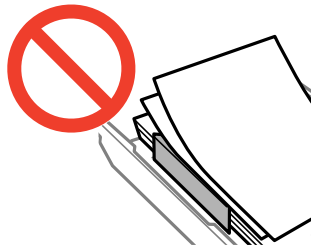

- ❑ Envelopes

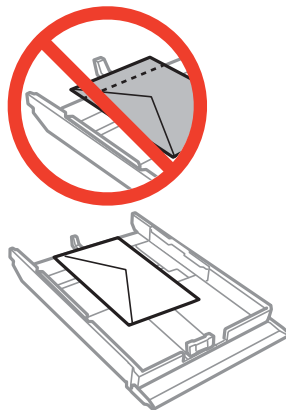

- ❑ Photo Sticker sheet

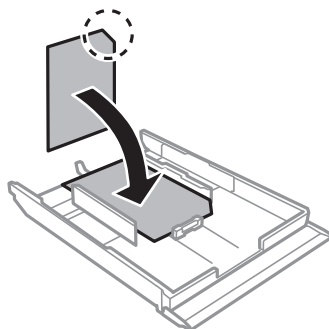

## Loading Paper

- ❑ Paper larger than A4 size:

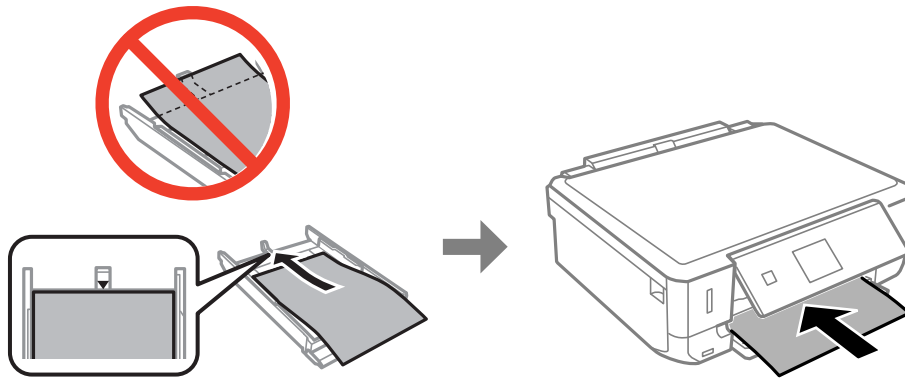

6. Slide the right edge guide to the edge of the paper.

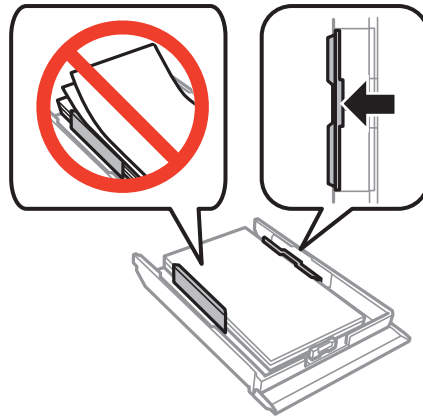

7. Insert paper cassette.

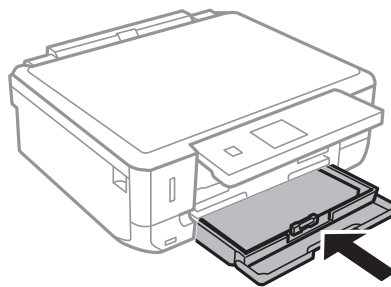

8. Check the current paper size and paper type settings displayed on the control panel. To use the settings, select **Confirm** using the ▲ or ▼ button, press the OK button, and then go to step 10. To change the settings, select **Change** using the ▲ or ▼ button, press the OK button, and then go to the next step.

**Note:**

If you have disabled the **Paper Configuration** setting, the paper setting screen is not displayed. Go to step 10.

## Loading Paper

9. On the paper size setting screen, select the paper size using the ◀ or ▶ button, and then press the OK button. On the paper type setting screen, select the paper type in the same way, and then press the OK button. Check the settings, and then press the OK button.

**Note:**

*You can also display the paper size and paper type settings screen by selecting **Setup > Printer Setup > Paper Source Setting > Paper Setup**.*

10. Slide out the output tray.

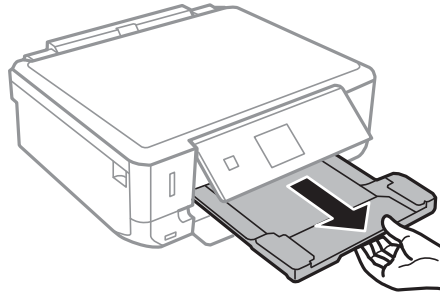

### Related Information

- ➔ [“Paper Handling Precautions” on page 24](#)
- ➔ [“Available Paper and Capacities” on page 25](#)

# Placing Originals on the Scanner Glass



**Important:**

*When placing bulky originals such as books, prevent exterior light from shining directly onto the scanner glass.*

1. Open the document cover.

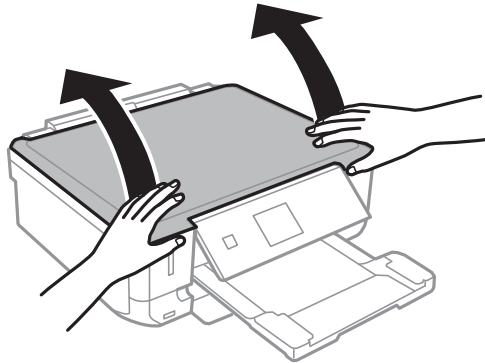

2. Remove any dust or stains on the scanner glass.
3. Place the original face-down and slide it to the corner mark.

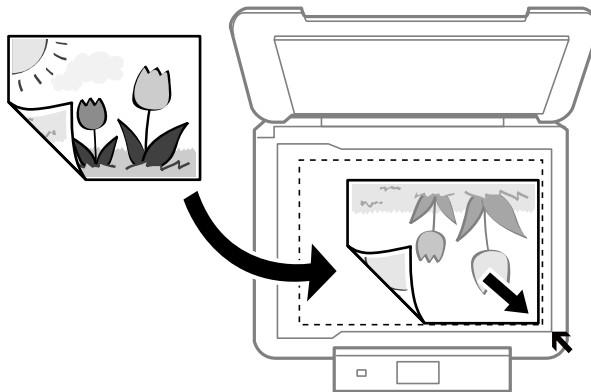

**Note:**

*A range of 1.5 mm from the edges of the scanner glass is not scanned.*

- When copying photos, place the photos 5 mm apart from the edges of the scanner glass. You can place up to two photos at the same time (depending on the size of originals). Leave 5 mm between photos.



### Placing Originals on the Scanner Glass

You can place photos of different sizes at the same time. The photos should be larger than 30 x 40mm.

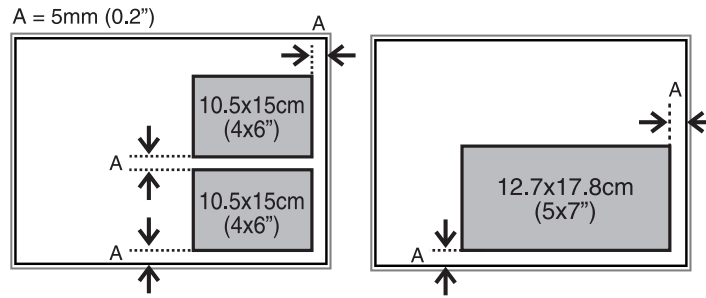

- ❑ If you are scanning using **Full Auto Mode** or thumbnail preview in EPSON Scan, place the original 4.5 mm away from the edges of the scanner glass.

Place multiple photos at least 20 mm apart from each other.

The photos should be larger than 15 x 15 mm.

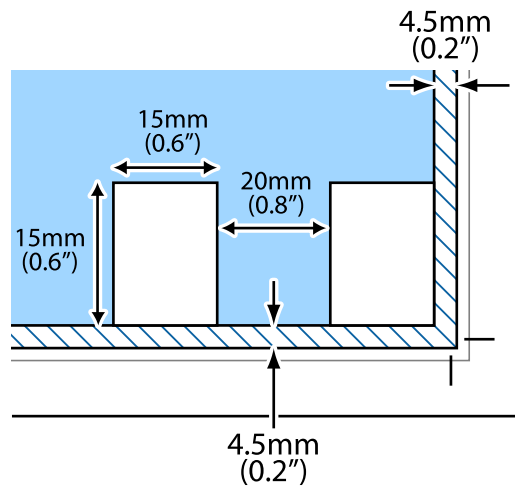

4. Close the cover gently.

**Note:**

Remove the originals after scanning or copying. If you leave the originals on the scanner glass for a long time, they may stick to the surface of the glass.

## Placing Other Originals

When copying a double-page spread

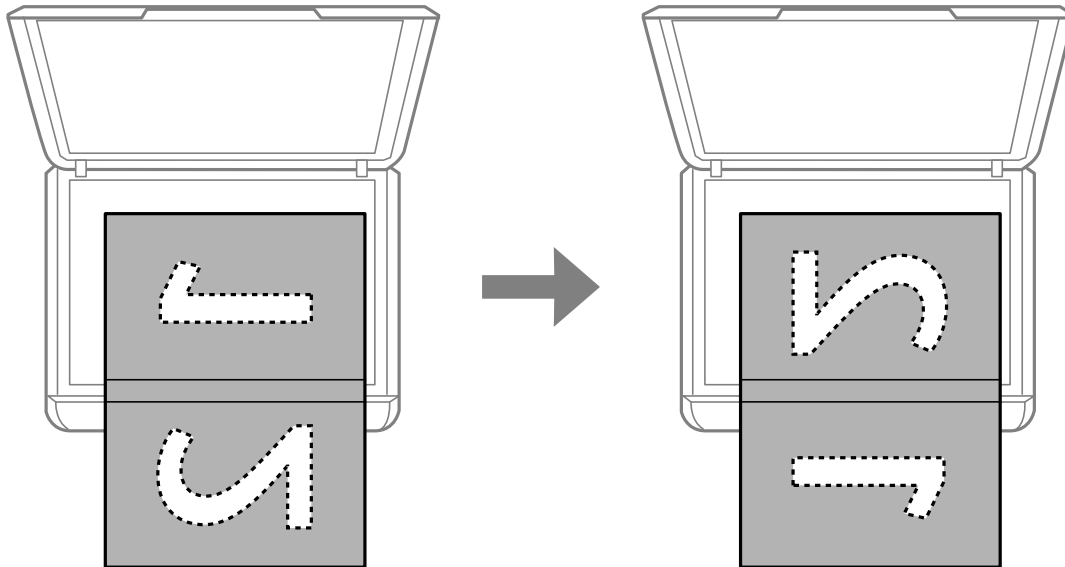

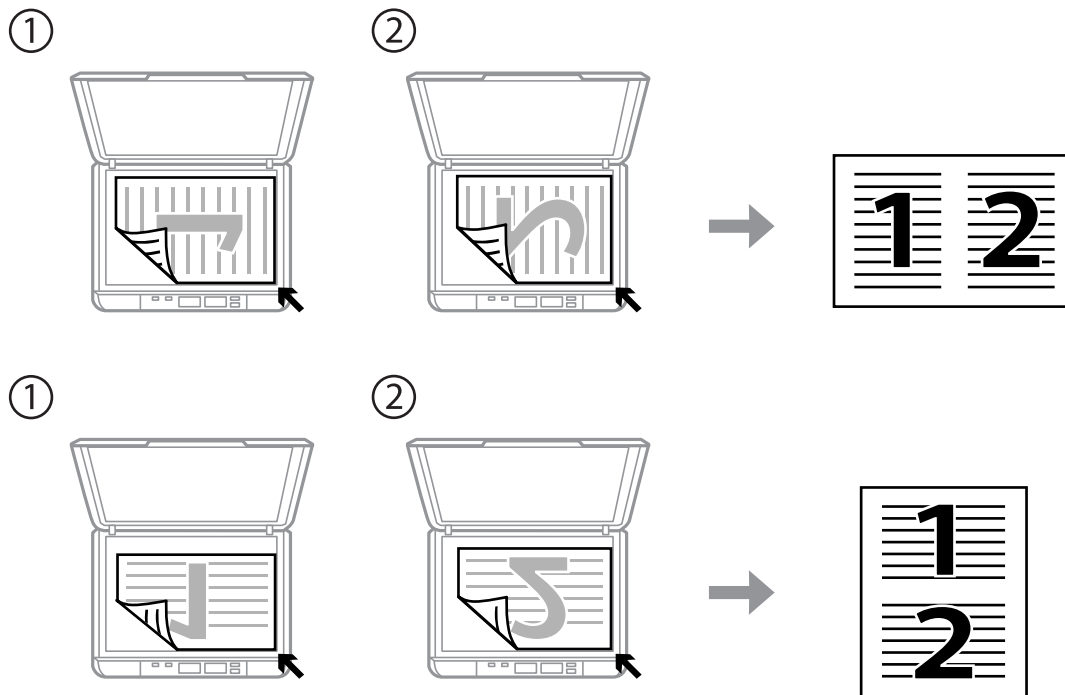

When copying into 2-up layout

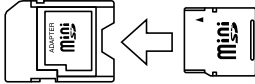

# Inserting a Memory Card

## Supported Memory Cards

|   |  |
|---|--|
|  | miniSD*<br>miniSDHC*<br>microSD*<br>microSDHC*<br>microSDXC* |
|  | SD<br>SDHC<br>SDXC   |

\* Attach an adapter to fit the memory card slot. Otherwise, the card may get stuck.

### Related Information

➔ [“Supported Memory Card Specifications” on page 123](#)

## Inserting and Removing a Memory Card

1. Insert a memory card into the printer.

The printer starts reading the data and the light flashes. When reading is complete, the light stops flashing and remains on.

### Inserting a Memory Card

**!** *Important:*

*Do not try to force the card all the way into the slot. It should not be fully inserted.*

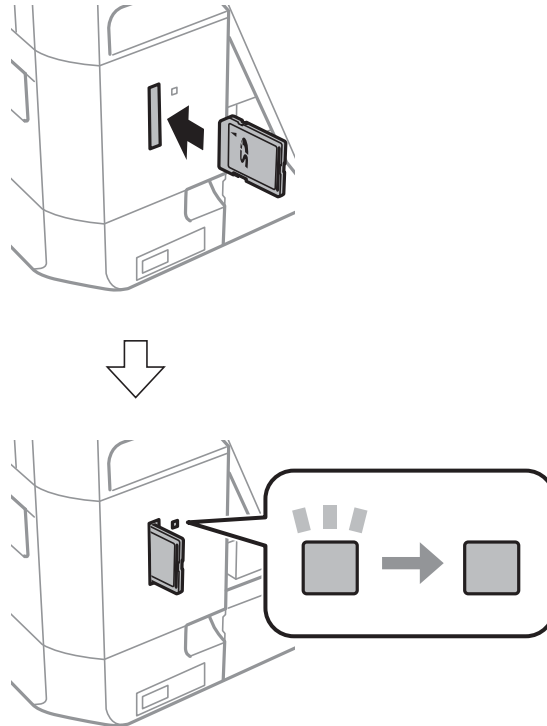

2. When you have finished using the memory card, make sure the light is not flashing, and then remove the card.

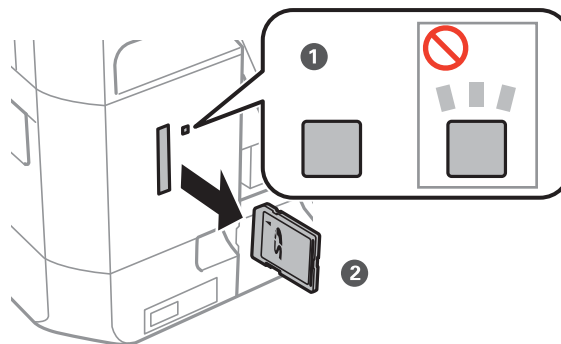

**!** *Important:*

*If you remove the memory card while the light is flashing, the data in the memory card may be lost.*

**Note:**

*If you access the memory card from a computer, you need to operate the computer to safely remove the removal device.*

#### Related Information

➔ [“Accessing a Memory Card From a Computer” on page 129](#)

# Printing

## Printing from the Control Panel

### Printing Photos by Selecting from a Memory Card

1. Load paper in the printer.



**Important:**

*Make the paper settings on the control panel.*

2. Insert a memory card into the printer.



**Important:**

*Do not remove the memory card until you have finished printing.*

**Note:**

*If you have 1000 or more photos on your memory card, photos are automatically divided into groups containing a maximum of 999 photos and the Select Group screen is displayed. Select a group containing the photos you want to print.*

3. Enter **Print Photos** from the home screen using the ◀ or ▶ button, and then press the OK button.
4. Select **Select Photos** using the ◀ or ▶ button, and then press the OK button.
5. Select a photo using the ◀ or ▶ button and set the number of copies using the ▲ or ▼ button. When printing more than one photo, repeat this procedure.
6. Press the OK button to display the print settings confirmation screen.
7. To change the print settings, press the ▼ button to display the setting screen. Use the ▲ or ▼ button to select setting items such as the paper size and the paper type, and change the settings using the ◀ or ▶ button. When you have finished, press the OK button.

**Note:**

*Press the ▶ button on the print settings confirmation screen if you want to crop a part of a photo. Use the ▲ or ▼ button to change the size of the frame, press the 🏠 button to rotate the frame, and then press the OK button. Use the ▲, ▼, ◀, or ▶ button to move the frame to the area you want to crop, and then press the OK button.*

8. Press the ⬡ button.

#### Related Information

- ➔ [“Loading Paper in the Paper Cassette” on page 27](#)
- ➔ [“List of Paper Types” on page 26](#)
- ➔ [“Inserting a Memory Card” on page 35](#)

## Printing

➔ “Print Photos Mode” on page 19

### Printing Photos from a Memory Card with Handwritten Notes

You can print a photo on a memory card with handwritten text or drawings. This allows you to create original cards such as New Year's cards or Christmas cards.

First select a photo and print a template on plain paper. Write or draw on the template and then scan it with the printer. You can then print the photo with your own personal notes and drawings.

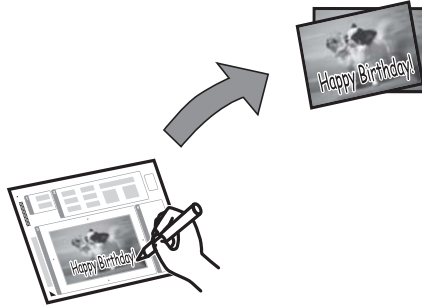

1. Insert a memory card into the printer.



**Important:**

*Do not remove the memory card until you have finished printing.*

2. Enter **Print Photos** from the home screen using the ◀ or ▶ button, and then press the OK button.
3. Select **Print Photo Greeting Card** using the ◀ or ▶ button, and then press the OK button.
4. Select **Select Photo and Print Template** using the ◀ or ▶ button, and then press the OK button.
5. Select a photo using the ◀ or ▶ button, and then press the OK button.
6. Select the **Paper Size** using the ▲ or ▼ button, and then select the size using the ◀ or ▶ button.
7. Select the **Paper Type** using the ▲ or ▼ button, select the type using the ◀ or ▶ button, and then press the OK button.
8. Select the layout using the ◀ or ▶ button, and then press the OK button.
9. Select the frame using the ◀ or ▶ button, and then press the OK button.
10. Load A4 plain paper in the printer, and then pull out the output tray to print a template.



**Important:**

*Make the paper settings on the control panel.*

11. Press the ◊ button to print a template.

## Printing

12. Follow the instructions on the template to write and draw.
13. Close the output tray by hand. Remove the A4 plain paper, load paper that matches the paper type and size indicated on the right of the template, and then pull out the output tray.

**Important:**

*Make the paper settings on the control panel.*

14. Select **Print using the Template** using the ◀ or ▶ button, and then press the OK button.
15. Place the template on the scanner glass, and then press the OK button.

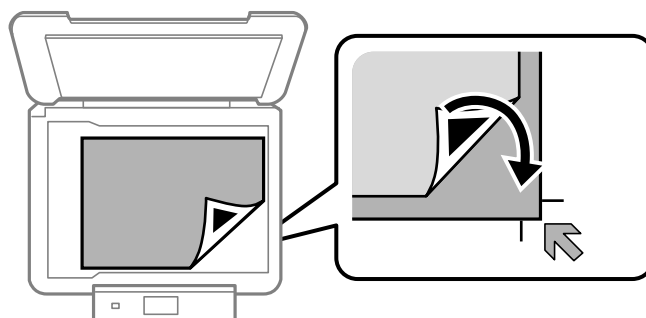
**Note:**

*Make sure that the text on the template is completely dry before placing it on the scanner glass. If there are stains on the scanner glass, the stains are also printed on the photo.*

16. Set the number of copies using the ▲ or ▼ button, and then press the ◊ button.

**Note:**

*Press the OK button to adjust the colors in the photos.*

**Related Information**

- ➔ [“Inserting a Memory Card” on page 35](#)
- ➔ [“Print Photos Mode” on page 19](#)
- ➔ [“Loading Paper in the Paper Cassette” on page 27](#)
- ➔ [“List of Paper Types” on page 26](#)
- ➔ [“Placing Originals on the Scanner Glass” on page 32](#)

## Printing

### Printing Original Writing Paper and Calendars

You can easily print lined paper, calendars, and original writing paper using the **Personal Stationery** menu.

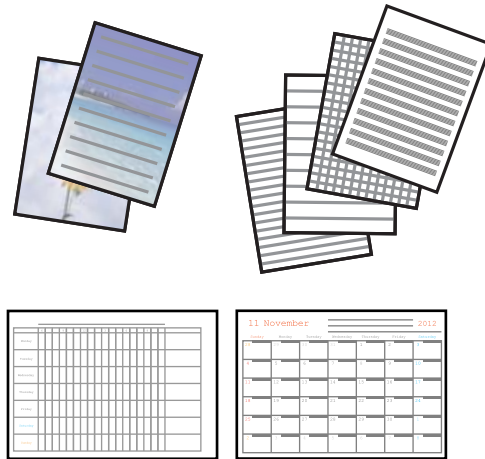

1. Load paper in the printer.



**Important:**

*Make the paper settings on the control panel.*

2. To print writing paper using a photo on your memory card, insert the memory card into the printer.
3. Enter **Personal Stationery** from the home screen using the ◀ or ▶ button, and then press the OK button.
4. Select a menu item using the ◀ or ▶ button, and then press the OK button.
5. Follow the on-screen instructions to print.

#### Related Information

- ➔ [“Loading Paper in the Paper Cassette” on page 27](#)
- ➔ [“List of Paper Types” on page 26](#)
- ➔ [“Inserting a Memory Card” on page 35](#)
- ➔ [“Personal Stationery Mode” on page 21](#)

### Printing Photos Using Other Features

This section introduces the other printing features available using the control panel.



## Printing

### Printing in Various Layouts

You can print the photos on your memory card in various layouts such as 2-up, 4-up, and upper half.



Enter **Print Photos** from the home screen using the ◀ or ▶ button, and then press the OK button. Select **Photo Layout Sheet** using the ◀ or ▶ button, and then press the OK button. Follow the on-screen instructions to print.

#### Related Information

➔ [“Print Photos Mode” on page 19](#)

### DPOF Printing

This printer is compatible with DPOF (Digital Print Order Format) Ver. 1.10. DPOF is a format that stores additional information for photos such as the date, time, user name, and printing information. DPOF-compatible cameras allow you to set which image on a memory card to print and the number of copies. When the memory card is inserted into the printer, the photos selected by the camera are printed.

#### Note:

*For information on making print settings on your camera, see the documentation provided with your camera.*

When you insert a memory card into the printer, a confirmation screen is displayed. Select **Yes** using the ▲ or ▼ button, and then press the OK button to display the print start screen. Press the ◊ button to start printing. If you want to change the print settings, press the ▼ button, and then press the OK button. Setting items are the same as in **Print Photos** mode.

#### Related Information

➔ [“Print Photos Mode” on page 19](#)

## Printing from a Computer

### Printing Basics - Windows

#### Note:

- ❑ See the online help for explanations of the setting items. Right-click an item, and then click **Help**.
- ❑ Operations differ depending on the application. See the application's help for details.

## Printing

1. Load paper in the printer.



**Important:**

*Make the paper settings on the control panel.*

2. Open the file you want to print.
3. Select **Print** or **Print Setup** from the **File** menu.
4. Select your printer.
5. Select **Preferences** or **Properties** to access the printer driver window.

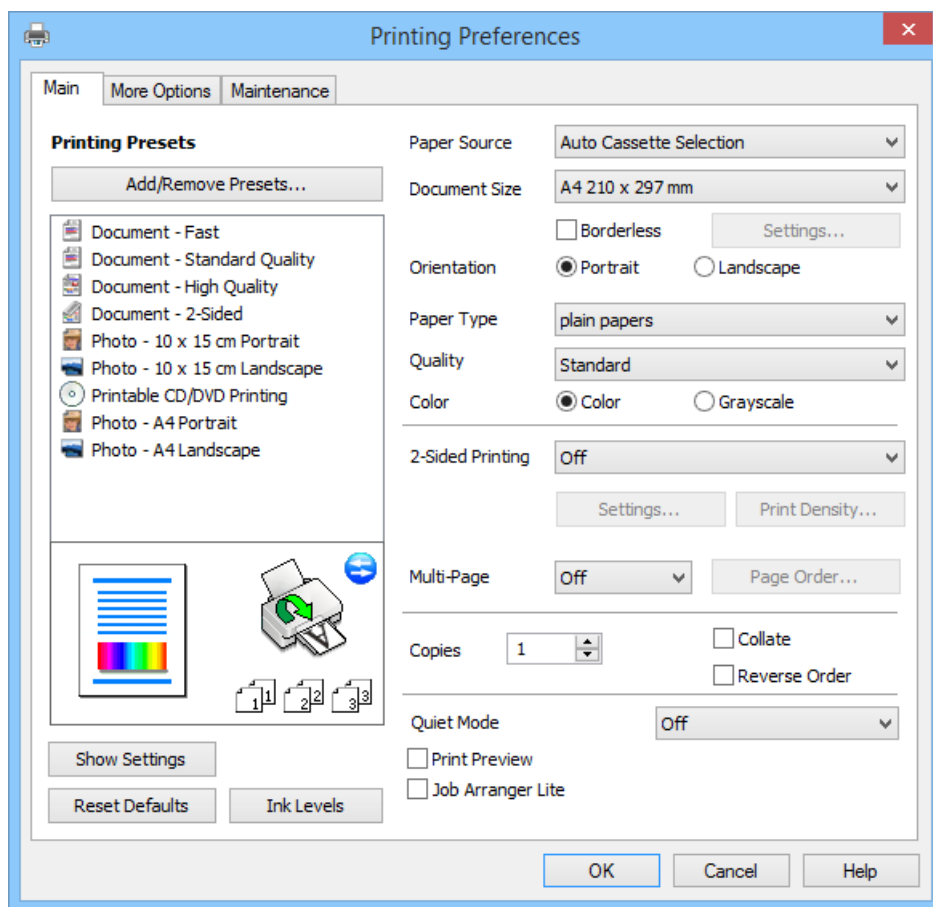

6. Make the following settings.

- Paper Source: Select the paper source in which you loaded the paper.

If the printer has only one paper source, this item is not displayed.

- Document Size: Select the paper size you loaded in the printer.

- Borderless: Select to print with no margins around the image.

In borderless printing, the print data is enlarged slightly more than the paper size so that no margins are printed around the edges of the paper. Click **Settings** to select the amount of enlargement.

- Orientation: Select the orientation you set in the application.

- Paper Type: Select the type of paper you loaded.

## Printing

- Color: Select **Grayscale** when you want to print in black or shades of gray.

**Note:**

When printing on envelopes, select **Landscape** as the **Orientation** setting.

7. Click **OK** to close the printer driver window.
8. Click **Print**.

### Related Information

- ➔ [“Available Paper and Capacities” on page 25](#)
- ➔ [“Loading Paper in the Paper Cassette” on page 27](#)
- ➔ [“Guide to Windows Printer Driver” on page 91](#)
- ➔ [“List of Paper Types” on page 26](#)

## Printing Basics - Mac OS X

**Note:**

Operations differ depending on the application. See the application's help for details.

1. Load paper in the printer.



**Important:**

Make the paper settings on the control panel.

2. Open the file you want to print.
3. Select **Print** from the **File** menu or another command to access the print dialog.

If necessary, click **Show Details** or ▼ to expand the print window.

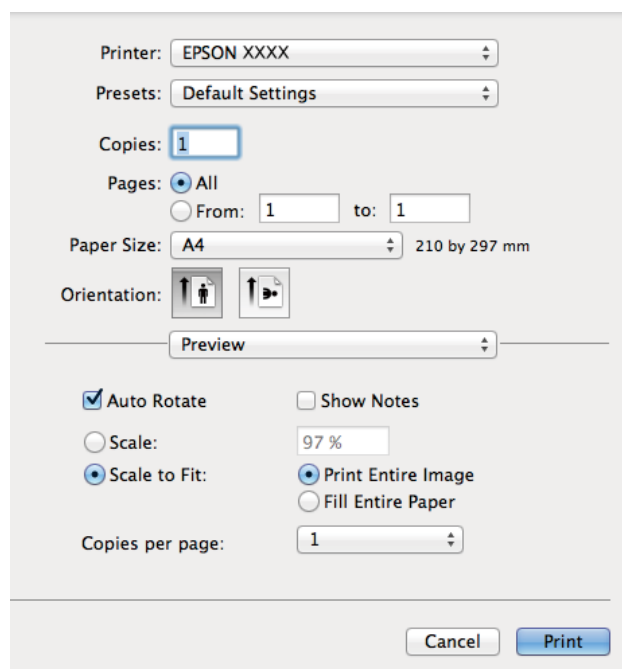

## Printing

4. Make the following settings.

- Printer: Select your printer.
- Preset: Select when you want to use the registered settings.
- Paper Size: Select the paper size you loaded in the printer.  
When printing with no margins, select a "borderless" paper size.
- Orientation: Select the orientation you set in the application.

**Note:**

When printing on envelopes, select landscape orientation.

5. Select **Print Settings** from the pop-up menu.

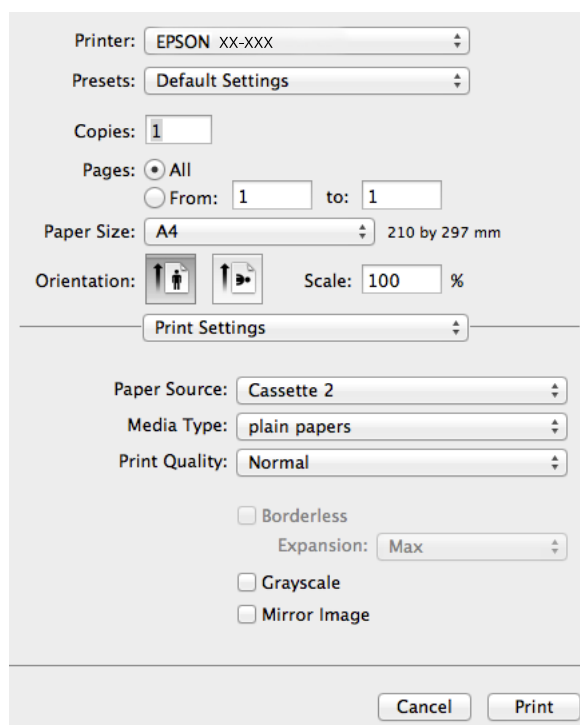

**Note:**

On Mac OS X v10.8.x or later, if the **Print Settings** menu is not displayed, the Epson printer driver has not been installed correctly.

Select **System Preferences** from the  menu > **Printers & Scanners** (or **Print & Scan**, **Print & Fax**), remove the printer, and then add the printer again. See the following to add a printer.

<http://epson.sn>

6. Make the following settings.

- Paper Source: Select the paper source in which you loaded the paper.  
If the printer has only one paper source, this item is not displayed.
- Media Type: Select the type of paper you loaded.
- Expansion: Available when selecting a borderless paper size.  
In borderless printing, the print data is enlarged slightly more than the paper size so that no margins are printed around the edges of the paper. Select the amount of enlargement.
- Grayscale: Select to print in black or shades of gray.

## Printing

- Click **Print**.

### Related Information

- ➔ “Available Paper and Capacities” on page 25
- ➔ “Loading Paper in the Paper Cassette” on page 27
- ➔ “Guide to Mac OS X Printer Driver” on page 95
- ➔ “List of Paper Types” on page 26

## Printing on 2-Sides

You can use either of the following methods to print on both sides of the paper.

- Automatic 2-sided printing
- Manual 2-sided printing (for Windows only)

When the printer has finished printing the first side, flip the paper over to print on the other side.

You can also print a booklet that can be created by folding the printout. (For Windows only)

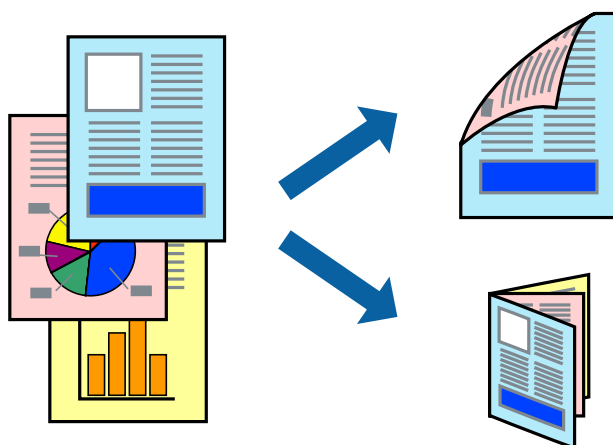

### Note:

- This feature is not available for borderless printing.
- If you do not use paper that is suitable for 2-sided printing, the print quality may decline and paper jams may occur.
- Depending on the paper and the data, ink may bleed through to the other side of the paper.

### Related Information

- ➔ “Available Paper and Capacities” on page 25

## Printing on 2-Sides (for Windows only)

### Note:

- Manual 2-sided printing is only available when **EPSON Status Monitor 3** is enabled. If **EPSON Status Monitor 3** is disabled, access the printer driver, click **Extended Settings** on the **Maintenance** tab, and then select **Enable EPSON Status Monitor 3**.
- 2-sided printing may not be available when the printer is accessed over a network or is used as a shared printer.

- Load paper in the printer.

## Printing

2. Open the file you want to print.
3. Access the printer driver window.
4. Select **Auto (Long-edge binding)**, **Auto (Short-edge binding)**, **Manual (Long-edge binding)**, or **Manual (Short-edge binding)** from **2-Sided Printing** on the **Main** tab.
5. Click **Settings**, make the appropriate settings, and then click **OK** to close the window.

**Note:**

*To print as a booklet, select **Booklet**.*

6. Click **Print Density**, set **Select Document Type**, and then click **OK** to close the window.

The printer driver automatically sets the **Print Density** options for that document type.

**Note:**

For manual 2-sided printing, the **Print Density** setting is not available.

For automatic 2-sided printing, printing may be slow depending on the combination of options selected for **Select Document Type** in the **Print Density** window, and for **Quality** on the **Main** tab.

7. Set the other items on the **Main** and **More Options** tabs as necessary, and then click **OK**.
8. Click **Print**.

For manual 2-sided printing, when the first side has finished printing, a pop-up window is displayed on the computer. Follow the on-screen instructions.

### Related Information

- ➔ [“Loading Paper in the Paper Cassette” on page 27](#)
- ➔ [“Printing Basics - Windows” on page 41](#)

## Printing on 2-Sides - Mac OS X

1. Load paper in the printer.
2. Open the file you want to print.
3. Access the printer driver window.
4. Select **Two-sided Printing Settings** from the pop-up menu, and then select the bindings in **2-sided Printing**.
5. Select **Document Type**.

**Note:**

Printing may be slow depending on the **Document Type** setting.

If you are printing high-density data such as photos or graphs, select **Text with Photo** or **Photo** as the **Document Type** setting. If scuffing occurs or the image bleeds through to the reverse side, adjust the print density and ink drying time by clicking the arrow mark next to **Adjustments**.

6. Set the other items as necessary.
7. Click **Print**.

## Printing

### Related Information

- ➔ [“Loading Paper in the Paper Cassette” on page 27](#)
- ➔ [“Printing Basics - Mac OS X” on page 43](#)

## Printing Several Pages on One Sheet

You can print two or four pages of data on a single sheet of paper.

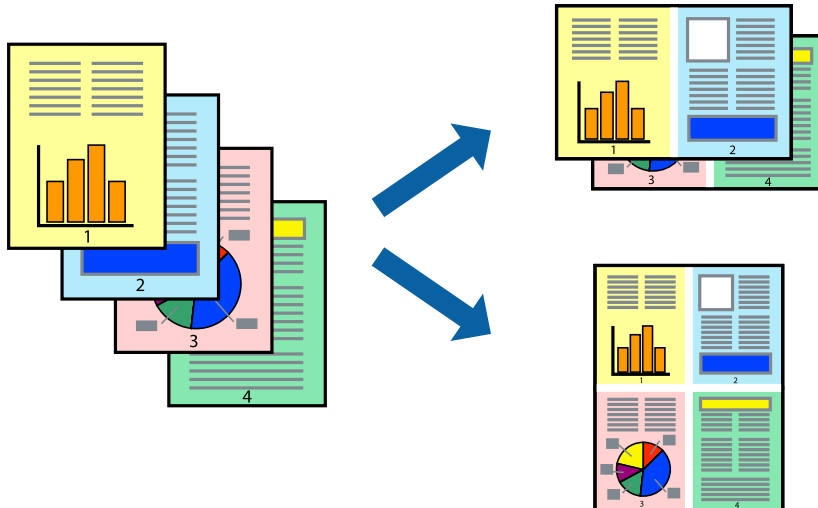

## Printing Several Pages on One Sheet - Windows

### Note:

*This feature is not available for borderless printing.*

1. Load paper in the printer.
2. Open the file you want to print.
3. Access the printer driver window.
4. Select **2-Up** or **4-Up** as the **Multi-Page** setting on the **Main** tab.
5. Click **Page Order**, make the appropriate settings, and then click **OK** to close the window.
6. Set the other items on the **Main** and **More Options** tabs as necessary, and then click **OK**.
7. Click **Print**.

### Related Information

- ➔ [“Loading Paper in the Paper Cassette” on page 27](#)
- ➔ [“Printing Basics - Windows” on page 41](#)

## Printing Several Pages on One Sheet - Mac OS X

1. Load paper in the printer.

## Printing

2. Open the file you want to print.
3. Access the print dialog.
4. Select **Layout** from the pop-up menu.
5. Set the number of pages in **Pages per Sheet**, the **Layout Direction** (page order), and **Border**.
6. Set the other items as necessary.
7. Click **Print**.

### Related Information

- ➔ [“Loading Paper in the Paper Cassette” on page 27](#)
- ➔ [“Printing Basics - Mac OS X” on page 43](#)

## Printing to Fit the Paper Size

You can print to fit the paper size you loaded in the printer.



## Printing to Fit the Paper Size - Windows

### Note:

*This feature is not available for borderless printing.*

1. Load paper in the printer.
2. Open the file you want to print.
3. Access the printer driver window.
4. Make the following settings on the **More Options** tab.
  - Document Size: Select the paper size you set in the application.
  - Output Paper: Select the paper size you loaded in the printer.

**Fit to Page** is selected automatically.

### Note:

*If you want to print a reduced image at the center of the page, select **Center**.*



## Printing

- Set the other items on the **Main** and **More Options** tabs as necessary, and then click **OK**.
- Click **Print**.

### Related Information

- ➔ [“Loading Paper in the Paper Cassette” on page 27](#)
- ➔ [“Printing Basics - Windows” on page 41](#)

## Printing to Fit the Paper Size - Mac OS X

- Load paper in the printer.
- Open the file you want to print.
- Access the print dialog.
- Select the size of the paper you set in the application as the **Paper Size** setting.
- Select **Paper Handling** from the pop-up menu.
- Select **Scale to fit paper size**.
- Select the paper size you loaded in the printer as the **Destination Paper Size** setting.
- Set the other items as necessary.
- Click **Print**.

### Related Information

- ➔ [“Loading Paper in the Paper Cassette” on page 27](#)
- ➔ [“Printing Basics - Mac OS X” on page 43](#)

## Printing Multiple Files Together (for Windows Only)

**Job Arranger Lite** allows you to combine several files created by different applications and print them as a single print job. You can specify the print settings for combined files, such as layout, print order, and orientation.

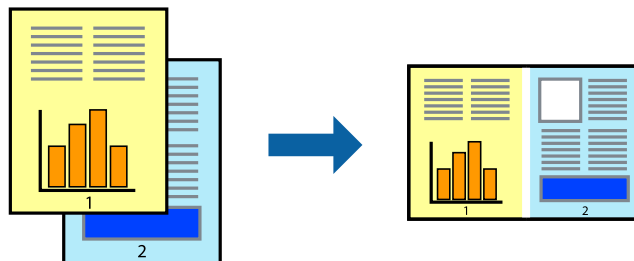

### Note:

To open a **Print Project** saved in **Job Arranger Lite**, click **Job Arranger Lite** on the printer driver's **Maintenance** tab. Next, select **Open** from the **File** menu to select the file. The extension of the saved files is ".ecl".

## Printing

1. Load paper in the printer.
2. Open the file you want to print.
3. Access the printer driver window.
4. Select **Job Arranger Lite** on the **Main** tab.
5. Click **OK** to close the printer driver window.
6. Click **Print**.

The **Job Arranger Lite** window is displayed and the print job is added to the **Print Project**.

7. With the **Job Arranger Lite** window opened, open the file that you want to combine with the current file, and then repeat steps 3 to 6.

**Note:**

*If you close the **Job Arranger Lite** window, the unsaved **Print Project** is deleted. To print later, select **Save** from the **File** menu.*

8. Select the **Layout** and **Edit** menus in **Job Arranger Lite** to edit the **Print Project** as necessary.
9. Select **Print** from the **File** menu.

### Related Information

- ➔ [“Loading Paper in the Paper Cassette” on page 27](#)
- ➔ [“Printing Basics - Windows” on page 41](#)

## Enlarged Printing and Making Posters (for Windows Only)

You can print one image on multiple sheets of paper to create a larger poster. You can print alignment marks that help you stick the sheets together.

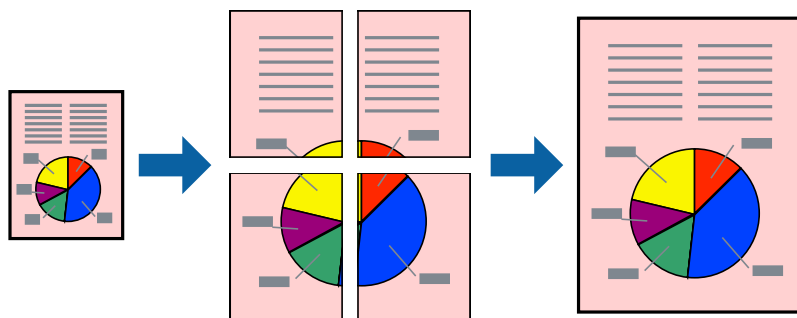

**Note:**

*This feature is not available for borderless printing.*

1. Load paper in the printer.
2. Open the file you want to print.
3. Access the printer driver window.

## Printing

4. Select **2x1 Poster**, **2x2 Poster**, **3x3 Poster**, or **4x4 Poster** from **Multi-Page** on the **Main** tab.
5. Click **Settings**, make the appropriate settings, and then click **OK**.
6. Set the other items on the **Main** and **More Options** tabs as necessary, and then click **OK**.
7. Click **Print**.

### Related Information

- ➔ [“Loading Paper in the Paper Cassette” on page 27](#)
- ➔ [“Printing Basics - Windows” on page 41](#)

## Making Posters Using Overlapping Alignment Marks

Here is an example of how to make a poster when **2x2 Poster** is selected, and **Overlapping Alignment Marks** is selected in **Print Cutting Guides**.

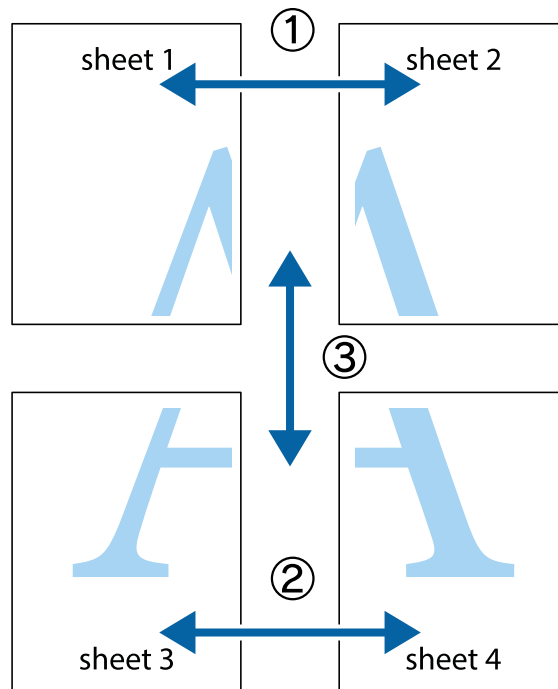

### Printing

1. Prepare Sheet 1 and Sheet 2. Cut off the margins of Sheet 1 along the vertical blue line through the center of the top and bottom cross marks.

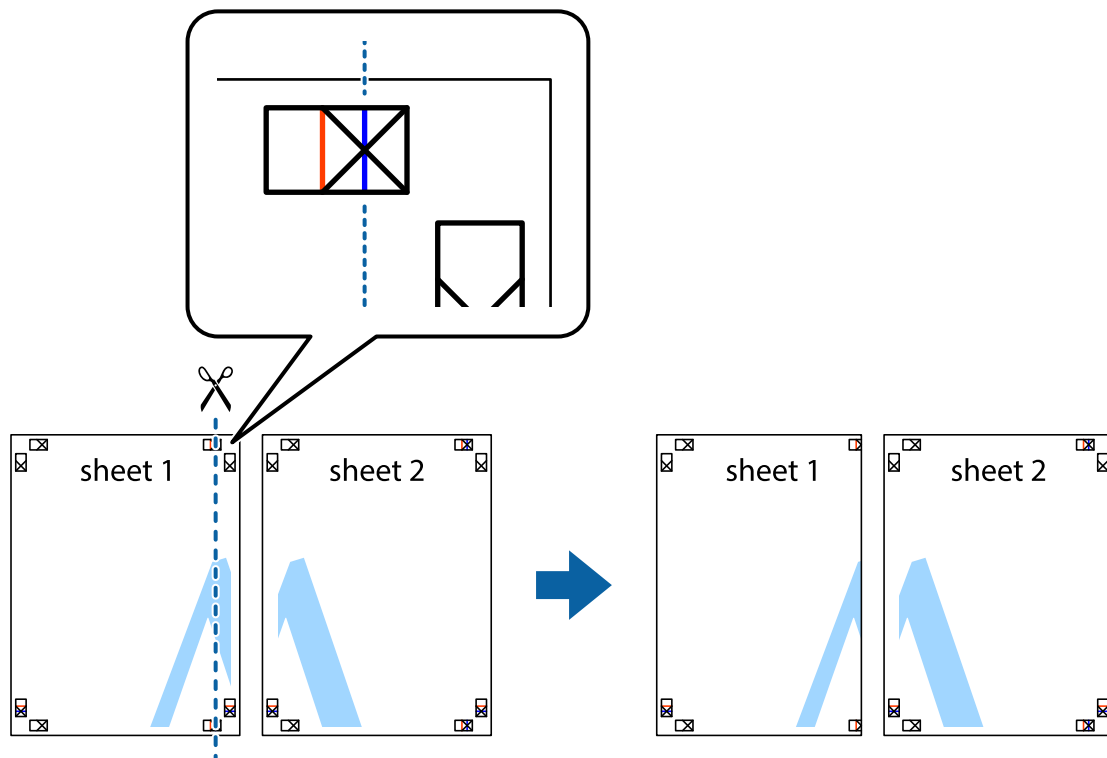

2. Place the edge of Sheet 1 on top of Sheet 2 and align the cross marks, then temporarily tape the two sheets together from the back.

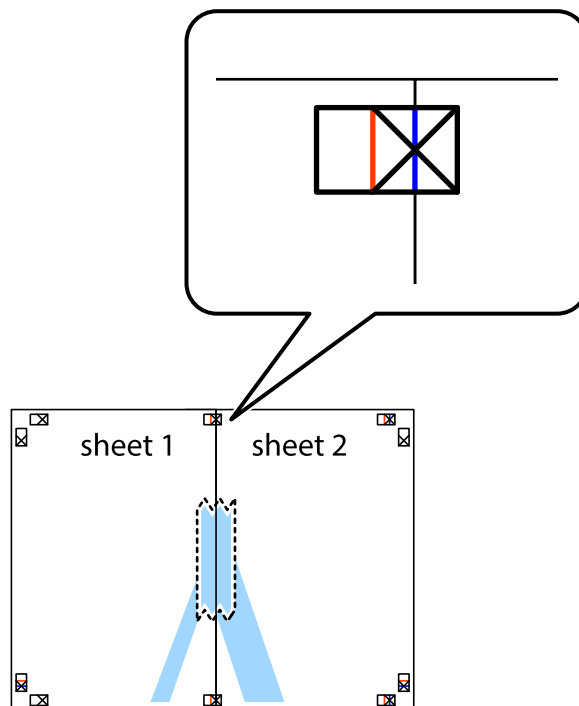

### Printing

- Cut the taped sheets in two along the vertical red line through the alignment markers (this time, the line to the left of the cross marks).

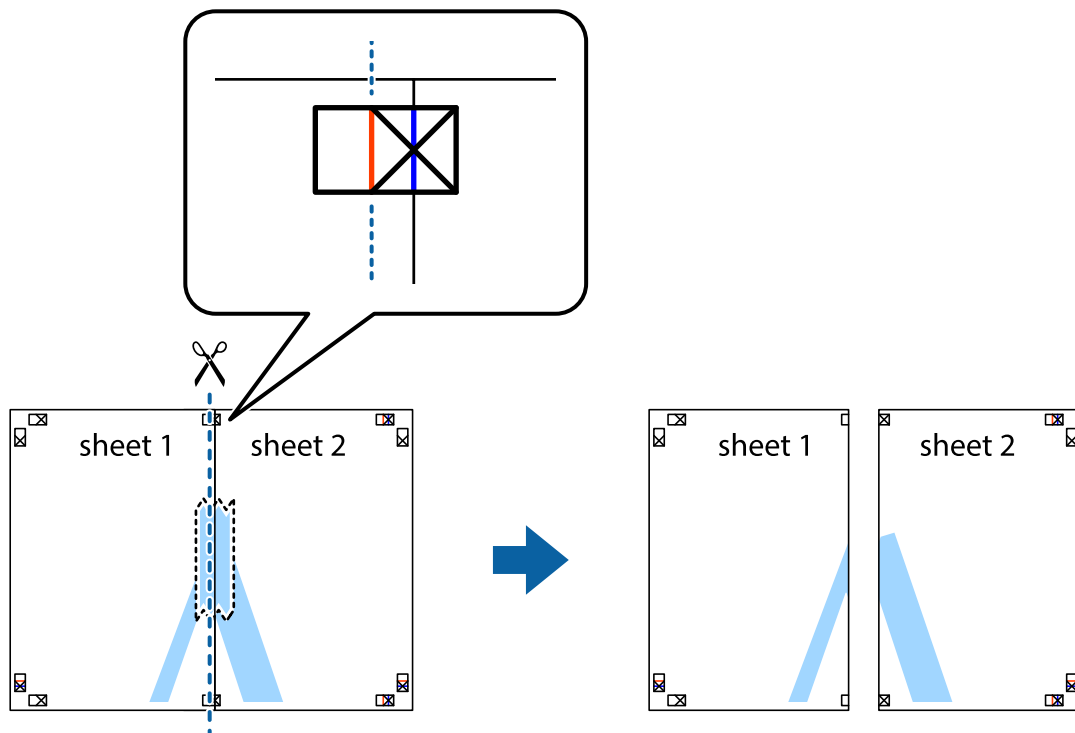

- Tape the sheets together from the back.

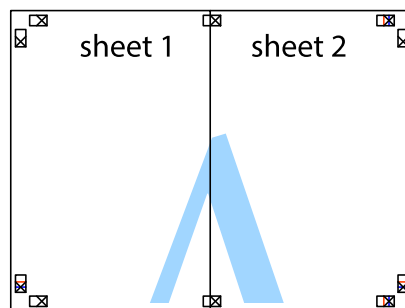

- Repeat steps 1 to 4 to tape Sheet 3 and Sheet 4 together.

### Printing

6. Cut off the margins of Sheet 1 and Sheet 2 along the horizontal blue line through the center of the left and right side cross marks.

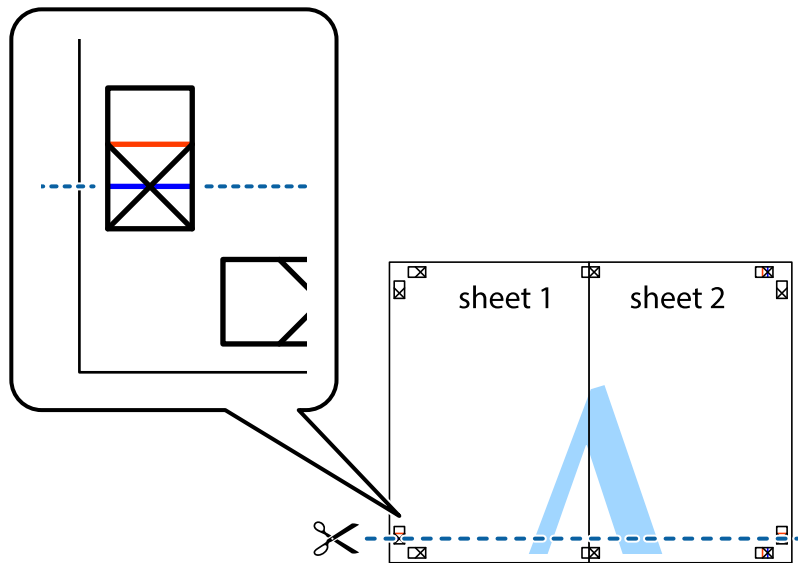

7. Place the edge of Sheet 1 and Sheet 2 on top of Sheet 3 and Sheet 4 and align the cross marks, and then temporarily tape them together from the back.

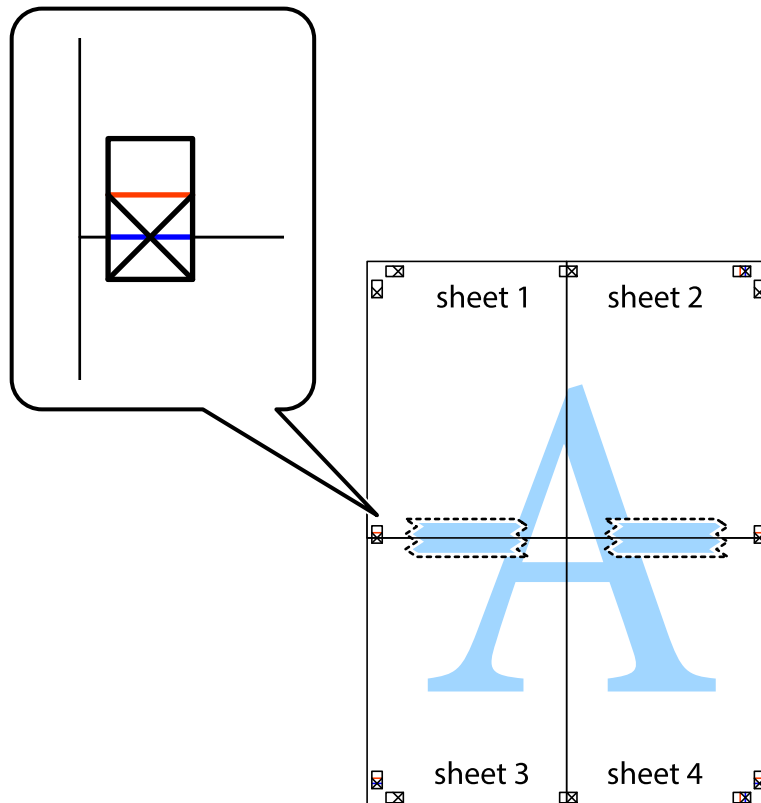

### Printing

- Cut the taped sheets in two along the horizontal red line through the alignment markers (this time, the line above the cross marks).

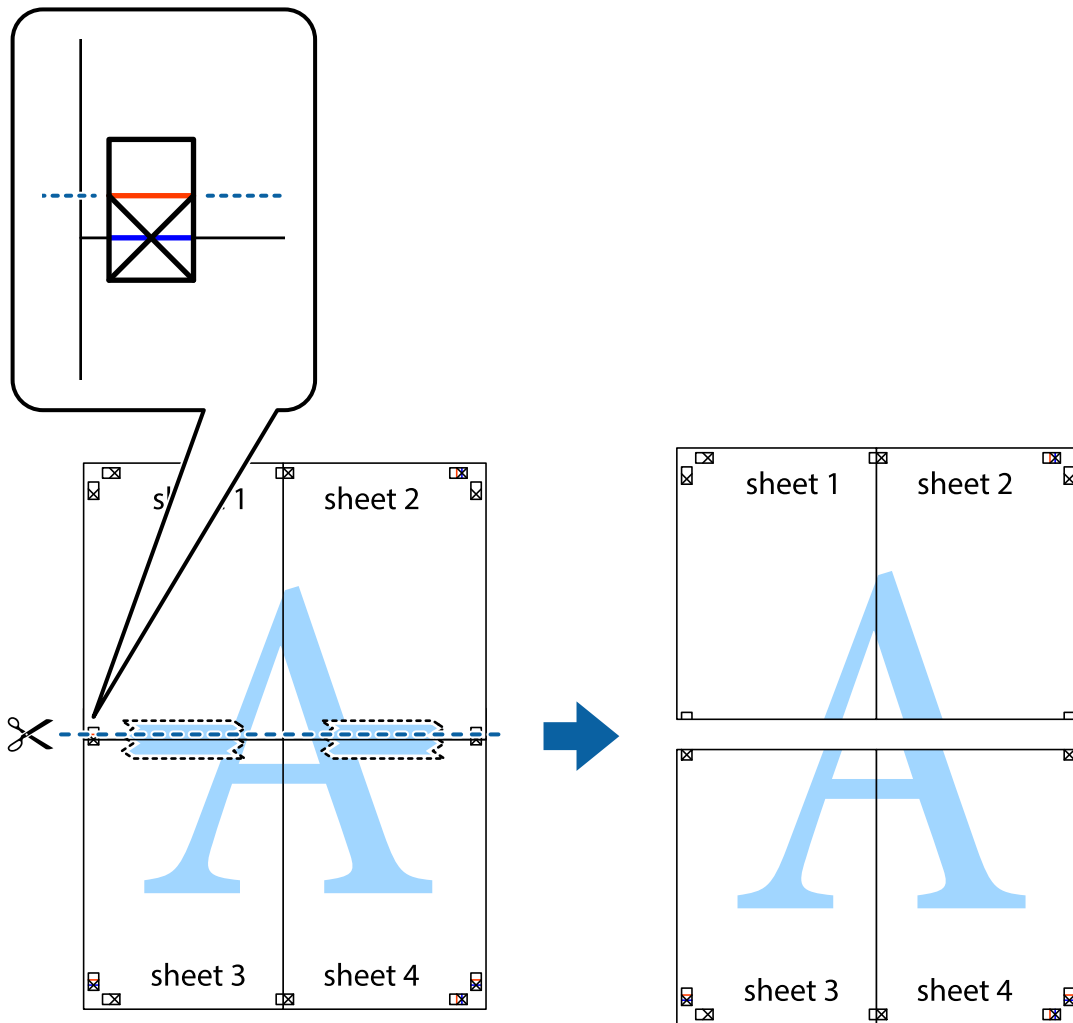

- Tape the sheets together from the back.



## Printing

10. Cut off the remaining margins along the outer guide.

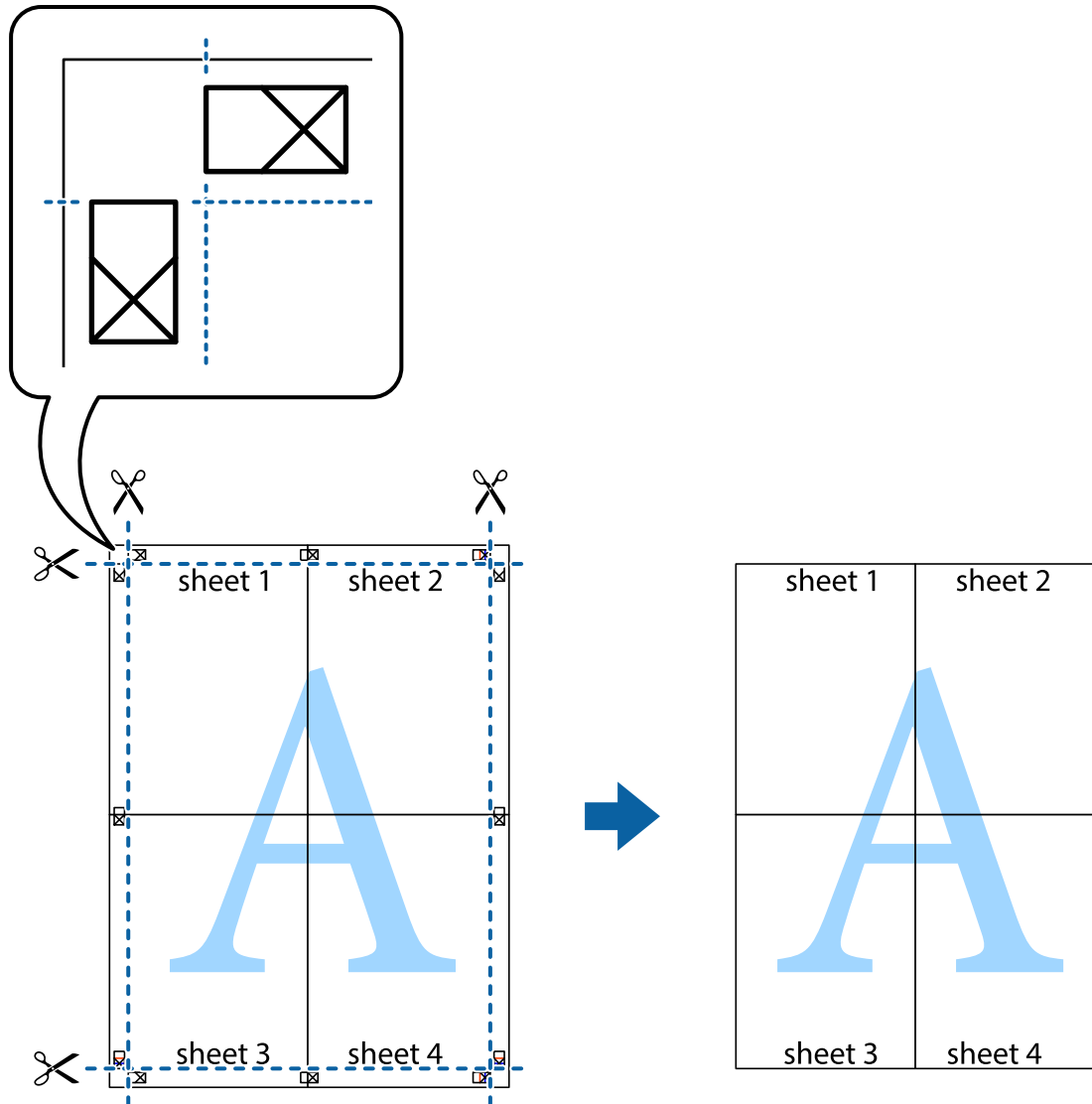

## Printing Using Advanced Features

This section introduces a variety of additional layout and printing features available on the printer driver.

### Related Information

- ➔ [“Windows Printer Driver” on page 90](#)
- ➔ [“Mac OS X Printer Driver” on page 94](#)

## Adding a Printing Preset to Print Easily

If you create your own preset of frequently used print settings on the printer driver, you can print easily by selecting the preset from the list.



## Printing

### Windows

To add your own preset, set items such as the **Document Size** and **Paper Type** on the **Main** or **More Options** tab, and then click **Add/Remove Presets** in **Printing Presets**.

**Note:**

To delete an added preset, click **Add/Remove Presets**, select the preset name you want to delete from the list, and then delete it.

### Mac OS X

Access the print dialog. To add your own preset, set items such as the **Paper Size** and **Media Type**, and then save the current settings as the preset in the **Presets** setting.

**Note:**

To delete an added preset, click **presets > Show Presets**, select the preset name you want to delete from the list, and then delete it.

## Printing a Reduced or Enlarged Document

You can reduce or enlarge the size of a document by a specific percentage.

### Windows

**Note:**

This feature is not available for borderless printing.

Set the **Document Size** on the **More Options** tab. Select **Reduce/Enlarge Document**, **Zoom to**, and then enter a percentage.

### Mac OS X

Select **Page Setup** from the **File** menu. Select the settings for **Format For** and **Paper Size**, and then enter a percentage in **Scale**. Close the window, and then print following the basic printing instructions.

## Adjusting the Print Color

You can adjust the colors used in the print job.

**PhotoEnhance** produces sharper images and more vivid colors by automatically adjusting the contrast, saturation, and brightness of the original image data.

**Note:**

- These adjustments are not applied to the original data.
- PhotoEnhance** adjusts the color by analyzing the location of the subject. Therefore, if you have changed the location of the subject by reducing, enlarging, cropping, or rotating the image, the color may change unexpectedly. Selecting the borderless setting also changes the location of the subject resulting in changes in color. If the image is out of focus, the tone may be unnatural. If the color is changed or becomes unnatural, print in a mode other than **PhotoEnhance**.

### Windows

Select the method of color correction from **Color Correction** on the **More Options** tab.

If you select **Automatic**, the colors are automatically adjusted to match the paper type and print quality settings. If you select **Custom** and click **Advanced**, you can make your own settings.

## Printing

### Mac OS X

Access the print dialog. Select **Color Matching** from the pop-up menu, and then select **EPSON Color Controls**. Select **Color Options** from the pop-up menu, and then select one of the available options. Click the arrow next to **Advanced Settings** and make the appropriate settings.

### Printing a Watermark (for Windows Only)

You can print a watermark such as "Confidential" on your printouts. You can also add your own watermark.

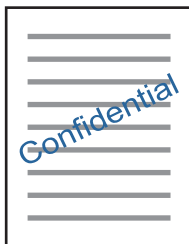

**Note:**

*This feature is not available for borderless printing.*

Click **Watermark Features** on the **More Options** tab, and then select a watermark. Click **Settings** to change details such as the color and position of the watermark.

### Printing a Header and Footer (for Windows Only)

You can print information such as a user name and printing date as headers or footers.

Click **Watermark Features** in the **More Options** tab, and then select **Header/Footer**. Click **Settings** and select necessary items from the drop-down list.

## Printing Photos Using Epson Easy Photo Print

Epson Easy Photo Print lets you lay out and print photos easily on various types of paper.

**Note:**

- By printing on genuine Epson photo paper, the ink quality is maximized and the printouts are vivid and clear.*
- To perform borderless printing using a commercially available application, make the following settings.*
  - Create image data to fit the paper size. If a margin setting is available in the application you are using, set the margin to 0 mm.*
  - Enable the borderless printing setting in the printer driver.*

### Related Information

- ➔ [“Epson Easy Photo Print” on page 98](#)
- ➔ [“Available Paper and Capacities” on page 25](#)
- ➔ [“Loading Paper in the Paper Cassette” on page 27](#)

# Printing from Smart Devices

## Using Epson iPrint

Epson iPrint is an application that allows you to print photos, documents, and Web pages from a smart device such as a smartphone or tablet. You can use local print, printing from a smart device that is connected to the same wireless network as your printer, or remote print, printing from a remote location over the Internet. To use remote print, register your printer in the Epson Connect service.



You can install Epson iPrint on your smart device from the following URL or QR code.

<http://ipr.to/a>



## Using Epson iPrint

Start Epson iPrint from your smart device and select the item you want to use from the home screen.

The following screens are subject to change without notice.

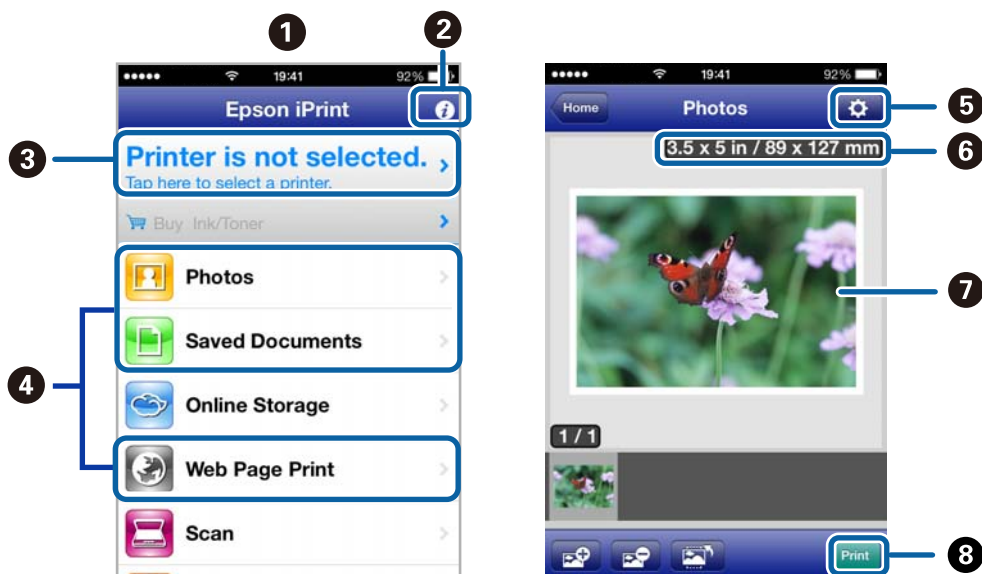

|   |  |
|---|--|
| 1 | Home screen displayed when the application is started. |
|---|--|

## Printing

|   |  |
|---|--|
| 2 | Displays information on how to setup the printer and a FAQ.  |
| 3 | Displays the screen where you can select the printer and make printer settings. Once you have selected the printer, you do not need to select it again from the next time. |
| 4 | Select what you want to print such as photos, documents, and web pages.  |
| 5 | Displays the screen to make print settings such as paper size and paper type.  |
| 6 | Displays the paper size. When this is displayed as a button, press it to display the paper settings currently set on the printer.  |
| 7 | Displays photos and documents you selected.  |
| 8 | Starts printing.   |

**Note:**

To print from the document menu using iPhone, iPad, and iPod touch running iOS, start Epson iPrint after transferring the document you want to print using the file sharing function in iTunes.

### Related Information

➔ [“Epson Connect Service” on page 89](#)

## Using AirPrint

AirPrint allows you to wirelessly print to your AirPrint-enabled printer from your iOS device using the latest version of iOS and from your Mac OS X v10.7.x or later.



**Note:**

If you disable the paper source configuration setting in the Printer Setup menu in **Setup** on the printer's control panel, you cannot use AirPrint.

See the AirPrint page on the Apple website for more details.

1. Load paper in the printer.
2. Connect your device to the same wireless network that your printer is using.
3. Print from your device to your printer.

### Related Information

➔ [“Loading Paper in the Paper Cassette” on page 27](#)

## Printing from a Digital Camera

### Note:

- ❑ You can print photos directly from a PictBridge-compatible digital camera. For more details on making operations on your camera, see the documentation provided with your camera.
- ❑ Usually digital camera settings are given priority; however, in the following situations, the printer settings are reflected.
  - ❑ When the camera's print setting is set to "use printer settings"
  - ❑ When the **Sepia** or **B&W** option is selected in the printer's print settings.
  - ❑ You may not be able to combine certain paper type, size, or layout settings depending on the camera settings and the printer settings. The digital camera settings may not be reflected in the output.
- ❑ When printing on a CD/DVD (only for printers that support CD/DVD printing), make the print settings on the printer before selecting photos on the digital camera, and then start printing. However, depending on your digital camera, you may not be able to print photos with DPOF settings on a CD/DVD.
- ❑ You can print photos with DPOF settings directly from a camera.

## Printing from a Digital Camera Connected Wirelessly

You can wirelessly print photos from digital cameras that support the DPS over IP standard (from here on referred to as PictBridge (wireless LAN)).

1. Make sure the icon that indicates that the printer is connected to a wireless network is displayed on the home screen.
2. Load paper in the printer.
3. Select **Setup** from the home screen using the ◀ or ▶ button, and then press the OK button. Select **External Device Setup** using the ◀ or ▶ button, and then press the OK button.
4. Select **Settings** or **Photo Adjustments**, press the OK button, and then change the settings if necessary. Select the setting items using the ▲ or ▼ button and change settings using the ◀ or ▶ button.
5. Connect the digital camera to the same network as the printer.
6. Display the list of available printers on the digital camera, and then select the printer you want to connect to.

### Note:

- ❑ To check the printer's name, select **Setup** > **Network Settings** > **Print Status Sheet** from the home screen, and then print the status sheet by pressing the ◊ button.
  - ❑ If your digital camera has a function that allows you to register printers, you can connect to the printer by selecting it from the next time.
7. Select the photos you want to print from the digital camera, make settings such as the number of copies, and then start printing.
  8. Disconnect the PictBridge (wireless LAN) connection to the printer from the digital camera.



### Important:

When using PictBridge (wireless LAN), you cannot use other printer functions or print from other devices. Disconnect immediately when you have finished printing.

**Related Information**

➔ [“Loading Paper in the Paper Cassette” on page 27](#)

---

## Canceling Printing

**Note:**

- ❑ *In Windows, you cannot cancel a print job from the computer once it has been completely sent to the printer. In this case, cancel the print job by using the printer's control panel.*
- ❑ *When printing several pages from Mac OS X, you cannot cancel all of the jobs by using the control panel. In this case, cancel the print job from the computer.*
- ❑ *If you have sent a print job from Mac OS X v10.6.x through the network, you may not be able to cancel printing from the computer. In this case, cancel the print job by using the printer's control panel. You need to change settings in Web Config to cancel printing from the computer. See the Network Guide for more details.*

### Canceling Printing - Printer Button

Press the  button to cancel the print job in progress.

### Canceling Printing - Windows

1. Access the printer driver window.
2. Select the **Maintenance** tab.
3. Click **Print Queue**.
4. Right-click on the job you want to cancel and then select **Cancel**.

**Related Information**

➔ [“Windows Printer Driver” on page 90](#)

### Canceling Printing - Mac OS X

1. Click the printer icon in the **Dock**.
2. Select the job you want to cancel.
3. Cancel the job.
  - ❑ Mac OS X v10.8.x to Mac OS X v10.9.x  
Click  next to the progress meter.
  - ❑ Mac OS X v10.6.x to v10.7.x  
Click **Delete**.

# Copying

---

## Copying Basics

1. Load paper in the printer.

**Important:**

*Make the paper settings on the control panel.*

2. Place the originals.
3. Enter **Copy** from the home screen using the ◀ or ▶ button, and then press the OK button.
4. Set the number of copies using the ▲ or ▼ button.
5. Select color copy or monochrome copy using the ◀ or ▶ button, and then press the OK button.
6. Select **Settings** using the ◀ or ▶ button, and then press the OK button. To change the settings, press the ▼ button, select the setting items using the ▲ or ▼ button, and then change the settings using the ◀ or ▶ button. When you have finished, press the OK button.

**Note:**

*If you want to copy by reducing or enlarging the size of a document by a specific percentage, select **Custom Size** as the **Reduce/Enlarge** setting, press the ▼ button, and then press the ◀ or ▶ button to specify a percentage. You can change the percentage in increments of 10% by holding down the ◀ or ▶ button.*

7. Press the ◊ button.

**Related Information**

- ➔ [“Loading Paper in the Paper Cassette” on page 27](#)
- ➔ [“Placing Originals on the Scanner Glass” on page 32](#)
- ➔ [“Copy Mode” on page 17](#)

---

## Copying Photos

You can copy multiple photos at the same time. You can also restore the colors in faded photos.

**Note:**

- ❑ *The smallest size of original you can copy is 30 x 40 mm.*
- ❑ *White space around the photo may not be detected.*

## Copying

1. Load paper in the printer.



**Important:**

*Make the paper settings on the control panel.*

2. Enter **Copy** from the home screen using the ◀ or ▶ button, and then press the OK button.
3. Press the OK button, select **Copy/Restore Photos** using the ◀ or ▶ button, and then press the OK button.
4. Select whether or not to restore the colors in faded photos using the ▲ or ▼ button, and then press the OK button.
5. Place the photos on the scanner glass.

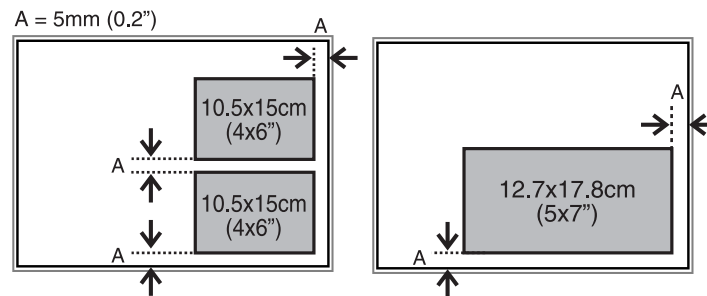

6. Press the ◊ button.

The photos are scanned and displayed on the screen.

7. Press the OK button, and then press the ▼ button on the next screen. Check the settings such as the paper size and the paper type and change the settings if necessary. Select the setting items using the ▲ or ▼ button, change the settings using the ◀ or ▶ button, and then press the OK button.

**Note:**

*If you want to print by enlarging part of a photo, select ▶. Change the frame size using the ▲ or ▼ button, and then press the OK button. Move the print area frame using the ▲, ▼, ◀, or ▶ button, and then press the OK button.*

8. Press the ◊ button.

### Related Information

- ➔ [“Loading Paper in the Paper Cassette” on page 27](#)
- ➔ [“Placing Originals on the Scanner Glass” on page 32](#)
- ➔ [“Copy Mode” on page 17](#)



# Scanning

---

## Scanning Using the Control Panel

### Scanning to a Memory Card

You can save the scanned image to a memory card.

1. Place the originals.
2. Insert a memory card into the printer.
3. Enter **Scan** from the home screen using the ◀ or ▶ button, and then press the OK button.
4. Select **To Memory** using the ◀ or ▶ button and press the OK button.
5. Check settings such as the save format. To change the settings, press the ▼ button to display the setting screen. Select the setting item using the ▲ or ▼ button, and then change the setting using the ◀ or ▶ button. When you have finished, press the OK button.
6. Press the ⬡ button.

#### Related Information

- ➔ [“Inserting a Memory Card” on page 35](#)
- ➔ [“Placing Originals on the Scanner Glass” on page 32](#)
- ➔ [“Scan Mode” on page 20](#)

### Scanning to a Computer

You can save the scanned image to a computer.

**Important:**

*Make sure you have installed EPSON Scan and Epson Event Manager on your computer before using this feature.*

1. Place the originals.
2. Enter **Scan** from the home screen using the ◀ or ▶ button, and then press the OK button.
3. Select **To Computer (JPEG)**, **To Computer (PDF)**, or **To Computer (Email)** using the ◀ or ▶ button, and then press the OK button.

## Scanning

- Select the computer to which you want to save the scanned images.

**Note:**

- ❑ You can change to frequently-used scan settings such as the document type, folder to save, or save format by using Epson Event Manager.
- ❑ When the printer is connected to a network, you can select the computer to which you want to save the scanned image. Up to 20 computers can be displayed on the printer's control panel.
- ❑ When the computer to which you want to save the scanned images is detected on the network, the initial 15 characters of the computer name are displayed on the control panel. If you set **Network Scan Name (Alphanumeric)** in Epson Event Manager, it is displayed on the control panel.

- Press the  button.





### Related Information

- ➔ [“Placing Originals on the Scanner Glass” on page 32](#)
- ➔ [“Epson Event Manager” on page 97](#)

## Scanning to a Computer (WSD)

**Note:**

- ❑ Before using this feature, you need to setup your computer. See the Network Guide for more details.
- ❑ This feature is only available for computers running Windows 8.1/Windows 8/Windows 7/Windows Vista.

- Place the originals.
- Enter **Scan** from the home screen using the  or  button, and then press the OK button.
- Select **To Computer (WSD)** using the  or  button, and then press the OK button.
- Select a computer.
- Press the  button.

**Note:**

See your computer's documentation for information on where the scanned image is stored on the computer.

### Related Information

- ➔ [“Placing Originals on the Scanner Glass” on page 32](#)
- ➔ [“Scan Mode” on page 20](#)

---

## Scanning from a Computer

Scan using the scanner driver "EPSON Scan". See the EPSON Scan help for an explanation of each setting item.

## Scanning Basics

This section uses EPSON Scan's **Home Mode** to explain the basics of scanning. The operation work flow is the same in other scanning modes.

## Scanning

1. Place the originals.
2. Start EPSON Scan.
3. Select **Home Mode** from the **Mode** list.

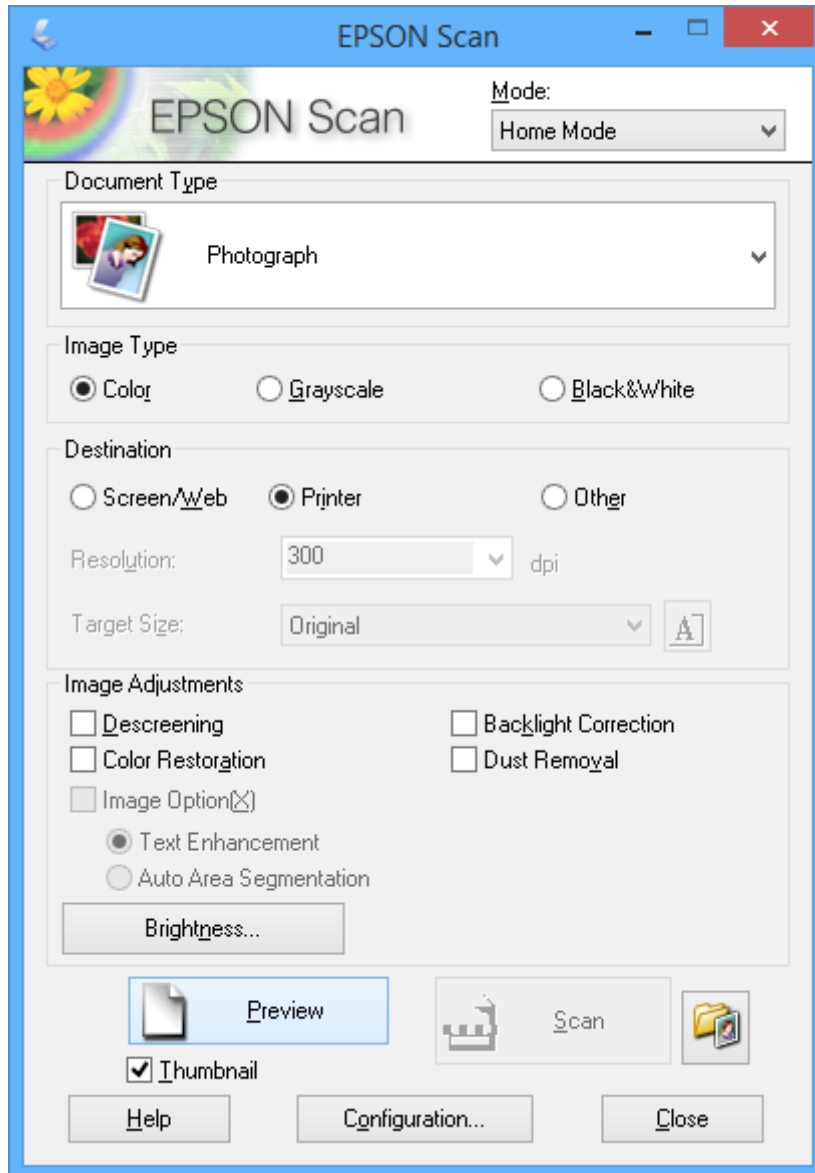

4. Make the following settings.
  - Document Type: Select the type of the original you want to scan.
  - Image Type: Select the color type of the image you want to scan.  
Although this is automatically selected by the **Document Type** setting, you can change the setting.
  - Destination: Select the resolution of the image you want to scan.  
If you select **Other**, you can set **Resolution**.
  - Thumbnail: Only available if you select **Photograph** as the Document Type setting.  
If you select this item and click **Preview**, you can scan by automatically detecting the scan area, direction, or skew of the document, or place multiple photos on the scanner glass.

## Scanning

5. Click **Preview**.

**Note:**

- ❑ *Depending on the photos and the scanning conditions, the scan results may not be as intended. Clear **Thumbnail**, and only place one photo.*
- ❑ *When placing multiple photos, place them at least 20 mm (0.8 inch) apart. Also, the edge area of the scanner glass is not scanned.*

6. Adjust the quality or brightness of the image as necessary.

**Note:**

*Depending on the originals, the scan results may not be as intended.*

7. Click **Scan**.

8. In the **File Save Settings** window, make appropriate settings and then click **OK**.

**Note:**

*When **Show this dialog box before next scan** is cleared, the **File Save Settings** screen is not displayed and scanning starts immediately. To display the **File Save Settings** screen, click the icon (**File Save Settings**) to the right of **Scan** before starting to scan.*

### Related Information

- ➔ [“Placing Originals on the Scanner Glass” on page 32](#)
- ➔ [“EPSON Scan \(Scanner Driver\)” on page 97](#)

## Scanning

## Scanning Using Advanced Features

## Scanning by Detecting the Original Automatically (Full Auto Mode)

You can start scanning by simply placing the original and clicking **Scan**. Select **Full Auto Mode** from the **Mode** list in EPSON Scan.

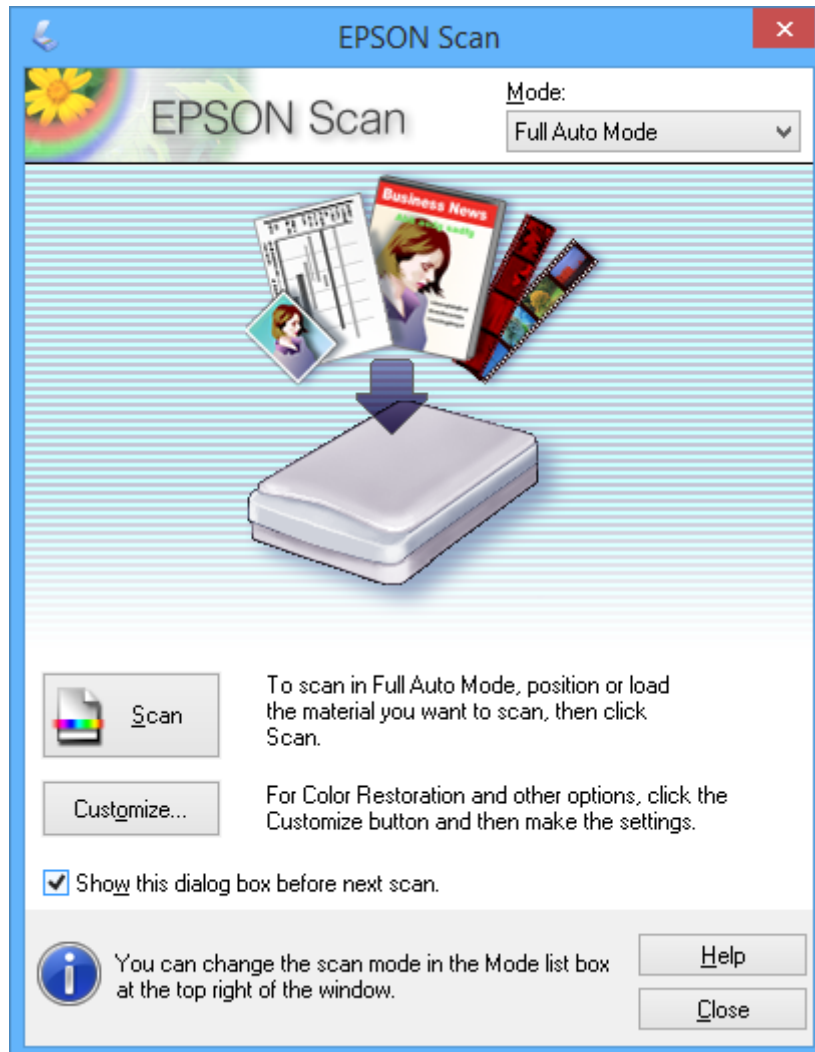

## Scanning

### Scanning at a Specified Size (Office Mode)

You can scan the originals at a specified size without previewing. Select **Office Mode** from the **Mode** list in EPSON Scan.

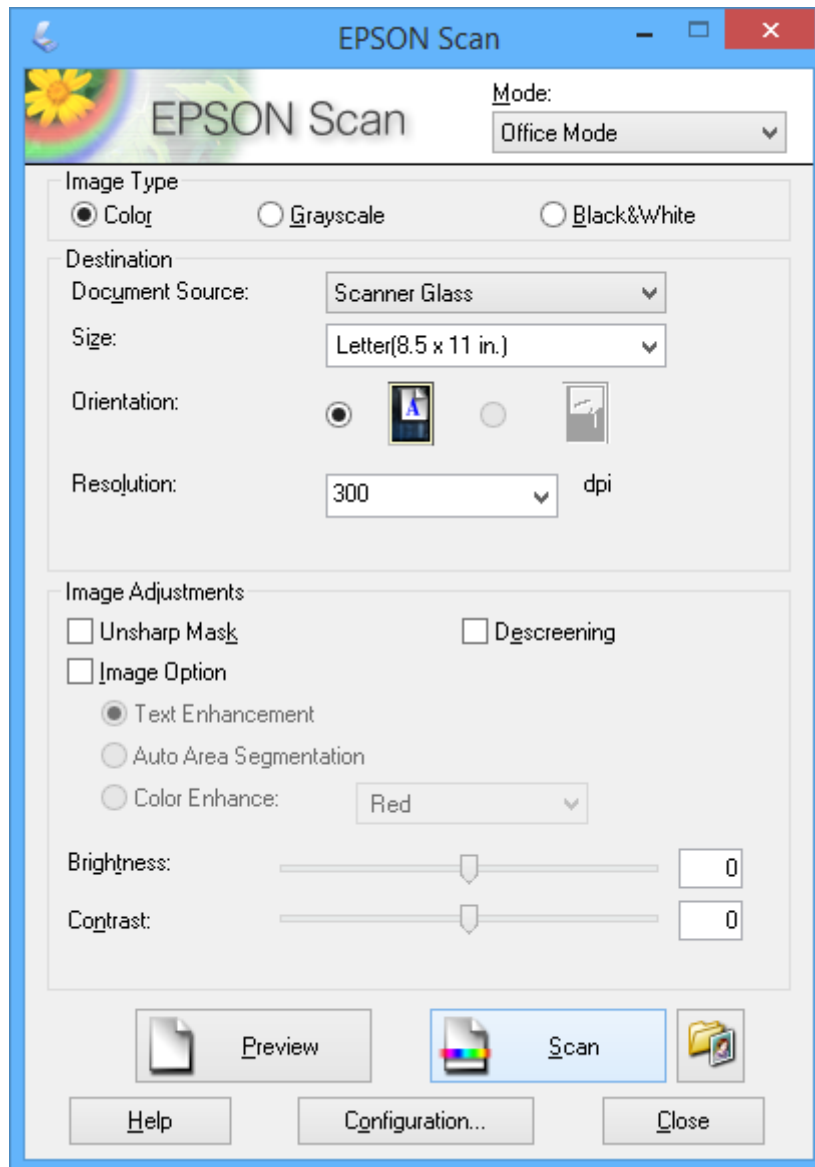

## Scanning

**Scanning by Adjusting the Image Quality (Professional Mode)**

You can scan images while adjusting the quality and color. This mode is recommended for advanced users. Select **Professional Mode** from the **Mode** list in EPSON Scan.

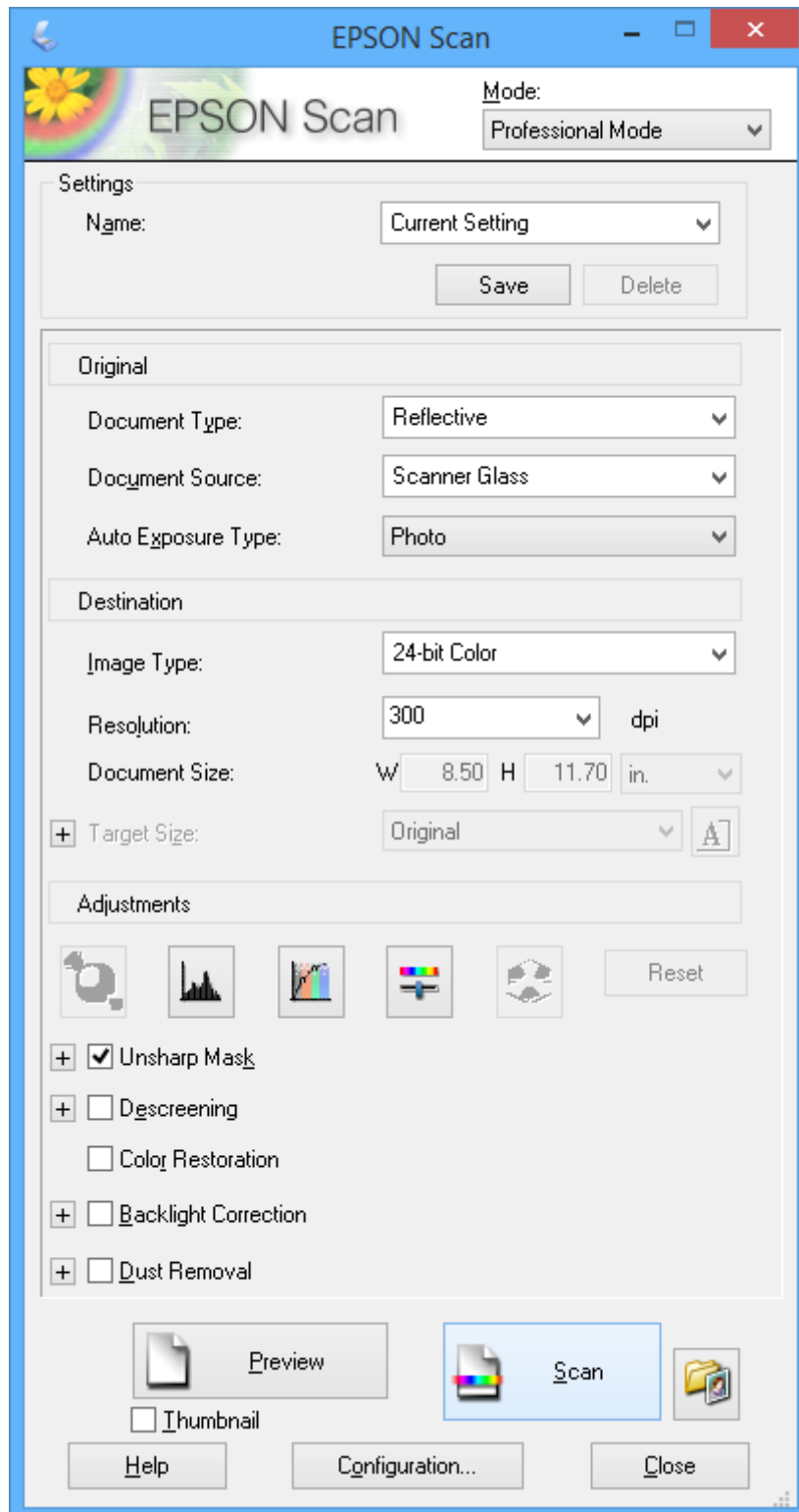

# Scanning from Smart Devices

Epson iPrint is an application that allows you to scan photos and documents from a smart device, such as a smartphone or tablet, that is connected to the same wireless network as your printer. You can save the scanned data on a smart device or to Cloud services, send it by email, or print it.

You can install Epson iPrint on your smart device from the following URL or QR code.

<http://ipr.to/a>



## Using Epson iPrint

Start Epson iPrint from your smart device and select the item you want to use from the home screen.

The following screens are subject to change without notice.

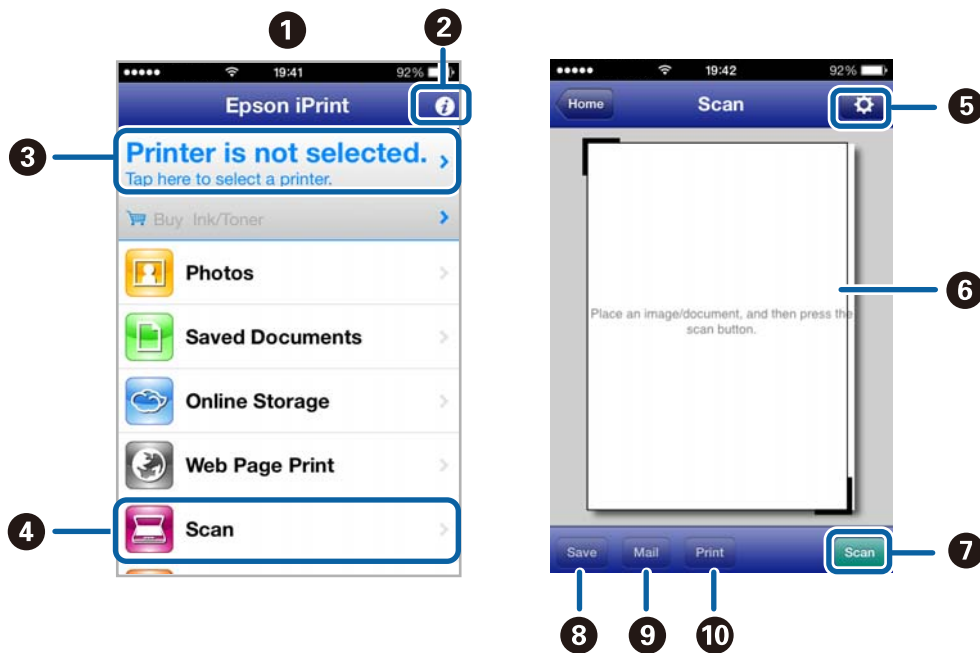

|   |  |
|---|--|
| 1 | Home screen displayed when the application is started.   |
| 2 | Displays information on how to setup the printer and a FAQ.  |
| 3 | Displays the screen where you can select the printer and make printer settings. Once you have selected the printer, you do not need to select it again from the next time. |
| 4 | Displays the scanning screen.  |
| 5 | Displays the screen where you can make scan settings such as resolution.   |
| 6 | Displays scanned images.   |
| 7 | Starts scanning.   |



## Scanning

|    |  |
|----|--|
| 8  | Displays the screen where you can save scanned data to a smart device or Cloud services. |
| 9  | Displays the screen where you can send scanned data by email.                            |
| 10 | Displays the screen where you can print scanned data.                                    |

### Related Information

- ➔ [“Using Epson iPrint” on page 59](#)
- ➔ [“Epson Connect Service” on page 89](#)

# Replacing Ink Cartridges

---

## Checking the Ink Levels

You can check the approximate ink levels from the control panel or the computer.

### Checking the Ink Levels - Control Panel

1. Enter **Setup** from the home screen using the ◀ or ▶ button, and then press the OK button.
2. Select **Ink Levels** using the ◀ or ▶ button, and then press the OK button.

### Checking the Ink Levels - Windows

1. Access the printer driver window.
2. Click **EPSON Status Monitor 3** on the **Maintenance** tab.

**Note:**

*If EPSON Status Monitor 3 is disabled, click **Extended Settings** on the **Maintenance** tab, and then select **Enable EPSON Status Monitor 3**.*

#### Related Information

➔ [“Windows Printer Driver” on page 90](#)

### Checking the Ink Levels - Mac OS X

1. Select **System Preferences** from the  menu > **Printers & Scanners** (or **Print & Scan**, **Print & Fax**), and then select the printer.
2. Click **Options & Supplies** > **Utility** > **Open Printer Utility**.
3. Click **EPSON Status Monitor**.

---

## Ink Cartridge Codes

Epson recommends the use of genuine Epson ink cartridges. Epson cannot guarantee the quality or reliability of non-genuine ink. The use of non-genuine ink may cause damage that is not covered by Epson's warranties, and under certain circumstances, may cause erratic printer behavior. Information about non-genuine ink levels may not be displayed.

The following are the codes for genuine Epson ink cartridges.

## Replacing Ink Cartridges

| Product  | Icon  | BK (Black)     | PBK (Photo Black) | C (Cyan)       | M (Magenta)    | Y (Yellow)     |
|----------|---|----------------|-------------------|----------------|----------------|----------------|
| XP-520   | Polar Bear<br> | 26<br>26XL*1   | 26<br>26XL*1      | 26<br>26XL*1   | 26<br>26XL*1   | 26<br>26XL*1   |
| XP-520*2 | –   | 273<br>273XL*1 | 273<br>273XL*1    | 273<br>273XL*1 | 273<br>273XL*1 | 273<br>273XL*1 |

\*1 "XL" indicates a large cartridge.

\*2 For Australia and New Zealand.

### Note:

- Not all cartridges are available in all regions.
- For information on Epson's ink cartridge yields, visit the following website.  
<http://www.epson.eu/pageyield>

## Ink Cartridge Handling Precautions

Read the following instructions before replacing ink cartridges.

### Handling precautions

- Store ink cartridges at normal room temperature and keep them away from direct sunlight.
- Epson recommends using the ink cartridge before the date printed on the package.
- For best results, use up ink cartridge within six months of opening the package.
- For best results, store ink cartridge packages with their bottom down.
- After bringing an ink cartridge inside from a cold storage site, allow it to warm up at room temperature for at least three hours before using it.
- Do not open the ink cartridge package until you are ready to install it in the printer. The cartridge is vacuum packed to maintain its reliability. If you leave a cartridge unpacked for a long time before using it, normal printing may not be possible.
- Do not touch the sections shown in the illustration. Doing so may prevent normal operation and printing.

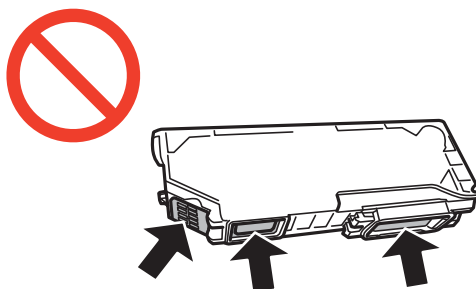

- Install all ink cartridges; otherwise you cannot print.

## Replacing Ink Cartridges

- ❑ Do not replace ink cartridges with the power off. Do not move the print head by hand; otherwise, you may damage the printer.
- ❑ After installing the ink cartridge, the power light continues to flash while the printer is charging ink. Do not turn off the printer during ink charging. If the ink charging is incomplete, you may not be able to print.
- ❑ Do not leave the printer with the ink cartridges removed or do not turn off the printer during cartridge replacement. Otherwise, ink remaining in the print head nozzles will dry out and you may not be able to print.
- ❑ Be careful not to let dust or any objects get inside the ink cartridge holder. Anything inside the holder may adversely affect the printing results or result in an inability to print. If anything gets inside the holder, remove it carefully.
- ❑ If you remove the cartridge from the printer for later use or to dispose of it, make sure you put the cap back on the cartridge's ink supply port to prevent ink from drying out or to prevent surrounding areas from getting smeared by ink.

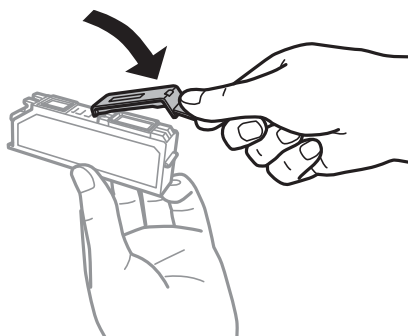

- ❑ This printer uses ink cartridges equipped with a green chip that monitors information such as the amount of remaining ink for each cartridge. This means that even if the cartridge is removed from the printer before it is expended, you can still use the cartridge after reinserting it back into the printer. However, when reinserting a cartridge, some ink may be consumed to guarantee printer performance.
- ❑ For maximum ink efficiency, only remove an ink cartridge when you are ready to replace it. Ink cartridges with low ink status may not be used when reinserted.
- ❑ To ensure you receive premium print quality and to help protect your print head, a variable ink safety reserve remains in the cartridge when your printer indicates to replace the cartridge. The yields quoted for you do not include this reserve.
- ❑ Although the ink cartridges may contain recycled materials, this does not affect printer function or performance.
- ❑ Specifications and appearance of the ink cartridge are subject to change without prior notice for improvement.
- ❑ Do not disassemble or remodel the ink cartridge, otherwise you may not be able to print normally.
- ❑ You cannot use the cartridges that came with the printer for the replacement.
- ❑ Quoted yields may vary depending on the images that you are printing, the paper type that you are using, the frequency of your prints and environmental conditions such as temperature.
- ❑ Finish ink cartridge replacement promptly. Do not leave the printer with the ink cartridges removed.

### Ink Consumption

- ❑ To maintain optimum print head performance, some ink is consumed from all cartridges not only during printing but also during maintenance operations such as ink cartridge replacement and print head cleaning.
- ❑ When printing in monochrome or grayscale, color inks instead of black ink may be used depending on the paper type or print quality settings. This is because a mixture of color inks is used to create black.

## Replacing Ink Cartridges

- ❑ The ink in the ink cartridges supplied with your printer is partly used during initial setup. In order to produce high quality printouts, the print head in your printer will be fully charged with ink. This one-off process consumes a quantity of ink and therefore these cartridges may print fewer pages compared to subsequent ink cartridges.

## Replacing Ink Cartridges



### Caution:

Be careful not to trap your hand or fingers when opening or closing the scanner unit. Otherwise you may be injured.



### Important:

Finish ink cartridge replacement promptly. Do not leave the printer with the ink cartridges removed.

### Note:

If you replace the ink cartridges while copying, the originals may move out of place. Press the  button to cancel and replace the originals.

- Do one of the following.
  - ❑ When prompted to replace ink cartridges  
Check which ink cartridge needs to be replaced, and then press the OK button. Select **Replace now** using the ▲ or ▼ button and press the OK button.
  - ❑ When replacing ink cartridges before they are expended  
Enter **Setup** from the home screen using the ◀ or ▶ button, and then press the OK button. Select **Maintenance** using the ◀ or ▶ button, and then press the OK button. Select **Ink Cartridge(s) Replacement** using the ◀ or ▶ button, and then press the OK button. Next, press the ◊ button.
- When replacing the black ink cartridge, gently shake the new black ink cartridge four or five times and then remove it from its package. When replacing other color cartridges and the photo black cartridge, remove the new color cartridges and the photo black cartridge from their package without shaking.

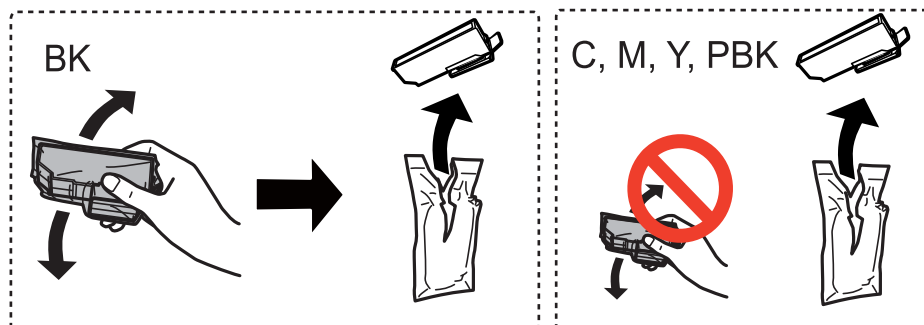

## Replacing Ink Cartridges

3. Remove the cap.

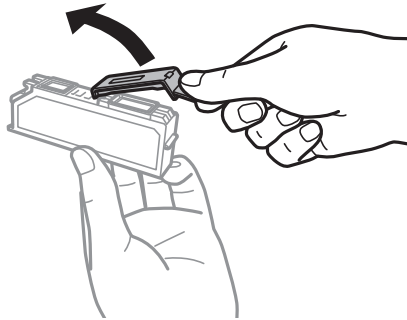

**!** *Important:*

- ❑ *Do not touch the sections shown in the illustration. Doing so may prevent normal operation and printing.*

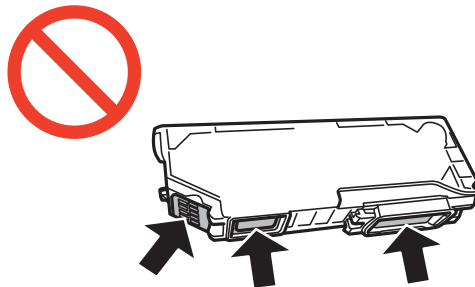

- ❑ *Do not shake cartridges after opening the package, as they may leak.*

4. Open the scanner unit with the document cover closed.

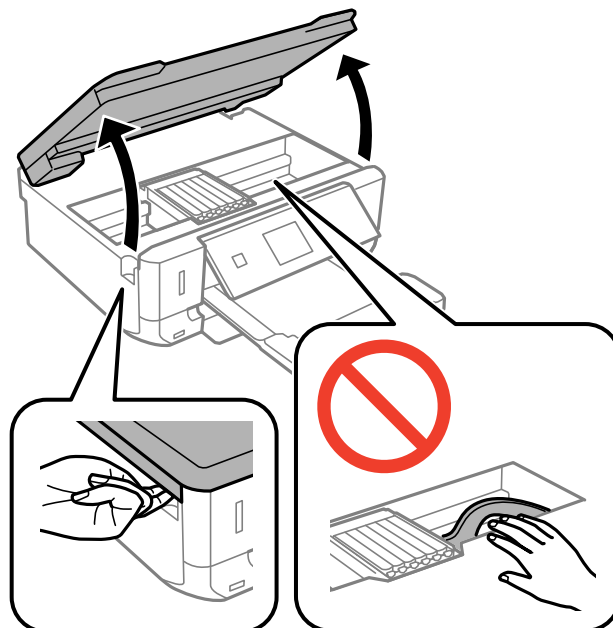

## Replacing Ink Cartridges

5. Push the tab to unlock the ink cartridge holder, and then remove the cartridge diagonally.

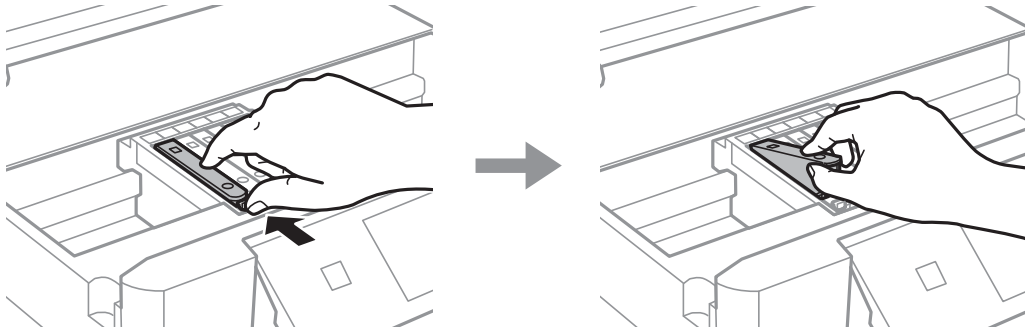

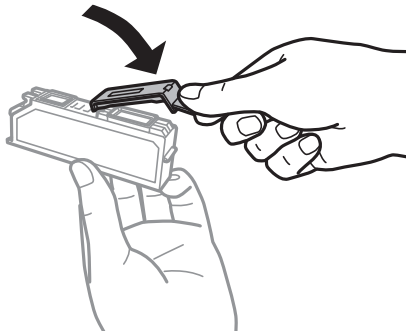

**!** **Important:**

*If you remove the cartridge from the printer for later use or to dispose of it, make sure you put the cap back on the cartridge's ink supply port to prevent ink from drying out or to prevent surrounding areas from getting smeared by ink.*

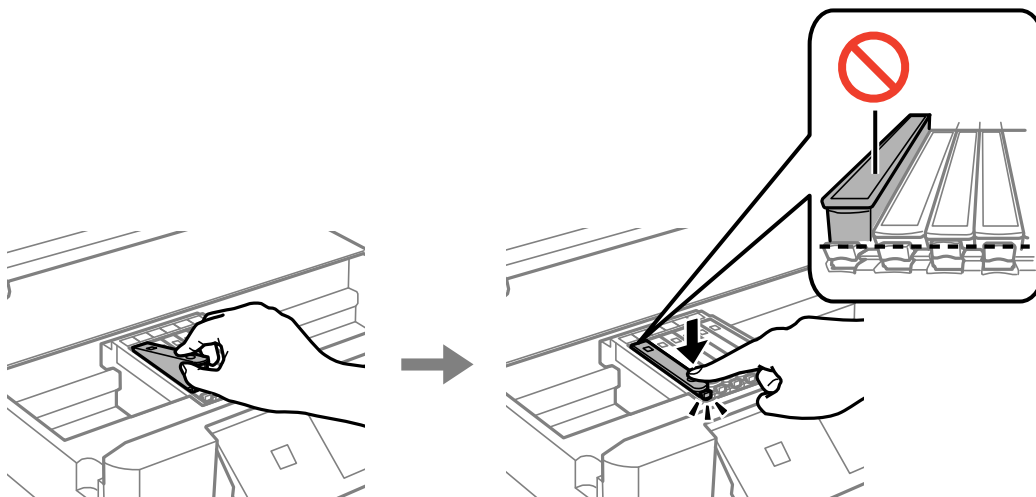

6. Insert the ink cartridge diagonally into the cartridge holder and gently push it down until it clicks into place.



7. Close the scanner unit, and then press the  button.

## Replacing Ink Cartridges

8. Follow the on-screen instructions.

**Important:**

*After installing the ink cartridge, the power light continues to flash while the printer is charging ink. Do not turn off the printer during ink charging. If the ink charging is incomplete, you may not be able to print.*

**Note:**

*Put used ink cartridges in a plastic bag and dispose of them according to your local laws and regulations.*

**Related Information**

- ➔ [“Ink Cartridge Codes” on page 74](#)
- ➔ [“Ink Cartridge Handling Precautions” on page 75](#)

---

## Temporarily Printing with Black Ink

When color ink or photo black ink is expended but black ink still remains while printing from a computer, you can use the following settings to continue printing for a short time using only black ink.

- Type of paper: plain papers, Envelope
- Color: **Grayscale**
- Borderless: Not selected
- EPSON Status Monitor 3: Enabled (for Windows only)

Because this feature is only available for approximately five days, replace the expended ink cartridge as soon as possible.

**Note:**

- If EPSON Status Monitor 3 is disabled, access the printer driver, click **Extended Settings** on the **Maintenance** tab, and then select **Enable EPSON Status Monitor 3**.*
- The available period varies depending on the usage conditions.*



## Replacing Ink Cartridges

## Temporarily Printing with Black Ink - Windows

1. When the following window is displayed, cancel printing.

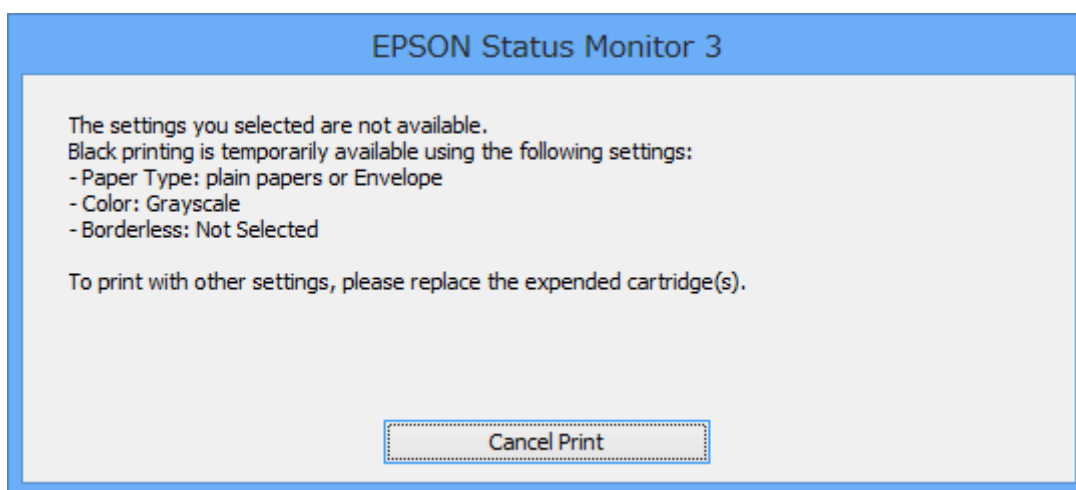
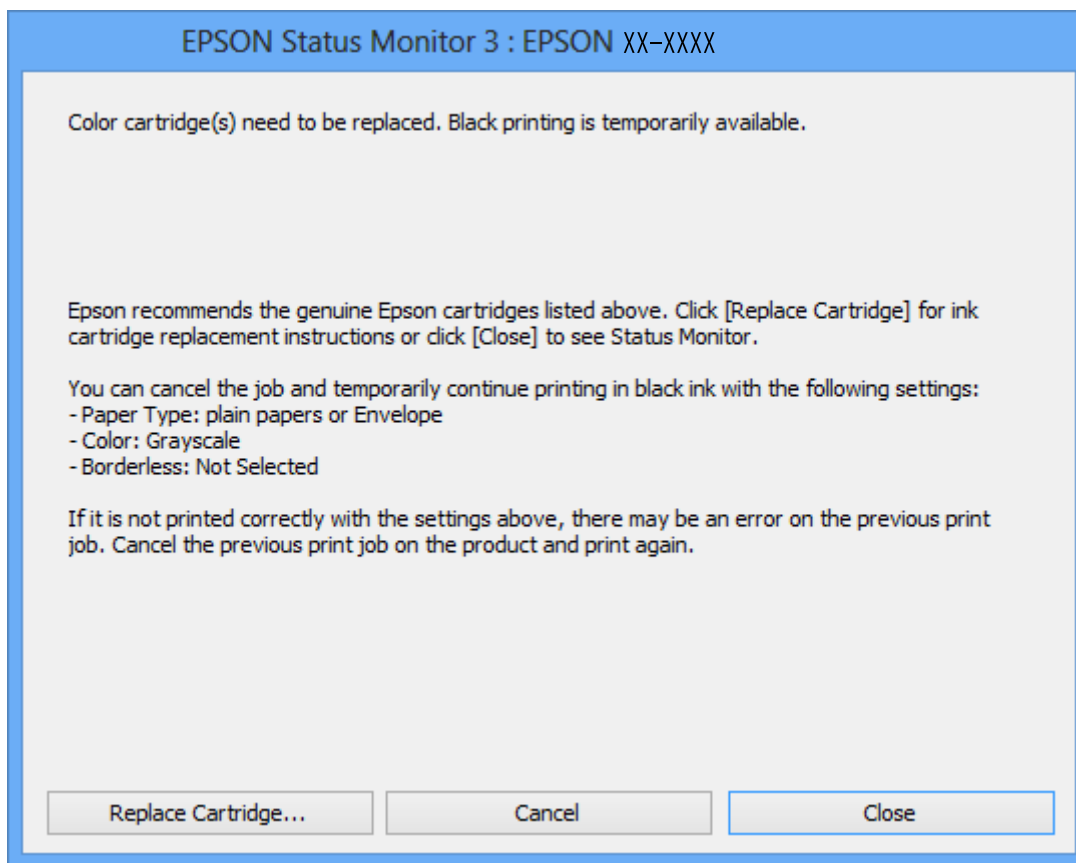
**Note:**

*If you cannot cancel printing from the computer, cancel using the printer's control panel.*

2. Access the printer driver window.
3. Clear **Borderless** on the **Main** tab.
4. Select **plain papers** or **Envelope** as the **Paper Type** setting on the **Main** tab.

## Replacing Ink Cartridges

5. Select **Grayscale**.
6. Set the other items on the **Main** and **More Options** tabs as necessary, and then click **OK**.
7. Click **Print**.
8. Click **Print in Black** in the window displayed.

### Related Information

- ➔ [“Loading Paper in the Paper Cassette” on page 27](#)
- ➔ [“Printing Basics - Windows” on page 41](#)

## Temporarily Printing with Black Ink - Mac OS X

### Note:

To use this feature through a network, connect with **Bonjour**.

1. Click the printer icon in the **Dock**.
2. Cancel the job.
  - Mac OS X v10.8.x to Mac OS X v10.9.x  
Click  next to the progress meter.
  - Mac OS X v10.6.x to v10.7.x  
Click **Delete**.

### Note:

If you cannot cancel printing from the computer, cancel using the printer's control panel.

3. Select **System Preferences** from the  menu > **Printers & Scanners** (or **Print & Scan, Print & Fax**), and then select the printer. Click **Options & Supplies > Options** (or **Driver**).
4. Select **On** as the **Permit temporary black printing** setting.
5. Access the print dialog.
6. Select **Print Settings** from the pop-up menu.
7. Select any paper size except for a borderless size as the **Paper Size** setting.
8. Select **plain papers** or **Envelope** as the **Media Type** setting.
9. Select **Grayscale**.
10. Set the other items as necessary.
11. Click **Print**.

### Related Information

- ➔ [“Loading Paper in the Paper Cassette” on page 27](#)
- ➔ [“Printing Basics - Mac OS X” on page 43](#)

## Conserving Black Ink when the Black Ink Is Low (for Windows Only)

When black ink is running low and there is enough color ink remaining, you can use a mixture of color inks to create black. You can continue printing while preparing a replacement black ink cartridge.

This feature is only available when you select the following settings in the printer driver.

- Paper Type: **plain papers**
- Quality: **Standard**
- EPSON Status Monitor 3: Enabled

**Note:**

- If **EPSON Status Monitor 3** is disabled, access the printer driver, click **Extended Settings** on the **Maintenance** tab, and then select **Enable EPSON Status Monitor 3**.
- Composite black looks slightly different from pure black. In addition, the print speed is reduced.
- To maintain the quality of the print head, black ink is also consumed.

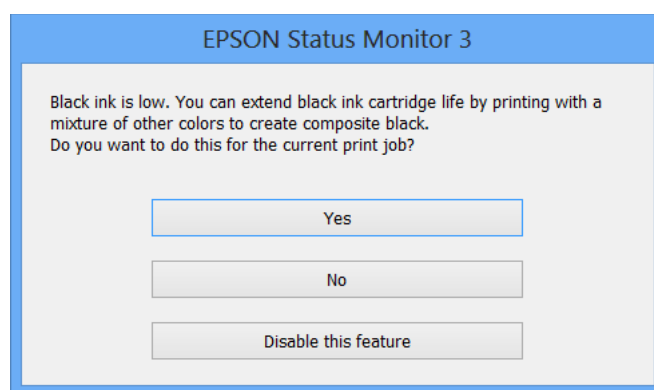

| Menu                 | Descriptions  |
|----------------------|---|
| Yes                  | Select to use a mixture of color inks and photo black ink to create black. This window is displayed the next time you print a similar job.      |
| No                   | Select to continue using the remaining black ink. This window is displayed the next time you print a similar job.                               |
| Disable this feature | Select to continue using the remaining black ink. This window is not displayed until you replace the black ink cartridge and it runs low again. |

# Improving Print and Scan Quality

## Checking and Cleaning the Print Head

If the nozzles are clogged, the printouts become faint, there is visible banding, or unexpected colors appear. When print quality has declined, use the nozzle check feature and check if the nozzles are clogged. If the nozzles are clogged, clean the print head.

### **Important:**

*Do not open the scanner unit or turn off the printer during head cleaning. If the head cleaning is incomplete, you may not be able to print.*

### **Note:**

- Because print head cleaning uses some ink, clean the print head only if quality declines.
- When ink is low you may not be able to clean the print head. Replace the appropriate ink cartridge first.
- If print quality has not improved after repeating nozzle check and head cleaning about two times, wait for at least six hours without printing, and then run the nozzle check again and repeat the head cleaning if necessary. If the printer operates printing while waiting, extend the waiting time. We recommend to turn off the printer. If print quality has still not improved, contact Epson support.
- To prevent the print head from drying out, always turn the printer off by pressing the  button.
- To keep the print head operating at its best, we recommend printing a few pages on a regular basis.

## Checking and Cleaning the Print Head - Control Panel

1. Load A4-size plain paper in the printer.
2. Enter **Setup** from the home screen using the ◀ or ▶ button, and then press the OK button.
3. Select **Maintenance** using the ◀ or ▶ button, and then press the OK button.
4. Select **Nozzle Check** using the ◀ or ▶ button, and then press the OK button.
5. Follow the on-screen instructions to print the nozzle check pattern.
6. Compare the printed check pattern with the sample shown below.
  - All lines are printed: The print head nozzles are not clogged. Select **No** using the ▲ or ▼ button and press the OK button.

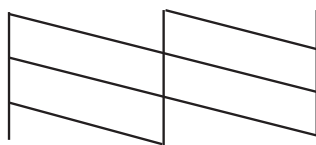

## Improving Print and Scan Quality

- ❑ There are broken lines or missing segments: The print head nozzles may be clogged. Go to the next step.

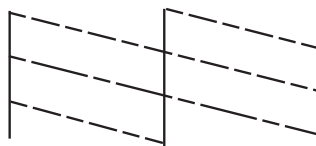

**Note:**

*The test pattern may vary by model.*

7. Select **Yes** using the ▼ or ▲ button, and then press the OK button.
8. Follow the on-screen instructions to clean the print head.
9. When cleaning is finished, select **Nozzle Check** using the ▼ or ▲ button, and then follow the on-screen instructions to print the nozzle check pattern again. Repeat cleaning and printing the pattern until all lines are printed completely.

### Related Information

- ➔ [“Loading Paper in the Paper Cassette” on page 27](#)

## Checking and Cleaning the Print Head - Windows

1. Load A4-size plain paper in the printer.
2. Access the printer driver window.
3. Click **Nozzle Check** on the **Maintenance** tab.
4. Follow the on-screen instructions.

### Related Information

- ➔ [“Loading Paper in the Paper Cassette” on page 27](#)
- ➔ [“Windows Printer Driver” on page 90](#)

## Checking and Cleaning the Print Head - Mac OS X

1. Load A4-size plain paper in the printer.
2. Select **System Preferences** from the  menu > **Printers & Scanners** (or **Print & Scan**, **Print & Fax**), and then select the printer.
3. Click **Options & Supplies** > **Utility** > **Open Printer Utility**.
4. Click **Nozzle Check**.
5. Follow the on-screen instructions.

**Related Information**

➔ [“Loading Paper in the Paper Cassette” on page 27](#)

---

## Aligning the Print Head

If you notice a misalignment of vertical lines or blurred images, align the print head.

### Aligning the Print Head - Control Panel

1. Load A4-size plain paper in the printer.
2. Enter **Setup** from the home screen using the ◀ or ▶ button, and then press the OK button.
3. Select **Maintenance** using the ◀ or ▶ button, and then press the OK button.
4. Select **Head Alignment** using the ◀ or ▶ button, and then press the OK button.
5. Follow the on-screen instructions to print the alignment pattern.
6. Follow the on-screen instructions to align the print head. Find and select the number for the most solid pattern in each group using the ▲ or ▼ button, and then press the OK button.

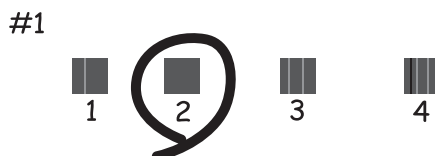
**Note:**

❑ The test pattern may vary by model.

❑ If print quality is not improved, align the print head from a computer.

**Related Information**

➔ [“Loading Paper in the Paper Cassette” on page 27](#)

### Aligning the Print Head - Windows

1. Load A4-size plain paper in the printer.
2. Access the printer driver window.
3. Click **Print Head Alignment** on the **Maintenance** tab.

## Improving Print and Scan Quality

4. Follow the on-screen instructions.

### Related Information

- ➔ [“Loading Paper in the Paper Cassette” on page 27](#)
- ➔ [“Windows Printer Driver” on page 90](#)

## Aligning the Print Head - Mac OS X

1. Load A4-size plain paper in the printer.
2. Select **System Preferences** from the  menu > **Printers & Scanners** (or **Print & Scan, Print & Fax**), and then select the printer.
3. Click **Options & Supplies** > **Utility** > **Open Printer Utility**.
4. Click **Print Head Alignment**.
5. Follow the on-screen instructions.

### Related Information

- ➔ [“Loading Paper in the Paper Cassette” on page 27](#)

---

## Cleaning the Paper Path

When the printouts are smeared or scuffed or paper does not feed correctly, clean the roller inside. You cannot use the cleaning sheet that came with the paper.

**Important:**

*Do not use tissue paper to clean the inside of the printer. The print head nozzles may be clogged with lint.*

1. Make sure there is no dust or stains on the scanner glass and the document cover.
2. Load A4-size plain paper in the paper cassette.
3. Start copying without placing the original.

**Note:**

*Repeat this procedure until the paper is not smeared with ink.*

### Related Information

- ➔ [“Loading Paper in the Paper Cassette” on page 27](#)
- ➔ [“Copying Basics” on page 63](#)

---

## Cleaning the Scanner Glass

When the copies or scanned images are smeared or scuffed, clean the scanner glass.

## Improving Print and Scan Quality



**Important:**

*Never use alcohol or thinner to clean the printer. These chemicals can damage the printer.*

1. Open the document cover.

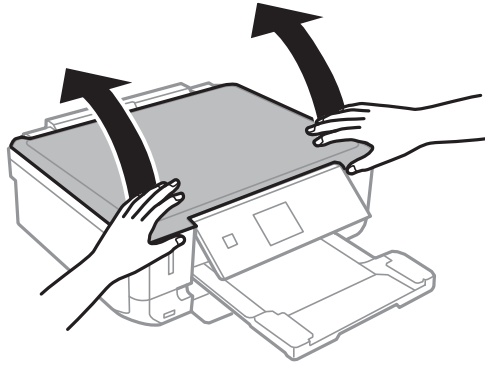

2. Use a soft, dry, clean cloth to clean the surface of the scanner glass.

**Note:**

- If the glass surface is stained with grease or some other hard-to-remove material, use a small amount of glass cleaner and a soft cloth to remove it. Wipe off all remaining liquid.*
- Do not press the glass surface too hard.*
- Be careful not to scratch or damage the surface of the glass. A damaged glass surface can decrease the scan quality.*



# Applications and Network Service Information

## Epson Connect Service

Using Epson Connect, you can print from your smartphone, tablet PC, or laptop, anytime and practically anywhere.

The following features are available for your printer.

| Email Print | Epson iPrint remote print | Scan to Cloud | Remote Print Driver |
|-------------|---------------------------|---------------|---------------------|
| ✓           | ✓                         | –             | ✓                   |

See the Epson Connect portal website for details.

<https://www.epsonconnect.com/>

<http://www.epsonconnect.eu> (Europe only)

## Web Config

Web Config is an application that allows you to manage the printer status or settings on a Web browser from a computer or smart device. You can confirm the printer status or change the network and printer settings. To use the Web Config, connect the printer and device to the same network.

**Note:**

*The following browsers are supported.*

| OS                        | Browser   |
|---------------------------|---|
| Windows XP or later       | Internet Explorer 8 or later, Firefox*, Chrome* |
| Mac OS X v10.6.x or later | Safari*, Firefox*, Chrome*                      |
| iOS*                      | Safari*   |
| Android 2.3 or later      | Default browser                                 |
| Chrome OS*                | Default browser                                 |

\*: Use the latest version.

## Running Web Config on a Web Browser

1. Check the printer's IP address.

Select **Setup** > **Network Settings** > **Print Status Sheet** from the control panel, and then press the  button or the OK button. Check the printer's IP address on the printed status sheet.

## Applications and Network Service Information

2. Launch a Web browser from a computer or smart device, and then enter the printer's IP address.

Format:

IPv4: http://the printer's IP address/

IPv6: http://[the printer's IP address]/

Examples:

IPv4: http://192.168.100.201/

IPv6: http://[2001:db8::1000:1]/

**Note:**

*Using the smart device, you can also run Web Config from the maintenance screen of Epson iPrint.*

### Related Information

- ➔ [“Using Epson iPrint” on page 59](#)

## Running Web Config on Windows

1. Access the devices and printers screen in Windows.
  - Windows 8.1/Windows 8  
Select **Desktop > Settings > Control Panel > View devices and printers in Hardware and Sound (or Hardware)**.
  - Windows 7  
Click the start button, and select **Control Panel > View devices and printers in Hardware and Sound**.
  - Windows Vista  
Click the start button, and select **Control Panel > Printers in Hardware and Sound**.
2. Right-click on your printer and select **Properties**.
3. Select the **Web Service** tab and click the URL.

## Running Web Config on Mac OS X

1. Select **System Preferences** from the  menu > **Printers & Scanners** (or **Print & Scan, Print & Fax**), and then select the printer.
2. Click **Options & Supplies > Show Printer Webpage**.

---

## Necessary Applications

### Windows Printer Driver

The printer driver is an application that controls the printer according to the print commands from other applications. Making settings on the printer driver provides the best printing results. You can also check the status of the printer or keep it in top operating condition using the printer driver utility.

## Applications and Network Service Information

**Note:**

You can change the language of the printer driver. Select the language you want to use from the **Language** setting on the **Maintenance** tab.

### Accessing the printer driver from applications

To make settings that apply only to the application you are using, access from that application.

Select **Print** or **Print Setup** from the **File** menu. Select your printer, and then click **Preferences** or **Properties**.

**Note:**

Operations differ depending on the application. See the application's help for details.

### Accessing the printer driver from the control panel

To make settings that apply to all of the applications, access from the control panel.

Windows 8.1/Windows 8

Select **Desktop > Settings > Control Panel > View devices and printers in Hardware and Sound**. Right-click on your printer, or press and hold it and then select **Printing preferences**.

Windows 7

Click the start button, and select **Control Panel > View devices and printers in Hardware and Sound**. Right-click on your printer and select **Printing preferences**.

Windows Vista

Click the start button, and select **Control Panel > Printers in Hardware and Sound**. Right-click on your printer and select **Printing preferences**.

Windows XP

Click the start button, and select **Control Panel > Printers and Other Hardware > Printers and Faxes**. Right-click on your printer and select **Printing preferences**.

### Accessing the printer driver from the printer icon on the task bar (Windows)

The printer icon on the desktop task bar is a shortcut icon allowing you to quickly access the printer driver.

If you click the printer icon and select **Printer Settings**, you can access the same printer settings window as the one displayed from the control panel. If you double-click this icon, you can check the status of the printer.

**Note:**

If the printer icon is not displayed on the task bar, access the printer driver window, click **Monitoring Preferences** on the **Maintenance** tab, and then select **Register the shortcut icon to the taskbar**.

## Guide to Windows Printer Driver

Help is available in the printer driver for Windows. To view explanations of the setting items, right-click on each item, and then click **Help**.

### Main Tab

You can make basic settings for printing, such as paper type or paper size.

## Applications and Network Service Information

You can also make settings for printing both sides of the paper or printing multiple pages on one sheet.

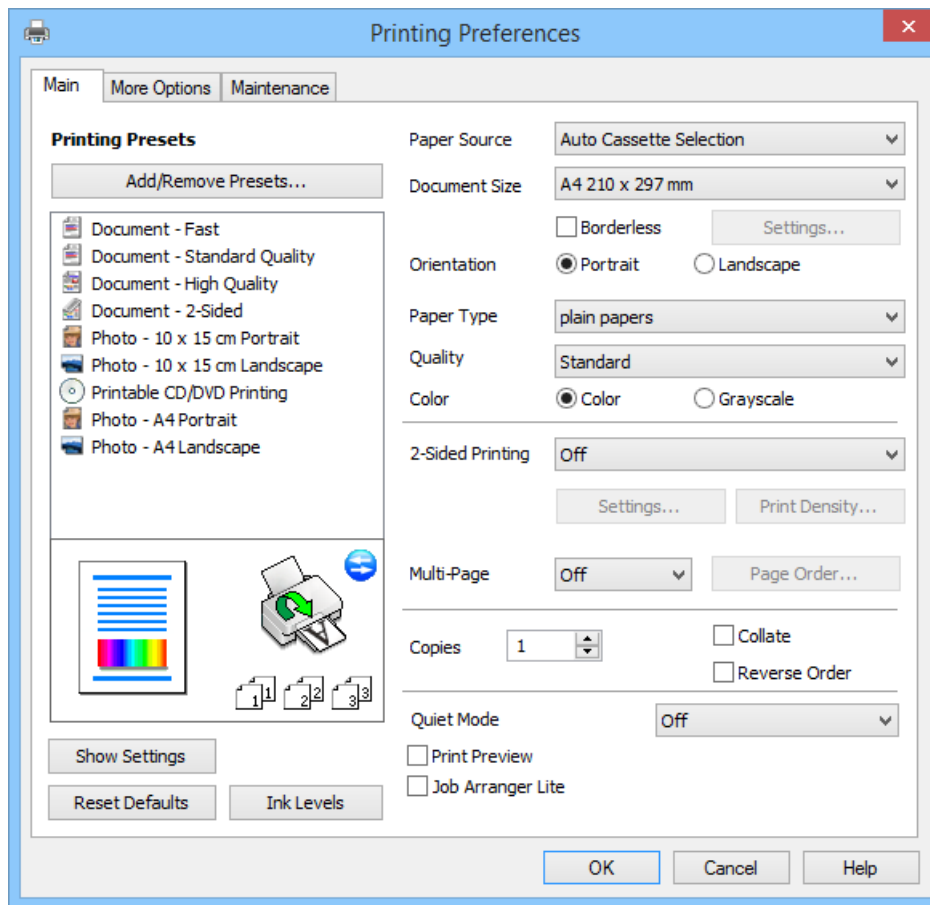

## Applications and Network Service Information

### More Options Tab

You can select additional layout and printing options such as changing the size of a printout or making color corrections.

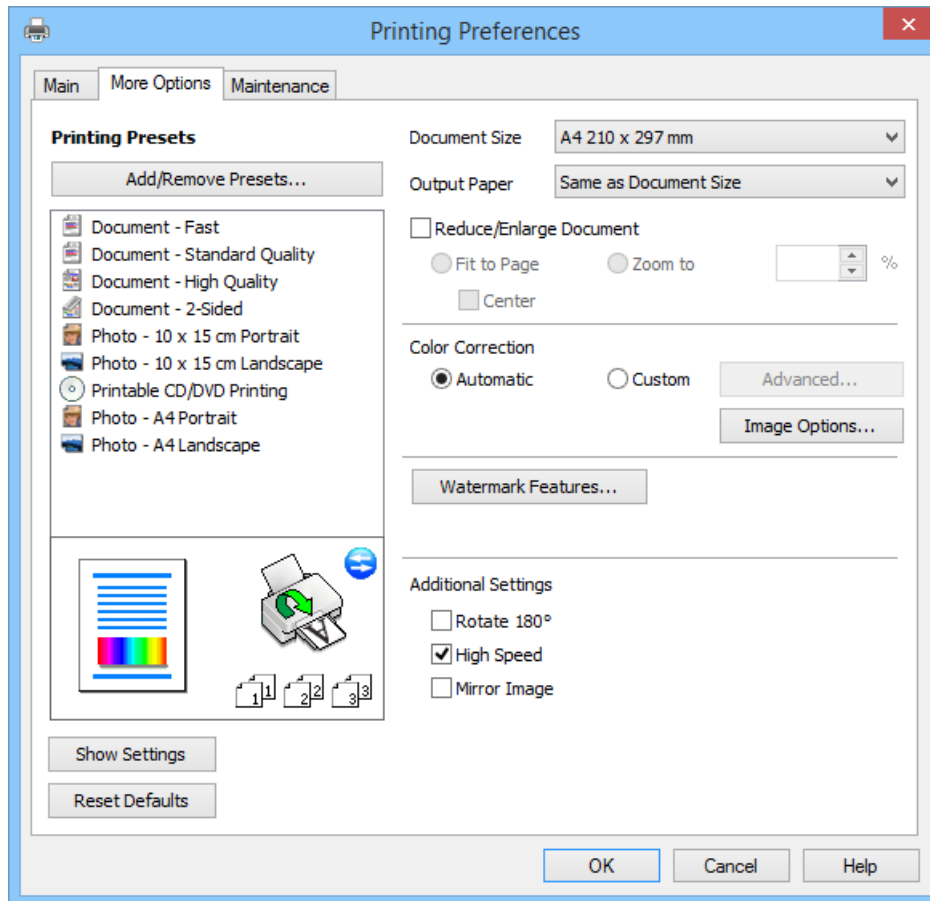

## Applications and Network Service Information

### Maintenance Tab

You can check the approximate ink levels and error information, and also maintain your printer, such as nozzle check or print head cleaning.

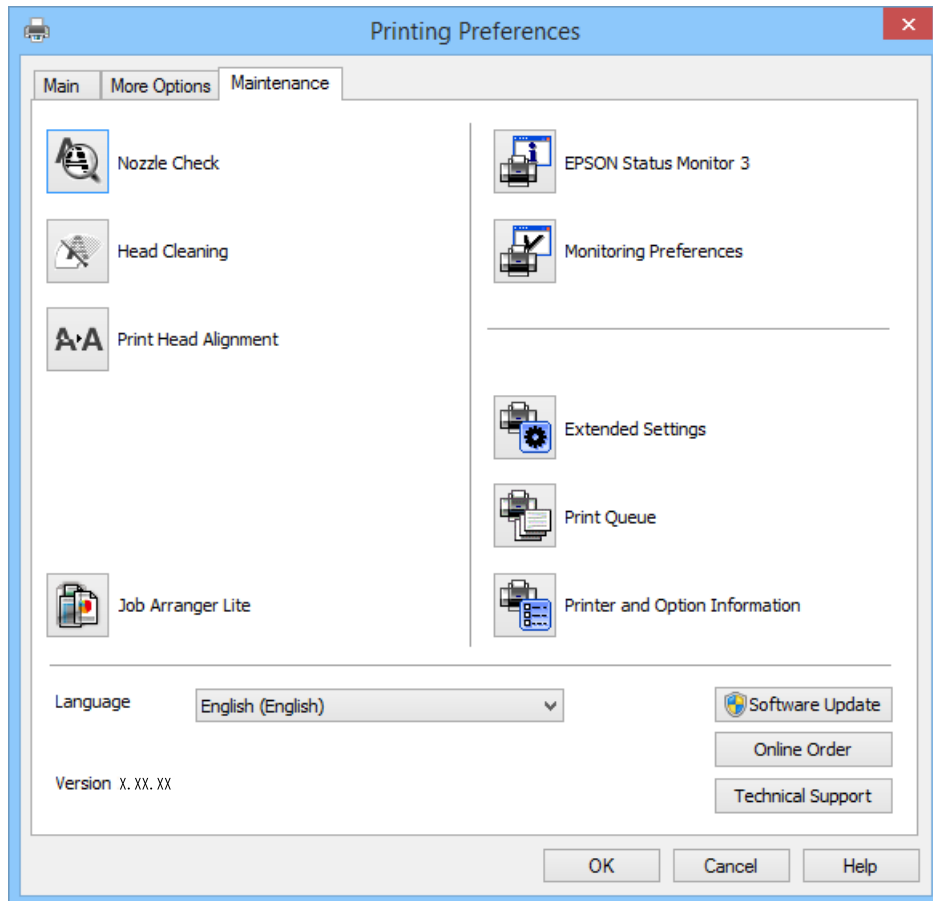

### Making Operation Settings for the Windows Printer Driver

You can make settings such as enabling **EPSON Status Monitor 3**.

1. Access the printer driver window.
2. Click **Extended Settings** on the **Maintenance** tab.
3. Make the appropriate settings, and then click **OK**.  
See the online help for explanations of the setting items.

#### Related Information

➔ [“Windows Printer Driver” on page 90](#)

### Mac OS X Printer Driver

The printer driver is an application that controls the printer according to the print commands from other applications. Making settings on the printer driver provides the best printing results. You can also check the status of the printer or keep it in top operating condition using the printer driver utility.

## Applications and Network Service Information

### Accessing the printer driver from applications

Select **Print** from the **File** menu. If necessary, click **Show Details** (or ▼) to expand the print window.

**Note:**

Operations differ depending on the application. See the application's help for details.

### Starting the utility

Select **System Preferences** from the  menu > **Printers & Scanners** (or **Print & Scan, Print & Fax**), and then select the printer. Click **Options & Supplies** > **Utility** > **Open Printer Utility**.

## Guide to Mac OS X Printer Driver

### Printer Driver Screen

Switch the pop-up menu on the center of the screen to show more items.

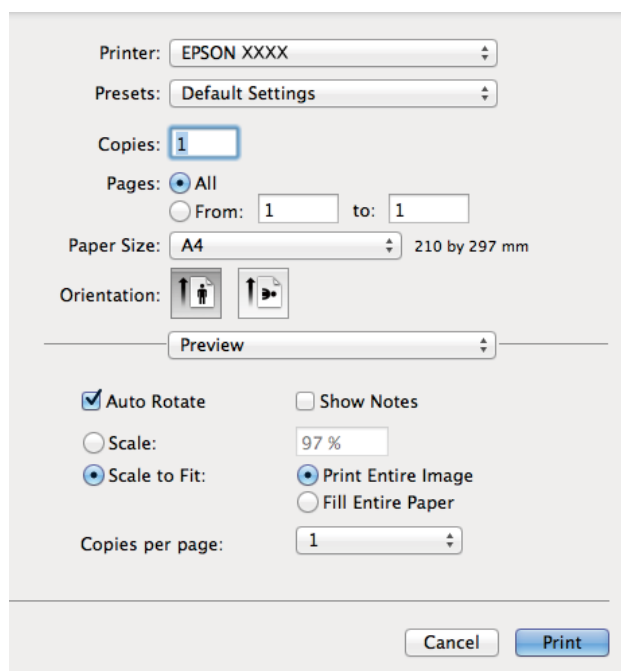

| Pop-up Menu                 | Descriptions  |
|-----------------------------|---|
| Print Settings              | You can make basic settings for printing, such as paper type or borderless printing.  |
| Two-sided Printing Settings | You can select a binding direction for 2-sided printing or select a document type. This menu is only displayed for automatic 2-sided printing capable models. |
| Layout                      | You can select a layout for printing several pages on one sheet or select to print a border.  |
| Paper Handling              | You can reduce or enlarge the size of the print job to automatically fit the paper size you loaded.   |
| Color Matching              | You can adjust the colors.  |

## Applications and Network Service Information

### Note:

On Mac OS X v10.8.x or later, if **Print Settings** menu is not displayed, Epson printer driver has not been installed correctly.

Select **System Preferences** from the  menu > **Printers & Scanners** (or **Print & Scan**, **Print & Fax**), remove the printer, and then add the printer again. See the following to add a printer.

<http://epson.sn>

### Epson Printer Utility

You can check the approximate ink levels and error information, and also maintain your printer, such as nozzle check or print head cleaning.

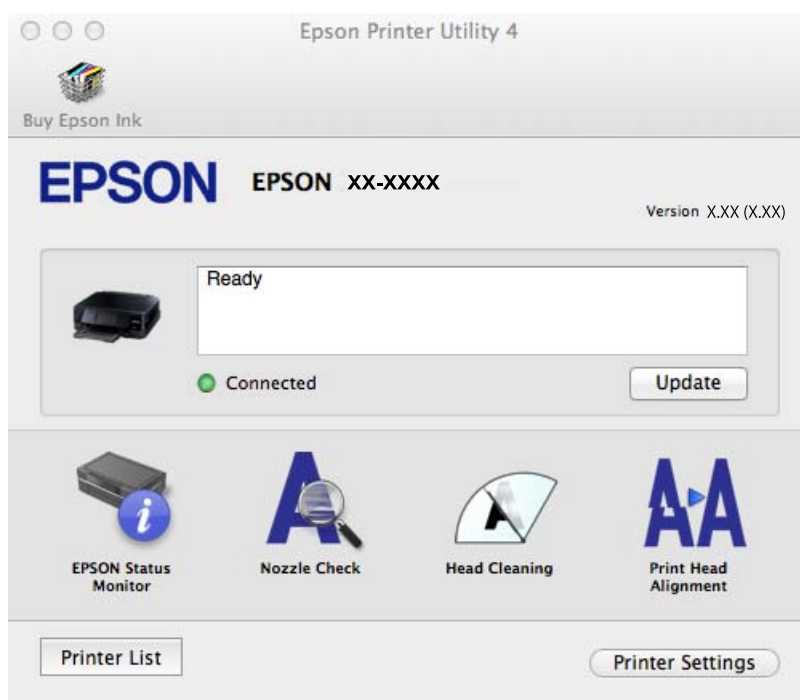

## Making Operation Settings for the Mac OS X Printer Driver

You can make various settings such as skipping blank pages and enabling/disabling high speed printing.

1. Select **System Preferences** from the  menu > **Printers & Scanners** (or **Print & Scan**, **Print & Fax**), and then select the printer. Click **Options & Supplies** > **Options** (or **Driver**).
2. Make the appropriate settings, and then click **OK**.
  - Thick paper and envelopes: Prevents the ink from smearing when printing on thick paper. However, the print speed may be slower.
  - Skip Blank Page: Avoids printing blank pages.
  - Quiet Mode: Prints quietly. However, the print speed may be slower.
  - Permit temporary black printing: Prints only with black ink temporarily.
  - High Speed Printing: Prints when the print head moves in both directions. The print speed is faster, but the quality may decline.
  - Remove white borders: Removes unnecessary margins during borderless printing.
  - Warning Notifications: Allows the printer driver to display warning notifications.



## Applications and Network Service Information

- Establish bidirectional communication: Usually, this should be set to **On**. Select **Off** when acquiring the printer information is impossible because the printer is shared with Windows computers on a network or for any other reason.
- Lower Cassette: Add the optional paper cassette units to the paper source.

**Note:**

*The availability of these settings varies by model.*

### Related Information

➔ [“Temporarily Printing with Black Ink” on page 80](#)

## EPSON Scan (Scanner Driver)

EPSON Scan is an application for controlling scanning. You can adjust the size, resolution, brightness, contrast, and quality of the scanned image.

**Note:**

*You can also start EPSON Scan from a TWAIN-compliant scanning application.*

### Starting on Windows

- Windows 8.1/Windows 8

Enter the application name in the search charm, and then select the displayed icon.

- Except for Windows 8.1/Windows 8

Click the start button, and select **All Programs** or **Programs > EPSON > EPSON Scan > EPSON Scan**.

### Starting on Mac OS X

**Note:**

*EPSON Scan does not support the Mac OS X fast user switching feature. Turn off fast user switching.*

Select **Go > Applications > Epson Software > EPSON Scan**.

## Epson Event Manager

Epson Event Manager is an application that allows you to manage scanning from the control panel and save images to a computer. You can add your own settings as presets, such as the document type, the save folder location, and the image format. See the application's help for details.

### Starting on Windows

- Windows 8.1/Windows 8

Enter the application name in the search charm, and then select the displayed icon.

- Except for Windows 8.1/Windows 8

Click the start button, and select **All Programs** or **Programs > Epson Software > Event Manager**.

### Starting on Mac OS X

Select **Go > Applications > Epson Software > Event Manager**.

## Applications and Network Service Information

### Related Information

➔ [“Scanning to a Computer” on page 65](#)

## Epson Easy Photo Print

Epson Easy Photo Print is an application that allows you to easily print photos with various layouts. You can preview the photo image and adjust the images or position. You can also print photos with a frame. See the application's help for details.

### Note:

*To use this application, the printer driver needs to be installed.*

### Starting on Windows

- Windows 8.1/Windows 8

Enter the application name in the search charm, and then select the displayed icon.

- Except for Windows 8.1/Windows 8

Click the start button, and then select **All Programs** or **Programs** > **Epson Software** > **Epson Easy Photo PrintE-Photo**.

### Starting on Mac OS X

Select **Go** > **Applications** > **Epson Software** > **Epson Easy Photo Print**.

## E-Web Print (for Windows Only)

E-Web Print is an application that allows you to easily print web pages with various layouts. See the application's help for details. You can access the help from the **E-Web Print** menu on the **E-Web Print** tool bar.

### Starting

When you install E-Web Print, it is displayed in your browser. Click **Print** or **Clip**.

## Easy Photo Scan

Easy Photo Scan is an application that allows you to scan photos and easily send the scanned image to a computer or cloud service. You can also easily adjust the scanned image. See the application's help for details.

### Note:

*To use this application, the scanner driver EPSON Scan needs to be installed.*

### Starting on Windows

- Windows 8.1/Windows 8

Enter the application name in the search charm, and then select the displayed icon.

- Except for Windows 8.1/Windows 8

Click the start button, and select **All Programs** or **Programs** > **Epson Software** > **Easy Photo Scan**.

### Starting on Mac OS X

Select **Go** > **Applications** > **Epson Software** > **Easy Photo Scan**.

## EPSON Software Updater

EPSON Software Updater is an application that checks for new or updated software on the internet and installs it. You can also update the printer's firmware and manual.

### Starting on Windows

- Windows 8.1/Windows 8

Enter the application name in the search charm, and then select the displayed icon.

- Except for Windows 8.1/Windows 8

Click the start button, and select **All Programs** (or **Programs**) > **Epson Software** > **EPSON Software Updater**.

#### **Note:**

*You can also start EPSON Software Updater by clicking the printer icon on the task bar on the desktop, and then selecting Software Update.*

### Starting on Mac OS X

Select **Go** > **Applications** > **Epson Software** > **EPSON Software Updater**.

---

## Uninstalling Applications

#### **Note:**

*Log on to your computer as an administrator. Enter the administrator password if the computer prompts you.*

### Uninstalling Applications - Windows

1. Press the  button to turn off the printer.
2. Quit all running applications.
3. Open **Control Panel**:
  - Windows 8.1/Windows 8  
Select **Desktop** > **Settings** > **Control Panel**.
  - Except for Windows 8.1/Windows 8  
Click the start button and select **Control Panel**.
4. Open **Uninstall a program** (or **Add or Remove Programs**):
  - Windows 8.1/Windows 8/Windows 7/Windows Vista  
Select **Uninstall a program** in **Programs**.
  - Windows XP  
Click **Add or Remove Programs**.
5. Select the application you want to uninstall.
6. Uninstall the applications:
  - Windows 8.1/Windows 8/Windows 7/Windows Vista  
Click **Uninstall/Change** or **Uninstall**.

## Applications and Network Service Information

- Windows XP



Click **Change/Remove** or **Remove**.

**Note:**

If the **User Account Control** window is displayed, click **Continue**.

7. Follow the on-screen instructions.

## Uninstalling Applications - Mac OS X

1. Download the Uninstaller using EPSON Software Updater.  
Once you have downloaded the Uninstaller, you do not need to download it again each time you uninstall the application.
2. Turn off the printer by pressing the  button.
3. To uninstall the printer driver, select **System Preferences** from the  menu > **Printers & Scanners** (or **Print & Scan, Print & Fax**), and then remove the printer from the enabled printers list.
4. Quit all running applications.
5. Select **Go > Applications > Epson Software > Uninstaller**.
6. Select the application you want to uninstall, and then click **Uninstall**.



**Important:**

The Uninstaller removes all drivers for Epson inkjet printers on the computer. If you use multiple Epson inkjet printers and you only want to delete some drivers, delete all of them first, and then install the necessary printer driver again.

**Note:**

If you cannot find the application you want to uninstall in the application list, you cannot uninstall using the Uninstaller. In this situation, select **Go > Applications > Epson Software**, select the application you want to uninstall, and then drag it to the trash icon.

### Related Information

- ➔ [“EPSON Software Updater” on page 99](#)

---

## Installing Applications

If your computer is connected to a network, install the latest applications available on the website. If you are unable to download the applications from the website, install them from the software disc that came with the printer.

**Note:**

- Log on to your computer as an administrator. Enter the administrator password if the computer prompts you.
- When reinstalling an application, you need to uninstall it first.

1. Quit all running applications.

## Applications and Network Service Information

2. When installing the printer driver or EPSON Scan, disconnect the printer and the computer temporarily.

**Note:**

*Do not connect the printer and the computer until you are instructed to do so.*

3. Install the applications by following the instructions on the website below.

<http://epson.sn>

### Related Information

➔ “Uninstalling Applications” on page 99

---

## Updating Applications and Firmware

You may be able to clear certain problems and improve or add functions by updating the applications and the firmware. Make sure you use the latest version of the applications and firmware.

1. Make sure that the printer and the computer are connected, and the computer is connected to the internet.
2. Start EPSON Software Updater, and update the applications or the firmware.



**Important:**

*Do not turn off the computer or the printer while updating.*

**Note:**

*If you cannot find the application you want to update in the list, you cannot update using the EPSON Software Updater. Check for the latest versions of the applications from your local Epson website.*

<http://www.epson.com>

### Related Information

➔ “EPSON Software Updater” on page 99

# Solving Problems

## Checking the Printer Status

### Checking Error Codes on the LCD Screen

A code is displayed on the LCD screen if there is an error or information that requires your attention.

| Code | Situation   | Solutions  |
|------|---|--|
| E-01 | A printer error has occurred.                                   | Open the scanner unit and remove any paper or protective material inside the printer. Turn the power off and on again.   |
| E-02 | A scanner error has occurred.                                   | Turn the power off and on again.   |
| E-11 | An ink pad needs to be replaced.                                | Contact Epson or an authorised Epson service provider to replace the ink pad*. It is not a user-serviceable part.  |
| W-01 | A paper jam has occurred in the paper cassette.                 | Remove the paper from the printer and press the button displayed on the bottom of the LCD screen to clear the error. In some case, you need to turn the power off and on again.  |
| W-02 | A paper jam has occurred inside the printer.                    |  |
| W-03 | A paper jam has occurred in the rear of the printer.            |  |
| W-11 | An ink pad is nearing the end of its service life.              | Contact Epson or an authorised Epson service provider to replace the ink pad*. It is not a user-serviceable part. The message will be displayed until the ink pad is replaced.<br><br>Press the  button to resume printing. |
| W-12 | Ink cartridges are installed incorrectly.                       | Press down each of the ink cartridges gently. Make sure they click into place.   |
| W-13 | The installed ink cartridges cannot be used with this printer.  | Replace the ink cartridges with cartridges that are compatible with this printer.  |
| I-01 | The CD/DVD tray has not been inserted.                          | Insert the CD/DVD tray.  |
| I-22 | Set Wi-Fi using the <b>Push Button (WPS)</b> .                  | Push the access point button. If there is no button on the access point, open the access point setting window, and then click the button displayed in the software.  |
| I-23 | Set Wi-Fi using the <b>PIN Code (WPS)</b> .                     | Enter the PIN code displayed on the LCD screen into the access point or computer within two minutes.   |
| I-31 | Set Wi-Fi using the <b>Wi-Fi Auto Connect</b> .                 | Install the software on your computer, and then press the OK button when Wi-Fi setup starts.   |
| I-41 | Paper Configuration is disabled. Some functions cannot be used. | If <b>Paper Configuration</b> is disabled, you cannot use AirPrint. In addition, messages notifying you that the paper size and type do not match are not displayed. Keep this setting enabled unless you always use the same size and type of paper and do not need to change the paper settings.             |

## Solving Problems

| Code          | Situation  | Solutions   |
|---------------|--|---|
| I-61          | Your computer may not support WSD (Web Services for Devices).                | The scan to computer (WSD) feature is only available for computers running English versions of Windows 8.1, Windows 8, Windows 7 or Windows Vista. Make sure that the printer is correctly connected to the computer. See the <i>Network Guide</i> for more details.              |
| I-71          | -  | Place the originals on the scanner glass to copy in <b>A4, 2-up Copy</b> layout.  |
| I-72          | -  | Place a disc or photo on the scanner glass for copying.   |
| I-73          | -  | Place a photo on the scanner glass for copying.   |
| I-74<br>I-75  | -  | Place a template sheet on which you have written a message and so on to create a greeting card on the scanner glass.  |
| Recovery Mode | The printer has started in recovery mode because the firmware update failed. | Follow the steps below to try to update the firmware again.<br><br>1. Connect the computer and the printer with a USB cable. (During recovery mode, you cannot update the firmware over a network connection.)<br><br>2. Visit your local Epson website for further instructions. |

\* In some print cycles a very small amount of surplus ink may be collected in the ink pad. To prevent ink leakage from the pad, the product is designed to stop printing when the pad has reached its limit. Whether and how often this is required varies according to the number of pages you print, the type of material that you print, and the number of cleaning cycles that the printer performs. The need for replacement of the pad does not mean that your printer has ceased to operate in accordance with its specifications. The printer will advise you when the pad requires replacing and this can only be performed by an authorised Epson Service provider. The Epson warranty does not cover the cost of this replacement.

### Related Information

- ➔ [“Contacting Epson Support” on page 131](#)
- ➔ [“Removing Jammed Paper” on page 104](#)
- ➔ [“Printing Photos from a Memory Card with Handwritten Notes” on page 38](#)
- ➔ [“Copying Photos” on page 63](#)
- ➔ [“Printing Photos from a Memory Card with Handwritten Notes” on page 38](#)

## Checking the Printer Status - Windows

1. Access the printer driver window.
2. Click **EPSON Status Monitor 3** on the **Maintenance** tab.

**Note:**

- You can also check the printer status by double-clicking the printer icon on the taskbar. If the printer icon is not added to the taskbar, click **Monitoring Preferences** on the **Maintenance** tab, and then select **Register the shortcut icon to the taskbar**.
- If **EPSON Status Monitor 3** is disabled, click **Extended Settings** on the **Maintenance** tab, and then select **Enable EPSON Status Monitor 3**.

## Solving Problems

### Related Information

➔ [“Windows Printer Driver” on page 90](#)

## Checking Printer Status - Mac OS X

1. Select **System Preferences** from the  menu > **Printers & Scanners** (or **Print & Scan, Print & Fax**), and then select the printer.
2. Click **Options & Supplies** > **Utility** > **Open Printer Utility**.
3. Click **EPSON Status Monitor**.

---

## Removing Jammed Paper

Check the error displayed on the control panel and follow the instructions to remove the jammed paper including any torn pieces. Next, clear the error.

**Important:**

*Remove the jammed paper carefully. Removing the paper vigorously may cause damage to the printer.*

## Removing Jammed Paper from the Paper Cassette

1. Close the output tray.
2. Pull out the paper cassette.

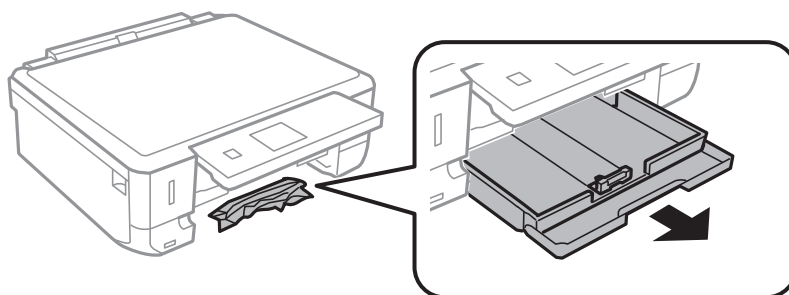

3. Remove the jammed paper.

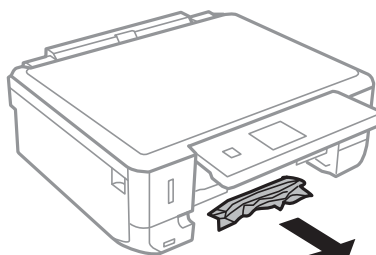



## Solving Problems

- Align the edges of the paper and slide the edge guides to the edges of the paper.

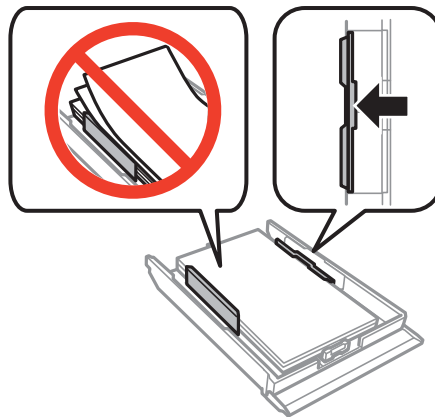

- Insert the paper cassette in the printer.

## Removing Jammed Paper from Inside the Printer

 **Caution:**

- Be careful not to trap your hand or fingers when opening or closing the scanner unit. Otherwise you may be injured.
- Never touch the buttons on the control panel while your hand is inside the printer. If the printer starts operating, it could cause an injury. Be careful not to touch the protruding parts to avoid injury.

- Open the scanner unit with the document cover closed.

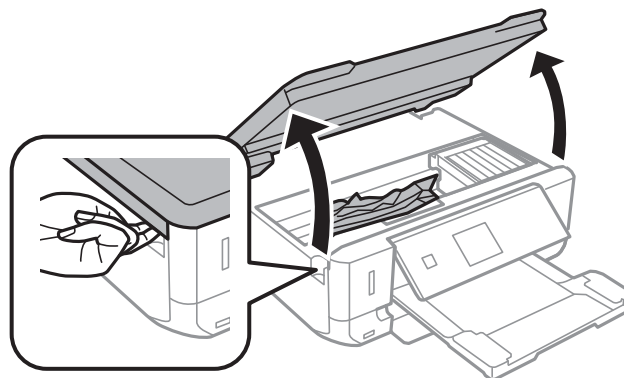

## Solving Problems

2. Remove the jammed paper.

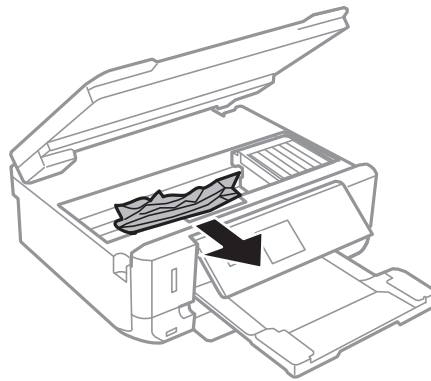

**!** *Important:*

*Do not touch the white flat cable or translucent part inside the printer. Doing so may cause a malfunction.*

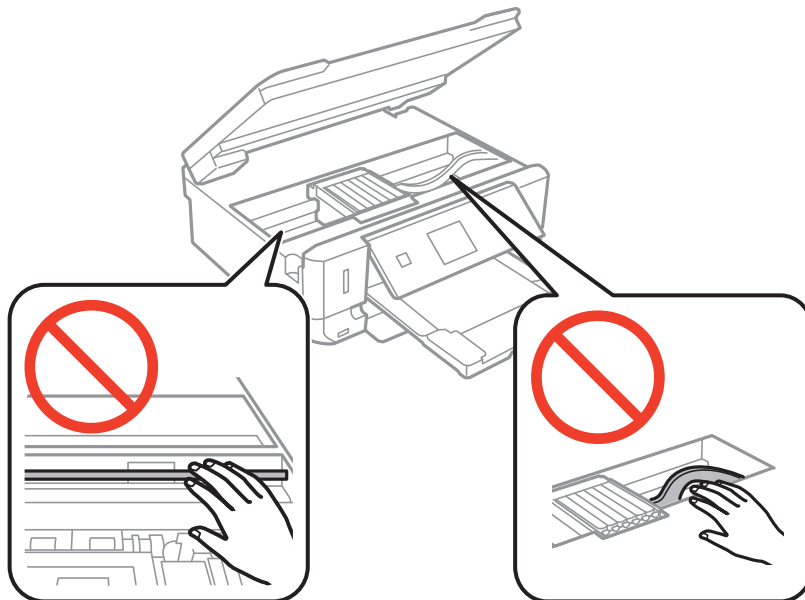

3. Close the scanner unit.

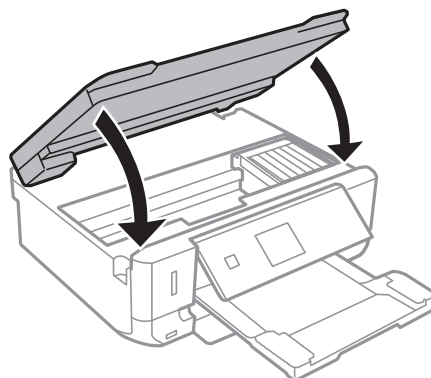

## Solving Problems

### Removing Jammed Paper from the Rear Cover

1. Remove the rear cover.

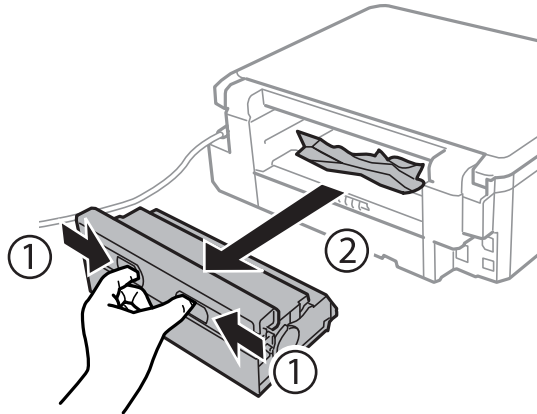

2. Remove the jammed paper.

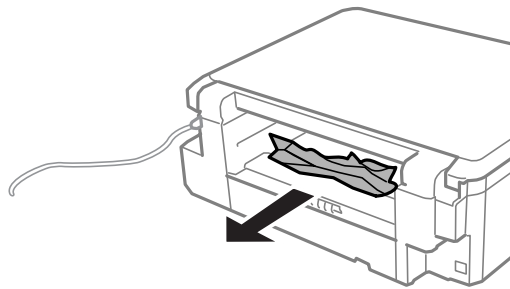

3. Remove jammed paper from the rear cover.

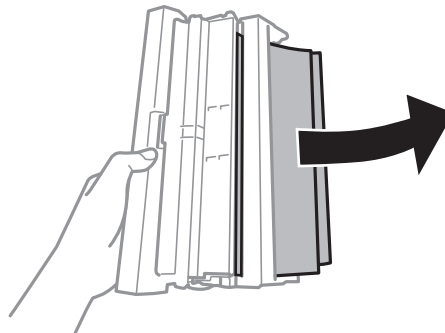

## Solving Problems

4. Open the cover of the rear cover.

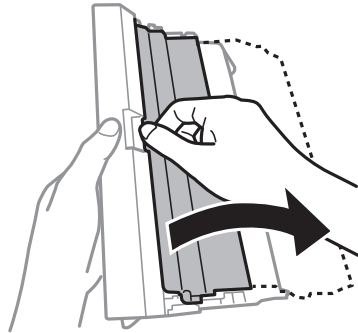

5. Remove the jammed paper.

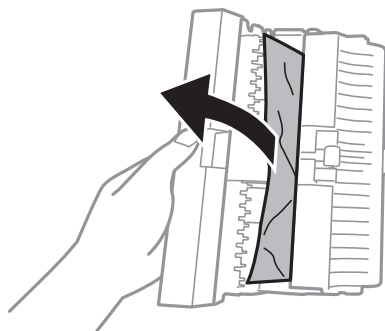

6. Close the cover of the rear cover, and then insert the rear cover in the printer.

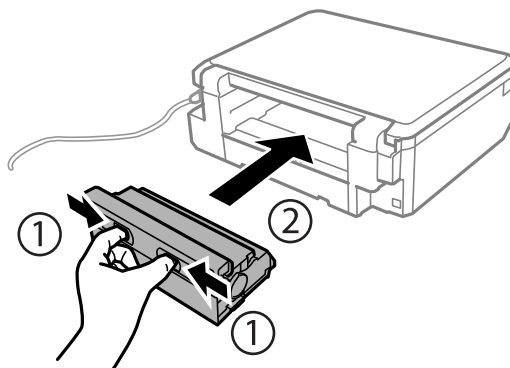

---

## Paper Does Not Feed Correctly

Check the following if the paper jams, paper is fed at a slant, several sheets of paper are fed at a time, no paper is fed, or paper is ejected.

- Place the printer on a flat surface and operate in the recommended environmental conditions.
- Use paper supported by this printer.
- Follow the paper handling precautions.
- Load paper in the correct direction, and slide the edge guides against the edges of the paper.
- Do not load more than the maximum number of sheets specified for the paper. For plain paper, do not load above the line indicated by the triangle symbol on the edge guide.

## Solving Problems

- Load one sheet of paper at a time when loading multiple sheets of paper.
- When several sheets of paper are fed at a time during manual 2-sided printing, remove any paper which is loaded in the paper source before you reload the paper.
- Load and eject paper without printing to clean the paper path.
- Make sure the paper size and paper type settings are correct.

### Related Information

- ➔ [“Environmental Specifications” on page 125](#)
- ➔ [“Paper Handling Precautions” on page 24](#)
- ➔ [“Available Paper and Capacities” on page 25](#)
- ➔ [“Loading Paper in the Paper Cassette” on page 27](#)
- ➔ [“Cleaning the Paper Path” on page 87](#)

---

## Power and Control Panel Problems

### Power Does Not Turn On

- Hold down the  button for a little longer.
- Make sure the power cord is securely plugged in.

### Lights Came On and then Went Out



The printer's voltage may not match the outlet rating. Turn off the printer and unplug it immediately. Then check the label on the printer.



**Caution:**

*If the voltage does not match, DO NOT PLUG YOUR PRINTER BACK IN. Contact your dealer.*

### Power Does Not Turn Off

Hold down the  button for a little longer. If you still cannot turn off the printer, unplug the power cord. To prevent the print head from drying out, turn the printer back on and turn it off by pressing the  button.

### LCD Screen Gets Dark

The printer is in sleep mode. Press any button on the control panel to return the LCD screen to its former state.

---

## Printer Does Not Print

Check the following if the printer does not operate or prints nothing.

- Install the printer driver.

## Solving Problems

- To print photos easily, install Epson Easy Photo Print.
- Connect the interface cable securely to the printer and the computer.
- If you are using a USB hub, try to connect the printer directly to the computer.
- If you are using the printer over a network, make sure the printer is connected to the network. You can check the status by checking the indicators on the control panel or by printing the network status sheet. If the printer is not connected to the network, see the *Network Guide*.
- If you are printing a large image, the computer may not have enough memory. Print the image at a lower resolution or a smaller size.
- In Windows, click **Print Queue** on the printer driver's **Maintenance** tab, and then check the following.
  - Check if there are any paused print jobs.  
Cancel printing if necessary.
  - Make sure the printer is not offline or pending.  
If the printer is offline or pending, clear the offline or pending setting from the **Printer** menu.
  - Make sure the printer is selected as the default printer from the **Printer** menu (there should be a check mark on the menu item).  
If the printer is not selected as the default printer, set it as the default printer.
- In Mac OS X, make sure the printer status is not **Pause**.  
Select **System Preferences** from the  menu > **Printers & Scanners** (or **Print & Scan, Print & Fax**), and then double-click the printer. If the printer is **paused**, click **Resume** (or **Resume Printer**).
- Run the nozzle check, and then clean the print head if any of the print head nozzles are clogged.
- If you are using the printer through AirPrint, enable **Paper Configuration** in **Setup** mode. If this feature is disabled, you cannot use AirPrint.
- You may not be able to use the printer through AirPrint if the necessary protocols or settings have been disabled. Enable AirPrint using Web Config.

### Related Information

- ➔ [“Installing Applications” on page 100](#)
- ➔ [“Epson Easy Photo Print” on page 98](#)
- ➔ [“Canceling Printing” on page 62](#)
- ➔ [“Checking and Cleaning the Print Head” on page 84](#)
- ➔ [“Setup Mode” on page 21](#)
- ➔ [“Web Config” on page 89](#)

---

## Printout Problems

### Print Quality Is Poor

Check the following if the print quality is poor due to blurry prints, banding, missing colors, faded colors, misalignment, and mosaic-like patterns in the prints.

- Run the nozzle check and then clean the print head if any of the print head nozzles are clogged.
- Align the print head.

## Solving Problems

- Use paper supported by this printer.
- Do not print on paper that is damp, damaged, or too old.
- If the paper is curled or the envelope is puffed up, flatten it.
- When printing images or photos, print using high-resolution data. Images on websites are often low resolution although they look good enough on the display, and so print quality may decline.
- Select the appropriate paper type setting on the control panel or in the printer driver for the type of paper loaded in the printer.
- Print using a high quality setting on the control panel or in the printer driver.
- When images or photos are printed in unexpected colors, adjust the color and print. The automatic color correction feature uses the standard correction mode in **PhotoEnhance**. Try another correction mode in **PhotoEnhance** by selecting an option other than **Auto Correct** (or **Automatic**) as the **Scene Correction** (or **Scene Detection**) setting. If the problem continues, use any other color correction feature other than **PhotoEnhance**.
- Disable the bidirectional (or high speed) setting. When this setting is enabled, the print head prints while moving in both directions, and vertical lines may be misaligned. If you disable this feature, printing may slow down.
  - Control Panel
 

In the print settings for **Print Photos** mode, disable **Bidirectional**.
  - Windows
 

Clear **High Speed** on the printer driver's **More Options** tab.
  - Mac OS X
 

Select **System Preferences** from the  menu > **Printers & Scanners** (or **Print & Scan**, **Print & Fax**), and then select the printer. Click **Options & Supplies** > **Options** (or **Driver**). Select **Off** as the **High Speed Printing** setting.
- Do not stack the paper immediately after printing.
- Dry the printouts completely before filing or displaying them. When drying the printouts, avoid direct sun light, do not use a dryer, and do not touch the printed side of paper.
- Try to use genuine Epson ink cartridges. This product is designed to adjust colors based on the use of genuine Epson ink cartridges. The use of non-genuine ink cartridges may cause print quality to decline.
- Epson recommends using the ink cartridge before the date printed on the package.
- For best results, use up ink cartridge within six months of opening the package.
- When printing images or photos, Epson recommends using genuine Epson paper rather than plain paper. Print on the printable side of the genuine Epson paper.

### Related Information

- ➔ [“Checking and Cleaning the Print Head” on page 84](#)
- ➔ [“Aligning the Print Head” on page 86](#)
- ➔ [“Paper Handling Precautions” on page 24](#)
- ➔ [“Available Paper and Capacities” on page 25](#)
- ➔ [“List of Paper Types” on page 26](#)
- ➔ [“Adjusting the Print Color” on page 57](#)
- ➔ [“Print Photos Mode” on page 19](#)

## Solving Problems

### Copy Quality Is Poor

Check the following if uneven colors, smears, dots, or straight lines appear in the copied image.

- Load and eject paper without printing to clean the paper path.
- Clean the scanner glass and the document cover.
- Do not press too hard on the original or the document cover when you are placing the originals on the scanner glass. Uneven colors, smears, or dots may appear when the original or the document cover are pressed too hard.
- If banding appears at intervals of 2.5 cm, align the print head.
- If a moire (cross-hatch) pattern appears, change the reduce and enlarge setting or place the original at a slightly different angle.

#### Related Information

- ➔ [“Cleaning the Paper Path” on page 87](#)
- ➔ [“Cleaning the Scanner Glass” on page 87](#)
- ➔ [“Aligning the Print Head” on page 86](#)
- ➔ [“Print Quality Is Poor” on page 110](#)

### An Image of the Reverse Side of the Original Appears in the Copied Image

- For a thin original, place the original on the scanner glass and then place a piece of black paper over it.
- Lower the copy density setting on the control panel.

### The Position, Size, or Margins of the Printout Are Incorrect

- Load paper in the correct direction, and slide the edge guides against the edges of the paper.
- When printing on photo stickers, enter **Setup**, select **Printer Setup - Stickers**, and then adjust the printing position.
- When placing the originals on the scanner glass, align the corner of the original with the corner indicated by a symbol on the frame of the scanner glass. If the edges of the copy are cropped off, move the original slightly away from the corner.
- When you place multiple originals on the scanner glass to copy them separately, but they are copied onto a single sheet, place the originals at least 5mm (0.2 inch) apart. If the problem continues, place one original at a time.
- Clean the scanner glass and the document cover. If there is dust or stains on the glass, the copy area may extend to include the dust or stains, resulting in the wrong printing position or small images.
- Select the appropriate paper size setting on the control panel or in the printer driver.
- Adjust the margin setting in the application so that it falls within the printable area.



## Solving Problems

- If you want to print with no margins, make settings for borderless printing.
  - Control Panel
 

In the print settings for **Print Photos** mode, select **Borderless**. If you select a paper type that does not support borderless printing, you cannot select **Borderless**. Select a paper type that supports borderless printing.
  - Windows
 

Select **Borderless** on the printer driver's **Main** tab. If you select a paper type that does not support borderless printing, you cannot select this check box. Select a paper type that supports borderless printing.
  - Mac OS X
 

Select a paper size for borderless printing as the **Paper Size** setting on the printer driver.
- During borderless printing, the image is slightly enlarged and the protruding area is cropped. Adjust the amount of enlargement.
  - Control Panel
 

In the print settings for **Print Photos** or **Copy** mode, select **Expansion**, and then select the amount of enlargement.
  - Windows
 

Click **Settings** on the printer driver's **Main** tab, and then select the amount of enlargement.
  - Mac OS X
 

Select the **Print Settings** menu on the printer driver and select the amount of enlargement on the **Expansion** setting.

### Related Information

- ➔ [“Loading Paper in the Paper Cassette” on page 27](#)
- ➔ [“Cleaning the Scanner Glass” on page 87](#)
- ➔ [“Printable Area” on page 121](#)
- ➔ [“Available Paper and Capacities” on page 25](#)
- ➔ [“Print Photos Mode” on page 19](#)
- ➔ [“Copy Mode” on page 17](#)

## Paper Is Smearred or Scuffed

Check the following if the paper is smeared or scuffed when printing.

- Clean the paper path.
- Clean the scanner glass and the document cover.
- Load paper in the correct direction.
- When performing manual 2-sided printing, make sure that the ink is completely dry before reloading the paper.
- When using the automatic 2-sided printing feature and printing high density data such as images and graphs, set the print density to lower and the drying time to longer.
- When the paper is smeared during copying, lower the copy density setting on the control panel.

### Related Information

- ➔ [“Cleaning the Paper Path” on page 87](#)

## Solving Problems

- ➔ [“Cleaning the Scanner Glass” on page 87](#)
- ➔ [“Loading Paper in the Paper Cassette” on page 27](#)
- ➔ [“Printing on 2-Sides” on page 45](#)
- ➔ [“Copy Mode” on page 17](#)
- ➔ [“Print Quality Is Poor” on page 110](#)

### Printed Characters Are Incorrect or Garbled

- Connect the interface cable securely to the printer and the computer.
- Cancel any paused print jobs.
- Do not put the computer manually into the **Hibernate** mode or the **Sleep** mode while printing. Pages of garbled text may be printed next time you start the computer.

#### Related Information

- ➔ [“Canceling Printing” on page 62](#)

### The Printed Image Is Inverted

Clear any mirror image settings in the printer driver or the application.

- Windows
  - Clear **Mirror Image** on the printer driver's **More Options** tab.
- Mac OS X
  - Clear **Mirror Image** from the print dialog's **Print Settings** menu.

### The Printout Problem Could Not be Cleared

If you have tried all of the solutions and have not solved the problem, try uninstalling and then reinstalling the printer driver.

#### Related Information



- ➔ [“Uninstalling Applications” on page 99](#)
- ➔ [“Installing Applications” on page 100](#)

---

## Printing Is Too Slow

- When printing continuously for approximately more than 10 minutes, printing slows down to prevent the printer mechanism from overheating and being damaged. However, you can continue printing. To return the printer to normal printing speed, cancel printing, and leave the printer idle for at least 30 minutes with the power on. The printer does not recover if the power is off.
- Close any unnecessary applications.
- Lower the quality setting on the control panel or the printer driver. High quality printing slows down the printing speed.

## Solving Problems

- ❑ Enable the bidirectional (or high speed) setting. When this setting is enabled, the print head prints while moving in both directions, and the printing speed increases.
  - ❑ Windows
    - Select **High Speed** on the printer driver's **More Options** tab.
  - ❑ Mac OS X
    - Select **System Preferences** from the  menu > **Printers & Scanners** (or **Print & Scan, Print & Fax**), and then select the printer. Click **Options & Supplies > Options** (or **Driver**). Select **On** as the **High Speed Printing** setting.
- ❑ Disable quiet mode. This feature slows down the printing speed.
  - ❑ Control Panel
    - From the home screen, select **Quiet Mode**, and then disable it.
  - ❑ Windows
    - Disable the **Quiet Mode** setting on the printer driver's **Main** tab.
  - ❑ Mac OS X
    - Select **System Preferences** from the  menu > **Printers & Scanners** (or **Print & Scan, Print & Fax**), and then select the printer. Click **Options & Supplies > Options** (or **Driver**). Select **Off** as the **Quiet Mode** setting.

---

## Cannot Start Scanning

- ❑ Connect the interface cable securely to the printer and the computer.
- ❑ If you are using a USB hub, try to connect the printer directly to the computer.
- ❑ When using the printer on a network, make sure the printer is connected to the network properly. You can check the connection status from the network icon on the printer window and by printing a network status sheet. If the printer is not connected to the network, see the *Network Guide*.
- ❑ Make sure you select the correct printer (scanner) if a scanner list is displayed when you start EPSON Scan.
- ❑ If you are using any TWAIN-compliant applications, select the printer (scanner) you are using.
- ❑ In Windows, make sure the printer (scanner) is displayed in **Scanner and Camera**. The printer (scanner) should be displayed as "EPSON XXXXX (printer name)". If the printer (scanner) is not displayed, uninstall and then re-install EPSON Scan. See the following to access **Scanner and Camera**.
  - ❑ Windows 8.1/Windows 8
    - Select **Desktop > Settings > Control Panel**, enter "Scanner and Camera" in the search charm, click **Show Scanner and Camera**, and then check if the printer is displayed.
  - ❑ Windows 7
    - Click the start button and select **Control Panel**, enter "Scanner and Camera" in the search charm, click **View scanners and cameras**, and then check if the printer is displayed.
  - ❑ Windows Vista
    - Click the start button, select **Control Panel > Hardware and Sound > Scanners and Cameras**, and then check if the printer is displayed.
  - ❑ Windows XP
    - Click the start button, select **Control Panel > Printers and Other Hardware > Scanner and Cameras**, and then check if the printer is displayed.

## Solving Problems

- ❑ If you cannot scan using any TWAIN-compliant applications, uninstall and then reinstall the TWAIN compliant application.
- ❑ For Mac OS X with an Intel processor, if other Epson scanner drivers except for EPSON Scan, such as Rosetta or PPC are installed, uninstall them and EPSON Scan, and then reinstall EPSON Scan.

### Related Information

- ➔ [“Uninstalling Applications” on page 99](#)
- ➔ [“Installing Applications” on page 100](#)

## Cannot Start Scanning when Using the Control Panel

- ❑ Make sure EPSON Scan and Epson Event Manager are installed correctly.
- ❑ Check the scanning setting assigned in Epson Event Manager.

### Related Information

- ➔ [“Cannot Start Scanning” on page 115](#)

---

## Scanned Image Problems

### Scan Quality Is Poor

- ❑ Clean the scanner glass and the document cover.
- ❑ Do not press too hard on the original or the document cover when you are placing the originals on the scanner glass. Uneven colors, smears, or dots may appear when the original or the document cover are pressed too hard.
- ❑ Remove dust from the original.
- ❑ Make the appropriate document type settings on the control panel.
- ❑ Scan at a higher resolution.
- ❑ Adjust the image in EPSON Scan, and then scan. See the EPSON Scan help for details.

### Related Information

- ➔ [“Cleaning the Scanner Glass” on page 87](#)
- ➔ [“Scan Mode” on page 20](#)

### Characters Are Blurred

- ❑ In **Home Mode** or **Office Mode** in EPSON Scan, select **Image Option** as the **Image Adjustments** setting, and then select **Text Enhancement**.
- ❑ In **Professional Mode** in EPSON Scan, select **Document** as the **Auto Exposure Type** in the **Original** settings.

## Solving Problems

- Adjust the threshold settings in EPSON Scan.
  - Home Mode**  
Select **Black & White** as the **Image Type** setting, click **Brightness**, and then adjust the threshold.
  - Office Mode**  
Select **Black & White** as the **Image Type** setting, and then adjust the threshold.
  - Professional Mode**  
Select **Black & White** as the **Image Type** setting, and then adjust the threshold setting.
- Scan at a higher resolution.

### An Image of the Reverse Side of the Original Appears in the Scanned Image

- For a thin original, place the original on the scanner glass and then place a piece of black paper over it.
- Make the appropriate document type settings on the control panel or in EPSON Scan.
- In **Home** or **Office Mode** in EPSON Scan, select **Image Option** as the **Image Adjustments** setting, and then select **Text Enhancement**.

#### Related Information

- ➔ [“Scan Mode” on page 20](#)

### Moire (Cross-Hatch) Patterns Appear in the Scanned Image

- Place the original at a slightly different angle.
- Select **Descreening** in any mode other than **Full Auto Mode** in EPSON Scan.
- Change the resolution setting on the control panel or in EPSON Scan.

#### Related Information

- ➔ [“Scan Mode” on page 20](#)

### Scanning Area or Direction Is Not Correct

- When placing the originals on the scanner glass, align the corner of the original with the corner indicated by a symbol on the frame of the scanner glass. If the edges of the scanned image are cropped off, move the original slightly away from the corner.
- Clean the scanner glass and the document cover. If there is dust or stains on the glass, the scanning area may extend to include the dust or stains, resulting in the wrong scanning position or small images.
- When you place multiple originals on the scanner glass to scan them separately, but they are scanned onto a single file, place the originals at least 20 mm (0.8 inch) apart. If the problem continues, place one original at a time.
- When scanning from the control panel, set the scan area correctly.
- When scanning using **Full Auto Mode** or the thumbnail preview in EPSON Scan, move the original 4.5 mm (0.18 inch) away from the edges of the scanner glass.

## Solving Problems

- ❑ When using the thumbnail preview for a large original in **Home Mode** or **Professional Mode** in EPSON Scan, the scanning area may not be correct. When previewing in EPSON Scan, create marquees of the area you want to scan on the **Preview** tab in the **Preview** window.
- ❑ If **Auto Photo Orientation** in EPSON Scan does not work as intended, see the EPSON Scan help.
- ❑ Clear **Auto Photo Orientation** in EPSON Scan.
- ❑ When scanning with EPSON Scan the available scanning area may be restricted if the resolution setting is too high. Lower the resolution or adjust the scanning area in the **Preview** window.

### Related Information

- ➔ [“Placing Originals on the Scanner Glass” on page 32](#)
- ➔ [“Cleaning the Scanner Glass” on page 87](#)
- ➔ [“Scan Mode” on page 20](#)

## The Scanned Image Problem Could Not be Cleared

If you have tried all of the solutions and could not solve the problem, click **Configuration** in a mode other than **Full Auto Mode** in the EPSON Scan window, and then click **Reset All** on the **Other** tab to initialize the EPSON Scan settings. If initialization does not solve the problem uninstall and re-install EPSON Scan.

### Related Information

- ➔ [“Uninstalling Applications” on page 99](#)
- ➔ [“Installing Applications” on page 100](#)

---

## Other Scanning Problems

### Cannot Scan in Full Auto Mode in EPSON Scan

- ❑ You cannot scan to PDF/Multi-TIFF format continuously in **Full Auto Mode**. Scan in a mode other than **Full Auto Mode**.
- ❑ See the EPSON Scan help for other way of solving problems.

### Thumbnail Preview Does Not Work Properly

See the EPSON Scan help.

### Scanning Is Too Slow

- ❑ Lower the resolution.
- ❑ Disable quiet mode.
  - ❑ Control Panel  
From the home screen, select **Quiet Mode**, and then disable it.
  - ❑ EPSON Scan  
Click **Configuration**, and then disable **Quiet Mode** on the **Other** tab.

**Related Information**

➔ [“Scan Mode” on page 20](#)

## Scanning Stops when Scanning to PDF/Multi-TIFF

- When scanning large volumes, we recommend scanning in grayscale.
- Increase the free space on the computer's hard disk. Scanning may stop if there is not enough free space.
- Try scanning at a lower resolution. Scanning stops if the total data size reaches the limit.

**Related Information**

➔ [“Scan Mode” on page 20](#)

---

## Other Problems

### Slight Electric Shock when Touching the Printer

If many peripherals are connected to the computer, you may feel a slight electric shock when touching the printer. Install a ground wire to the computer that is connected to the printer.

### Operation Sounds Are Loud

If operations sounds are too loud, enable quiet mode. However, this may slow down printer operations.

- Control Panel
  - From the home screen, select **Quiet Mode**, and then enable it.
- Windows
  - Enable **Quiet Mode** on the **Main** tab in the printer driver.
- Mac OS X
  - Select **System Preferences** from the  menu > **Printers & Scanners** (or **Print & Scan**, **Print & Fax**), and then select the printer. Click **Options & Supplies** > **Options** (or **Driver**). Select **On** as the **Quiet Mode** setting.
- EPSON Scan
  - Select a mode other than **Full Auto Mode**, click **Configuration**, and then set **Quiet Mode** on the **Other** tab.

### Cannot Save the Data to a Memory Card

- Use a memory card which is supported by the printer.
- Check that the memory card is not write protected.
- Check that the memory card has enough available memory. If the available memory is low, data cannot be saved.

**Related Information**

➔ [“Supported Memory Card Specifications” on page 123](#)

## **Application Is Blocked by a Firewall (for Windows Only)**

Add the application to the Windows Firewall allowed program in security settings on the **Control Panel**.

## **"?" Is Displayed on the Photo Selection Screen**

"?" is displayed on the LCD screen when the image file is not supported by the product.

### **Related Information**

➔ [“Supported Data Specifications” on page 124](#)



# Appendix

## Technical Specifications

### Printer Specifications

|                             |             |   |
|-----------------------------|-------------|---|
| Print Head Nozzle Placement |             | Black ink nozzles: 180<br>Photo black ink nozzles: 180<br>Color ink nozzles: 180 for each color |
| Weight of Paper             | Plain Paper | 64 to 90 g/m <sup>2</sup> (17 to 24lb)  |
|                             | Envelopes   | Envelope #10, DL, C6: 75 to 90 g/m <sup>2</sup> (20 to 24 lb)                                   |

### Printable Area

Print quality may decline in the shaded areas due to the printer's mechanism.

#### Single sheets (normal printing)

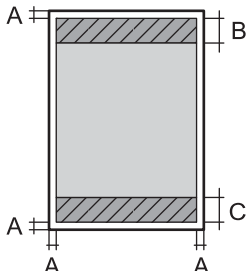
|   |   |                    |
|---|---|--------------------|
|  | A | 3.0 mm (0.12 in.)  |
|   | B | 41.0 mm (1.61 in.) |
|   | C | 37.0 mm (1.46 in.) |

#### Single sheets (borderless printing)

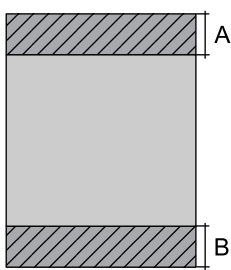
|   |   |                    |
|---|---|--------------------|
|  | A | 44.0 mm (1.73 in.) |
|   | B | 40.0 mm (1.57 in.) |

## Appendix

### Envelopes

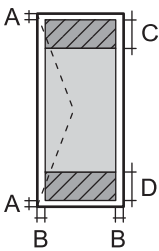
|   |   |                    |
|---|---|--------------------|
|  | A | 3.0 mm (0.12 in.)  |
|   | B | 5.0 mm (0.20 in.)  |
|   | C | 18.0 mm (0.71 in.) |
|   | D | 41.0 mm (1.61 in.) |

### Scanner Specifications

|                       |  |
|-----------------------|--|
| Scanner Type          | Flatbed  |
| Photoelectric Device  | CIS  |
| Maximum Document Size | 216 × 297 mm (8.5 × 11.7 in.)<br>A4, Letter  |
| Resolution            | 1200 dpi (main scan)<br>2400 dpi (sub scan)  |
| Color Depth           | <p>Color</p> <ul style="list-style-type: none"> <li><input type="checkbox"/> 48 bits per pixel internal (16 bits per pixel per color internal)</li> <li><input type="checkbox"/> 24 bits per pixel external (8 bits per pixel per color external)</li> </ul> <p>Grayscale</p> <ul style="list-style-type: none"> <li><input type="checkbox"/> 16 bits per pixel internal</li> <li><input type="checkbox"/> 8 bits per pixel external</li> </ul> <p>Black and white</p> <ul style="list-style-type: none"> <li><input type="checkbox"/> 16 bits per pixel internal</li> <li><input type="checkbox"/> 1 bits per pixel external</li> </ul> |
| Light Source          | LED  |

### Interface Specifications

|              |              |
|--------------|--------------|
| For Computer | Hi-Speed USB |
|--------------|--------------|

### Wi-Fi Specifications

|                     |   |
|---------------------|---|
| Standards           | IEEE802.11b/g/n   |
| Frequency Range     | 2.4 GHz   |
| Coordination Modes  | Infrastructure, Ad hoc <sup>*1</sup> , Wi-Fi Direct <sup>*2*3</sup> |
| Wireless Securities | WEP (64/128bit), WPA2-PSK (AES) <sup>*4</sup>                       |

## Appendix

- \*1 Not supported for IEEE 802.11n.
- \*2 Not supported for IEEE 802.11b.
- \*3 Simple AP mode is compatible with Wi-Fi connection (infrastructure).
- \*4 Complies with WPA2 standards with support for WPA/WPA2 Personal.

## Security Protocol

|         |                           |
|---------|---------------------------|
| SSL/TLS | HTTPS Server/Client, IPPS |
|---------|---------------------------|

## Supported Third Party Services

|                    |       |  |
|--------------------|-------|--|
| AirPrint           | Print | iOS 5 or later/Mac OS X v10.7.x or later |
|                    | Scan  | Mac OS X v10.9.x or later                |
| Google Cloud Print |       |  |

## External Storage Device Specifications

### Supported Memory Card Specifications

| Compatible Memory Cards | Maximum Capacities |
|-------------------------|--------------------|
| miniSD*                 | 2 GB               |
| miniSDHC*               | 32 GB              |
| microSD*                | 2 GB               |
| microSDHC*              | 32 GB              |
| microSDXC*              | 64 GB              |
| SD                      | 2 GB               |
| SDHC                    | 32 GB              |
| SDXC                    | 64 GB              |

\* Attach an adapter to fit the memory card slot. Otherwise, the card may get stuck.

### Supported memory card voltages

3.3 V type, dual voltage (3.3 V and 5V) type (supply voltage: 3.3 V)

5 V memory cards are not supported.

Maximum supply current: 200 mA

## Appendix

### Supported Data Specifications

|                         |   |
|-------------------------|---|
| File Format             | JPEG with the Exif Version 2.3 standard taken by digital cameras DCF* <sup>1</sup> version 1.0 or 2.0* <sup>2</sup> compliant |
| Image Size              | Horizontal: 80 to 10200 pixels<br>Vertical: 80 to 10200 pixels  |
| File Size               | Up to 2 GB  |
| Maximum Number of Files | 9990* <sup>3</sup>  |

\*1 Design rule for Camera File system.

\*2 Photo data stored in the built-in memory of a digital camera is not supported.

\*3 Up to 999 files can be displayed at a time. (If the number of files exceeds 999, the files are displayed in groups.)

**Note:**

"?" is displayed on the LCD screen when the printer cannot recognize the image file. In this situation, if you select a multiple image layout, blank sections will be printed.

### Dimensions

|                      |   |
|----------------------|---|
| Dimensions           | <p>Storage (Without protruding parts)</p> <ul style="list-style-type: none"> <li><input type="checkbox"/> Width: 390 mm (15.4 in.)</li> <li><input type="checkbox"/> Depth: 338 mm (13.3 in.)</li> <li><input type="checkbox"/> Height: 138 mm (5.4 in.)</li> </ul> <p>Storage (Including protruding parts*<sup>1</sup>)</p> <ul style="list-style-type: none"> <li><input type="checkbox"/> Width: 390 mm (15.4 inches)</li> <li><input type="checkbox"/> Depth: 341 mm (13.4 inches)</li> <li><input type="checkbox"/> Height: 138 mm (5.4 inches)</li> </ul> <p>Printing</p> <ul style="list-style-type: none"> <li><input type="checkbox"/> Width: 390 mm (15.4 in.)</li> <li><input type="checkbox"/> Depth: 504 mm (19.8 in.)</li> <li><input type="checkbox"/> Height: 138 mm (5.4 in.)</li> </ul> |
| Weight* <sup>2</sup> | Approx. 6.2 kg (13.7 lb)  |

\*1 See the following illustration for details.

\*2 Without the ink cartridges and the power cord.

Appendix

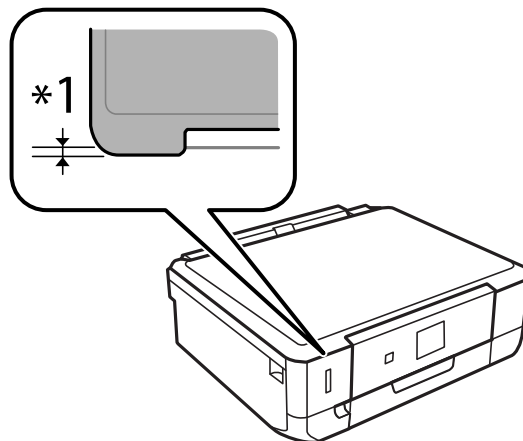

Electrical Specifications

| Model                                   | 100 to 120 V Model  | 220 to 240 V Model  |
|---|---|---|
| Rated Frequency Range                   | 50 to 60 Hz   | 50 to 60 Hz   |
| Rated Current                           | 0.7 A   | 0.35 A  |
| Power Consumption (with USB Connection) | Standalone copying: Approx. 19 W (ISO/IEC24712)<br>Ready mode: Approx. 4.7 W<br>Sleep mode: Approx. 1.0 W<br>Power off: Approx. 0.2 W | Standalone copying: Approx. 19 W (ISO/IEC24712)<br>Ready mode: Approx. 4.7 W<br>Sleep mode: Approx. 1.0 W<br>Power off: Approx. 0.4 W |

**Note:**  
Check the label on the printer for its voltage.

Environmental Specifications

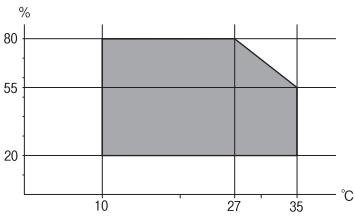
|           |   |
|-----------|---|
| Operation | Use the printer within the range shown in the following graph.<br><br>Temperature: 10 to 35°C (50 to 95°F)<br>Humidity: 20 to 80% RH (without condensation) |
| Storage   | Temperature: -20 to 40°C (-4 to 104°F)*<br>Humidity: 5 to 85% RH (without condensation)   |

\* You can store for one month at 40°C (104°F).

## Environmental Specifications for Ink Cartridges

|                      |  |
|----------------------|--|
| Storage Temperature  | -20 to 40 °C (-4 to 104 °F)*   |
| Freezing Temperature | -16 °C (3.2 °F)<br>Ink thaws and is usable after approximately 3 hours at 25 °C (77 °F). |

\* You can store for one month at 40 °C (104 °F).

## System Requirements

- Windows 8.1 (32-bit, 64-bit)/Windows 8 (32-bit, 64-bit)/Windows 7 (32-bit, 64-bit)/Windows Vista (32-bit, 64-bit)/Windows XP Professional x64 Edition/Windows XP (32-bit)
- Mac OS X v10.9.x/Mac OS X v10.8.x/Mac OS X v10.7.x/Mac OS X v10.6.8

**Note:**

- Mac OS X may not support some applications and features.
- The UNIX File System (UFS) for Mac OS X is not supported.

---

## Regulatory Information

### Standards and Approvals

#### Standards and Approvals for U.S. Model

|        |   |
|--------|---|
| Safety | UL60950-1<br>CAN/CSA-C22.2 No.60950-1                             |
| EMC    | FCC Part 15 Subpart B Class B<br>CAN/CSA-CEI/IEC CISPR 22 Class B |

This equipment contains the following wireless module.

Manufacturer: Askey Computer Corporation

Type: WLU6320-D69 (RoHS)

This product conforms to Part 15 of the FCC Rules and RSS-210 of the IC Rules. Epson cannot accept responsibility for any failure to satisfy the protection requirements resulting from a non-recommended modification of the product. Operation is subject to the following two conditions: (1) this device may not cause harmful interference, and (2) this device must accept any interference received, including interference that may cause undesired operation of the device.

To prevent radio interference to the licensed service, this device is intended to be operated indoors and away from windows to provide maximum shielding. Equipment (or its transmit antenna) that is installed outdoors is subject to licensing.

## Appendix

### Standards and Approvals for European Model

|                                  |  |
|----------------------------------|--|
| Low voltage directive 2006/95/EC | EN60950-1  |
| EMC directive 2004/108/EC        | EN55022 Class B<br>EN61000-3-2<br>EN61000-3-3<br>EN55024 |
| R&TTE directive 1999/5/EC        | EN300 328<br>EN301 489-1<br>EN301 489-17<br>EN60950-1    |

For European users

We, Seiko Epson Corporation, hereby declare that the following equipment Models are in compliance with the essential requirements and other relevant provisions of Directive 1999/5/EC:

C491K

For use only in Ireland, UK, Austria, Germany, Liechtenstein, Switzerland, France, Belgium, Luxemburg, Netherlands, Italy, Portugal, Spain, Denmark, Finland, Norway, Sweden, Iceland, Croatia, Cyprus, Greece, Slovenia, Malta, Bulgaria, Czech, Estonia, Hungary, Latvia, Lithuania, Poland, Romania, and Slovakia.

Epson cannot accept responsibility for any failure to satisfy the protection requirements resulting from a non-recommended modification of the products.



### Standards and Approvals for Australian Model

|     |                        |
|-----|------------------------|
| EMC | AS/NZS CISPR22 Class B |
|-----|------------------------|

Epson hereby declares that the following equipment Models are in compliance with the essential requirements and other relevant provisions of AS/NZS4268:

C491K

Epson cannot accept responsibility for any failure to satisfy the protection requirements resulting from a non-recommended modification of the products.

### Restrictions on Copying

Observe the following restrictions to ensure the responsible and legal use of the printer.

Copying of the following items is prohibited by law:

- Bank bills, coins, government-issued marketable securities, government bond securities, and municipal securities
- Unused postage stamps, pre-stamped postcards, and other official postal items bearing valid postage
- Government-issued revenue stamps, and securities issued according to legal procedure

## Appendix

Exercise caution when copying the following items:

- Private marketable securities (stock certificates, negotiable notes, checks, etc.), monthly passes, concession tickets, etc.
- Passports, driver's licenses, warrants of fitness, road passes, food stamps, tickets, etc.

**Note:**

*Copying these items may also be prohibited by law.*

Responsible use of copyrighted materials:

Printers can be misused by improperly copying copyrighted materials. Unless acting on the advice of a knowledgeable attorney, be responsible and respectful by obtaining the permission of the copyright holder before copying published material.

---

## Transporting the Printer

When you need to transport the printer to move or for repairs, follow the steps below to pack the printer.



**Caution:**

*Be careful not to trap your hand or fingers when opening or closing the scanner unit. Otherwise you may be injured.*



**Important:**

- When storing or transporting the printer, avoid tilting it, placing it vertically, or turning it upside down; otherwise ink may leak.*
- Leave the ink cartridges installed. Removing the cartridges can dry out the print head and may prevent the printer from printing.*

1. Turn off the printer by pressing the  button.
2. Make sure the power light turns off, and then unplug the power cord.



**Important:**

*Unplug the power cord when the power light is off. Otherwise, the print head may not return to the home position causing the ink to dry, and printing may become impossible.*

3. Disconnect all cables such as the power cord and USB cable.
4. Make sure there is no memory card inserted.
5. Remove all of the paper from the printer.
6. Make sure there are no originals on the printer.



**Appendix**

7. Open the scanner unit with the document cover closed. Secure the ink cartridge holder to the case with tape.

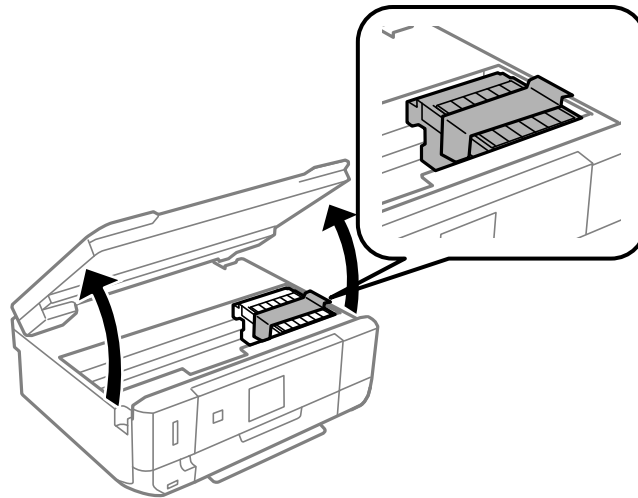

8. Close the scanner unit.
9. Prepare to pack the printer as shown below.

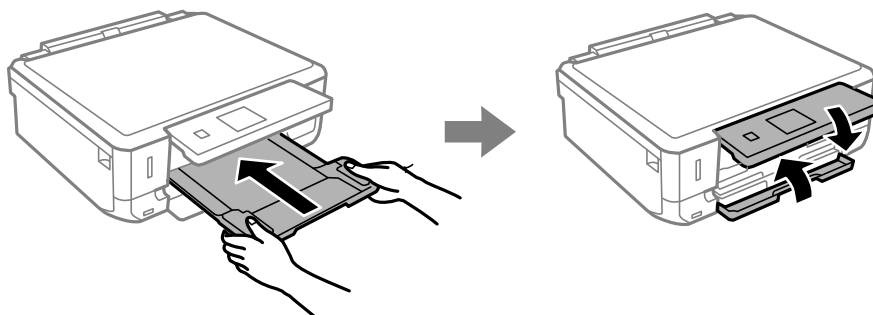

10. Pack the printer in its box, using the protective materials.

When you use the printer again, make sure you remove the tape securing the ink cartridge holder. If print quality has declined the next time you print, clean and align the print head.

**Related Information**

- ➔ [“Part Names and Functions” on page 13](#)
- ➔ [“Checking and Cleaning the Print Head” on page 84](#)
- ➔ [“Aligning the Print Head” on page 86](#)

---

## Accessing a Memory Card From a Computer

You can write or read data on an external storage device such as a memory card that has been inserted in the printer from a computer.

## Appendix

**!** **Important:**

- ❑ Insert a memory card after removing write protection.
- ❑ If an image is saved to the memory card from a computer, the image and the number of photos are not refreshed on the LCD screen. Remove and insert the memory card again.
- ❑ When sharing an external device inserted in the printer between computers connected over USB and over a network, write access is only allowed to the computers that are connected by the method you selected on the printer. To write to the external storage device, enter **Setup** on the control panel and select **File Sharing Setup** and a connection method. Data can be read by computers connected over USB and over a network.
- ❑ To write to the external storage device connected to the computer over a network, enter **Setup** on the control panel and select **File Sharing Setup**, and then give a priority to a network connection.

**Note:**

It takes a while to recognize data from a computer if a large external storage device, such as 2TB HDD, is connected.

**Windows**

Select an external storage device in **Computer** or **My Computer**. The data on the external storage device is displayed.

**Note:**

If you connected the printer to the network without the software disk or Web Installer, map a memory card slot or USB port as a network drive. Open **Run** and enter a printer name `\\EPSONXXXXX` or a printer's IP address `\\XXX.XXX.XXX.XXX` to **Open**. Right-click a device icon displayed to assign the network. The network drive appears in **Computer** or **My Computer**.

**Mac OS X**

Select a corresponding device icon. The data on the external storage device is displayed.

**Note:**

- ❑ To remove an external storage device, drag the device icon to the trash icon. Otherwise, data in the shared drive may not be displayed correctly when another external storage device is inserted.
- ❑ If you connected the printer to the network without EpsonNet Setup, map a memory card slot or USB port as a network drive. Select **Go > Connect to Server**. Enter a printer name `cifs://EPSONXXXXX` or `smb://EPSONXXXXX` in the **Server Address** and click **Connect**.

**Related Information**

- ➔ [“Inserting a Memory Card” on page 35](#)
- ➔ [“Setup Mode” on page 21](#)
- ➔ [“Supported Memory Card Specifications” on page 123](#)

---

## Where to Get Help

### Technical Support Web Site

If you need further help, visit the Epson support website shown below. Select your country or region and go to the support section of your local Epson website. The latest drivers, FAQs, manuals, or other downloadables are also available from the site.

<http://support.epson.net/>

## Appendix

<http://www.epson.eu/Support> (Europe)

If your Epson product is not operating properly and you cannot solve the problem, contact Epson support services for assistance.

## Contacting Epson Support

### Before Contacting Epson

If your Epson product is not operating properly and you cannot solve the problem using the troubleshooting information in your product manuals, contact Epson support services for assistance. If Epson support for your area is not listed below, contact the dealer where you purchased your product.

Epson support will be able to help you much more quickly if you give them the following information:

- Product serial number  
(The serial number label is usually on the back of the product.)
- Product model
- Product software version  
(Click **About**, **Version Info**, or a similar button in the product software.)
- Brand and model of your computer
- Your computer operating system name and version
- Names and versions of the software applications you normally use with your product

**Note:**

*Depending on the product, the dial list data for fax and/or network settings may be stored in the product's memory. Due to breakdown or repair of a product, data and/or settings may be lost. Epson shall not be responsible for the loss of any data, for backing up or recovering data and/or settings even during a warranty period. We recommend that you make your own backup data or take notes.*

### Help for Users in Europe

Check your Pan-European Warranty Document for information on how to contact Epson support.

### Help for Users in Australia

Epson Australia wishes to provide you with a high level of customer service. In addition to your product manuals, we provide the following sources for obtaining information:

#### Internet URL

<http://www.epson.com.au>

Access the Epson Australia World Wide Web pages. Worth taking your modem here for the occasional surf! The site provides a download area for drivers, Epson contact points, new product information and technical support (e-mail).

#### Epson Helpdesk

Epson Helpdesk is provided as a final backup to make sure our clients have access to advice. Operators on the Helpdesk can aid you in installing, configuring and operating your Epson product. Our Pre-sales Helpdesk staff can provide literature on new Epson products and advise where the nearest dealer or service agent is located. Many types of queries are answered here.

## Appendix

The Helpdesk numbers are:

Phone: 1300 361 054

We encourage you to have all the relevant information on hand when you ring. The more information you prepare, the faster we can help solve the problem. This information includes your Epson product manuals, type of computer, operating system, application programs, and any information you feel is required.