

# Start Here

## 1. Unpacking

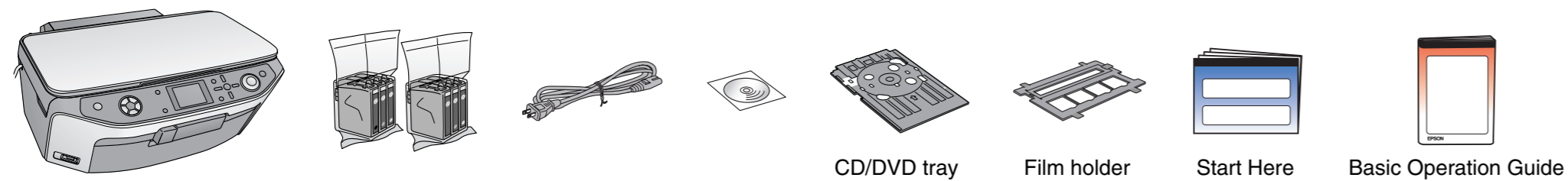

## 2. Removing Protective Tape

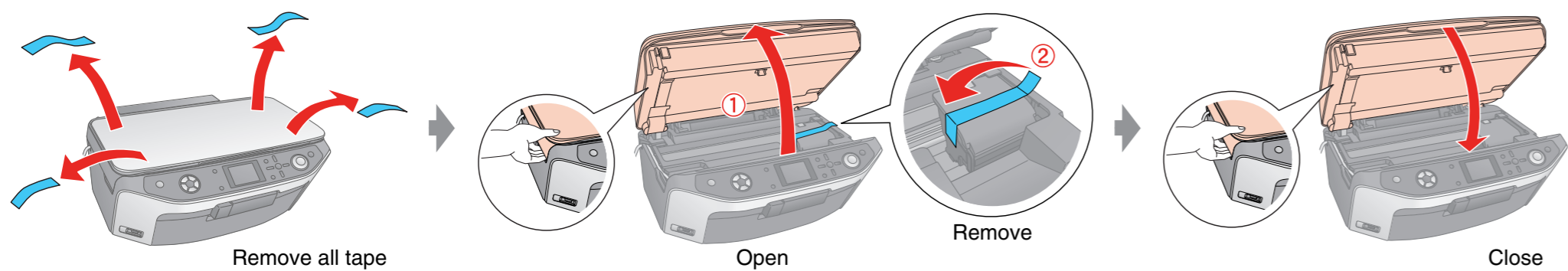

## 3. Unlocking and Turning On

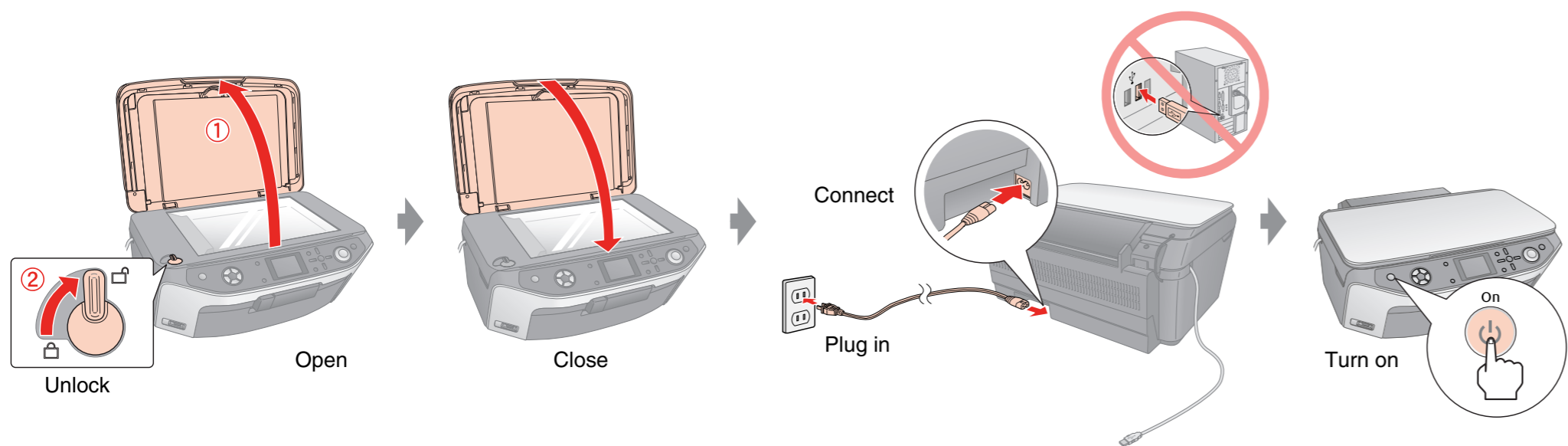

## 4. Selecting a Language

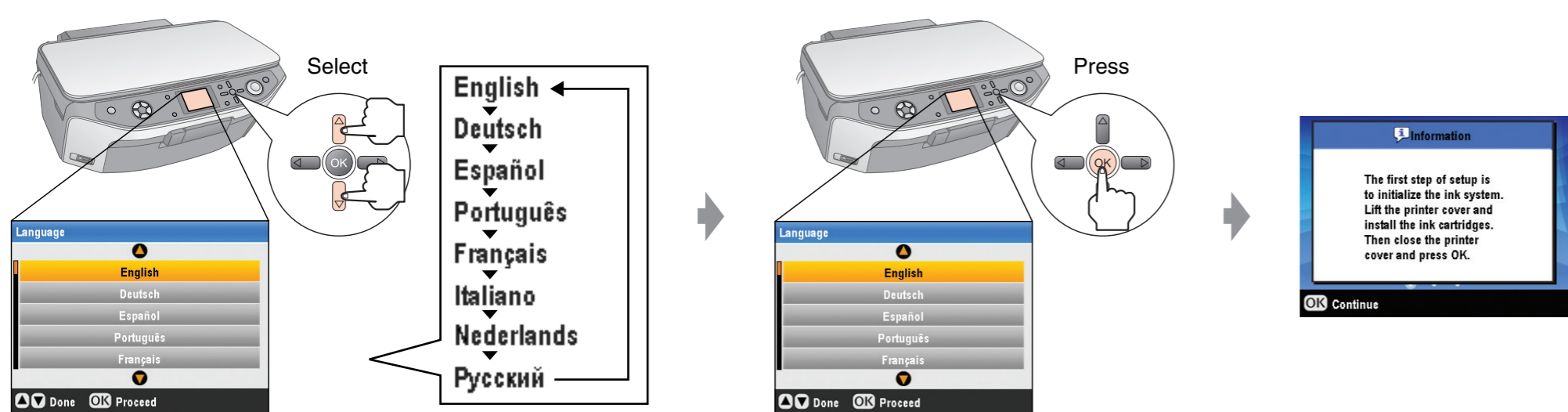

## 5. Installing Ink Cartridges

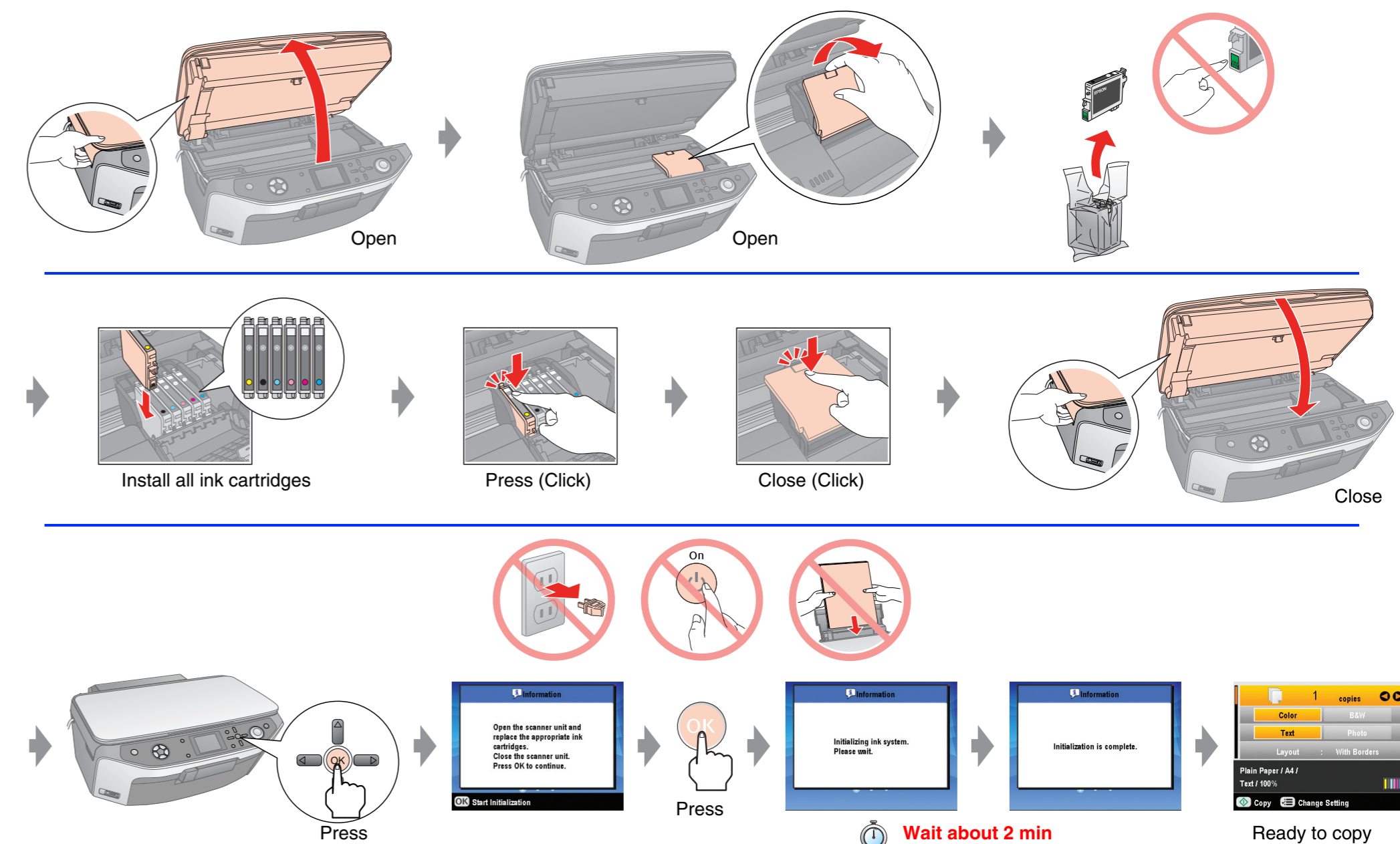

**Note:**  
The ink cartridges first installed in your EPSON STYLUS PHOTO RX will be partly used to charge the print head. Subsequent ink cartridges will last for their full rated life.

## 6. Installing the Software

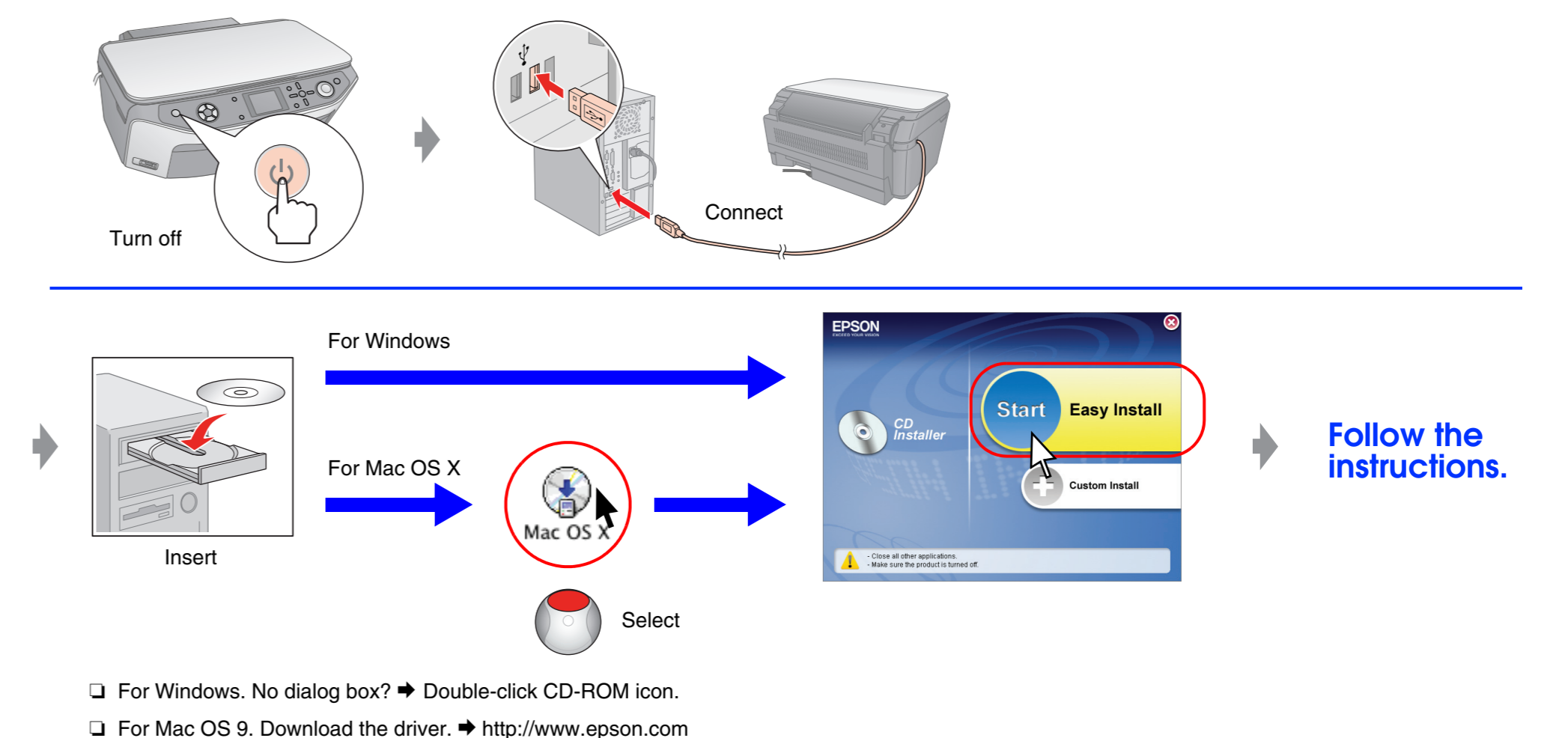

# Making Copies

## 1. Loading Paper

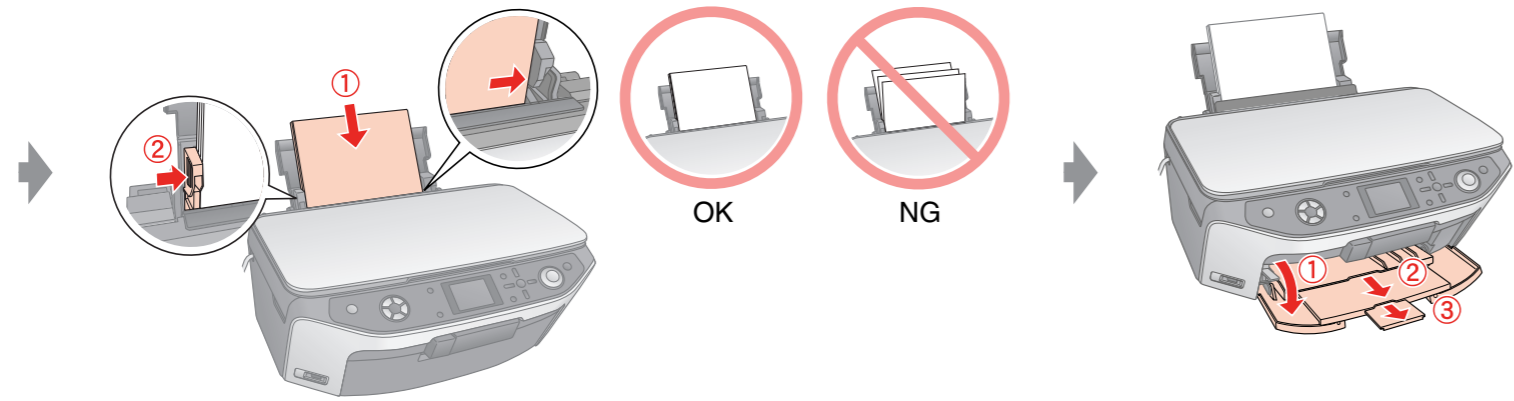
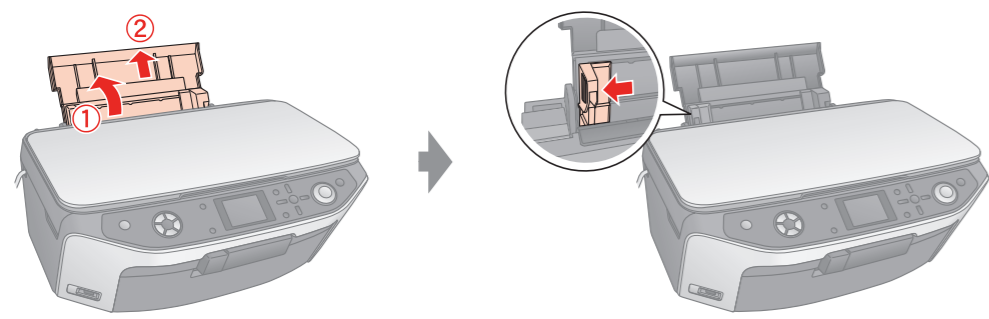

## 2. Copying

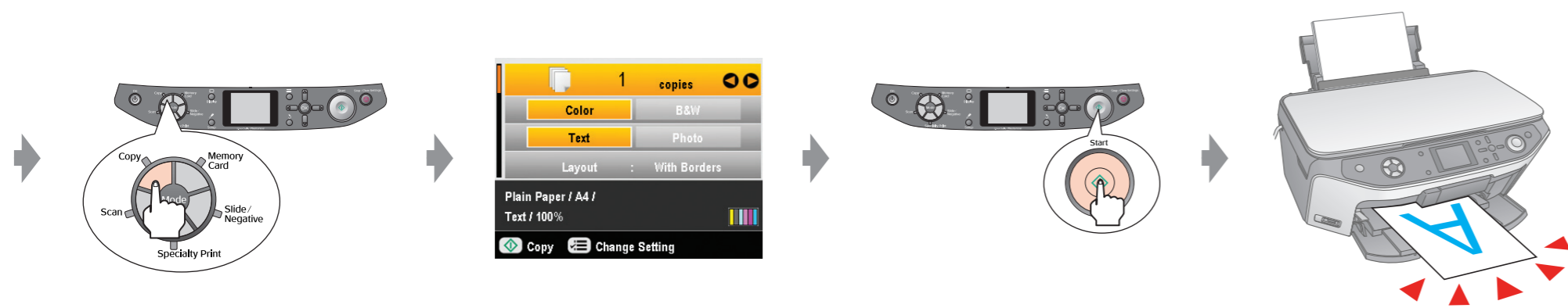
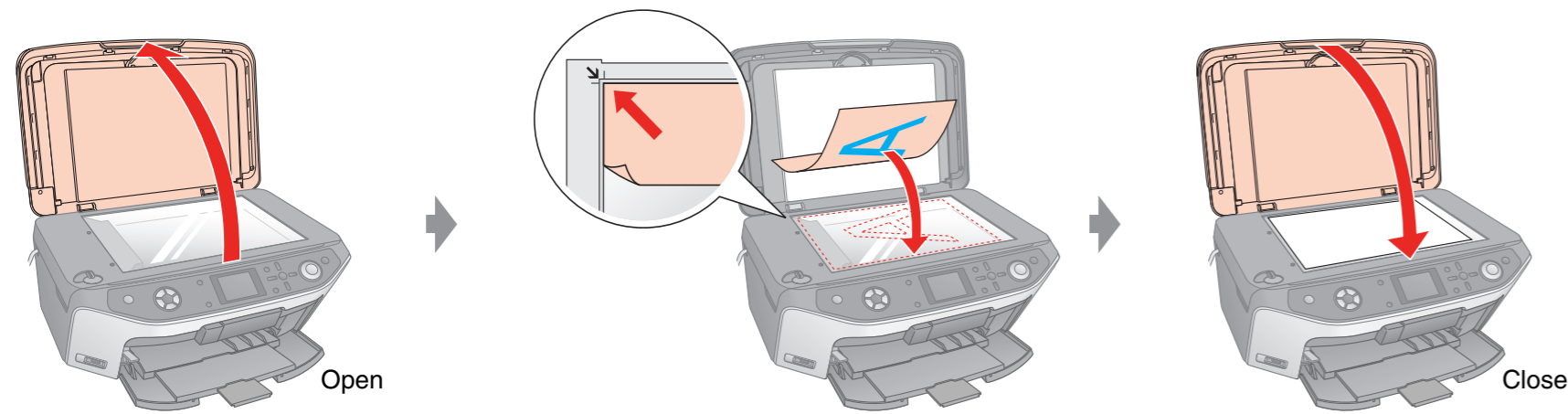

# Troubleshooting

## Does not turn on

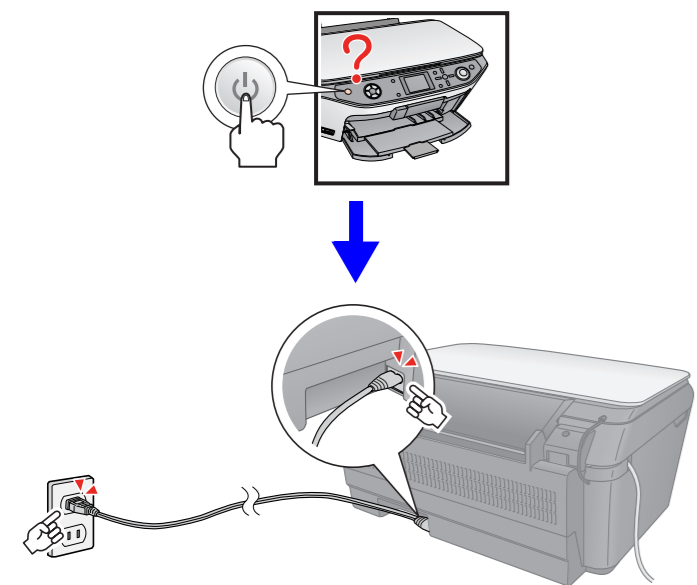

## Does not print

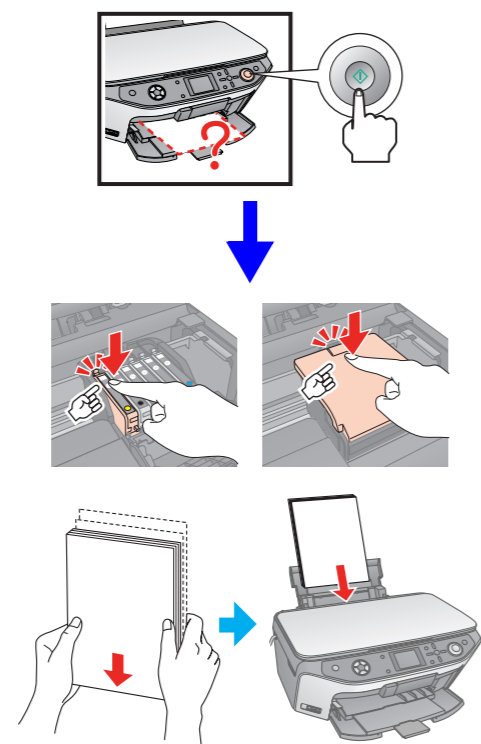

## Does not recognize

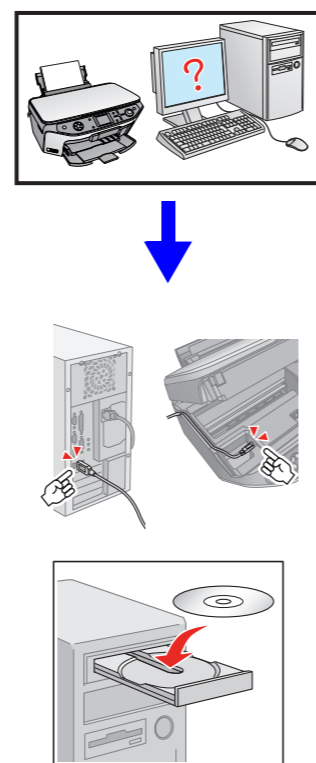

# Features

## Copying

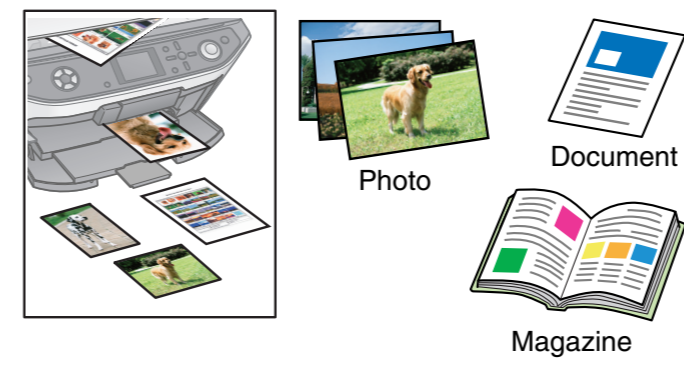

## Printing from Films

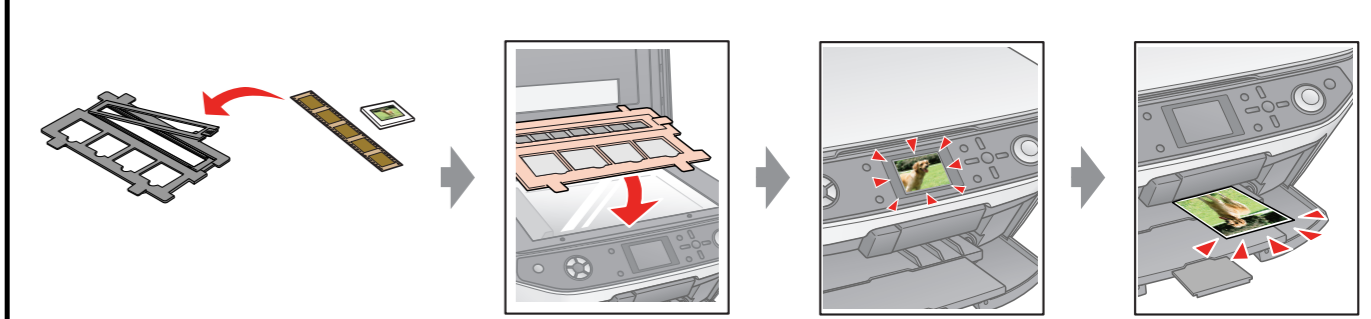

## Memory Card, Camera, and Mobile Phone Printing

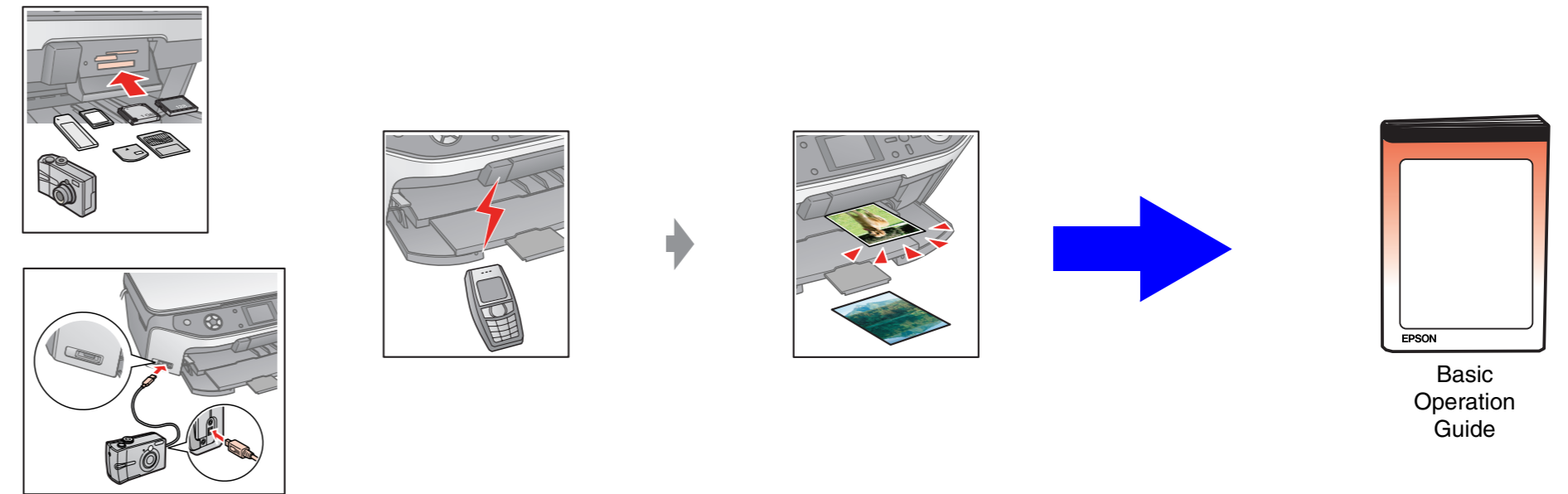

## Printing

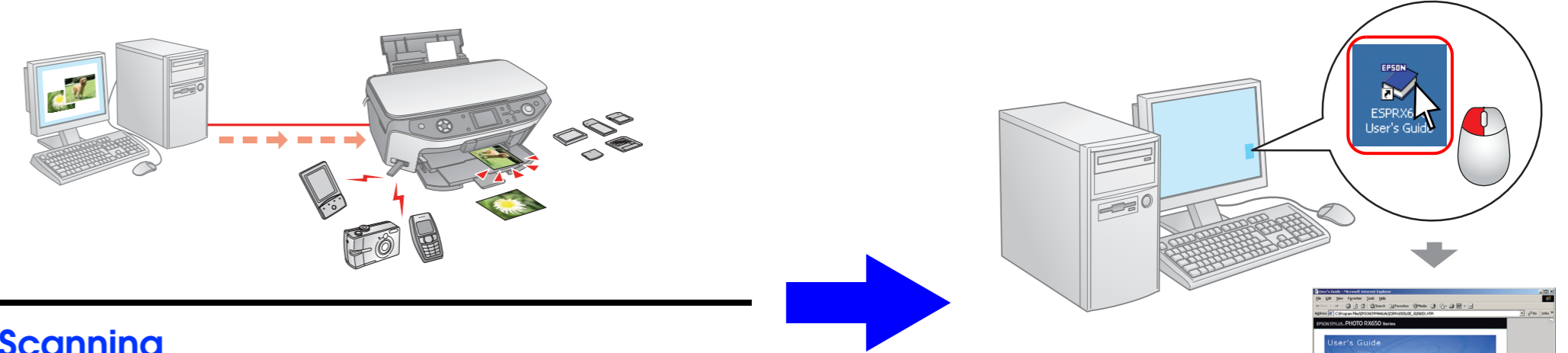

## Scanning

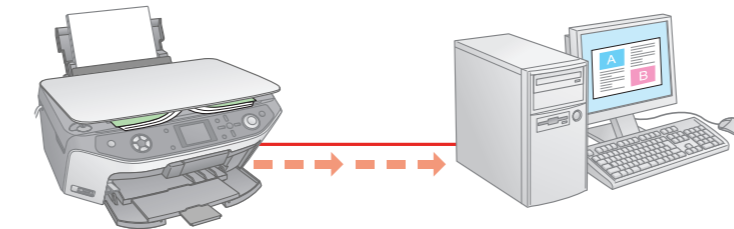

## Storing Film Holder

