



User's Guide

NPD4738-00 EN

Copyright and Trademarks

Copyright and Trademarks

No part of this publication may be reproduced, stored in a retrieval system, or transmitted in any form or by any means, electronic, mechanical, photocopying, recording, or otherwise, without the prior written permission of Seiko Epson Corporation. No patent liability is assumed with respect to the use of the information contained herein. Neither is any liability assumed for damages resulting from the use of the information herein. The information contained herein is designed only for use with this Epson product. Epson is not responsible for any use of this information as applied to other products.

Neither Seiko Epson Corporation nor its affiliates shall be liable to the purchaser of this product or third parties for damages, losses, costs, or expenses incurred by the purchaser or third parties as a result of accident, misuse, or abuse of this product or unauthorized modifications, repairs, or alterations to this product, or (excluding the U.S.) failure to strictly comply with Seiko Epson Corporation's operating and maintenance instructions.

Seiko Epson Corporation and its affiliates shall not be liable for any damages or problems arising from the use of any options or any consumable products other than those designated as Original Epson Products or Epson Approved Products by Seiko Epson Corporation.

Seiko Epson Corporation shall not be held liable for any damage resulting from electromagnetic interference that occurs from the use of any interface cables other than those designated as Epson Approved Products by Seiko Epson Corporation.

EPSON® is a registered trademark, and EPSON EXCEED YOUR VISION or EXCEED YOUR VISION is a trademark of Seiko Epson Corporation.

PRINT Image Matching™ and the PRINT Image Matching logo are trademarks of Seiko Epson Corporation. Copyright © 2001 Seiko Epson Corporation. All rights reserved.

Intel® is a registered trademark of Intel Corporation.

PowerPC® is a registered trademark of International Business Machines Corporation.

Epson Scan software is based in part on the work of the Independent JPEG Group.

libtiff

Copyright © 1988-1997 Sam Leffler
Copyright © 1991-1997 Silicon Graphics, Inc.

Permission to use, copy, modify, distribute, and sell this software and its documentation for any purpose is hereby granted without fee, provided that (i) the above copyright notices and this permission notice appear in all copies of the software and related documentation, and (ii) the names of Sam Leffler and Silicon Graphics may not be used in any advertising or publicity relating to the software without the specific, prior written permission of Sam Leffler and Silicon Graphics.

THE SOFTWARE IS PROVIDED "AS-IS" AND WITHOUT WARRANTY OF ANY KIND, EXPRESS, IMPLIED OR OTHERWISE, INCLUDING WITHOUT LIMITATION, ANY WARRANTY OF MERCHANTABILITY OR FITNESS FOR A PARTICULAR PURPOSE.

Copyright and Trademarks

IN NO EVENT SHALL SAM LEFFLER OR SILICON GRAPHICS BE LIABLE FOR ANY SPECIAL, INCIDENTAL, INDIRECT OR CONSEQUENTIAL DAMAGES OF ANY KIND, OR ANY DAMAGES WHATSOEVER RESULTING FROM LOSS OF USE, DATA OR PROFITS, WHETHER OR NOT ADVISED OF THE POSSIBILITY OF DAMAGE, AND ON ANY THEORY OF LIABILITY, ARISING OUT OF OR IN CONNECTION WITH THE USE OR PERFORMANCE OF THIS SOFTWARE.

Microsoft®, Windows®, and Windows Vista® are registered trademarks of Microsoft Corporation.

Apple®, Macintosh®, Mac OS®, and OS X® are registered trademarks of Apple Inc.

ABBYY® and ABBYY FineReader® names and logos are registered trademarks of ABBYY Software House.

Adobe, Adobe Reader, Acrobat, and Photoshop are trademarks of Adobe systems Incorporated, which may be registered in certain jurisdictions.

General Notice: Other product names used herein are for identification purposes only and may be trademarks of their respective owners. Epson disclaims any and all rights in those marks.

Copyright © 2012 Seiko Epson Corporation. All rights reserved.

Contents

Copyright and Trademarks

Copyright and Trademarks.	2
-----------------------------------	---

Introduction

Where to Find Information.	7
Caution, Important and Note.	7
Operating System Versions.	7
Using Epson Connect Service.	8

Important Instructions

Safety Instructions.	9
Product Advisories and Warnings.	9
Setting up/using the product.	10
Using the product with a wireless connection	11
Using the LCD screen.	11
Handling ink.	12
Restrictions on Copying.	12
Protecting Your Personal Information.	12

Getting to Know Your Product

Product Parts.	13
Guide to the Control Panel.	15
Buttons and LCD.	15
Lights.	16

Paper and Media Handling

Introduction to Using, Loading, and Storing Media.	17
Storing paper.	17
Selecting Paper.	17
Paper type settings on the LCD screen.	18
Paper type settings from the printer driver.	19
Loading Paper and Envelopes.	19
Placing Originals.	22
Automatic Document Feeder (ADF).	22
Scanner glass.	24

Copying

Copying Documents.	26
----------------------------	----

Basic copying.	26
Copy Mode Menu List.	26

Printing

Printer Driver and Status Monitor.	27
Accessing the printer driver for Windows.	27
Accessing the printer driver for Mac OS X.	28
Basic Operations.	29
Basic printing.	29
Canceling printing.	32
Other Options.	33
Printing photos the easy way.	33
Product presets (For Windows Only).	34
2-sided printing (for Windows only).	34
Fit to page printing.	36
Pages per sheet printing.	37
Sharing the Product for Printing.	38
Setup for Windows.	38
Setup for Mac OS X.	40

Scanning

Let's Try Scanning.	41
Starting a Scan.	41
Image Adjustment Features.	43
Basic Scanning from the Control Panel.	45
Scan mode menu list.	46
Basic Scanning from Your Computer.	46
Scanning in Home Mode.	46
Scanning in Office Mode.	48
Scanning in Professional Mode.	50
Previewing and Adjusting the Scan Area.	52
Various Types of Scanning.	54
Scanning a Magazine.	54
Scanning Multiple Documents to a PDF File	55
Scanning a Photo.	58
Software Information.	59
Starting Epson Scan Driver.	59
Starting Other Scanning Software.	60

Faxing

Introducing FAX Utility.	61
Connecting to a Phone Line.	61
About a phone cable.	61

Contents

Using the phone line for fax only. 61
 Sharing line with phone device. 62
 Checking the fax connection. 64
 Notices when the power is turned off. 64
 Setting Up Fax Features. 65
 Setting up speed dial entries. 65
 Setting up group dial entries. 65
 Creating header information. 66
 Sending Faxes. 67
 Sending faxes by entering a number. 67
 Sending faxes using speed dial/group dial. 67
 Sending a fax at a specified time. 68
 Sending a fax from a connected phone. 69
 Receiving Faxes. 70
 Setting up to receive faxes automatically. 70
 Receiving faxes manually. 70
 Receive a fax by polling. 71
 Printing Reports. 72
 Fax Mode Menu List. 72

Menu List of Control Panel

Copy Mode. 73
 Fax Mode. 74
 Scan Mode. 76

Refilling Ink

Ink Bottle Safety Instructions, Precautions, and Specifications. 77
 Safety instructions. 77
 Precautions on refilling ink. 77
 Ink bottle specifications. 78
 Checking the Ink Levels. 78
 Refilling the Ink Tanks. 78

Maintaining Your Product and Software

Checking the Print Head Nozzles. 82
 Using the Nozzle Check utility for Windows 82
 Using the Nozzle Check utility for Mac OS X 82
 Using the control panel. 83
 Cleaning the Print Head. 84
 Using the Head Cleaning utility for Windows 84
 Using the Head Cleaning utility for Mac OS X 84

Using the control panel. 85
 Aligning the Print Head. 85
 Using the Print Head Alignment utility for Windows. 85
 Using the Print Head Alignment utility for Mac OS X. 86
 Using the control panel. 86
 Setting/Changing Time and Region. 87
 Replacing Ink inside the Ink Tubes. 88
 Using the Power Ink Flushing utility for Windows. 88
 Using the Power Ink Flushing utility for Mac OS X. 89
 Using the control panel. 89
 Saving Power. 90
 For Windows. 90
 For Mac OS X. 90
 Using the control panel. 90
 Checking the Number of Sheets of Paper Fed. 91
 Cleaning the Product. 91
 Cleaning the exterior of the product. 91
 Cleaning the interior of the product. 92
 Transporting the Product. 92
 Checking and Installing Your Software. 95
 Checking the software installed on your computer. 95
 Installing the software. 96
 Uninstalling Your Software. 96
 For Windows. 96
 For Mac OS X. 97

Error Indicators

Error Messages on the Control Panel. 99

Troubleshooting for Printing/Copying

Diagnosing the Problem. 101
 Checking product status. 101
 Paper Jams. 103
 Removing jammed paper from inside the product. 104
 Removing jammed paper from the Automatic Document Feeder (ADF). 104
 Preventing paper jams. 106
 Reprinting after a paper jam (for Windows only). 107
 Print Quality Help. 107
 Horizontal banding. 108
 Vertical banding or misalignment. 109

Contents

Incorrect or missing colors.	109
Blurry or smeared print.	110
Miscellaneous Printout Problems.	110
Incorrect or garbled characters.	110
Incorrect margins.	111
Printout has a slight slant.	111
Size or position of copied image is incorrect.	111
Inverted image.	111
Blank pages print.	112
Printed side is smeared or scuffed.	112
Printing is too slow.	112
Paper Does Not Feed Correctly.	113
Paper does not feed.	113
Multiple pages feed.	113
Paper is improperly loaded.	113
Paper is not ejected fully or is wrinkled.	114
The Product Does Not Print.	114
All lights are off.	114
Only the power light is on.	114
Increasing the Print Speed (For Windows Only)	
.	115
Other Problem.	116
Printing plain papers quietly.	116

Troubleshooting for Scanning

Problems Indicated by Messages on the LCD	
Screen or Status Light.	117
Problems When Starting a Scan.	117
Using the Automatic Document Feeder (ADF)	
.	117
Using the button.	118
Using scanning software other than Epson	
Scan driver.	119
Problems When Feeding Paper.	119
The paper gets dirty.	119
Multiple sheets of paper are fed.	119
The paper jams in the Automatic Document	
Feeder (ADF)	119
Problems With Scanning Time.	120
Problems With Scanned Images.	120
Scan quality is unsatisfactory.	120
The scanning area or direction is	
unsatisfactory.	121
Problems Remain After Trying All Solutions.	122

Troubleshooting for Faxing

Cannot send and receive fax.	123
Quality problems (sending).	123

Quality problems (receiving).	124
Answering machine cannot answer voice calls.	124
Incorrect time.	124

Product Information

Ink Bottles.	125
System Requirements.	125
For Windows.	125
For Mac OS X.	125
Technical Specifications.	126
Printer specifications.	126
Scanner specifications.	128
Automatic Document Feeder (ADF)	
specifications.	128
Fax specifications.	128
Network interface specification.	129
Mechanical.	129
Electrical.	130
Environmental.	130
Standards and approvals.	131
Interface.	131

Where To Get Help

Technical Support Web Site.	132
Contacting Epson Support.	132
Before Contacting Epson.	132
Help for Users in Europe.	133
Help for Users in Taiwan.	133
Help for Users in Thailand.	134
Help for Users in Vietnam.	134
Help for Users in Indonesia.	134
Help for Users in Hong Kong.	136
Help for Users in Malaysia.	136
Help for Users in India.	137
Help for Users in the Philippines.	138

Index

Introduction

Where to Find Information

The latest version of the following manuals are available on the Epson support website.

<http://www.epson.eu/Support> (Europe)

<http://support.epson.net/> (other than Europe)

Start Here (paper):

Provides you with information on setting up the product and installing the software.

Basic Guide (paper):

Provides you with basic information when you are using the product without a computer. This manual may not be included depending on the model and region.

User's Guide (PDF):

Provides you with detailed operating, safety, and troubleshooting instructions. See this guide when using this product with a computer.

To view the PDF manual, you need Adobe Acrobat Reader 5.0 or later, or Adobe Reader.

Network Guide (HTML):

Provides network administrators with information on both the printer driver and network settings.

Caution, Important and Note

Caution, Important, and Note in this manual are indicated as below and have the following meaning.



Caution

must be followed carefully to avoid bodily injury.



Important

must be observed to avoid damage to your equipment.

Note

contain useful tips and restrictions on product operation.

Operating System Versions

In this manual, the following abbreviations are used.

Introduction

- ❑ Windows 7 refers to Windows 7 Home Basic, Windows 7 Home Premium, Windows 7 Professional, and Windows 7 Ultimate.
- ❑ Windows Vista refers to Windows Vista Home Basic Edition, Windows Vista Home Premium Edition, Windows Vista Business Edition, Windows Vista Enterprise Edition, and Windows Vista Ultimate Edition.
- ❑ Windows XP refers to Windows XP Home Edition, Windows XP Professional x64 Edition, and Windows XP Professional.
- ❑ Mac OS X refers to Mac OS X 10.5.8 or later.

Using Epson Connect Service

Using Epson Connect, you can easily print directly from your smartphone or tablet. The services available vary by product. For more information about the printing and other services, visit the following URL:

<https://www.epsonconnect.com/> (Epson Connect portal site)

<http://www.epsonconnect.eu> (Europe only)

You can view the Epson Connect guide by double-clicking the  shortcut icon on the desktop.



Important Instructions

Important Instructions

Safety Instructions

Read and follow these instructions to ensure safe use of this product. Make sure you keep this guide for future reference. Also, be sure to follow all warnings and instructions marked on the product.

- Use only the power cord supplied with the product and do not use the cord with any other equipment. Use of other cords with this product or the use of the supplied power cord with other equipment may result in fire or electric shock.
- Be sure your AC power cord meets the relevant local safety standard.
- Never disassemble, modify, or attempt to repair the power cord, plug, printer unit, scanner unit, or options by yourself, except as specifically explained in the product's guides.
- Unplug the product and refer servicing to qualified service personnel under the following conditions:
The power cord or plug is damaged; liquid has entered the product; the product has been dropped or the casing damaged; the product does not operate normally or exhibits a distinct change in performance. Do not adjust controls that are not covered by the operating instructions.
- Place the product near a wall outlet where the plug can be easily unplugged.
- Do not place or store the product outdoors, near excessive dirt or dust, water, heat sources, or in locations subject to shocks, vibrations, high temperature or humidity.
- Take care not to spill liquid on the product and not to handle the product with wet hands.
- Keep this product at least 22 cm away from cardiac pacemakers. Radio waves from this product may adversely affect the operation of cardiac pacemakers.
- If the LCD screen is damaged, contact your dealer. If the liquid crystal solution gets on your hands, wash them thoroughly with soap and water. If the liquid crystal solution gets into your eyes, flush them immediately with water. If discomfort or vision problems remain after a thorough flushing, see a doctor immediately.
- Avoid using a telephone during an electrical storm. There may be a remote risk of electric shock from lightning.
- Do not use a telephone to report a gas leak in the vicinity of the leak.

Note:

The following provides safety instructions for ink.

➔ *"Refilling Ink" on page 77*

Product Advisories and Warnings

Read and follow these instructions to avoid damaging the product or your property. Make sure you keep this guide for future reference.

Important Instructions

Setting up/using the product

- ❑ Do not block or cover the vents and openings in the product.
- ❑ Use only the type of power source indicated on the product's label.
- ❑ Avoid using outlets on the same circuit as photocopiers or air control systems that regularly switch on and off.
- ❑ Avoid electrical outlets controlled by wall switches or automatic timers.
- ❑ Keep the entire computer system away from potential sources of electromagnetic interference, such as loudspeakers or the base units of cordless telephones.
- ❑ The power-supply cords should be placed to avoid abrasions, cuts, fraying, crimping, and kinking. Do not place objects on top of the power-supply cords and do not allow the power-supply cords to be stepped on or run over. Be particularly careful to keep all the power-supply cords straight at the ends and the points where they enter and leave the transformer.
- ❑ If you use an extension cord with the product, make sure that the total ampere rating of the devices plugged into the extension cord does not exceed the cord's ampere rating. Also, make sure that the total ampere rating of all devices plugged into the wall outlet does not exceed the wall outlet's ampere rating.
- ❑ If you plan to use the product in Germany, the building installation must be protected by a 10 or 16 amp circuit breaker to provide adequate short-circuit protection and over-current protection for the product.
- ❑ When connecting the product to a computer or other device with a cable, ensure the correct orientation of the connectors. Each connector has only one correct orientation. Inserting a connector in the wrong orientation may damage both devices connected by the cable.
- ❑ Place the product on a flat, stable surface that extends beyond the base of the product in all directions. If you place the product by the wall, leave more than 10 cm between the back of the product and the wall. The product will not operate properly if it is tilted at an angle.
- ❑ When storing or transporting the product, avoid tilting it, placing it vertically, or turning it upside down; otherwise ink may leak.
- ❑ Allow spaces behind the product for the cables, and space above the product so that you can fully raise the document cover.
- ❑ Leave enough space in front of the product for the paper to be fully ejected.
- ❑ Avoid places subject to rapid changes in temperature and humidity. Also, keep the product away from direct sunlight, strong light, or heat sources.
- ❑ Do not insert objects through the slots in the product.
- ❑ Do not put your hand inside the product during printing.
- ❑ Do not touch the white flat cable and ink tubes inside the product.
- ❑ Do not use aerosol products that contain flammable gases inside or around the product. Doing so may cause fire.
- ❑ Do not move the print head by hand; otherwise, you may damage the product.

Important Instructions

- ❑ Always turn the product off using the ⏻ button. Do not unplug the product or turn off the power at the outlet until the LCD screen has turned off completely.
- ❑ Before transporting the product, make sure that the print head is in the home (far right) position.
- ❑ Be careful not to trap your fingers when closing the scanner unit.
- ❑ Do not continue printing when the ink level is below the lower limit on the ink tank. Continued use of the product when the ink level is below the lower limit could damage the product. Epson recommends filling all ink tanks to the upper line when the product is not operating to reset the ink levels. If the ink tank is filled as specified above, this product provides an alert and stops operating at the estimated time so that the ink levels do not fall below the lower limit on the ink tank.
- ❑ If you are not going to use the product for a long period, be sure to unplug the power cord from the electrical outlet.
- ❑ Do not press too hard on the scanner glass when placing the originals.
- ❑ During the life of your product it may be necessary to replace the waste ink pad when it has become full. Whether and how often this is required will vary according to the number of pages you print, the type of material that you print and the number of cleaning cycles that the product performs. Epson Status Monitor, your LCD, or lights on the control panel will advise you when this part needs replacing. The need for replacement of the pad does not mean that your product has ceased to operate in accordance with its specifications. The replacement of this part is a routine product servicing activity within the product's specification and is not a problem which requires repair. The Epson warranty does not therefore cover the cost of this replacement. If your product needs the pad replacing this can be performed for you by any authorised Epson service provider. It is not a user-serviceable part.

Using the product with a wireless connection

Note:

The availability of this feature varies by product.

- ❑ Do not use this product inside medical facilities or near medical equipment. Radio waves from this product may adversely affect the operation of electrical medical equipment.
- ❑ Do not use this product near automatically controlled devices such as automatic doors or fire alarms. Radio waves from this product may adversely affect these devices, and could lead to accidents due to malfunction.

Using the LCD screen

- ❑ The LCD screen may contain a few small bright or dark spots, and because of its features it may have an uneven brightness. These are normal and do not indicate that it is damaged in any way.
- ❑ Only use a dry, soft cloth to clean the LCD screen. Do not use liquid or chemical cleansers.
- ❑ The exterior cover of the LCD screen could break if it receives a heavy impact. Contact your dealer if the panel surface chips or cracks, and do not touch or attempt to remove the broken pieces.

Important Instructions

Handling ink

➔ [“Refilling Ink” on page 77](#)

Restrictions on Copying

Observe the following restrictions in order to ensure the responsible and legal use of the product.

Copying of the following items is prohibited by law:

- Bank bills, coins, government-issued marketable securities, government bond securities, and municipal securities
- Unused postage stamps, pre-stamped postcards, and other official postal items bearing valid postage
- Government-issued revenue stamps, and securities issued according to legal procedure

Exercise caution when copying the following items:

- Private marketable securities (stock certificates, negotiable notes, checks, etc.), monthly passes, concession tickets, etc.
- Passports, driver's licenses, warrants of fitness, road passes, food stamps, tickets, etc.

Note:

Copying these items may also be prohibited by law.

Responsible use of copyrighted materials:

- Products can be misused by improperly copying copyrighted materials. Unless acting on the advice of a knowledgeable attorney, be responsible and respectful by obtaining the permission of the copyright holder before copying published material.

Protecting Your Personal Information

This product allows you to store names and telephone numbers in its memory even when the power is turned off.

Use the following menu to erase the memory if you give the product to someone else or dispose of it.

Press  and select **Restore Default Settings > Reset All Settings**.

Getting to Know Your Product

Product Parts

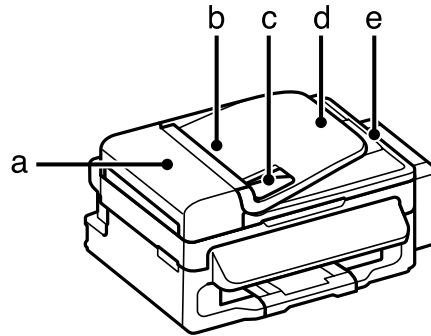

a.	ADF cover
b.	Automatic Document Feeder (ADF)
c.	Edge guide
d.	ADF input tray (place your originals here to be copied)
e.	ADF output tray (your originals are ejected here as they are copied)

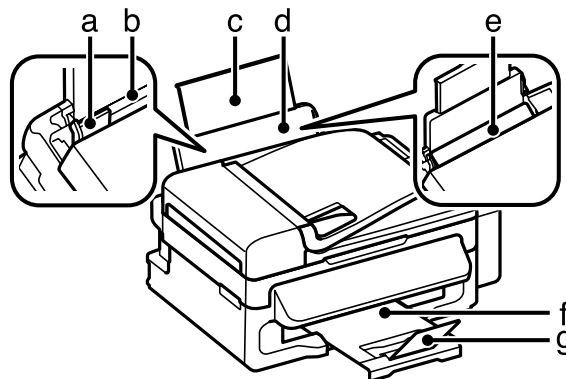

a.	Edge guide
b.	Rear paper feed
c.	Paper support extension
d.	Paper support
e.	Feeder guard
f.	Output tray
g.	Stopper

Getting to Know Your Product

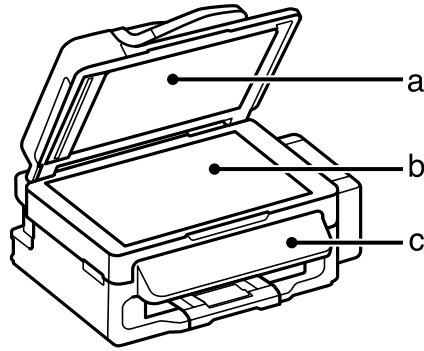

a.	Document cover
b.	Scanner glass
c.	Control panel

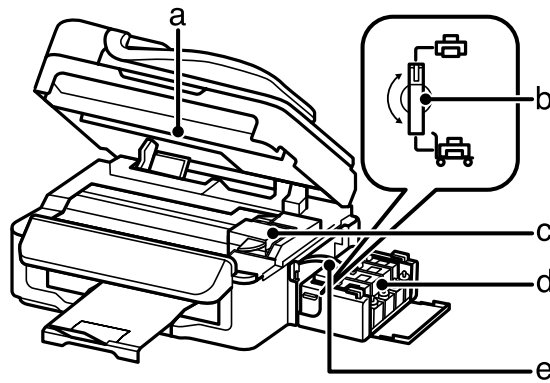

a.	Scanner Unit
b.	Transportation lock
c.	Print head (under this section)
d.	Ink reservoir tanks (Ink tanks)
e.	Ink tubes

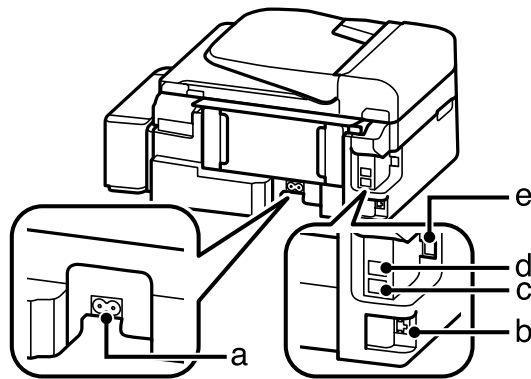

a.	AC inlet
b.	LAN port*

Getting to Know Your Product

c.	EXT. port
d.	LINE port
e.	USB connector

* The availability of this part varies by product.

Guide to the Control Panel

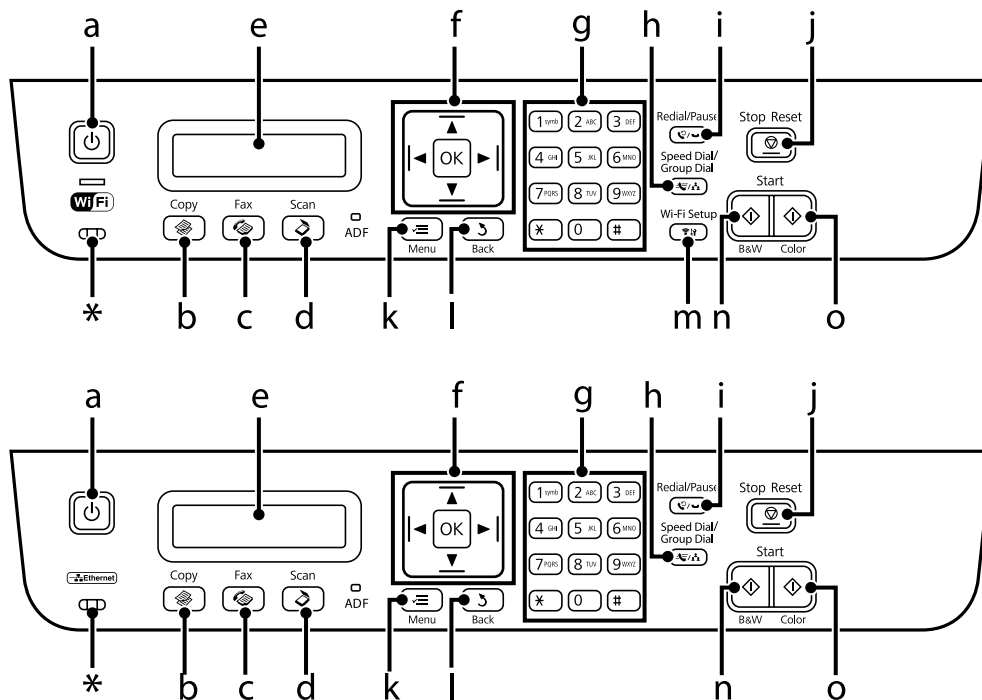









* emits a beep.



Buttons and LCD

	Buttons	Function
a		Turns the product on and off
b		Enters copy mode.
c		Enters fax mode.
d		Enters scan mode.
e	-	LCD screen (monochrome 2-line display)
f		Press , , , to select menus. Press OK to confirm the setting you have selected and go to next screen. When typing a fax number, acts as a backspace key, and inserts a space.

Getting to Know Your Product

	Buttons	Function
g	0-9,*,#	Specifies the date/time or the number of copies, as well as fax numbers. Enters alphanumeric characters and switches between uppercase, lowercase, and numbers each time it is pressed. Press 1 symb to enter symbols such as the sharp sign (#), plus (+), and apostrophe (').
h		Displays speed dial/group dial lists. Press again to switch lists.
i		Displays the last number dialed. When entering numbers in fax mode, this inserts a pause symbol (-) that acts as a brief pause during dialing.
j		Stops the ongoing operation or initializes the current settings. If this button is pressed to cancel copying, scanning, or faxing while the ADF is in use, all originals in the ADF will be fed out.
k		Displays detailed settings for each mode.
l		Cancels/returns to the previous menu.
m		Provided with Wi-Fi-capable models only. Displays the Wi-Fi Setup menus that allow you to set up the product wirelessly. For instructions on using the menus, see the Network Guide.
n		Start copying/faxing in black and white.
o		Start copying/faxing in color.

Lights

Lights	Function
	On when the product is on. Flashes when the product is receiving data, printing/copying/scanning/faxing, charging ink, or cleaning the print head.
	Stays on while the product is connected to a Wi-Fi network. Flashes while the Wi-Fi network settings are being made. This light turns off in sleep mode*.
ADF	On when originals are detected in the ADF.

* The availability of this part varies by product.

Paper and Media Handling

Introduction to Using, Loading, and Storing Media

You can achieve good results with most types of plain paper. However, coated papers provide superior prints because they absorb less ink.

Epson provides special papers that are formulated for the ink used in Epson ink jet products, and recommends these papers to ensure high-quality results.

When loading special paper distributed by Epson, read the instruction sheets packed with the paper first and keep the following points in mind.

Note:

- ❑ *Load the paper into the rear paper feed printable side up. The printable side is usually whiter or glossier. See the instruction sheets packed with the paper for more information. Some types of paper have cut corners to help identify the correct loading direction.*
- ❑ *If the paper is curled, flatten it or curl it slightly in the opposite direction before loading. Printing on curled paper may cause ink to smear on your prints. Do not use the paper that is folded, wavy or torn.*

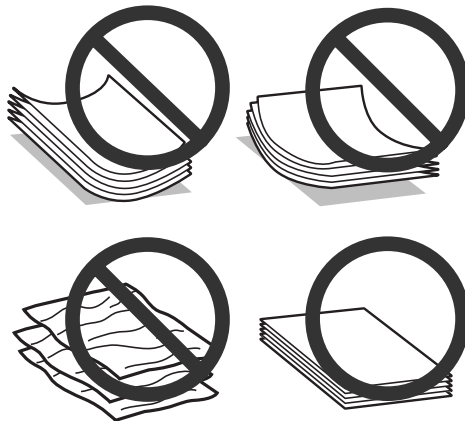

Storing paper

Return unused paper to the original package as soon as you finish printing. When handling special media, Epson recommends storing your prints in a resealable plastic bag. Keep unused paper and prints away from high temperature, humidity, and direct sunlight.

Selecting Paper

Refer to the table below for the loading capacities of paper and other media.

Paper and Media Handling

Media Type	Size	Loading capacity (sheets)
Plain paper* ¹	Letter* ²	up to 11mm
	A4* ²	up to 11mm
	B5* ²	up to 11mm
	A5* ²	up to 11mm
	A6* ²	up to 11mm
	Legal	1
	User Defined	1
Envelope	#10	10
	DL	10
	C6	10
Epson Bright White Ink Jet Paper	A4* ²	80
Epson Photo Quality Ink Jet Paper	A4	80
Epson Matte Paper - Heavyweight	A4	1
Epson Premium Glossy PhotoPaper	A4	20
	10 × 15 cm (4 × 6 in.)	20
	13 × 18 cm (5 × 7 in.)	20
	16:9 wide size (102 × 181mm)	20

*1 Paper with a weight of 64 g/m² (17 lb) to 90 g/m² (24 lb).

*2 The loading capacity for manual 2-sided printing is 30 sheets.

Note:

The availability of paper varies by location.

Paper type settings on the LCD screen

The product automatically adjusts itself for the type of paper you select in your print settings. That is why the paper type setting is so important. It tells your product what kind of paper you are using and adjusts the ink coverage accordingly. The table below lists the settings you should choose for your paper.

For this paper	LCD paper type
Plain paper	Plain Paper
Epson Bright White Ink Jet Paper	

Paper type settings from the printer driver

The product automatically adjusts itself for the type of paper you select in your print settings. That is why the paper type setting is so important. It tells your product what kind of paper you are using and adjusts the ink coverage accordingly. The table below lists the settings you should choose for your paper.

For this paper	Printer driver paper type
Plain paper*	plain papers
Epson Bright White Ink Jet Paper*	
Epson Premium Glossy Photo Paper*	Epson Premium Glossy
Epson Matte Paper – Heavyweight*	Epson Matte
Epson Photo Quality Ink Jet Paper*	
Envelopes	Envelope

* These paper types are compatible with Exif Print and PRINT Image Matching. For more information, refer to the documentation that came with the Exif Print or PRINT Image Matching compatible digital camera.

Note:

The availability of special media varies by location. For the latest information on media available in your area, contact Epson support.

➔ [“Technical Support Web Site” on page 132](#)

Loading Paper and Envelopes

Follow these steps to load paper:

- 1 Flip the feeder guard forward.

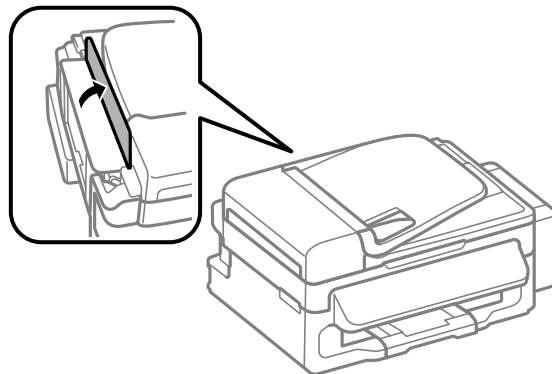

Paper and Media Handling

- 2 Slide out the paper support and the output tray and then raise the stopper.

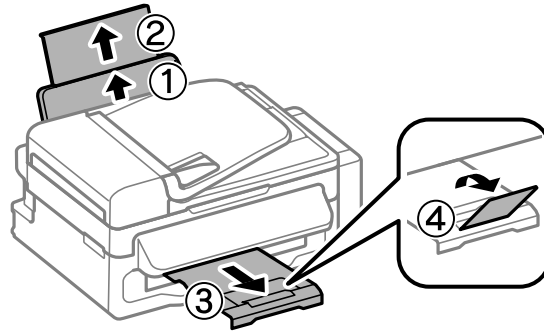

Note:

Leave enough space in front of the product for the paper to be fully ejected.

- 3 Slide the edge guide to the left.

- 4 Load paper with the printable side up, against the right side of the rear paper feed.

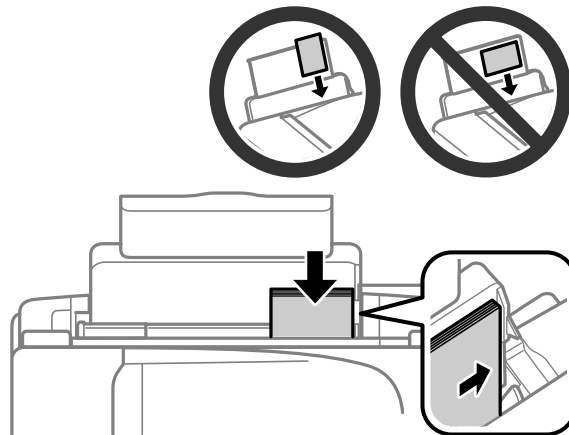

Paper and Media Handling

Note:

- ❑ Fan and align the edges of the paper before loading.
- ❑ The printable side is often whiter or brighter than the other side.
- ❑ Always load paper into the rear paper feed short edge first, even when you are printing landscape -oriented pictures.
- ❑ You can use the following sizes of paper with binding holes: A4, A5, A6, Legal, Letter. Load only 1 sheet of paper at a time.
- ❑ When loading envelopes, load the short edge first with the flap facing down.

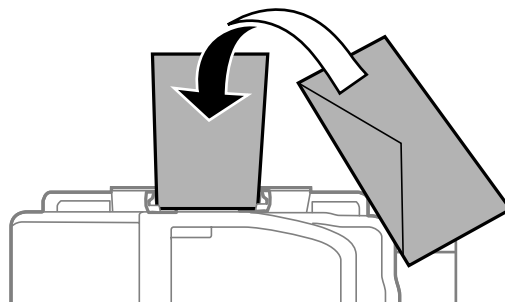

- ❑ Do not use envelopes that are curled, folded, or glued or that have plastic windows.
- ❑ Flatten the envelope and the flaps before loading.

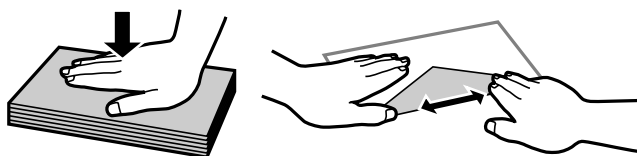

- ❑ Flatten the leading edge of the envelope before loading.
- ❑ Avoid using envelopes that are too thin, as they may curl during printing.

5

Slide the edge guide against the left edge of the paper, but not too tightly.

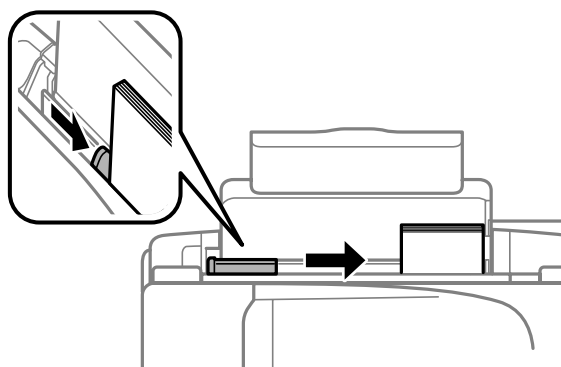

Note:

For plain paper, do not load paper above the ▼ arrow mark inside the edge guide.
For Epson special media, make sure the number of sheets is less than the limit specified for the media.

➔ [“Selecting Paper” on page 17](#)

Paper and Media Handling

6 Flip the feeder guard back.

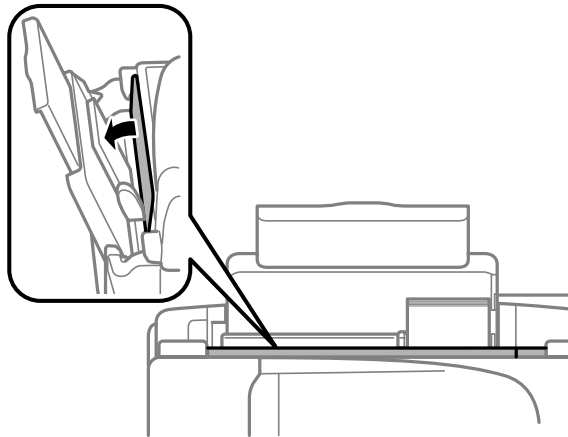

Placing Originals

Automatic Document Feeder (ADF)

You can load your original documents in the Automatic Document Feeder (ADF) to copy, scan, or fax multiple pages quickly. You can use the following originals in the ADF.

Size	A4/Letter/Legal
Type	Plain paper
Weight	64 g/m ² to 95 g/m ²
Capacity	Total thickness of 3 mm, up to about 30 sheets (Letter, A4) 10 sheets (Legal)

! **Important:**

To prevent paper jams, avoid the following documents. For these types, use the scanner glass.

- Documents held together with paper clips, staples, etc.
- Documents that have tape or paper stuck to them.
- Photos, OHPs, or thermal transfer paper.
- Paper that is torn, wrinkled, or has holes.

1 Make sure that there are no originals on the scanner glass. The ADF may not detect documents in the feeder if there are originals on the scanner glass.

Paper and Media Handling

- 2** Tap the originals on a flat surface to even the edges.

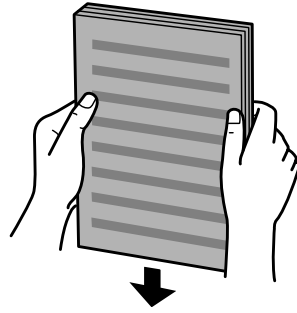

- 3** Slide the edge guide on the Automatic Document Feeder.

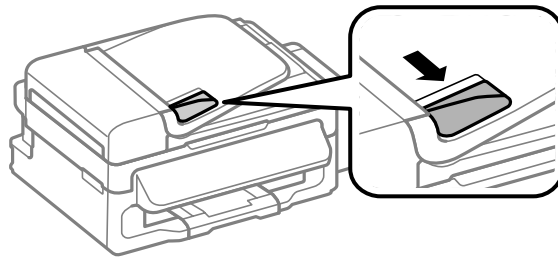

- 4** Insert the originals face-up and short edge first into the Automatic Document Feeder.

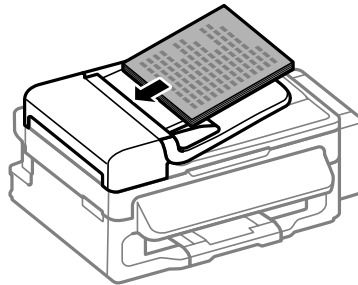

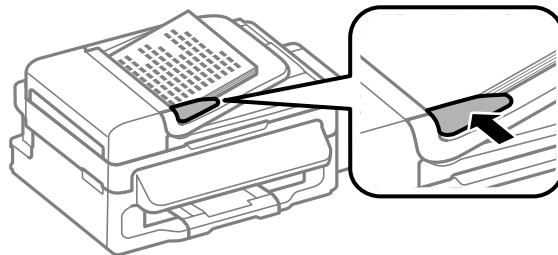

- 5** Slide the edge guide until it is flush with the originals.



Paper and Media Handling

- 6** Check that the ADF light in the control panel is on.

Note:

- ❑ The ADF light may stay off if there is any other original on the scanner glass. If you press  in this case, the original on the scanner glass will be copied, scanned, or faxed instead of the originals in the ADF.
- ❑ The ADF light will not turn on when the product is in sleep mode. Press any button other than  to recover from sleep mode. It may take some time for the light to turn on after recovery from sleep mode.
- ❑ Be careful not to let any foreign object get inside the hole on the left front corner of the scanner glass. Doing so may prevent the ADF from operating.
- ❑ When you use the copy function with the Automatic Document Feeder (ADF), the print settings are fixed at Reduce/Enlarge - **Actual Size**, Paper Type - **Plain Paper**, and Paper Size - **A4/Legal**. The print is cropped if you copy an original larger than A4/Legal.

Scanner glass

- 1** Open the document cover and place your original face-down on the scanner glass.

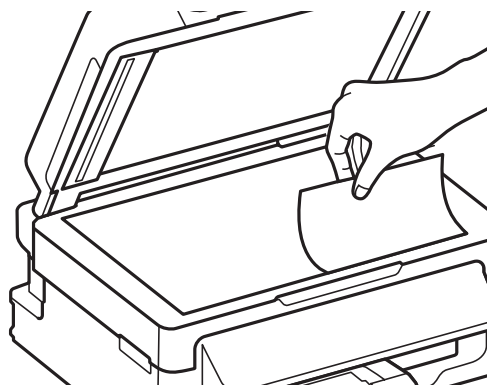

- 2** Slide the original to the corner.

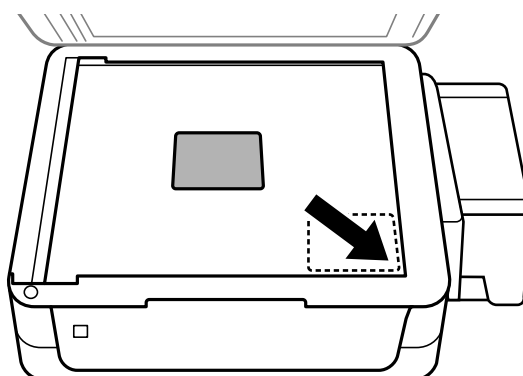

Note:

See the following sections if any problems occur with the scanning area or the scanning direction when using EPSON Scan.

- ➔ “The edges of your original are not scanned” on page 121
- ➔ “Multiple documents are scanned into a single file” on page 122

Paper and Media Handling









- 3 Close the cover gently.

Copying

Copying Documents

Basic copying

Follow the steps below to copy documents.

- 1 Load paper.
➔ [“Loading Paper and Envelopes” on page 19](#)
- 2 Place your original(s) in the Automatic Document Feeder or on the scanner glass.
➔ [“Placing Originals” on page 22](#)
- 3 Press  to enter the copy mode.
- 4 Press  or  to set the number of copies.
- 5 Press  to display the copy setting menus.
- 6 Select the appropriate copy settings such as layout, paper size, paper type, and quality. Use  or  to select a setting item and then press **OK**. When finished, press  again to return to the copy mode top screen.
- 7 Press one of the  buttons to start copying.

Copy Mode Menu List

Refer to the section below for the Copy mode menu list.

➔ [“Copy Mode” on page 73](#)

Printing

Printer Driver and Status Monitor

The printer driver lets you choose from a wide variety of settings to get the best printing results. The status monitor and the printer utilities help you check the product and keep it in top operating condition.

Note for Windows users:

- ❑ Your printer driver automatically finds and installs the latest version of the printer driver from Epson's Web site. Click the **Software Update** button in your printer driver's **Maintenance** window, and then follow the on-screen instructions. If the button does not appear in the **Maintenance** window, point at **All Programs** or **Programs** in the Windows Start menu, and check in the **EPSON** folder.
- ❑ If you want to change the language of the driver, select the language you want to use from the **Language** setting in your printer driver's **Maintenance** window. Depending on the location, this function may not be available.

Accessing the printer driver for Windows

You can access the printer driver from most Windows applications, the Windows Start menu, or the taskbar.

To make settings that apply only to the application you are using, access the printer driver from that application.

To make settings that apply to all of your Windows applications, access the printer driver from the Start menu or the taskbar.

Refer to the following sections to access the printer driver.

Note:

Screen shots of the printer driver windows in this User's Guide are from Windows 7.

From Windows applications

- 1 Click **Print** or **Print Setup** on the File menu.
- 2 In the window that appears, click **Printer**, **Setup**, **Options**, **Preferences**, or **Properties**. (Depending on your application, you may need to click one or a combination of these buttons.)

From the Start menu

- ❑ **Windows 7:**
Click the start button, select **Devices and Printers**. Then right-click the product and select **Printing preferences**.
- ❑ **Windows Vista:**
Click the start button, select **Control Panel**, and then select **Printer** from the **Hardware and Sound** category. Then select the product and then click **Select printing preferences**.

Printing

❑ Windows XP:

Click **Start, Control Panel, (Printers and Other Hardware,)** then **Printers and Faxes**. Select the product, then click **Printing Preferences** on the File menu.

From the shortcut icon on the taskbar

Right-click the product icon on the taskbar, then select **Printer Settings**.

To add a shortcut icon to the Windows taskbar, first access the printer driver from the Start menu as described above. Next, click the **Maintenance** tab, and then the **Monitoring Preferences** button. In the Monitoring Preferences window, select the **Shortcut Icon** check box.

Getting information through online help

In the printer driver window, try one of the following procedures.

- ❑ Right-click the item, then click **Help**.
- ❑ Click the  button at the top right of the window, then click the item (for Windows XP only).

Accessing the printer driver for Mac OS X

The table below describes how to access the printer driver dialog.

Dialog Box	How to Access It
Page Setup	Click Page Setup on the File menu of your application. <i>Note:</i> <i>Depending on your application, the Page Setup menu may not appear in the File menu.</i>
Print	Click Print on the File menu of your application.
Epson Printer Utility 4	For Mac OS X 10.7, click System Preferences on the Apple menu and then click Print & Scan . Select your product from the Printers list box, click Options & Supplies, Utility , and then click Open Printer Utility . For Mac OS X 10.6, click System Preferences on the Apple menu and then click Print & Fax . Select your product from the Printers list box, click Options & Supplies, Utility , and then click Open Printer Utility . For Mac OS X 10.5, click System Preferences on the Apple menu and then click Print & Fax . Select your product from the Printers list box, click Open Print Queue and then click Utility button.

Getting information through online help

Click the  **Help** button in the Print dialog box.

Basic Operations

Basic printing

Note:

- The screen shots in this section may vary depending on the model.
- Before you print, load paper properly.
 - ➔ [“Loading Paper and Envelopes” on page 19](#)
- Refer to the section below for the printable area.
 - ➔ [“Printable area” on page 127](#)
- After completing the settings, print one test copy and examine the results before printing an entire job.

Basic product settings for Windows

- 1 Open the file you want to print.
- 2 Access the printer settings.
 - ➔ [“Accessing the printer driver for Windows” on page 27](#)

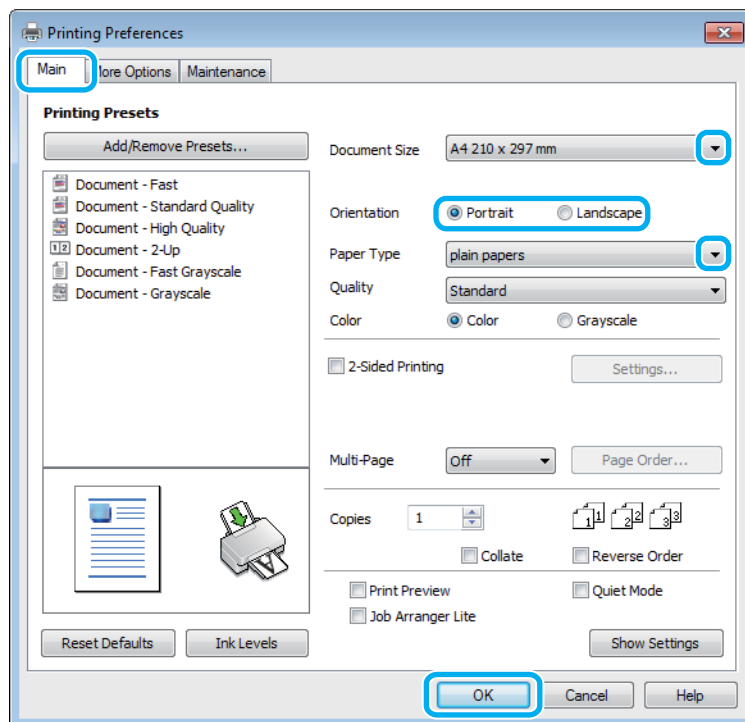

- 3 Click the **Main** tab.
- 4 Select the appropriate Document Size setting. You can also define a custom paper size. For details, see the online help.

Printing

- 5 Select **Portrait** (tall) or **Landscape** (wide) to change the orientation of your print.

Note:
Select **Landscape** when printing on envelopes.

- 6 Select the appropriate Paper Type setting.
➔ [“Paper type settings from the printer driver”](#) on page 19

Note:
Print quality is automatically adjusted for the selected Paper Type.

- 7 Click **OK** to close the printer settings window.

Note:
To make changes to advanced settings, refer to the relevant section.

- 8 Print your file.

Basic product settings for Mac OS X

Note:
Screen shots of the printer driver windows in this section are from Mac OS X 10.7.

- 1 Open the file you want to print.

Printing

- 2 Access the Print dialog box.
 ➔ “Accessing the printer driver for Mac OS X” on page 28

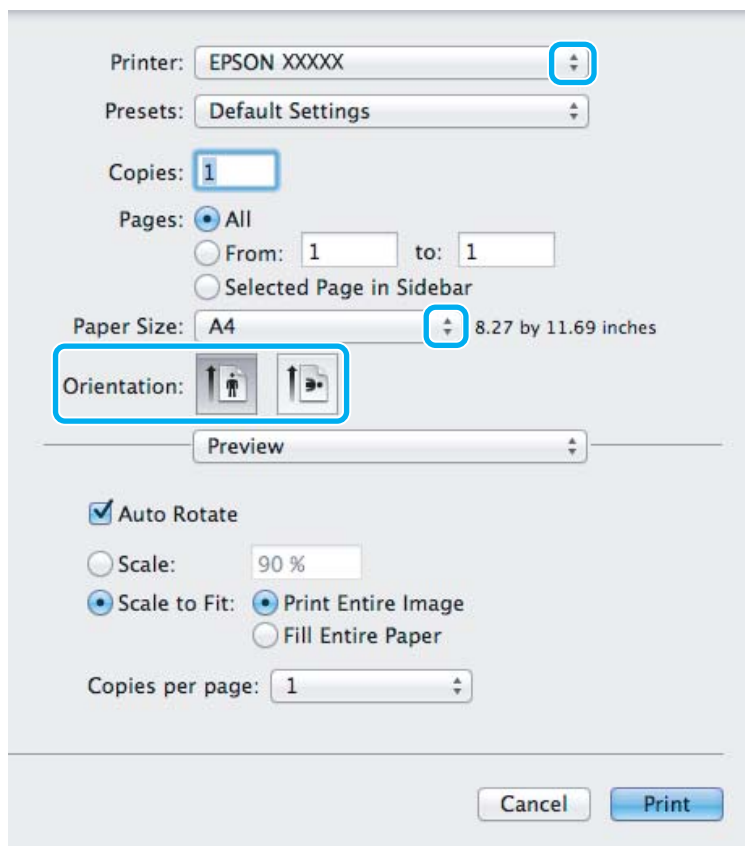

Note:

If the simplified dialog box is displayed, click the **Show Details** button (for Mac OS X 10.7) or the ▼ button (for Mac OS X 10.6 or 10.5) to extend this dialog box.

- 3 Select the product you are using as the Printer setting.

Note:

Depending on your application, you may not be able to select some of the items in this dialog box. If so, click **Page Setup** on the File menu of your application, and then make suitable settings.

- 4 Select the appropriate Paper Size setting.

- 5 Select the appropriate Orientation setting.

Note:

Select landscape orientation when printing envelopes.

Printing

- 6** Select **Print Settings** from the pop-up menu.

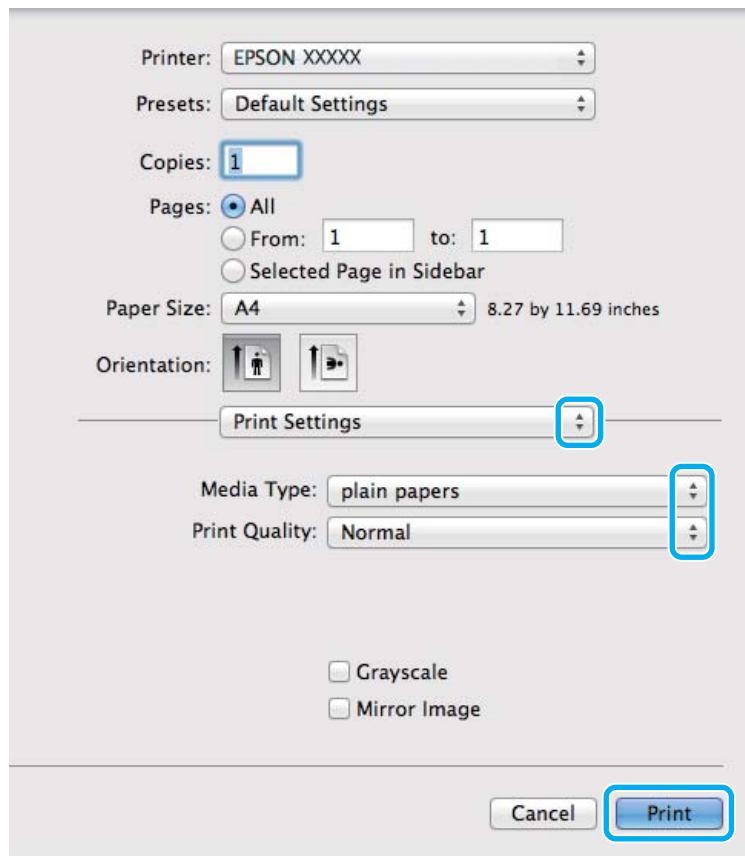

- 7** Select the appropriate Media Type setting.
 ➔ “Paper type settings from the printer driver” on page 19

- 8** Click **Print** to start printing.

Canceling printing

If you need to cancel printing, follow the instructions in the appropriate section below.

Using the product button

Press  to cancel a print job in progress.

For Windows

Note:

You cannot cancel a print job that has been completely sent to the product. In this case, cancel the print job by using the product.

- 1** Access the EPSON Status Monitor 3.
 ➔ “For Windows” on page 101

Printing

- 2 Click the **Print Queue** button. The Windows Spooler appears.
- 3 Right-click on the job you want to cancel and then select **Cancel**.

For Mac OS X

Follow the steps below to cancel a print job.

- 1 Click your product icon in the Dock.
- 2 In the Document Name list, select the document which is printing.
- 3 Click the **Delete** button to cancel the print job.

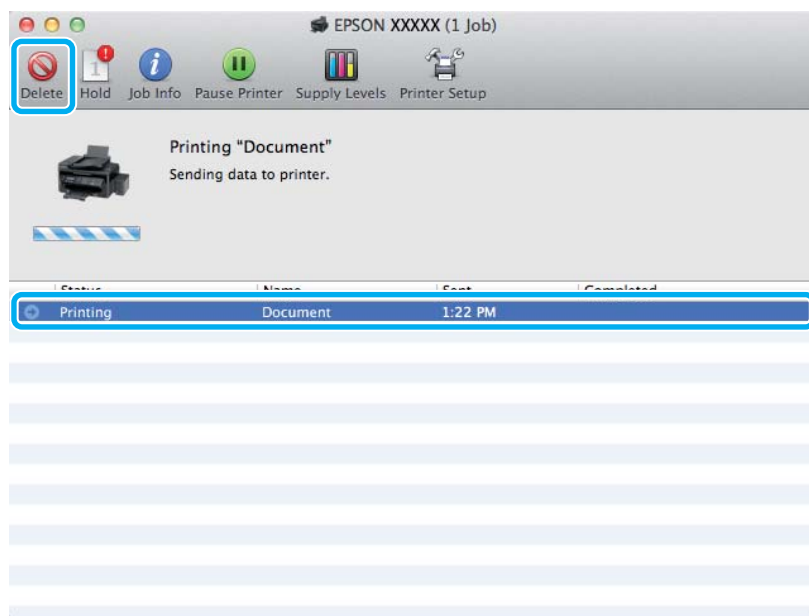

Other Options

Printing photos the easy way



Epson Easy Photo Print lets you lay out and print digital images on various types of paper. The step-by-step instructions in the window let you preview the printed images and get the effects you want without having to make any difficult settings.

Printing

Using the Quick Print function, you can perform one-click printing with the settings you make.

Starting Epson Easy Photo Print

For Windows

- ❑ Double-click the **Epson Easy Photo Print** icon on the desktop.
- ❑ **For Windows 7 and Vista:**
Click the start button, point to **All Programs**, click **Epson Software**, and then click **Easy Photo Print**.

For Windows XP:

Click **Start**, point to **All Programs**, point to **Epson Software**, then click **Easy Photo Print**.

For Mac OS X

Double-click the **Applications** folder on your Mac OS X hard drive, then double-click in turn on the **Epson Software** and **Easy Photo Print** folders and finally double-click the **Easy Photo Print** icon.

Product presets (For Windows Only)

Printer driver presets make printing a snap. You can also create presets of your own.

Product settings for Windows

- 1** Access the printer settings.
➔ [“Accessing the printer driver for Windows” on page 27](#)
- 2** Select a Printing Presets in the Main tab. Product settings are automatically set to the values displayed in the pop-up window.

2-sided printing (for Windows only)

Use the printer driver to print on both sides of the paper.

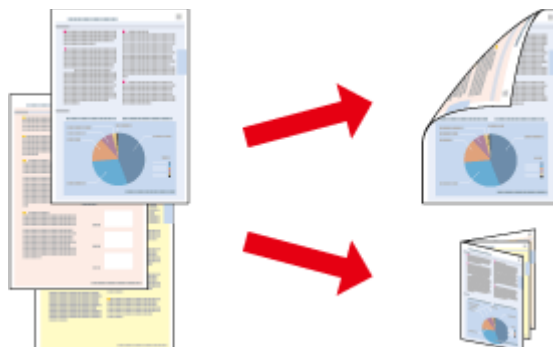

Two types of 2-sided printing are available: standard and folded booklet.

2-sided printing is only available for the following papers and sizes.

Printing

Paper	Size
Plain paper	Legal, Letter, A4, B5, A5, A6
Epson Bright White Ink Jet Paper	A4

Note:

- This feature is not available for Mac OS X.
- This feature may not be available at some settings.
- This feature may not be available when the product is accessed over a network or is used as a shared printer.
- The loading capacity differs during 2-sided printing.
➔ [“Selecting Paper” on page 17](#)
- Only use papers that are suitable for 2-sided printing. Otherwise, the printout quality may deteriorate.
- Depending on the paper and the amount of ink used to print text and images, ink may bleed through to the other side of the paper.
- The surface of the paper may be smeared during 2-sided printing.
- This feature is available only when EPSON Status Monitor 3 is enabled. To enable the status monitor, access the printer driver and click the **Maintenance** tab followed by the **Extended Settings** button. In the Extended Settings window, check the **Enable EPSON Status Monitor 3** check box.

Product settings for Windows

- 1** Access the printer settings.
➔ [“Accessing the printer driver for Windows” on page 27](#)
- 2** Select **2-Sided Printing** check box.
- 3** Click **Settings**, and make the appropriate settings.

Note:

If you want to print a folded booklet, select **Booklet**.

- 4** Check the other settings and print.

Note:

- The actual binding margin may be different from the specified settings depending on your application. Experiment with a few sheets to examine actual results before printing the entire job.
- Make sure that the ink is completely dry before reloading the paper.

Fit to page printing

Lets you automatically enlarge or reduce the size of your document to fit the paper size selected in the printer driver.

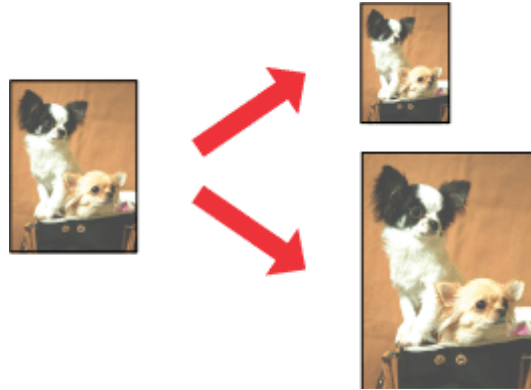
**Note:**

This feature may not be available at some settings.

Product settings for Windows

- 1 Access the printer settings.
➔ [“Accessing the printer driver for Windows” on page 27](#)
- 2 Select **Reduce/Enlarge Document** and **Fit to Page** in the More Options tab, and then select the size of the paper you are using from Output Paper.
- 3 Check the other settings and print.

Product settings for Mac OS X

- 1 Access the Print dialog box.
➔ [“Accessing the printer driver for Mac OS X” on page 28](#)
- 2 Choose **Scale to fit paper size** for Destination Paper Size in the Paper Handling pane and select the desired paper size from the pop-up menu.
- 3 Check the other settings and print.

Pages per sheet printing

Lets you use the printer driver to print two or four pages on a single sheet of paper.

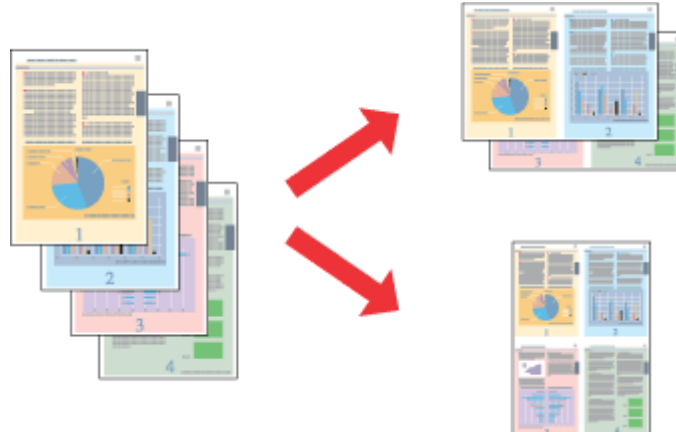
**Note:**

This feature may not be available at some settings.

Product settings for Windows

- 1 Access the printer settings.
➔ [“Accessing the printer driver for Windows” on page 27](#)
- 2 Select **2-Up** or **4-Up** as Multi-Page in the Main tab.
- 3 Click **Page Order**, and make the appropriate settings.
- 4 Check the other settings and print.

Product settings for Mac OS X

- 1 Access the Print dialog box.
➔ [“Accessing the printer driver for Mac OS X” on page 28](#)
- 2 Select the desired number of Pages per Sheet and the Layout Direction (page order) in the Layout pane.
- 3 Check the other settings and print.

Sharing the Product for Printing

Setup for Windows

These instructions tell you how to set up your product so other users on the network can share it.

First you will set up the product as a shared printer on the computer directly connected to it. Then you will add the product to each network computer that will access it.

Note:

- These instructions are for small networks only. To share the product on a large network, consult your network administrator.*
- The screen shots in the following section are from Windows 7.*

Setting up the product as a shared printer

Note:

- To set up the product as a shared printer in Windows 7 or Vista, you will need an account with administrator privileges and the password if you log on as a standard user.*
- To set up the product as a shared printer in Windows XP, you must log on to a Computer Administrator account.*

Follow the steps below on the computer that is connected directly to the product:

1**Windows 7:**

Click the start button, select **Devices and Printers**.

Windows Vista:

Click the start button, select **Control Panel**, and then select **Printer** from the **Hardware and Sound** category.

Windows XP:

Click **Start** and select **Control Panel**, and then select **Printers and Faxes**, from the **Printers and Other Hardware** category.

2**Windows 7:**

Right-click the icon for your product, click **Printer properties**, and then click **Sharing**. Then click the **Change Sharing Options** button.

Windows Vista:

Right-click the icon for your product, and then click **Sharing**. Click the **Change sharing options** button and then click **Continue**.

Windows XP:

Right-click the icon for your product, then click **Sharing**.

3

Select **Share this printer**, then type a Share name.

Note:

Do not use spaces or hyphens in the share name.

Printing

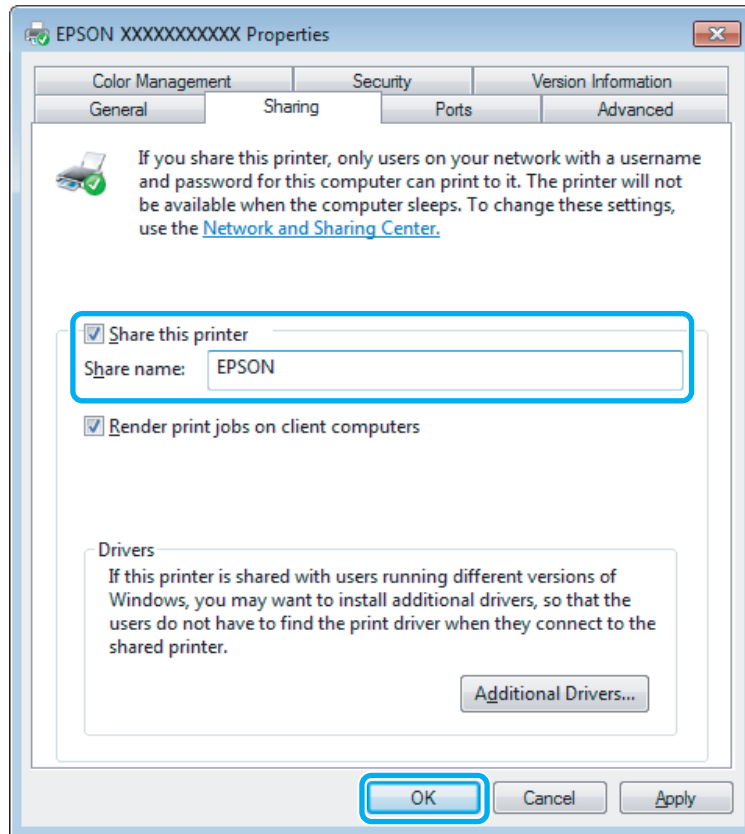

If you want to automatically download printer drivers for computers that are running different versions of Windows, click **Additional Drivers** and select the environment and the operating systems of the other computers. Click **OK**, then insert the product software disk.

- 4 Click **OK** or **Close** (if you installed additional drivers).

Adding the product to the other network computers

Follow these steps to add the product to each network computer that will access it.

Note:

Your product must be set up as a shared printer on the computer to which it is connected before you can access it from another computer.

➔ [“Setting up the product as a shared printer” on page 38.](#)

- 1 **Windows 7:**
Click the start button, select **Devices and Printers**.

Windows Vista:

Click the start button, select **Control Panel**, and then select **Printer** from the **Hardware and Sound** category.

Windows XP:

Click **Start** and select **Control Panel**, and then select **Printers and Faxes**, from the **Printers and Other Hardware** category.

Printing

- 2** **Windows 7 and Vista:**
Click the **Add a printer** button.

Windows XP:

Click the **Add a printer** button. The Add Printer Wizard appears. Click the **Next** button.

- 3** **Windows 7 and Vista:**
Click **Add a network, wireless or Bluetooth printer**, and then click **Next**.

Windows XP:

Select **A network printer, or a printer attached to another computer**, then click **Next**.

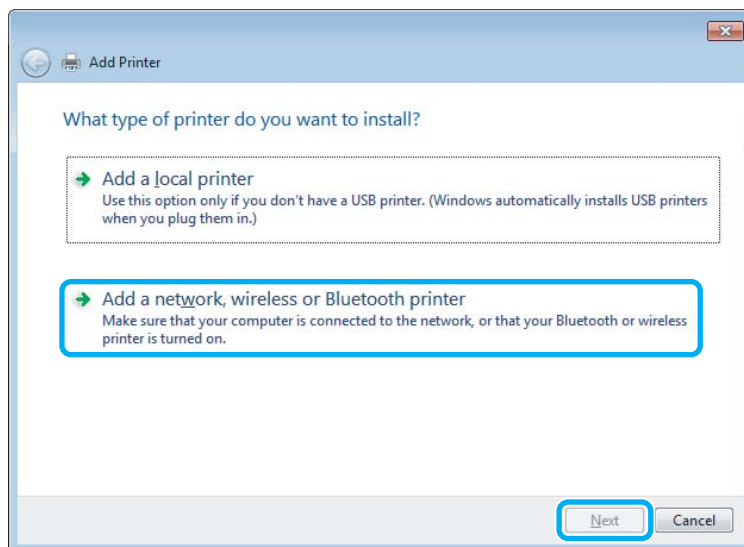

- 4** Follow the on-screen instructions to select the product you want to use.

Note:

Depending on the operating system and the configuration of the computer to which the product is connected, the Add Printer Wizard may prompt you to install the printer driver from the product software disk. Click the **Have Disk** button and follow the on-screen instructions.

Setup for Mac OS X

To set up your product on a Mac OS X network, use the Printer Sharing setting. See your Macintosh documentation for details.

Scanning

Let's Try Scanning

Starting a Scan

Let's scan a document to get used to the process.

- 1 Place your original(s) on the scanner glass.
➔ [“Placing Originals” on page 22](#)
- 2 Start Epson Scan.
 - Windows:
Double-click the **Epson Scan** icon on the desktop.
 - Mac OS X:
Select **Applications > Epson Software > EPSON Scan**.
- 3 Select **Home Mode**.

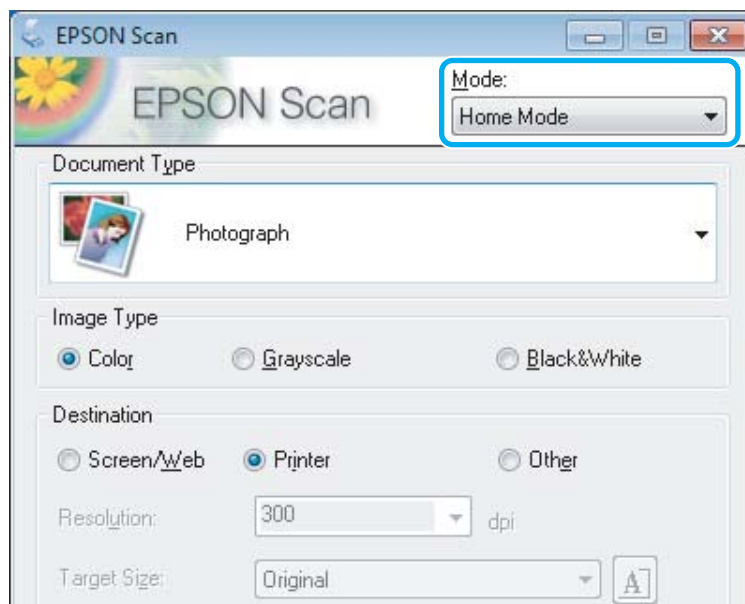

Scanning

4 Select **Text/Line Art** as the **Document Type** setting.

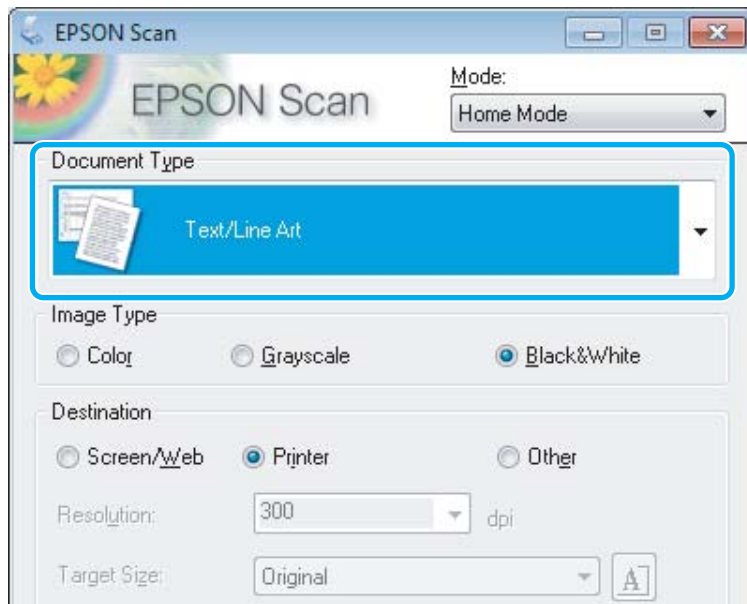

5 Click **Preview**.

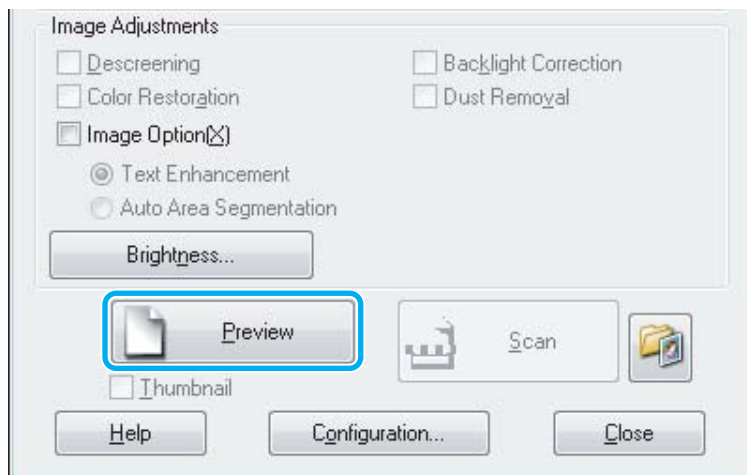

6 Click **Scan**.

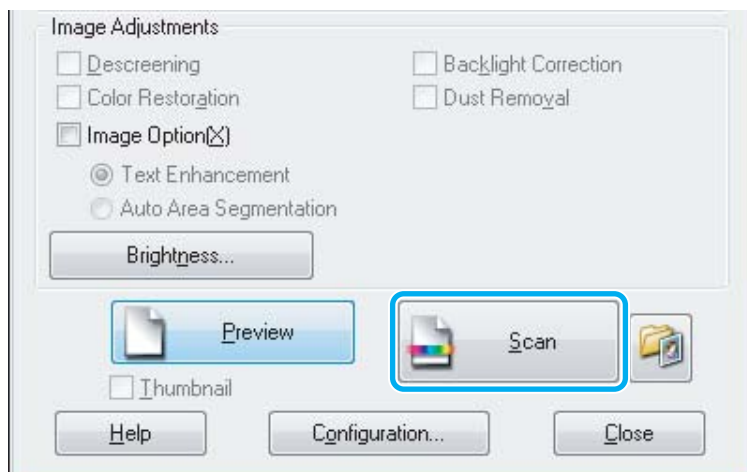

Scanning

7 Click OK.

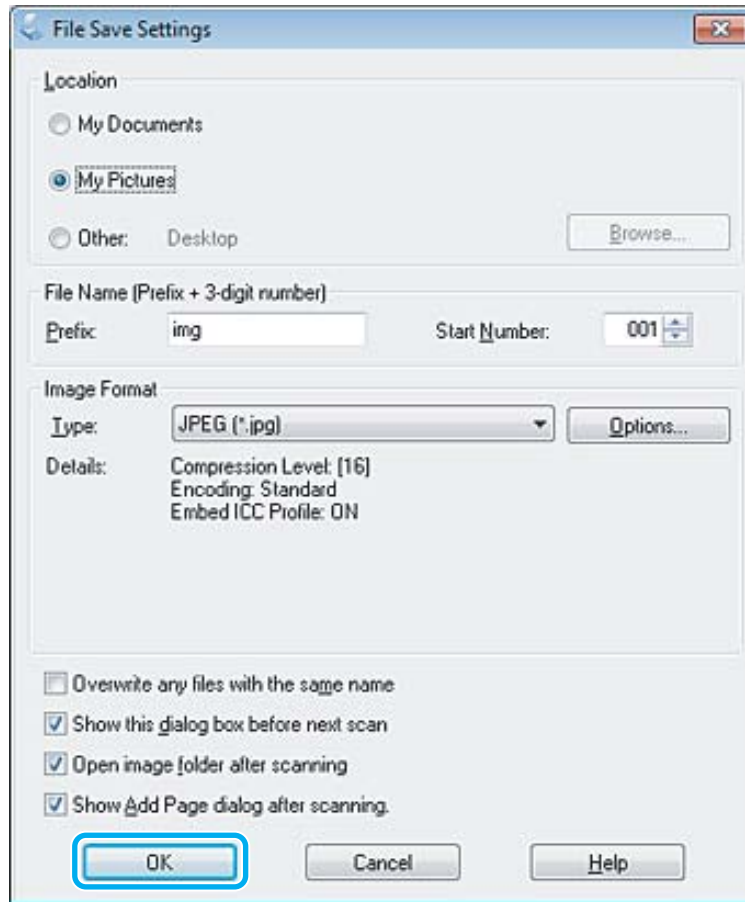

Your scanned image is saved.







Image Adjustment Features

Epson Scan offers a variety of settings for improving color, sharpness, contrast, and other aspects affecting image quality.





See the Help for more details on Epson Scan.

Histogram	<p>Provides a graphical interface for adjusting highlight, shadow, and gamma levels individually.</p> 
-----------	--

Scanning

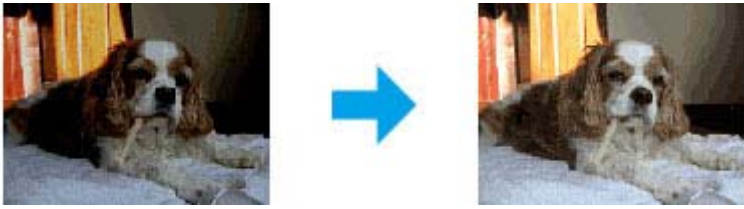
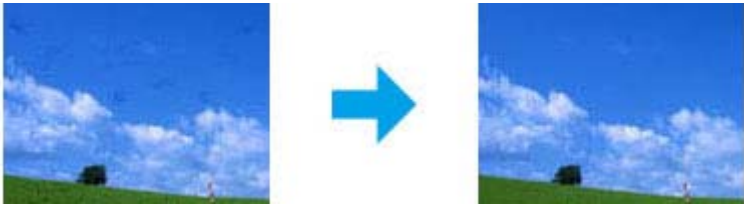
<p>Tone Correction</p>	<p>Provides a graphical interface for adjusting tone levels individually.</p> 
<p>Image Adjustment</p>	<p>Adjusts brightness and contrast and the balance of red, green, and blue colors in the overall image.</p> 
<p>Color Palette</p>	<p>Provides a graphical interface for adjusting mid-tone levels, such as skin tones, without affecting the highlight and shadow areas of the image.</p> 
<p>Unsharp Mask</p>	<p>Sharpens the edges of image areas for an overall clearer image.</p> 
<p>Descreening</p>	<p>Removes rippled patterns (known as moiré) that can appear in subtly shaded image areas such as skin tones.</p> 
<p>Color Restoration</p>	<p>Restores the colors in faded photos automatically.</p> 

Scanning



<p>Backlight Correction</p>	<p>Removes shadows from photos that have too much background light.</p> 
<p>Dust Removal</p>	<p>Removes dust marks from your originals automatically.</p> 
<p>Text Enhancement</p>	<p>Enhances text recognition when scanning text documents.</p> 
<p>Auto Area Segmentation</p>	<p>Makes Black&White images clearer and text recognition more accurate by separating the text from the graphics.</p> 
<p>Color Enhance</p>	<p>Enhance a certain color. You can select from red, blue, or green.</p> 

Basic Scanning from the Control Panel

You can scan documents and send the scanned image from the product to a connected computer. Make sure you have installed software for the product on your computer and connected to the computer.

- 1 Place your original(s) in the Automatic Document Feeder or on the scanner glass.
 ➔ [“Placing Originals” on page 22](#)

Scanning

- 2 Press  to enter the scan mode.
- 3 Select a scan menu item. Use  or  to select a menu, and press **OK**.
➔ [“Scan Mode” on page 76](#)
- 4 Select your computer.

Note:

- If the product is connected to a network, you can select the computer to which you want to save the scanned image.*
- You can change the computer name displayed on the control panel using Epson Event Manager.*

- 5 Press **OK** to start scanning.

Your scanned image is saved.

Scan mode menu list

Refer to the section below for the Scan mode menu list.

➔ [“Scan Mode” on page 76](#)

Basic Scanning from Your Computer

Scanning in Home Mode

Home Mode lets you customize some scanning settings and check the changes you have made in a preview image. This mode is useful for basic scanning of photos and graphics.

Note:

- In Home Mode, you can only scan from the scanner glass.*
- See the Help for more details on Epson Scan.*

- 1 Place your original(s).
➔ [“Scanner glass” on page 24](#)
- 2 Start Epson Scan.
➔ [“Starting Epson Scan Driver” on page 59](#)

Scanning

- 3 Select **Home Mode** from the Mode list.

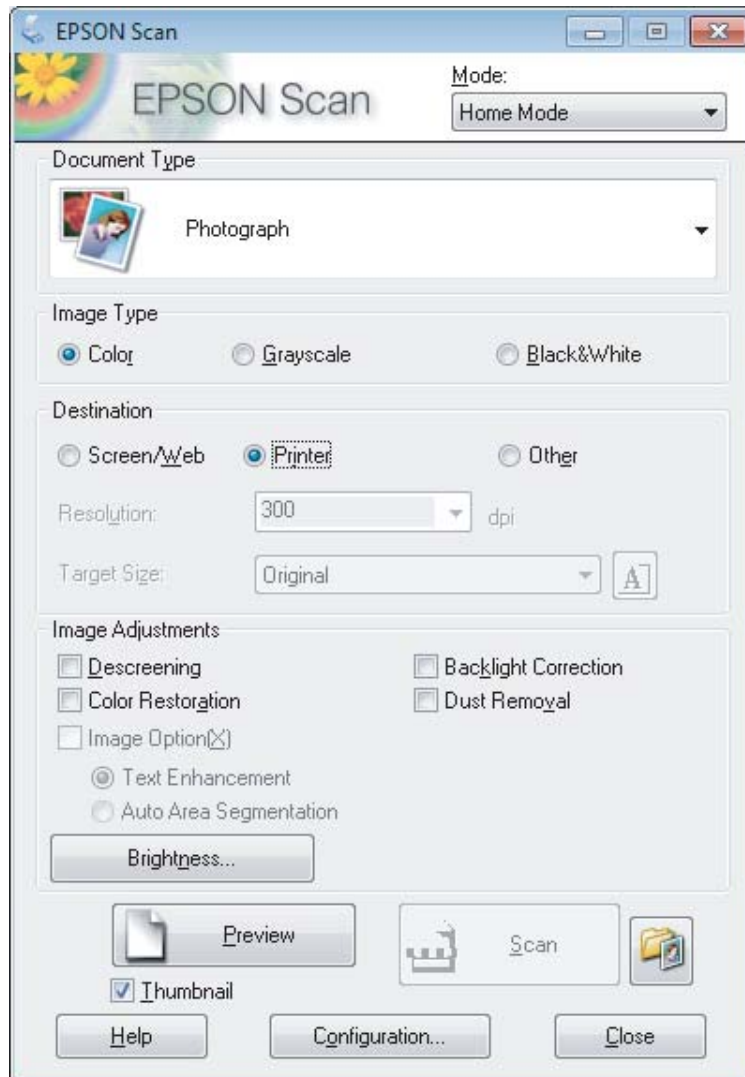

- 4 Select the Document Type setting.
- 5 Select the Image Type setting.
- 6 Click **Preview**.
 ➔ [“Previewing and Adjusting the Scan Area” on page 52](#)
- 7 Adjust the exposure, brightness, and other image quality settings.
- 8 Click **Scan**.

Scanning

- 9** In the File Save Settings window, select the Type setting and then click **OK**.

Note:

If the **Show this dialog box before next scan** check box is cleared, Epson Scan starts scanning immediately without displaying the File Save Settings window.

Your scanned image is saved.

Scanning in Office Mode

Office Mode lets you quickly scan text documents without previewing your image.

Note:

See the *Help* for more details on Epson Scan.

- 1** Place your original(s).
➔ [“Placing Originals” on page 22](#)

Note for the Automatic Document Feeder (ADF):

- If you are using preview function, load only the first page.
- Do not load paper above the line just under the ▼ arrow mark on the ADF.

- 2** Start Epson Scan.
➔ [“Starting Epson Scan Driver” on page 59](#)

Scanning

- 3 Select **Office Mode** from the Mode list.

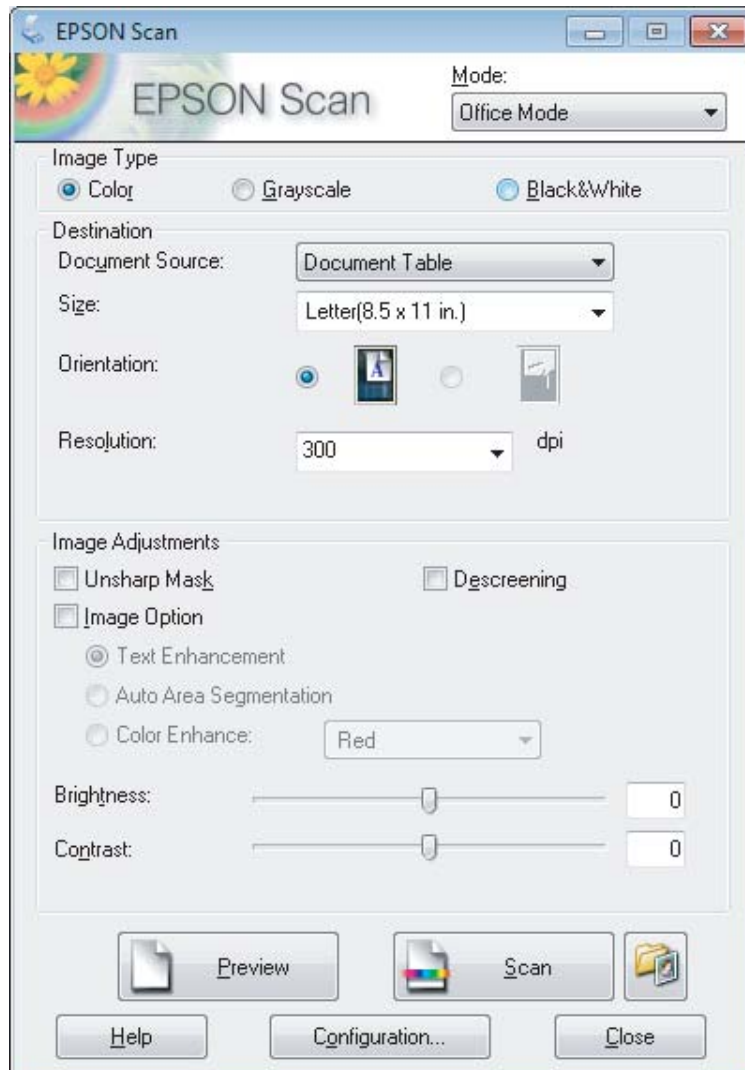

- 4 Select the Image Type setting.
- 5 Select the Document Source setting.
- 6 Select the size of your original as the Size setting.
- 7 Select an appropriate resolution for your original(s) as the Resolution setting.
- 8 Click **Scan**.

Scanning

- 9 In the File Save Settings window, select the Type setting and then click **OK**.

Note:

If the **Show this dialog box before next scan** check box is cleared, Epson Scan starts scanning immediately without displaying the File Save Settings window.

Your scanned image is saved.

Scanning in Professional Mode

Professional Mode gives you total control of your scanning settings and lets you check the changes you have made in a preview image. This mode is recommended for advanced users.

Note:

See the Help for more details on Epson Scan.

- 1 Place your original(s).
➔ [“Placing Originals” on page 22](#)

Note for the Automatic Document Feeder(ADF):

If you are using preview function, load only the first page.

- 2 Start Epson Scan.
➔ [“Starting Epson Scan Driver” on page 59](#)

Scanning

- 3 Select **Professional Mode** from the Mode list.

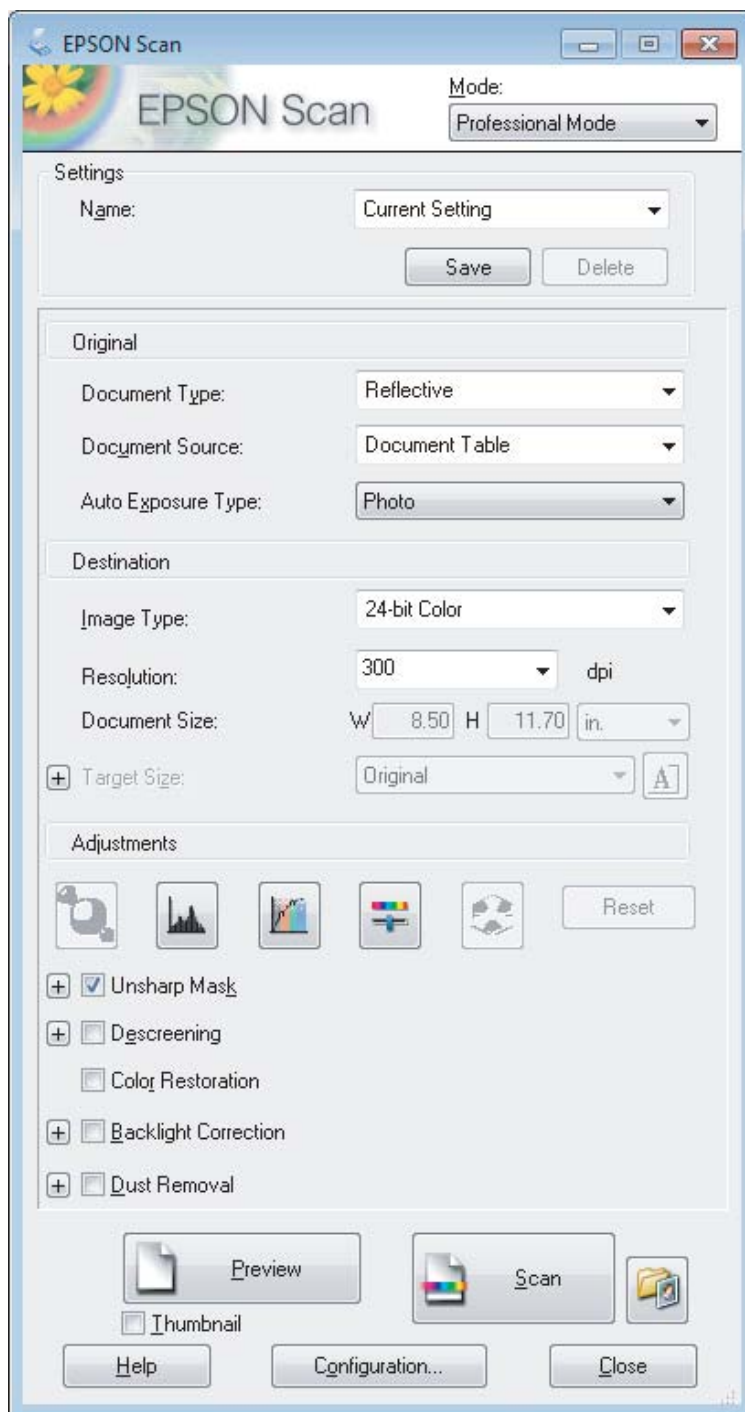

- 4 Select the type of original(s) you are scanning as the Document Type setting.

- 5 Select the Document Source setting.

- 6 If you select **Reflective** as the Document Type setting, select **Photo** or **Document** as the Auto Exposure Type setting.

Scanning

- 7 Select the Image Type setting.
- 8 Select an appropriate resolution for your original(s) as the Resolution setting.
- 9 Click **Preview** to preview your image(s). The Preview window opens and displays your image(s).
➔ [“Previewing and Adjusting the Scan Area” on page 52](#)

Note for the Automatic Document Feeder (ADF):

- The ADF loads your first document page, and then Epson Scan prescans it and displays it in the Preview window. The ADF then ejects your first page.
Place your first document page on top of the rest of the pages, and then load the entire document into the ADF.
- Do not load paper above the line just under the ▼ arrow mark on the ADF.

- 10 Select the size of the scanned image(s) as the Target Size setting if necessary. You can scan your images at their original size, or you can reduce or enlarge their size by selecting Target Size.
- 11 Adjust the image quality if necessary.
➔ [“Image Adjustment Features” on page 43](#)

Note:

You can save the settings you make as a group of custom settings with a **Name**, and later apply these custom settings when scanning. Your custom settings are also available in Epson Event Manager.
See the Help for more details on Epson Event Manager.

- 12 Click **Scan**.
- 13 In the File Save Settings window, select the Type setting and then click **OK**.

Note:

If the **Show this dialog box before next scan** check box is cleared, Epson Scan starts scanning immediately without displaying the File Save Settings window.

Your scanned image is saved.

Previewing and Adjusting the Scan Area

Selecting a preview mode

Once you have selected your basic settings and resolution, you can preview your image and select or adjust the image area in a Preview window. There are two types of preview.

- Normal preview displays your previewed image(s) in their entirety. You can select the scan area and make any image quality adjustments manually.
- Thumbnail preview displays your previewed image(s) as thumbnail(s). Epson Scan automatically locates the edges of your scan area, applies automatic exposure settings to the image(s), and rotates the image(s) if necessary.

Scanning

Note:

- ❑ Some of the settings that you change after previewing an image are reset if you change the preview mode.
- ❑ Depending on your document type and the Epson Scan mode you are using, you may not be able to change the preview type.
- ❑ If you preview image(s) without the Preview dialog displayed, image(s) are displayed in the default preview mode. If you preview with the Preview dialog displayed, image(s) are displayed in the preview mode that was displayed just before previewing.
- ❑ To resize the Preview window, click and drag the corner of the Preview window.
- ❑ See the Help for more details on Epson Scan.

Creating a marquee

A marquee is a moving dotted line that appears on the edges of your preview image to indicate the scan area.

Do one of the following to draw a marquee.



- ❑ To draw the marquee manually, position the pointer in the area where you want to place the corner of your marquee and click. Drag the cross-hairs over the image to the opposite corner of the desired scan area.





- ❑ To draw the marquee automatically, click the  auto locate icon. You can only use this icon when you are viewing a normal preview and you only have one document on the scanner glass.
- ❑ To draw the marquee at a specified size, type in a new width and height in the Document Size setting.
- ❑ For best results and image exposure, make sure all sides of the marquee are located inside the preview image. Do not include any areas around the preview image in the marquee.

Adjusting a marquee

You can move the marquee and adjust its size. If you are viewing a normal preview, you can create multiple marquees (up to 50) on each image to scan different image areas as separate scan files.

	To move the marquee, position your cursor inside the marquee. The pointer becomes a hand. Click and drag the marquee to the desired location.
	To resize the marquee, position your cursor over the edge or corner of the marquee. The pointer becomes a straight or angled double-arrow. Click and drag the edge or corner to the desired size.

Scanning

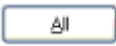
	To create additional marquees of the same size, click this icon.
	To delete a marquee, click inside the marquee and click this icon.
	To activate all marquees, click this icon.

Note:

- To restrict the movement of the marquee to vertical or horizontal only, hold down the **Shift** key as you move the marquee.
- To restrict the size of the marquee to the current proportions, hold down the **Shift** key as you resize the marquee.
- If you draw multiple marquees, make sure you click **All** in the Preview window before you scan. Otherwise, only the area inside the last marquee you drew will be scanned.

Various Types of Scanning

Scanning a Magazine

First of all, place your magazine and start Epson Scan.

➔ “Starting a Scan” on page 41

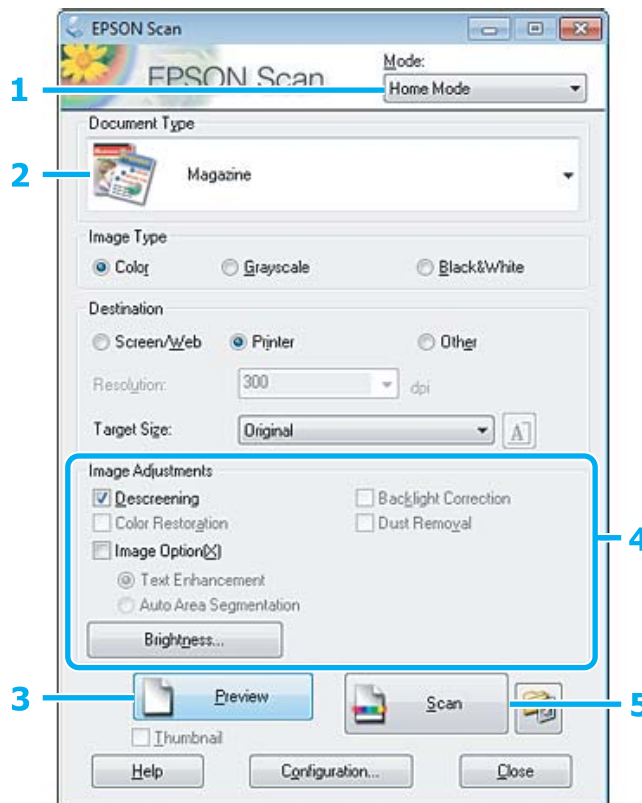

- 1** Select **Home Mode** from the Mode list.

Scanning

- 2 Select **Magazine** as the Document Type setting.
- 3 Click **Preview**.
- 4 Adjust the exposure, brightness, and other image quality settings.
See the Help for more details on Epson Scan.
- 5 Click **Scan**.

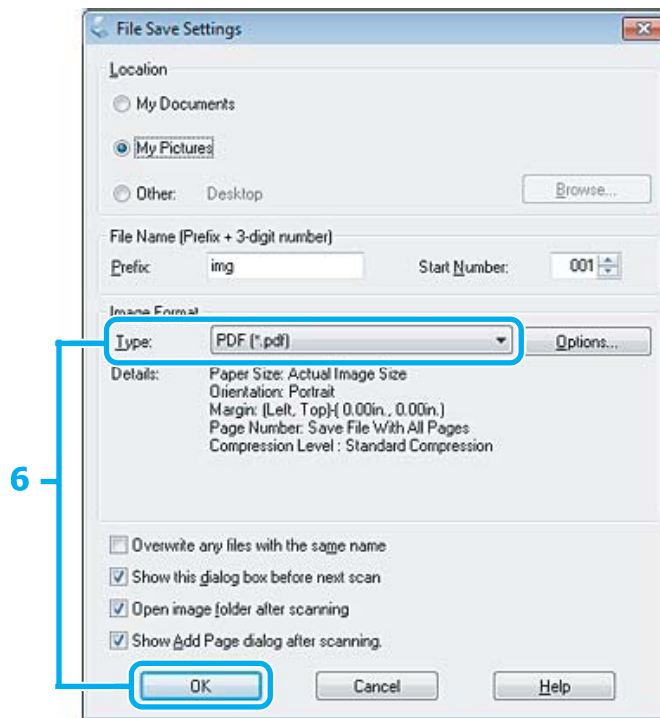

- 6 Select **PDF** as the Type setting, and then click **OK**.
Your scanned image is saved.

Scanning Multiple Documents to a PDF File

First of all, place your document and start Epson Scan.

➔ [“Starting a Scan” on page 41](#)

Note for the Automatic Document Feeder(ADF):
If you are using preview function, load only the first page.

Scanning

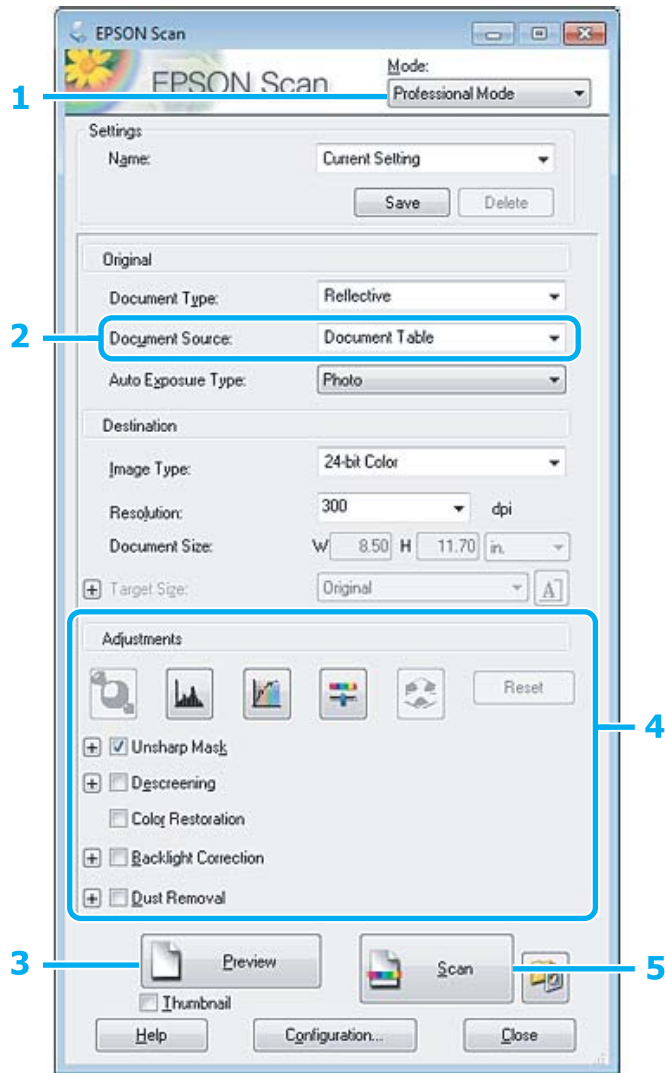

- 1 Select **Professional Mode** from the Mode list.
- 2 Select the Document Source setting.
- 3 Click **Preview**.

Note for the Automatic Document Feeder (ADF):

The document page ejected by the ADF has not been scanned yet. Reload the entire document into the ADF.

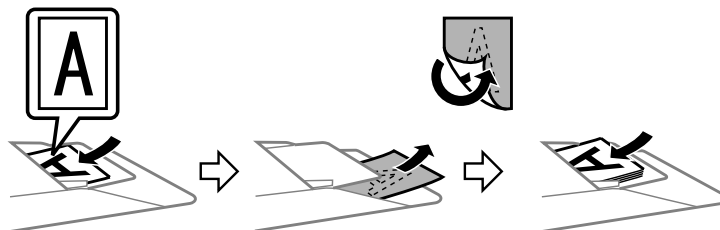

Do not load paper above the line just under the ▼ arrow mark on the ADF.

Scanning

4 Adjust the exposure, brightness, and other image quality settings.

See the Help for more details on Epson Scan.

5 Click **Scan**.

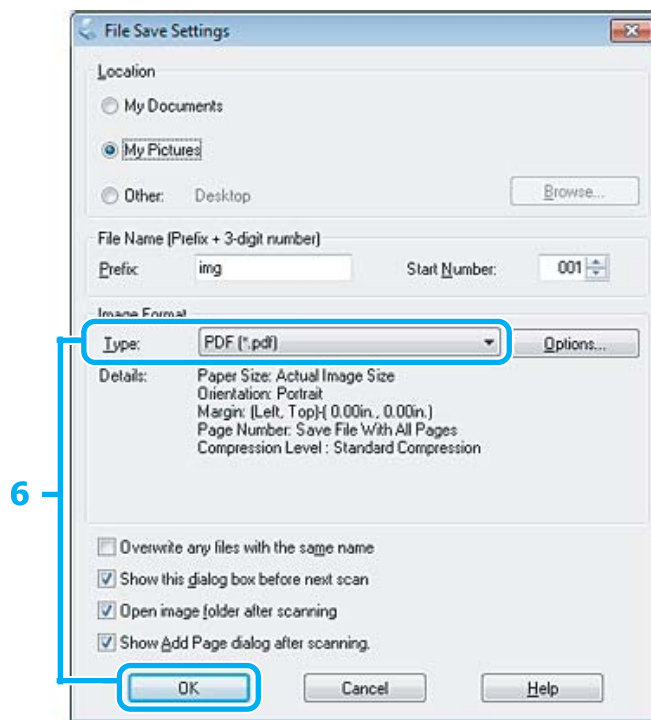

6 Select **PDF** as the Type setting, and then click **OK**.

Note:

*If the **Show Add Page dialog after scanning** check box is cleared, Epson Scan automatically saves your document without displaying the Add Page Confirmation window.*

7 Epson Scan starts scanning your document.

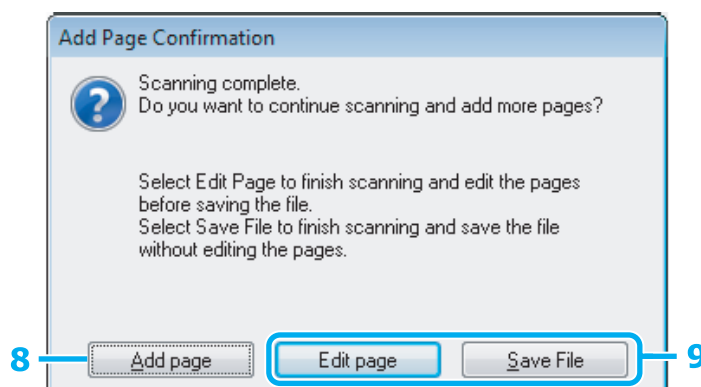

8 If you want to scan more pages, click **Add page**.
Load the document and scan again, repeating as necessary for each page.

If you have finished scanning, go to step 9.

Scanning

9 Click **Edit page** or **Save File**.

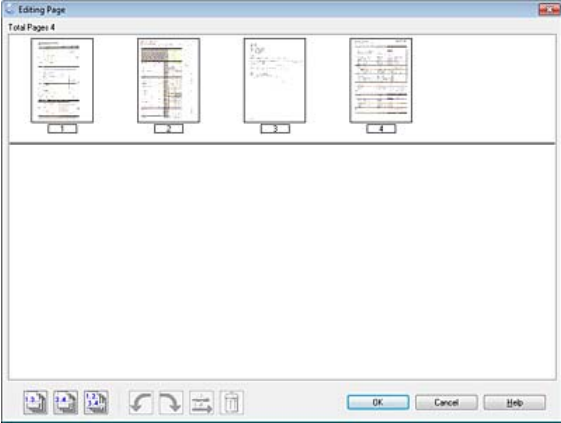
<p>Edit page</p>	<p>Select this button if you want to delete or reorder any of the pages. Then use the icons on the bottom of the Editing Page window to select, rotate, reorder, and delete pages. See the Help for more details on Epson Scan.</p>  <p>Click OK when you are finished editing your pages.</p>
<p>Save File</p>	<p>Select this button when you are finished.</p>

The pages are saved in one PDF file.

Scanning a Photo

First of all, place your photo on the scanner glass and start Epson Scan.

➔ [“Starting a Scan” on page 41](#)

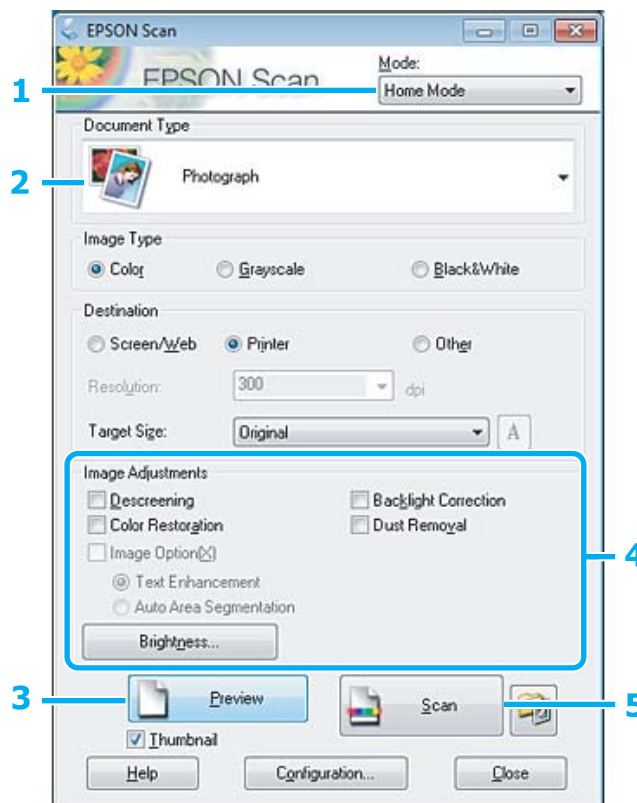

Scanning

- 1 Select **Home Mode** from the Mode list.
- 2 Select **Photograph** as the Document Type setting.
- 3 Click **Preview**.
- 4 Adjust the exposure, brightness, and other image quality settings.
See the Help for more details on Epson Scan.
- 5 Click **Scan**.

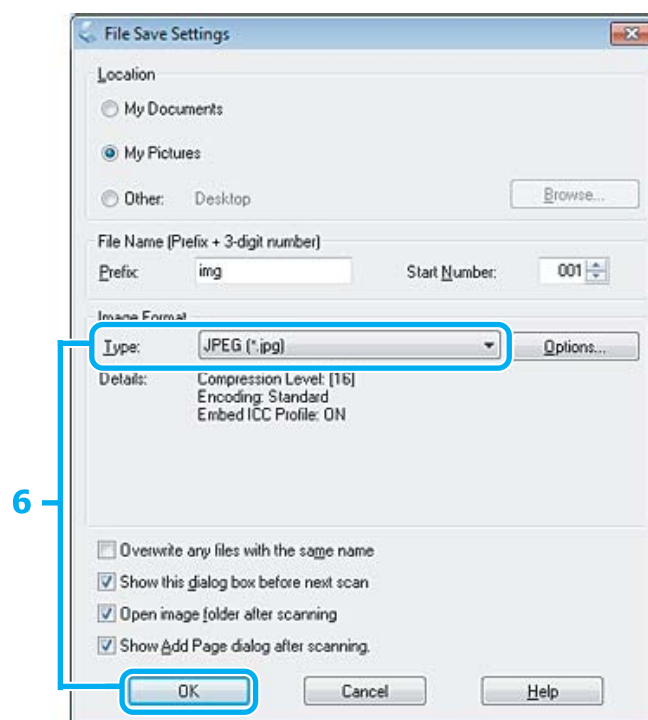

- 6 Select **JPEG** as the Type setting, and then click **OK**.

Your scanned image is saved.

Software Information

Starting Epson Scan Driver

This software lets you control all aspects of scanning. You can use this as a standalone scanning program or use it with another TWAIN-compliant scanning program.

How to start

- ❑ Windows:
Double-click the **EPSON Scan** icon on the desktop.
Or, select the start button icon or **Start > All Programs** or **Programs > EPSON > EPSON Scan > EPSON Scan**.
- ❑ Mac OS X:
Select **Applications > Epson Software > EPSON Scan**.

How to access the help

Click the **Help** button on the Epson Scan driver.

Starting Other Scanning Software

Note:

Some scanning software may not be included in some countries.

Epson Event Manager

This lets you assign any of the product buttons to open a scanning program. You can also save frequently used scanning settings, which can really speed up your scanning projects.

How to start

- ❑ Windows:
Select the start button or **Start > All Programs** or **Programs > Epson Software > Event Manager**.
- ❑ Mac OS X:
Select **Applications > Epson Software**, and then double-click the **Launch Event Manager** icon.

How to access the help

- ❑ Windows:
Click the  icon in the upper right corner of the screen.
- ❑ Mac OS X:
Click **menu > Help > Epson Event Manager Help**.

Faxing

Introducing FAX Utility

FAX Utility is a software capable of transmitting data such as documents, drawings, and tables created using a word processing or spreadsheet application directly by fax, without printing. Use the following procedure to run the utility.

Windows

Click the start button (Windows 7 and Vista) or click **Start** (Windows XP), point to **All Programs**, select **Epson Software**, and then click **FAX Utility**.

Mac OS X

Click **System Preference**, click **Print & Fax** or **Print & Scan**, and then select **FAX** (your product) from **Printer**. Then click as follows;

Mac OS X 10.6.x, 10.7.x: **Option & Supplies - Utility - Open Printer Utility**

Mac OS X 10.5.x: **Open Print Queue - Utility**

Note:

For more details, see the online help for FAX Utility.

Connecting to a Phone Line

About a phone cable

Use a phone cable with the following interface specification.

- RJ-11 Phone Line
- RJ-11 Telephone set connection

Depending on the area, a phone cable may be included with the product. If so, use that cable.

Using the phone line for fax only

1

Connect a phone cable leading from a telephone wall jack to the LINE port.

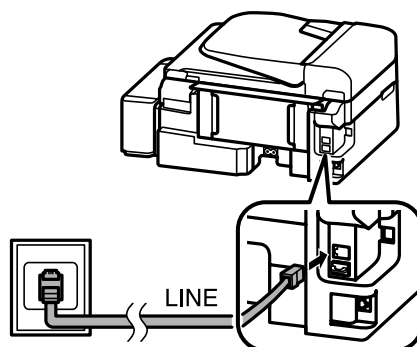

Faxing

- 2 Make sure **Auto Answer** is set to **On**.

➔ “Setting up to receive faxes automatically” on page 70

**Important:**

If you do not connect an external telephone to the product, make sure you turn on auto answer. Otherwise, you cannot receive faxes.

Sharing line with phone device

- 1 Connect a phone cable leading from a telephone wall jack to the LINE port.

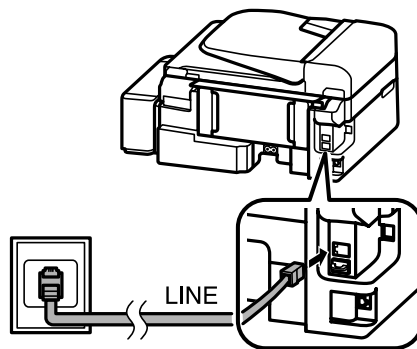

- 2 Remove the cap.

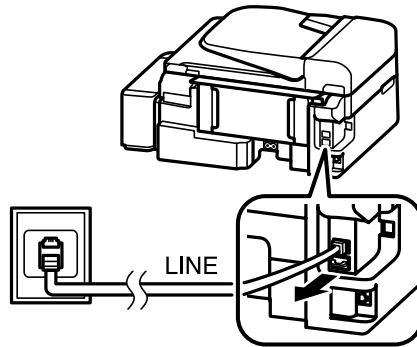

- 3 Connect a phone or answering machine to the EXT. port.

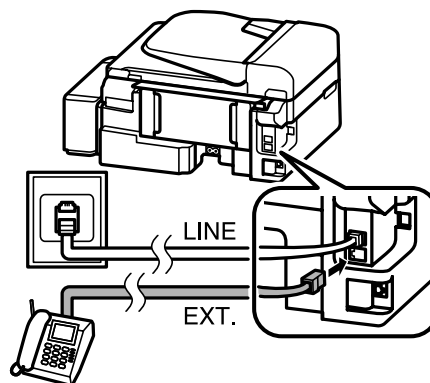

Faxing

Note:

- ❑ See the following for other connection methods.
- ❑ For details, see the documentation that came with your devices.

Connecting to DSL

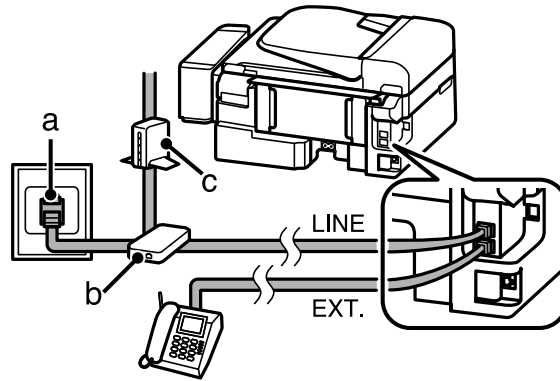

a	Telephone wall jack
b	Splitter
c	DSL modem

Connecting to ISDN (one phone number)

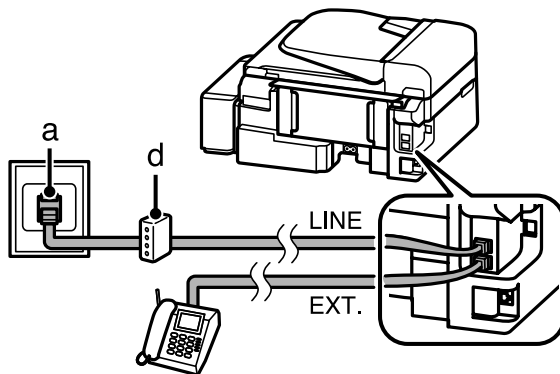

a	ISDN wall jack
d	Terminal adapter or ISDN router

Faxing



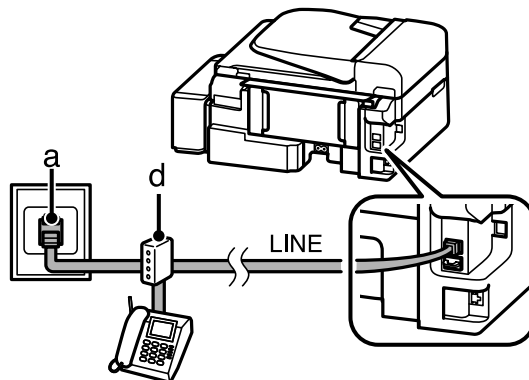

Connecting to ISDN (two phone numbers)



a	ISDN wall jack
d	Terminal adapter or ISDN router

Checking the fax connection

You can check whether the product is ready to send or receive faxes.

- 1 Load plain paper.
➔ [“Loading Paper and Envelopes” on page 19](#)
- 2 Press  to enter the fax mode.
- 3 Press  to display the menus.
- 4 Select **Fax Settings > Check Fax Connection**. Use  or  to select a menu, and press **OK**.
- 5 Press one of the  buttons to print the report.

Note:

If an errors are reported, try the solutions in the report.

Notices when the power is turned off

When the product is turned off, the following data stored in the product's temporary memory is erased.

- Received fax data
- Fax data scheduled to be sent later
- Fax data being transmitted automatically

Faxing







Also, when the power is left off for an extended period of time, the clock may be reset. Check the clock when you turn the power back on.

If the product is turned off due to a power failure, it automatically restarts and beeps when the power is restored. If you have set to receive faxes automatically (**Auto Answer - On**), the setting is also restored. Depending on the circumstances before the power failure, it may not restart.



Setting Up Fax Features

Setting up speed dial entries

You can create a speed dial list allowing you to select fax recipient numbers quickly when faxing. Up to 60 combined speed dial and group dial entries can be registered.

- 1 Press  to enter the fax mode.
- 2 Press  to display the menus.
- 3 Select the menu shown below. Use  or  to select a menu, and press **OK**.
Select **Fax Settings > Speed Dial Setup**.
- 4 Select **Create**. You see the available speed dial entry numbers.
- 5 Select the speed dial entry number that you want to register. Use  or  to select a number, and press **OK**. You can register up to 60 entries.
- 6 Use the numeric keypad to enter a phone number, and press **OK**. You can enter up to 64 digits.

Note:

- Press  to enter a space. Press  to delete numbers. Press  to enter a hyphen (-).
- A hyphen ("-") causes a slight pause when dialing. Only include it in phone numbers when a pause is necessary. Spaces entered between numbers are ignored when dialing.

- 7 Enter a name to identify the speed dial entry. You can enter up to 30 characters.
Press **OK** to register the name.

Setting up group dial entries

You can add speed dial entries to a group, allowing you to send a fax to multiple recipients at the same time. Up to 60 combined speed dial and group dial entries can be entered.

- 1 Press  to enter the fax mode.

Faxing

- 2 Press  to display the menus.
- 3 Select the menu shown below. Use ▲ or ▼ to select a menu, and press **OK**.
Select **Fax Settings > Group Dial Setup**.
- 4 Select **Create**. You see the available group dial entry numbers.
- 5 Select the group dial entry number that you want to register. Use ▲ or ▼ to select a number, and press **OK**.
- 6 Enter a name to identify the group dial entry. You can enter up to 30 characters.
Press **OK** to register the name.
- 7 Select a speed dial entry that you want to register in the group dial list. Use ▲ or ▼ to select the entry and do the following to add it to the group.

Press **X**. When you want to cancel the selection, press **X** again.
- 8 Repeat step 7 to add other speed dial entries to the group dial list. You can register up to 30 speed dial entries in a group dial.
- 9 Press **OK** to finish creating a group dial list.



Creating header information

You can create a fax header by adding information such as your phone number or name.

Note:

Make sure you have set the time correctly.

➔ [“Setting/Changing Time and Region” on page 87](#)

- 1 Press  to enter the fax mode.
- 2 Press  to display the menus.
- 3 Select the menu shown below. Use ▲ or ▼ to select a menu, and press **OK**.
Select **Fax Settings > Header > Fax Header**.
- 4 Enter the header information. You can enter up to 40 characters.
Press **OK** to register the name.
- 5 Press ▼ to select **Your Phone Number** and press **OK**.

Faxing

- 6** Use the numeric keypad with other buttons on the control panel to enter your phone number. You can enter up to 20 digits.

Note:

Press the # button to enter a plus sign (+) which represents the international call prefix. Note that the asterisk (*) is unavailable.

- 7** Press **OK** to register the header information.

Sending Faxes

Sending faxes by entering a number



- 1** Place your original(s) in the Automatic Document Feeder or on the scanner glass.
➔ [“Placing Originals” on page 22](#)

- 2** Press  to enter the fax mode.

- 3** Use the keys on the numeric keypad to enter the fax number. You can enter up to 64 digits.

If you want to send the fax to more than one recipient, press **OK** after entering a one fax number, and select **Yes** to add another fax number.

Note:

- To display the last fax number you used, press .
- You can change fax quality and contrast settings. When finished, press  again to return to the fax mode top screen.
Press  and select **Quality** or **Contrast**.
- Make sure you have entered the header information. Some fax machines automatically reject incoming faxes that do not include header information.

- 4** Press one of the  buttons to start sending.

Note:

If the fax number is busy or there is some problem, this product redials after one minute. Press  to redial immediately.

Sending faxes using speed dial/group dial

Follow the instructions below to send faxes using speed dial/group dial.

Note:

When using group dial, you can only send B&W faxes.

Faxing

1 Place your original(s) in the Automatic Document Feeder or on the scanner glass.
 ➔ [“Placing Originals” on page 22](#)



2 Press  to enter the fax mode.

3 Press .

Note:
 Each press of  switches between the speed dial list and group dial list.

4 Select the entry number to send. Use ▲ or ▼ to select an entry, and press OK.

You will be prompted to add another number. You can add another number by manually entering the number or using the speed dial or group dial.

Note:
 You can change fax quality and contrast settings. When finished, press  again to return to the fax mode top screen.
 Press  and select **Quality** or **Contrast**.

5 Press one of the  buttons to start sending.

Sending a fax at a specified time

Follow the instructions below to send a fax at a specified time.

Note:

- Make sure you have set the time correctly.
 ➔ [“Setting/Changing Time and Region” on page 87](#)
- You can only send B&W faxes.

1 Place your original(s) in the Automatic Document Feeder or on the scanner glass.
 ➔ [“Placing Originals” on page 22](#)

2 Press  to enter the fax mode.

3 Enter a fax number. You can also use redial, speed dial, or group dial lists to select fax number.

4 Press  to display the menus.

5 Select **Send Fax Later**. Use ▲ or ▼ to select the menu, and press OK.

Faxing

- 6 Press ▼ to select **On**.
Press ► to display the time settings.
- 7 Set the time that you want to send the fax, and then press **OK**. Use ► or ◀ to move the cursor and use ▲ or ▼ to select a.m. or p.m.
- 8 Press ↵ to return to the fax send screen.
- 9 Press the ◇ (B&W) button to start scanning. The scanned image is sent at the specified time.

Note:

If you need to cancel faxing at the time you specified, press Ⓞ.

Sending a fax from a connected phone

If the recipient has the same number for both phone and fax, you can send a fax after talking over the phone without hanging up.

- 1 Place your original(s) in the Automatic Document Feeder or on the scanner glass.
➔ [“Placing Originals” on page 22](#)
- 2 Dial a number from the phone connected to the product.

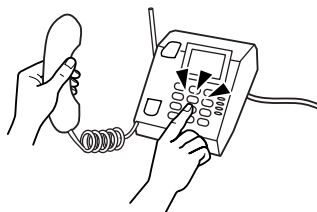



- 3 Select **Send** on the control panel of the product.
- 4 Press one of the ◇ buttons to send fax.
- 5 Hang up the phone.



Receiving Faxes





Setting up to receive faxes automatically

Follow the instructions to make settings to receive faxes automatically.

- 1 Load plain paper in the rear paper feed.
➔ [“Loading Paper and Envelopes” on page 19](#)
- 2 Press  to enter the fax mode.
- 3 Press  to display the menus.
- 4 Make sure Auto Answer is set to On.
Fax Settings > Send/Receive Setup > Auto Answer > On

Note:

- When an answering machine is connected directly to this product, make sure you set **Rings to Answer** correctly using the following procedure.
- Depending on the region, **Rings to Answer** may be unavailable.

- 5 Press  and  to select **Communication** and press **OK**.
- 6 Select **Rings to Answer** and press **OK**.
- 7 Press  or  to select the number of rings and press **OK**.

 **Important:**

Select more rings than needed for the answering machine to pick up. If it is set to pick up on the fourth ring, set the product to pick up on the fifth ring or later. Otherwise the answering machine cannot receive voice calls.

Note:

When you receive a call and the other party is a fax, the product receives the fax automatically even if the answering machine picks up the call. If you pick up the phone, wait until the LCD screen displays a message saying that a connection has been made before you hang up. If the other party is a caller, the phone can be used as normal or a message can be left on the answering machine.

Receiving faxes manually

If your phone is connected to the product, you can receive fax data after the connection is made.

Faxing

- 1 Load plain paper in the rear paper feed.
➔ [“Loading Paper and Envelopes” on page 19](#)
- 2 When the telephone rings, lift the phone connected to the product.



- 3 When you hear a fax tone, select **Receive** on the control panel of the product.
- 4 Start receiving the fax.
Select **Yes**.
- 5 Put the phone back on the hook.

Note:





If Auto Answer mode is turned on, the received fax data is automatically printed, and you do not have to proceed to step 6.

- 6 Print the received fax.
Press **OK**.

Receive a fax by polling

This allows you to receive a fax from the fax information service you have called.

Follow the instructions below to receive a fax by polling.

- 1 Load plain paper in the rear paper feed.
➔ [“Loading Paper and Envelopes” on page 19](#)
- 2 Press  to enter the fax mode.
- 3 Enter the fax number.
- 4 Press  to display the menus.
- 5 Select the menu shown below. Use  or  to select a menu, and press **OK**.
Select **Fax Mode** > **Polling**. Press  to return to the fax mode top screen.

Faxing

- 6 Press one of the  buttons to receive the fax.





Note:

If Auto Answer mode is turned on, the received fax data is automatically printed, and you do not have to proceed to step 7.

- 7 Print the received fax.
Press **OK**.

Printing Reports

Follow the instructions below to print a fax report.

- 1 Load plain paper in the rear paper feed.
➔ [“Loading Paper and Envelopes” on page 19](#)
- 2 Press  to enter the fax mode.
- 3 Press  to display the menus.
- 4 Select the menu shown below. Use  or  to select a menu, and press **OK**.
Select **Fax Settings > Print Report**.
- 5 Select the item you want to print.

Note:

Only **Fax Log** can be viewed on the screen.

- 6 Press one of the  buttons to print the report you selected.

Fax Mode Menu List

Refer to the section below for the Fax mode menu list.

- ➔ [“Fax Mode” on page 74](#)

Menu List of Control Panel

You can use this product as a printer, copier, scanner, and fax. When using one of these functions, except the printer function, select your desired function by pressing the corresponding Mode button on the control panel. Each mode's main screen appears as you select the mode.

Copy Mode

Note:

Depending on the model, some functions may not be available.

Press  to see the menu.

Setting Item	Setting item and description.	
Layout	With Border, ID Card Copy	
Reduce/Enlarge	Actual Size, Auto Fit Page, Custom	
Paper Size	A4, Legal	
Paper Type	Plain Paper	
Quality	Draft, Standard Quality, Best	
Copy Density	-4 to +4	
Restore Default Settings	Reset Fax Send/Receive Settings	Initializes Fax Send/Receive settings to the factory default settings.
	Reset Fax Data Settings	Initializes Fax Data settings to the factory default settings.
	Reset Network Settings	Initializes Network settings to the factory default settings.
	Reset Wi-Fi Settings	Initializes Wi-Fi settings to the factory default settings.
	Reset All except Network & Fax Settings	Initializes all settings except for Network & Fax settings to the factory default settings.
	Reset All except Wi-Fi & Fax Settings	Initializes all settings except for Wi-Fi & Fax settings to the factory default settings.
	Reset All Settings	Initializes all settings to the factory default settings.
Wi-Fi Settings (Wi-Fi capable models only)	Wi-Fi Setup	See the online Network Guide. You can access the Wi-Fi Setup menus directly by pressing the  button.
	Check Wi-Fi Connection	You can check the network connection status, and print the report. If there is any problem with the connection, the report helps you find the solution.
	Confirm Wi-Fi Settings	You can see the current network settings.
	Print Wi-Fi Status Sheet	You can print a network status sheet.

Menu List of Control Panel

Setting Item	Setting item and description.	
Network Settings (Ethernet capable models only)	Check Network Connection	You can check the network connection status, and print the report. If there is any problem with the connection, the report helps you find the solution.
	Confirm Network Settings	You can see the current network settings.
	Print Network Status Sheet	You can print a network status sheet.
Maintenance	Nozzle Check	Prints a nozzle check pattern to check the condition of the print head.
	Head Cleaning	Cleans the print head to improve the condition of the print head.
	Head Alignment	Adjusts the alignment of the print head.
	Sound	On, Off
	LCD Contrast	+1 to +16
	Scroll Speed	Fast, Standard, Slow
	Sleep Timer	3minutes, 5minutes, 10minutes
	Date/Time	Date, Time
	Daylight Saving Time	On, Off
	Country/Region	-
	Language	-

Fax Mode

Press  to see the menu.

Menu	Setting item	Description
Quality	-	Select this option to change the quality for fax data you are sending.
Contrast	-	Select this option to change the contrast for fax data you are sending.
Send Fax Later	-	➔ "Sending a fax at a specified time" on page 68.
Fax Mode	Sending	Default mode to send faxes normally.
	Polling	➔ "Receive a fax by polling" on page 71.

Menu List of Control Panel

Menu	Setting item	Description
Fax Settings	Print Report	<p>Fax Log: Prints or displays the communication log.</p> <p>Last Transmission: Prints a communication-in log for the previous transmission or the previous polling results received.</p> <p>Speed Dial List: Prints the speed dial list.</p> <p>Group Dial List: Prints the group dial list.</p> <p>Reprint Faxes: Reprints from the latest fax received. When the memory is full, the oldest faxes are erased first.</p> <p>Protocol Trace: Prints the protocol for the latest communication.</p>
	Speed Dial Setup	➔ "Setting Up Fax Features" on page 65.
	Group Dial Setup	
	Send/Receive Setup	<p>Auto Answer: ➔ "Setting up to receive faxes automatically" on page 70.</p> <p>Quality: Select this option to change the quality for fax data you are sending.</p> <p>Contrast: Select this option to change the contrast for fax data you are sending.</p> <p>Paper Size: Indicates the size of paper used for printing received faxes and fax reports.</p> <p>Auto Reduction: Indicates whether large received faxes are reduced in size to fit on A4-size, or printed at their original size on multiple sheets.</p> <p>Last Transmission Report: Indicates whether or when the product prints a report for outgoing faxes. Select Off to turn off report printing, select On Error to print reports only when an error occurs, or select On Send to print reports for every fax you send.</p>
	Communication	<p>DRD: Indicates the type of answer ring pattern you want to use to receive faxes. To select an option other than All (or Off), you must set up your phone system to use different ring patterns. This option may be On or Off depending on the region.</p> <p>ECM: Indicates whether or not to use Error Correction Mode to automatically correct fax data sent/received with errors due to the line or any other problems. Color faxes cannot be sent/received when ECM is off.</p> <p>Fax Speed: Indicates the speed at which you transmit and receive faxes.</p> <p>Rings to Answer: Indicates the number of rings that must occur before the product automatically receives a fax. Depending on the region, this setting may not be displayed.</p> <p>Dial Tone Detection: When this is set to On, the product starts dialing after it detects a dial tone. It may not be able to detect a dial tone when a PBX (Private Branch Exchange) or a TA (Terminal Adapter) is connected. In that case, set to Off. However, doing so may drop the first digit of a fax number and send the fax to the wrong number.</p> <p>Dial Mode: Indicates the type of phone system to which you have connected the product. Depending on the region, this setting may not be displayed.</p>
	Check Fax Connection	Checks the status of your fax connection.
Header	➔ "Creating header information" on page 66.	

Menu List of Control Panel

Menu	Setting item	Description
Restore Default Settings	-	➔ "Copy Mode" on page 73.
Wi-Fi Settings	-	
Network Settings	-	
Maintenance	-	

Scan Mode

Note:

Depending on the model, some functions may not be available.

Menu	Setting and Options
Scan to PC	➔ "Basic Scanning from the Control Panel" on page 45
Scan to PC (PDF)	
Scan to PC (Email)	
Scan to PC (WSD)	This feature is only available for English versions of Windows 7/Vista.

Press  to see the menu.

Menu	Description
Restore Default Settings	➔ "Copy Mode" on page 73.
Wi-Fi Settings	
Network Settings	
Maintenance	

Refilling Ink

Ink Bottle Safety Instructions, Precautions, and Specifications

Safety instructions

Observe the following when handling the ink:

- Keep ink bottles and the ink tank unit out of the reach of children. Do not allow children to drink from or handle the ink bottles and ink bottle cap.
- Do not tilt or shake an ink bottle after removing its seal; this can cause leakage.
- Be careful not to touch any ink when you handle the ink tanks, ink tank caps, and opened ink bottles or ink bottle caps.
If ink gets on your skin, wash the area thoroughly with soap and water.
If ink gets into your eyes, flush them immediately with water. If discomfort or vision problems continue after a thorough flushing, see a doctor immediately.
If ink gets into your mouth, spit it out immediately and see a doctor right away.

Precautions on refilling ink

Read all of the instructions in this section before refilling ink.

- Use ink bottles with the correct part number for this product.
➔ [“Ink Bottles” on page 125](#)
- Epson recommends the use of genuine Epson ink bottles. Epson cannot guarantee the quality or reliability of non-genuine ink. The use of non-genuine ink may cause damage that is not covered by Epson's warranties, and under certain circumstances, may cause erratic product behavior.
- Other products not manufactured by Epson may cause damage that is not covered by Epson's warranties, and under certain circumstances, may cause erratic product behavior.
- This product requires careful handling of ink. Ink may splatter when the ink tanks are filled or refilled with ink. If ink gets on your clothes or belongings, it may not come off.
- To maintain optimum print head performance, some ink is consumed from all ink tanks not only during printing but also during maintenance operation such as print head cleaning.
- Do not open the ink bottle package until you are ready to fill the ink tank. The ink bottle is vacuum packed to maintain its reliability. If you leave an ink bottle unpacked for a long time before using it, normal printing may not be possible.

Refilling Ink

- ❑ Do not continue printing when the ink level is below the lower limit on the ink tank. Continued use of the product when the ink level is below the lower limit could damage the product. Epson recommends filling all ink tanks to the upper line when the product is not operating to reset the ink levels. If the ink tank is filled as specified above, this product provides an alert and stops operating at the estimated time so that the ink levels do not fall below the lower limit on the ink tank.
- ❑ After bringing an ink bottle inside from a cold storage site, allow it to warm up at room temperature for at least three hours before using it.
- ❑ Store ink bottles in a cool, dark place.
- ❑ Store the ink bottles in the same environment as the product. When storing or transporting an ink bottle after removing its seal, do not tilt the bottle and do not subject it to impacts or temperature changes. Otherwise, ink may leak even if the cap on the ink bottle is tightened securely. Be sure to keep the ink bottle upright when tightening the cap, and take measures to prevent ink from leaking when you transport the bottle.

Ink bottle specifications

- ❑ Epson recommends using the ink bottle before the date printed on the package.
- ❑ The ink bottles packaged with your product are partly used during initial setup. In order to produce high quality printouts, the print head in your product will be fully charged with ink. This one-off process consumes a quantity of ink and therefore these bottles may print fewer pages compared to subsequent ink bottles.
- ❑ Quoted yields may vary depending on the images that you are printing, the paper type that you are using, the frequency of your prints and environmental conditions such as temperature.
- ❑ To ensure you receive premium print quality and to help protect your print head, a variable ink safety reserve remains in the ink tank when your product indicates to refill ink. The yields quoted for you do not include this reserve.
- ❑ Although the ink bottles may contain recycled materials, this does not affect product function or performance.
- ❑ When printing in monochrome or grayscale, color inks instead of black ink may be used depending on the paper type or print quality settings. This is because a mixture of color inks is used to create black.

Checking the Ink Levels

To confirm the actual ink remaining, visually check the ink levels in the product's ink tanks.

**Important:**

If the ink level is below the lower limit on the ink tank, fill it to the upper line on the ink tank. Continued use of the product when the ink level is below the lower limit on the tank could damage the product.

Refilling the Ink Tanks

Note:

The illustrations show how to refill the cyan ink. However, the instructions are the same for all of the inks.

Refilling Ink

- 1 Make sure the  light is on, but not flashing.
- 2 Unhook the ink tank unit from the product and lay it down.

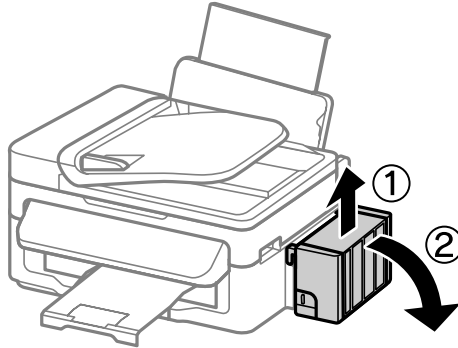

Note:
Do not pull the tubes.

- 3 Open the ink tank unit cover, and then remove the cap of the ink tank.

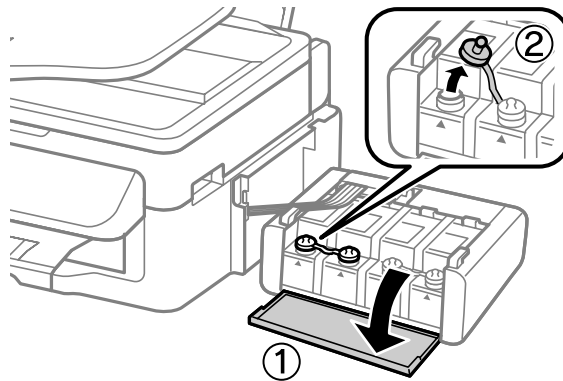

Note:

- Be careful not to spill any ink.
- Make sure that the color of the ink tank matches the ink color that you want to refill.

- 4 Snap off the top of the cap, remove the cap of the ink bottle, remove the seal from the bottle, and then install the cap.

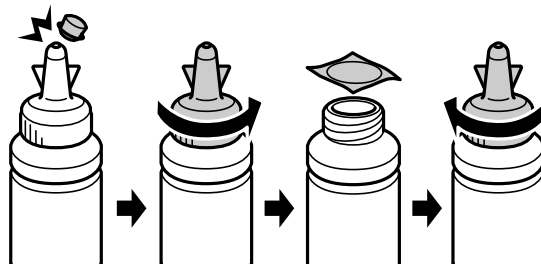

Refilling Ink

! **Important:**
Install the ink bottle cap tightly; otherwise ink may leak.

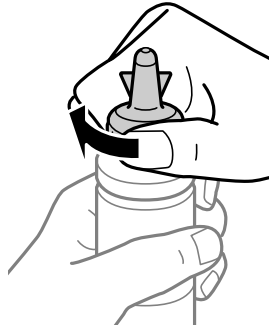

Note:
Do not dispose of the top of the cap. If any ink remains in the ink bottle after refilling the tank, use the top of the cap to seal the ink bottle cap.

5

Refill the ink tank with the correct colored ink up to the upper line on the ink tank.

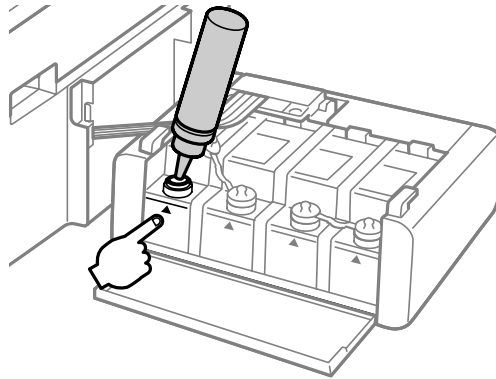

Note:
If any ink remains in the ink bottle after filling the ink tank up to the upper line, install the cap securely and store the ink bottle upright for later use.

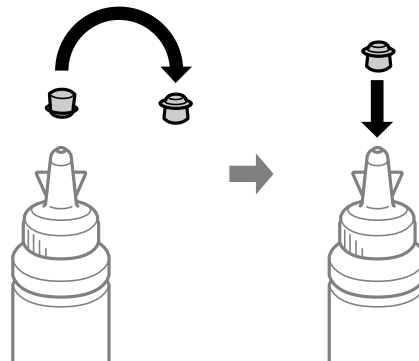

Refilling Ink

- 6 Install the cap onto the ink tank securely.

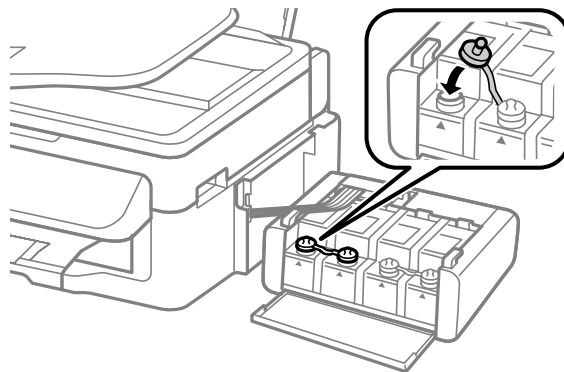

- 7 Repeat steps 3 to 6 for each ink bottle.

- 8 Close the ink tank unit cover.

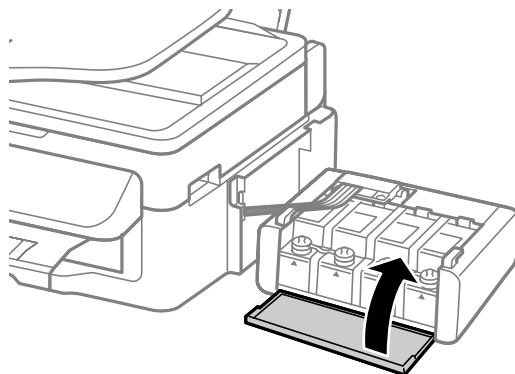

- 9 Hook the ink tank unit onto the product.

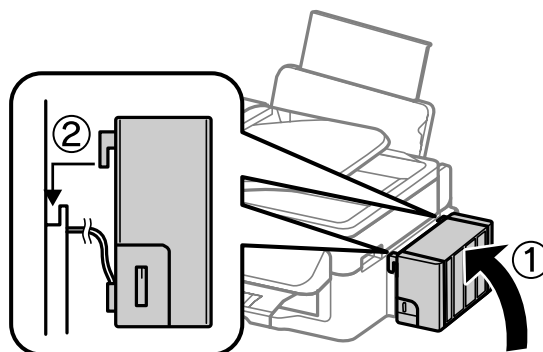

Note:

- ❑ If the product indicates that ink levels must be reset, follow the on-screen instructions.
- ❑ Even if you do not have new ink bottles and one or more ink tanks are not filled up to the upper line on the ink tank, you can continue using the product. To keep your product operating at its best, however, fill all ink tanks with ink up to the upper line immediately.

Maintaining Your Product and Software

Checking the Print Head Nozzles

If you find that the printout is unexpectedly faint or that dots are missing, you may be able to identify the problem by checking the print head nozzles.

You can check the print head nozzles from your computer by using the Nozzle Check utility or from the product by using the buttons.

Using the Nozzle Check utility for Windows

Follow the steps below to use the Nozzle Check utility.

- 1 Make sure that no warnings or errors are indicated in the control panel.
- 2 Make sure that A4-size paper is loaded in the rear paper feed.
- 3 Right-click the product icon on the taskbar, then select **Nozzle Check**.
If the product icon does not appear, refer to the following section to add the icon.
➔ [“From the shortcut icon on the taskbar” on page 28](#)
- 4 Follow the on-screen instructions.

Using the Nozzle Check utility for Mac OS X

Follow the steps below to use the Nozzle Check utility.

- 1 Make sure that no warnings or errors are indicated in the control panel.
- 2 Make sure that A4-size paper is loaded in the rear paper feed.
- 3 Access the Epson Printer Utility 4.
➔ [“Accessing the printer driver for Mac OS X” on page 28](#)
- 4 Click the **Nozzle Check** icon.
- 5 Follow the on-screen instructions.

Using the control panel

Follow the steps below to check the print head nozzles using the product control panel.

- 1 Make sure that no warnings or errors are indicated in the control panel.
- 2 Make sure that A4-size paper is loaded in the rear paper feed.
- 3 Press  to display the menus.
- 4 Select **Maintenance**.
- 5 Select **Nozzle Check** and follow the instructions in the LCD screen to print a nozzle check pattern.

Below are two sample nozzle check patterns.

Compare the quality of the printed check page with the sample shown below. If there are no print quality problems, such as gaps or missing segments in the test lines, the print head is fine.

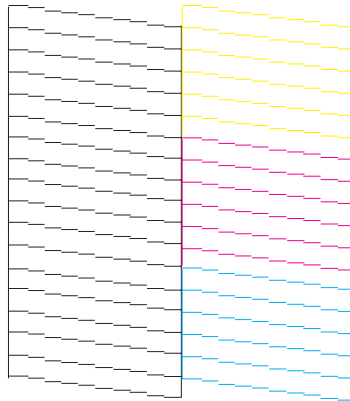

If any segment of the printed lines is missing, as shown below, this could mean a clogged ink nozzle or a misaligned print head.

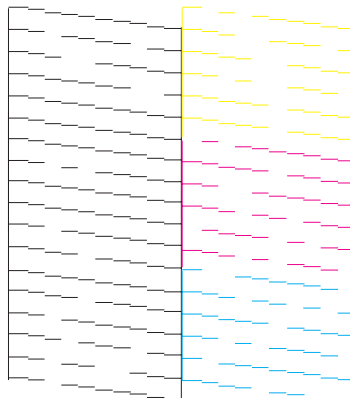

- ➔ [“Cleaning the Print Head” on page 84](#)
- ➔ [“Aligning the Print Head” on page 85](#)

Cleaning the Print Head

If you find that the printout is unexpectedly faint or that dots are missing, you may be able to solve these problems by cleaning the print head, which ensures that the nozzles are delivering ink properly.

You can clean the print head from your computer using the Head Cleaning utility in the printer driver or from the product by using the buttons.

**Important:**

Do not open the scanner unit or turn off the product during head cleaning. If the head cleaning is incomplete, you may not be able to print.

Note:

- Because print head cleaning uses some ink from all tanks, clean the print head only if quality declines; for example, if the printout is blurry or the color is incorrect or missing.*
- Use the Nozzle Check utility first to confirm that the print head needs to be cleaned. This saves ink.*
- When ink is low you may not be able to clean the print head. Prepare a new ink bottle.*
- If print quality has not improved after repeating this procedure about three times, use the Power Ink Flushing utility.
➔ [“Replacing Ink inside the Ink Tubes” on page 88](#)*
- To maintain print quality, we recommend printing a few pages on a regular basis.*

Using the Head Cleaning utility for Windows

Follow the steps below to clean the print head using the Head Cleaning utility.

- 1** Make sure that the transportation lock is set to the unlocked (Printing) position.
- 2** Make sure that no warnings or errors are indicated in the control panel.
- 3** Right-click the product icon on the taskbar, then select **Head Cleaning**.
If the product icon does not appear, refer to the following section to add the icon.
➔ [“From the shortcut icon on the taskbar” on page 28](#)
- 4** Follow the on-screen instructions.

Using the Head Cleaning utility for Mac OS X

Follow the steps below to clean the print head using the Head Cleaning utility.

- 1** Make sure that the transportation lock is set to the unlocked (Printing) position.

Maintaining Your Product and Software

- 2 Make sure that no warnings or errors are indicated in the control panel.
- 3 Access the Epson Printer Utility 4.
➔ [“Accessing the printer driver for Mac OS X” on page 28](#)
- 4 Click the **Head Cleaning** icon.
- 5 Follow the on-screen instructions.

Using the control panel

Follow the steps below to clean the print head using the product control panel.

- 1 Make sure that the transportation lock is set to the unlocked (Printing) position.
- 2 Make sure that no warnings or errors are indicated in the control panel.
- 3 Press  to display the menus.
- 4 Select **Maintenance**.
- 5 Select **Head Cleaning**.
- 6 Follow the instructions on the LCD screen to continue.

Aligning the Print Head

If you notice a misalignment of vertical lines or horizontal banding, you may be able to solve this problem by using the Print Head Alignment utility in your printer driver or by using the product buttons.

Refer to the appropriate section below.

Note:

Do not press  to cancel printing while printing a test pattern with the Print Head Alignment utility.

Using the Print Head Alignment utility for Windows

Follow the steps below to align the print head using the Print Head Alignment utility.

- 1 Make sure that no warnings or errors are indicated in the control panel.

Maintaining Your Product and Software

- 2 Make sure A4-size paper is loaded in the rear paper feed.
- 3 Right-click the product icon on the taskbar, then select **Print Head Alignment**.
If the product icon does not appear, refer to the following section to add the icon.
➔ [“From the shortcut icon on the taskbar” on page 28](#)
- 4 Follow the on-screen instructions to align the print head.

Using the Print Head Alignment utility for Mac OS X

Follow the steps below to align the print head using the Print Head Alignment utility.

- 1 Make sure that no warnings or errors are indicated in the control panel.
- 2 Make sure A4-size paper is loaded in the rear paper feed.
- 3 Access the Epson Printer Utility 4.
➔ [“Accessing the printer driver for Mac OS X” on page 28](#)
- 4 Click the **Print Head Alignment** icon.
- 5 Follow the on-screen instructions to align the print head.

Using the control panel

Follow the steps below to align the print head using the product control panel.

- 1 Make sure that no warnings or errors are indicated in the control panel.
- 2 Make sure that A4-size paper is loaded in the rear paper feed.
- 3 Press \equiv to display the menus.
- 4 Select **Maintenance**.
- 5 Select **Head Alignment** and follow the instructions in the LCD screen to print the patterns.

Maintaining Your Product and Software

- 6 Find the most solid pattern in each of #1 to #4 groups.

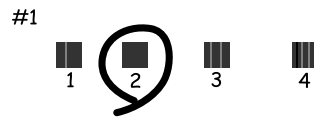

- 7 Enter the pattern number for the most solid pattern in #1 group.
- 8 Repeat step 7 for the other groups (#2 to #4).
- 9 Finish aligning the print head.

Setting/Changing Time and Region

Follow the steps below to set the time and region using the product control panel.

- 1 Press  to display the menus.
- 2 Select **Maintenance**.
- 3 Select **Date/Time**.
- 4 Select the date format.
- 5 Set the date.
- 6 Select the time format.
- 7 Set the time.

Note:
To select daylight saving time, set **Daylight Saving Time to On**.

- 8 Select **Country/Region**.
- 9 Select the region.

Maintaining Your Product and Software

10 Select **Yes**.

Note:

When the power is left off for an extended period of time, the clock may be reset. Check the clock when you turn the power back on.

Replacing Ink inside the Ink Tubes

If there is still banding or missing colors in the printouts even after running Head Cleaning several times, you may need to replace the ink inside the ink tubes to solve the problem.

The Power Ink Flushing utility allows you to replace all of the ink inside the ink tubes.



Important:

This function consumes a lot of ink. Before using this function, make sure there is enough ink in the product's ink tanks. If there is not enough ink, refill the ink tanks.

Note:

- This function consumes a lot of ink. We only recommend using this function after running Head Cleaning several times.*
- This function effects the service life of the ink pads. Ink pads reach their capacity earlier by running this function. Contact Epson Support to request replacement before the end of their service life. When the ink pads are at the end of their service life, the product stops and Epson support is required to continue printing.*
- After using the Power Ink Flushing utility, run the nozzle check again and repeat head cleaning if necessary. If print quality has still not improved, leave the product on and wait for at least six hours. If you still cannot solve the problem after trying all of the methods above, contact Epson support.*

Using the Power Ink Flushing utility for Windows

Follow the steps below to use the Power Ink Flushing utility.

- 1** Make sure that the transportation lock is set to the unlocked (Printing) position.
- 2** Make sure that no warnings or errors are indicated in the control panel.
- 3** Access the printer driver.
➔ "Accessing the printer driver for Windows" on page 29
- 4** Click the **Maintenance** tab, then click the **Power Ink Flushing** button.
- 5** Follow the on-screen instructions.

Using the Power Ink Flushing utility for Mac OS X

Follow the steps below to use the Power Ink Flushing utility.

- 1 Make sure that the transportation lock is set to the unlocked (Printing) position.
- 2 Make sure that no warnings or errors are indicated in the control panel.
- 3 Access the Epson Printer Utility 4.
➔ “Accessing the printer driver for Mac OS X” on page 30
- 4 Click the **Power Ink Flushing** icon.
- 5 Follow the on-screen instructions.

Using the control panel

Follow the steps below to use the Power Ink Flushing function.

Note:



You need to turn off the product in the following procedure. The data temporarily stored in product memory will be deleted by turning the power off.

➔ [“Notices when the power is turned off” on page 64](#)

The Power Ink Flushing utility can be used without turning the power off.

➔ [“Using the Power Ink Flushing utility for Windows” on page 88](#)

➔ [“Using the Power Ink Flushing utility for Mac OS X” on page 89](#)

- 1 Make sure that the transportation lock is set to the unlocked (Printing) position.
- 2 Make sure that no warnings or errors are indicated in the control panel.
- 3 Turn off the product.
- 4 While holding down  and , press  to turn on the product.
- 5 When the product turns on, release both the buttons.
- 6 Follow the instructions in the LCD screen.

Saving Power

The LCD screen turns black if no operations are performed for a set period.

You can adjust the time before power management is applied. Any increase will affect the product's energy efficiency. Please consider the environment before making any change.

Follow the steps below to adjust the time.

For Windows

- 1 Access the printer settings.
➔ [“Accessing the printer driver for Windows” on page 27](#)
- 2 Click the **Maintenance** tab, and then click the **Printer and Option Information** button.
- 3 Select **3 minutes**, **5 minutes**, or **10 minutes** as the Sleep Timer setting. Then click the **Send** button.
- 4 Click the **OK** button.

For Mac OS X

- 1 Access the Epson Printer Utility 4.
➔ [“Accessing the printer driver for Mac OS X” on page 28](#)
- 2 Click the **Printer Settings** button. The Printer Settings screen appears.
- 3 Select **3 minutes**, **5 minutes**, or **10 minutes** as the Sleep Timer setting.
- 4 Click the **Apply** button.

Using the control panel

- 1 Press \equiv to display the menus.
- 2 Select **Maintenance**.
- 3 Select **Sleep Timer**.
- 4 Select **3minutes**, **5minutes**, or **10minutes**.

Checking the Number of Sheets of Paper Fed

You can check the number of sheets of paper fed from the printer driver.

Click the **Printer and Option Information** button on your printer driver's Maintenance window (for Windows) or on the Epson Printer Utility 4 (for Mac OS X).

Cleaning the Product

Cleaning the exterior of the product

To keep your product operating at its best, clean it thoroughly several times a year by using the following instructions.

**Important:**

Never use alcohol or thinner to clean the product. These chemicals can damage the product.

- Use a soft, dry, clean cloth to clean the LCD screen. Do not use liquid or chemical cleaners.
- Use a soft, dry, clean cloth to clean the surface of the scanner glass.
If straight lines appear in the printout or the scanned data, clean the left side of the scanner glass carefully.

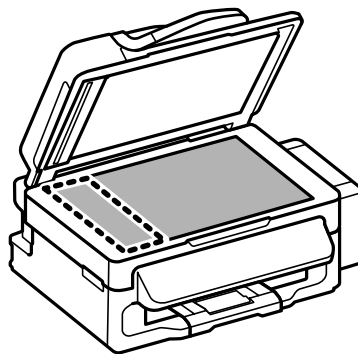

- If the glass surface is stained with grease or some other hard-to-remove material, use a small amount of glass cleaner and a soft cloth to remove it. Wipe off all remaining liquid.
- Open the ADF cover and use a soft, dry, clean cloth to clean the roller and the interior of the ADF.

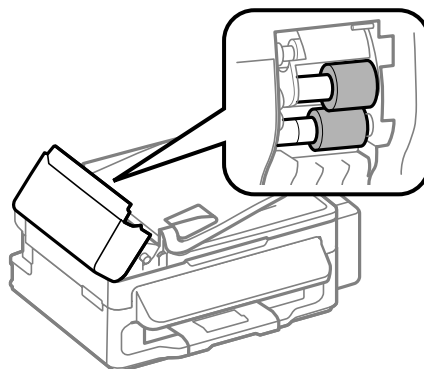

Maintaining Your Product and Software

- ❑ Do not press the surface of the scanner glass with any force.
- ❑ Be careful not to scratch or damage the surface of the scanner glass, and do not use a hard or abrasive brush to clean it. A damaged glass surface can decrease the scan quality.

Cleaning the interior of the product

To keep your print results at their best, clean the roller inside by using the following procedure.



Caution:

Be careful not to touch the parts inside the product.



Important:

- ❑ *Be careful to keep water away from the electronic components.*
- ❑ *Do not spray the inside of the product with lubricants.*
- ❑ *Unsuitable oils can damage the mechanism. Contact your dealer or a qualified service person if lubrication is needed.*

1

Make sure that no warnings or errors are indicated in the control panel.

2

Load several sheets of A4-size plain paper in the rear paper feed.

3

Press  to enter the copy mode.

4

Press one of the  buttons to make a copy without placing a document on the scanner glass.

5

Repeat step 4 until the paper is not smeared with ink.

Transporting the Product

If you move the product some distance, you need to prepare it for transportation in its original box or one of a similar size.



Important:

- ❑ *When storing or transporting the product, avoid tilting it, placing it vertically, or turning it upside down; otherwise ink may leak.*
- ❑ *When storing or transporting an ink bottle after removing its seal, do not tilt the bottle and do not subject it to impacts or temperature changes. Otherwise, ink may leak even if the cap on the ink bottle is tightened securely. Be sure to keep the ink bottle upright when tightening the cap, and take measures to prevent ink from leaking when you transport the bottle.*

1

Remove all paper from the rear paper feed and make sure the product is off.

Maintaining Your Product and Software

- 2 Close the paper support and the output tray.
- 3 Open the scanner unit and make sure the print head is in the home position on the right.

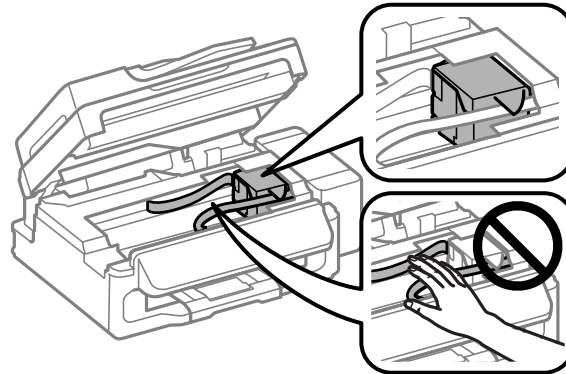

Note:

If the print head is not in the home position on the right, turn on the product and wait until the print head locks in the far right position. Then turn off the product.

- 4 Unplug the power cord from the outlet, then disconnect all cables from the product.
- 5 Secure the print head to the case with tape as shown, then close the scanner unit.

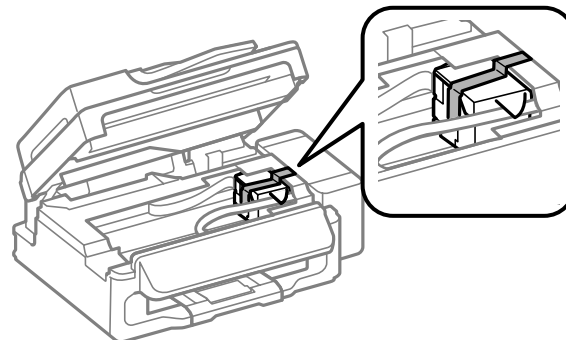

Note:

Do not place tape on the white flat cable inside the product.

- 6 Set the transportation lock to the locked (Transporting) position.

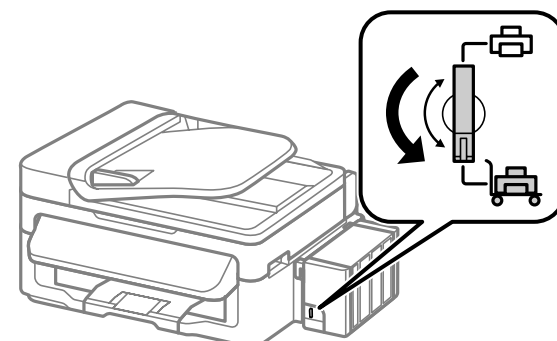

Maintaining Your Product and Software

- 7** Unhook the ink tank unit from the product and lay it down, and then make sure to install the cap onto the ink tank securely.

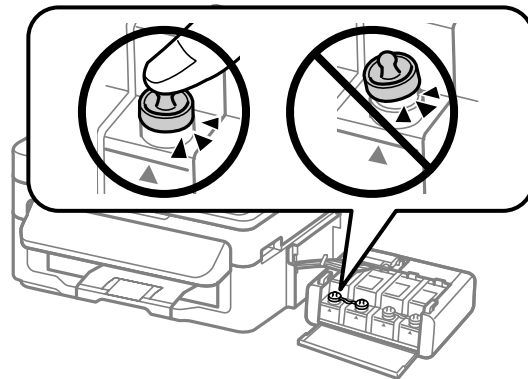

- 8** Install the covers that came with your product over the protruding parts of the ink tank, and then hook the ink tank unit onto the product.

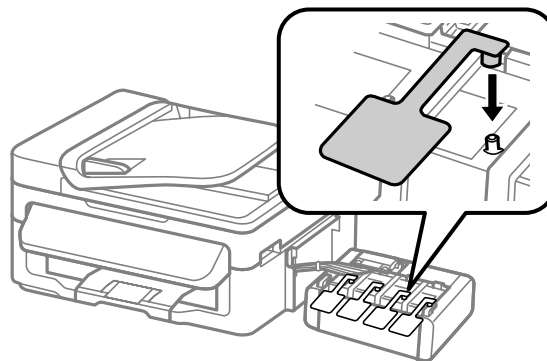

- 9** Repack the product in the box, using the protective materials that came with it.



Important:

- Keep the product level during transport. Otherwise, ink may leak.*
- After you move it, remove the tape securing the print head and the covers of ink tanks, then set the transportation lock to the unlocked (Printing) position. If you notice a decline in print quality, run a cleaning cycle or align the print head.*
- Do not put opened ink bottles in the box with product.*

Maintaining Your Product and Software

Note:

Store the covers of the installed ink tanks at the side of the product for use when transporting the product.

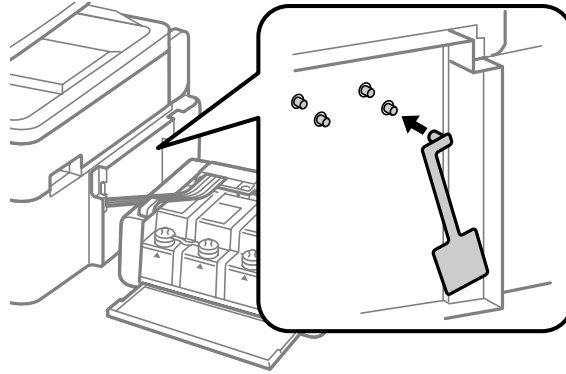

Checking and Installing Your Software

Checking the software installed on your computer

To use the functions described in this User's Guide, you need to install the following software.

- Epson Driver and Utilities
- Epson Easy Photo Print
- Epson Event Manager

Follow the steps below to check that the software is installed on your computer.

For Windows

- 1** **Windows 7 and Vista:** Click the start button and select **Control Panel**.
Windows XP: Click **Start** and select **Control Panel**.
- 2** **Windows 7 and Vista:** Click **Uninstall a program** from the Programs category.
Windows XP: Double-click the **Add or Remove Programs** icon.
- 3** Check the list of currently installed programs.

For Mac OS X

- 1** Double-click **Macintosh HD**.
- 2** Double-click the **Epson Software** folder in the Applications folder and check the contents.

Maintaining Your Product and Software

Note:

- ❑ *The Applications folder contains software provided by third parties.*
- ❑ *To check that the printer driver is installed, click **System Preferences** on the Apple menu and then click **Print & Scan** (for Mac OS X 10.7) or **Print & Fax** (for Mac OS X 10.6 or 10.5). Then locate your product in the Printers list box.*

Installing the software

Insert the product software disk that came with your product and select the software you want to install on the Software Select screen.

Uninstalling Your Software

You may need to uninstall and then reinstall your software to solve certain problems or if you upgrade your operating system.

See the following section for information on determining what applications are installed.

➔ [“Checking the software installed on your computer” on page 95](#)

For Windows

Note:

- ❑ *For Windows 7 and Vista, you need an administrator account and password if you log on as a standard user.*
- ❑ *For Windows XP, you must log on to a Computer Administrator account.*

- 1** Turn off the product.
- 2** Disconnect the product's interface cable from your computer.
- 3** Do one of the following.
 - Windows 7 and Vista:** Click the start button and select **Control Panel**.
 - Windows XP:** Click **Start** and select **Control Panel**.
- 4** Do one of the following.
 - Windows 7 and Vista:** Click **Uninstall a program** from the Programs category.
 - Windows XP:** Double-click the **Add or Remove Programs** icon.
- 5** Select the software you want to uninstall such as your product's driver and the application from the list displayed.

Maintaining Your Product and Software

6 Do one of the following.

Windows 7: Click **Uninstall/Change** or **Uninstall**.

Windows Vista: Click **Uninstall/Change** or **Uninstall**, and then click **Continue** in the User Account Control window.

Windows XP: Click **Change/Remove** or **Remove**.

Note:

*If you chose to uninstall your product's printer driver in step 5, select the icon for your product and then click **OK**.*

7 When the confirmation window appears, click **Yes** or **Next**.

8 Follow the on-screen instructions.

In some cases, a message may appear to prompt you to restart your computer. If so, make sure **I want to restart my computer now** is selected and click **Finish**.

For Mac OS X

Note:

- To uninstall your software you need to download the Uninstaller.
Access the site at:
<http://www.epson.com>
Next, select the support section of your local Epson Web site.*
- To uninstall applications, you must log on to a Computer Administrator account.
You cannot uninstall programs if you log on as a limited account user.*
- Depending on the application, the Installer may be separated from the Uninstaller.*

1 Quit all running applications.

2 Double-click the **Uninstaller** icon in your Mac OS X hard drive.

3 Select the check boxes for the software you want to uninstall, such as the printer driver and the application, from the list displayed.

4 Click **Uninstall**.

5 Follow the on-screen instructions.

If you cannot find the software you want to uninstall in the Uninstaller window, double-click the **Applications** folder in your Mac OS X hard drive, select the application you want to uninstall, and then drag it to the **Trash** icon.

Maintaining Your Product and Software



Note:

*If you uninstall the printer driver and the name of your product remains in the Print & Scan (for Mac OS X 10.7) or Print & Fax (for Mac OS X 10.6 or 10.5) window, select the name of your product and click the - **remove** button.*

Error Indicators

Error Messages on the Control Panel

This section describes the meaning of messages displayed on the LCD screen.

Error Messages	Solutions
Paper jam Press OK. If the error does not clear, remove the paper by hand.	Remove the jammed paper. ➔ "Paper Jams" on page 103
Paper jam in the ADF. Remove the jammed paper.	
Communication error. Make sure the cable is connected, then try again.	Make sure the computer is connected correctly. If the error messages still appears, make sure that scanning software is installed on your computer and that the software settings are correct.
Printer error Paper jam. Open the scanner unit and remove the paper, then turn off the printer. See your documentation.	Turn the product off and then back on. Make sure that no paper is still in the product. If the error message still appears, contact Epson support.
ADF Error. Remove any objects or documents inside ADF. Turn power off. See documentation.	
Printer error See your documentation.	
Scanner error See your documentation.	Turn the product off and then back on. If the error message still appears, contact Epson support.
A fax error has occurred. See your documentation.	
A printer's ink pad is nearing the end of its service life. Please contact Epson Support.	Press OK to resume printing. The message will be displayed until the ink pad is replaced. Contact Epson support to replace ink pads before the end of their service life. When the ink pads are saturated, the product stops and Epson support is required to continue printing.
A printer's ink pad is at the end of its service life. Please contact Epson Support.	Contact Epson support to replace the ink pad.
No dial tone. Fax job incomplete.	Make sure the phone cable is connected correctly and the phone line works. ➔ "Connecting to a Phone Line" on page 61 If you connected the product to a PBX (Private Branch Exchange) phone line or Terminal Adapter, turn off the Dial Tone Detection . ➔ Press  and then  . Then select Fax Settings > Communication > Dial Tone Detection .

Error Indicators

Error Messages	Solutions
Recovery Mode	The firmware update has failed. You will need to re-attempt the firmware update. Ready a USB cable and visit your local Epson website for further instructions.

Troubleshooting for Printing/Copying

Diagnosing the Problem

Troubleshooting product problems is best handled in two steps: first diagnose the problem, then apply likely solutions until the problem is fixed.

The information that you need to diagnose and solve most common problems is provided by online problem solving, the control panel, or the status monitor. Refer to the appropriate section below.

If you have a specific problem relating to print quality, a printing problem not related to print quality, or a paper feeding problem, or if the product does not print at all, refer to the appropriate section.

To solve a problem, you may need to cancel printing.

➔ [“Canceling printing” on page 32](#)

Checking product status

If a problem occurs while printing, an error message will appear in the status monitor window.

If an error message appears indicating the product's ink pads are nearing the end of their service life, contact Epson support to replace them. The message will be displayed at regular intervals until the ink pads are replaced. When the product's ink pads are saturated, the product stops and Epson support is required to continue printing.

For Windows

There are two ways to access EPSON Status Monitor 3:

- Double-click the product shortcut icon on your Windows taskbar. To add a shortcut icon to the taskbar, see the following section:
 - ➔ [“From the shortcut icon on the taskbar” on page 28](#)
- Open the printer driver, click the **Maintenance** tab, then click the **EPSON Status Monitor 3** button.

Troubleshooting for Printing/Copying

When you access EPSON Status Monitor 3, the following window appears:

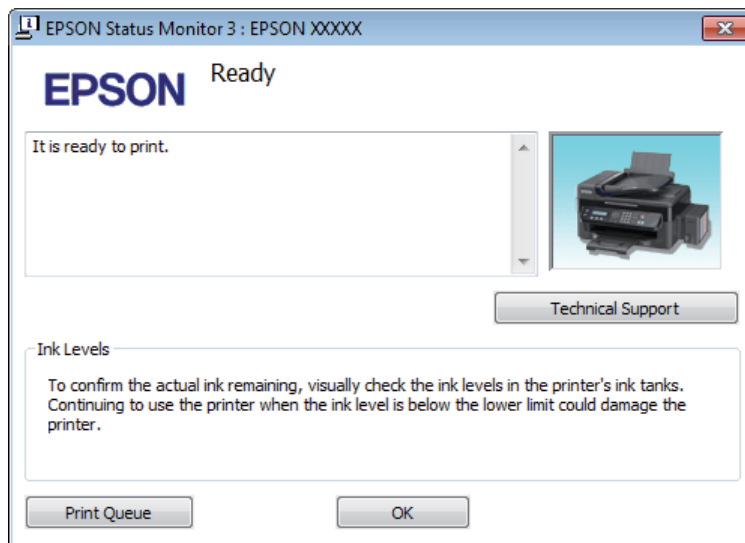

Note:

If EPSON Status Monitor 3 does not appear, access the printer driver and click the **Maintenance** tab and then the **Extended Settings** button. In the Extended Settings window, check the **Enable EPSON Status Monitor 3** check box.

EPSON Status Monitor 3 provides the following information:

- Technical Support:**
Click **Technical Support** to access the Epson technical support website.
- Print Queue:**
You can view Windows Spooler by clicking **Print Queue**.

For Mac OS X

Follow these steps to access EPSON Status Monitor.

- 1** Access the Epson Printer Utility 4.
➔ [“Accessing the printer driver for Mac OS X” on page 28](#)

Troubleshooting for Printing/Copying

2

Click the **EPSON Status Monitor** icon. The EPSON Status Monitor appears.

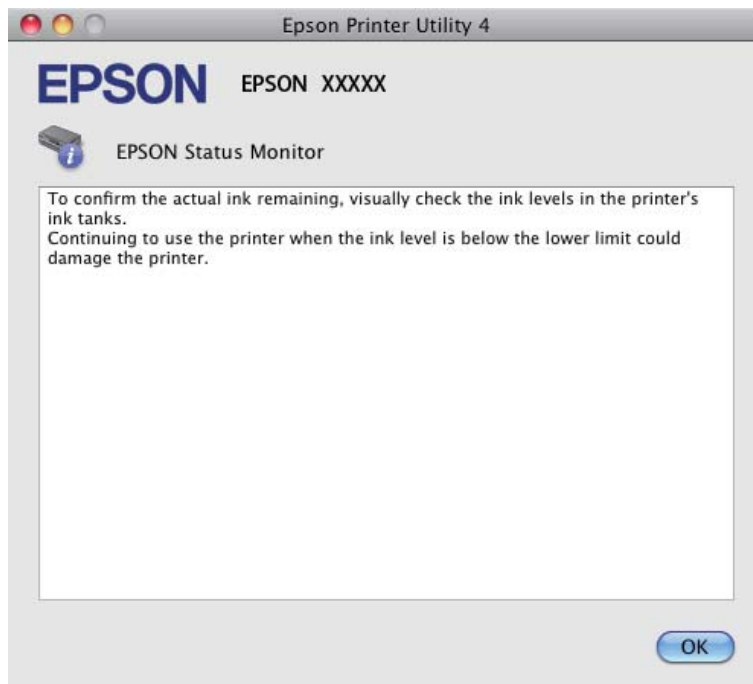

Paper Jams

**Caution:**

Never touch the buttons on the control panel while your hand is inside the product.

**Important:**

Be careful not to pull the cables or ink tubes, or touch other components inside the product unnecessarily. Otherwise, ink may leak or the product may be damaged.

Note:

- Cancel the print job if prompted by a message from the LCD screen or the printer driver.*
- After you have removed the jammed paper, press the button indicated in the LCD screen.*

Removing jammed paper from inside the product

- 1 Open the scanner unit.

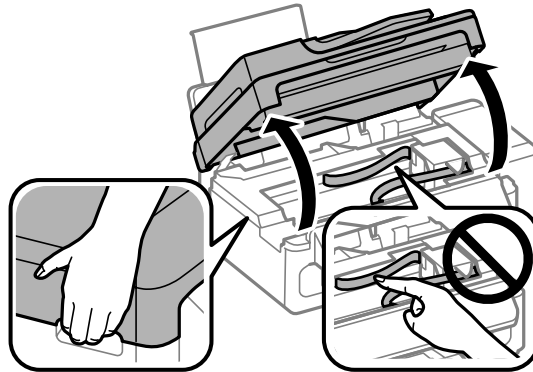

! **Important:**
Do not lift up the scanner unit when the document cover is open.



- 2 Remove all of the paper inside, including any torn pieces.

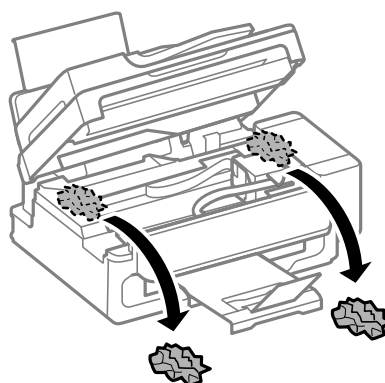

- 3 Close the scanner unit slowly.

Removing jammed paper from the Automatic Document Feeder (ADF)

- 1 Remove the stack of paper from the ADF input tray.

Troubleshooting for Printing/Copying

- 2 Open the ADF cover.

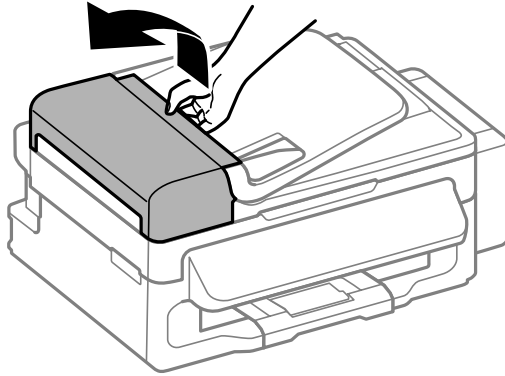

! **Important:**

Make sure you open the ADF cover before removing jammed paper. If you do not open the cover, the product may be damaged.

- 3 Carefully remove the jammed paper.

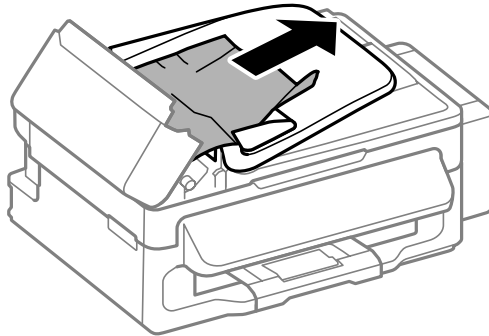

- 4 Open the Automatic Document Feeder (ADF).

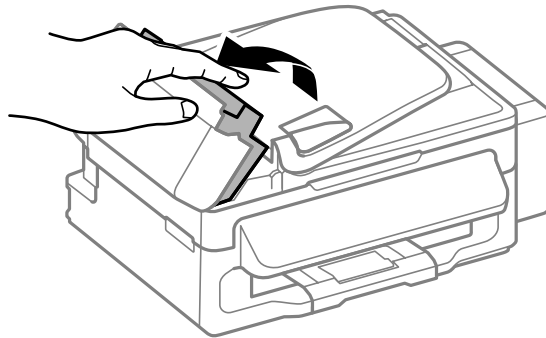

Troubleshooting for Printing/Copying

- 5 Remove all of the paper inside, including any torn pieces.

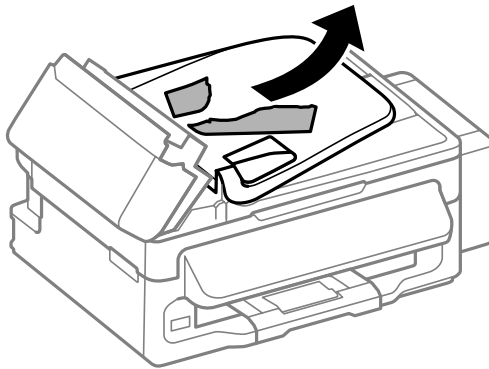

- 6 Close the Automatic Document Feeder (ADF).

- 7 Raise the ADF input tray.

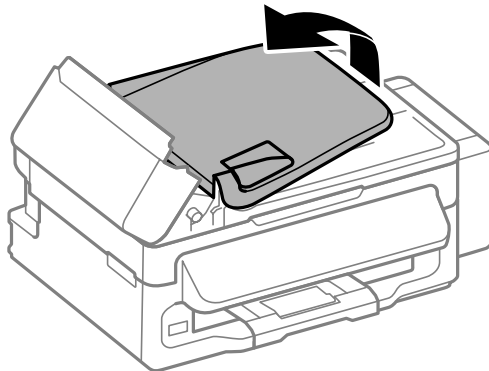

- 8 Carefully remove the jammed paper.

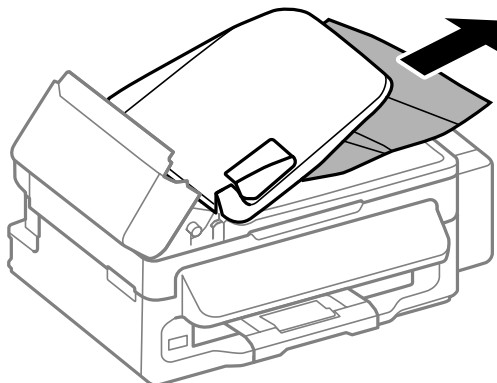

- 9 Return the ADF input tray to its original position, and close the ADF cover.

Preventing paper jams

If your paper jams frequently, check the following.

- The paper is smooth, not curled or wrinkled.

Troubleshooting for Printing/Copying

- You are using high-quality paper.
- The printable side of the paper is face up in the rear paper feed.
- The paper stack was fanned before loading.
- For plain paper, do not load paper above the line just under the ▼ arrow mark inside the edge guide. For Epson special media, make sure the number of sheets is less than the limit specified for the media.
➔ [“Selecting Paper” on page 17](#)
- The edge guides are snug against the edges of the paper.
- The product is on a flat, stable surface that extends beyond the base in all directions. The product will not operate properly if it is tilted.

Reprinting after a paper jam (for Windows only)





After you cancel the print job because of a paper jam, you can reprint it without reprinting pages that have already been printed.

- 1** Solve the paper jam.
➔ [“Paper Jams” on page 103](#)
- 2** Access the printer settings.
➔ [“Accessing the printer driver for Windows” on page 27](#)
- 3** Select the **Print Preview** check box in the Main window of your printer driver.
- 4** Make the settings that you want to use to print.
- 5** Click **OK** to close the printer settings window, and then print your file. Print Preview window opens.
- 6** Select a page that has already been printed in the page list box on the left side, and then select **Remove Page** from the Print Options menu. Repeat this step for all the pages that have already been printed.
- 7** Click **Print** on the Print Preview window.

Print Quality Help

If you are having print quality problems, then compare it with the illustrations below. Click the caption under the illustration that best resembles your prints.

Troubleshooting for Printing/Copying

<p>enthalten alle Aufdruck. W 5008 "Regel</p> <p>Good sample</p>	 <p>Good sample</p>
<p>enthalten alle Aufdruck. W 5008 "Regel</p> <p>➔ "Horizontal banding" on page 108</p>	<p>enthalten alle Aufdruck. W 5008 "Regel</p> <p>➔ "Vertical banding or misalignment" on page 109</p>
 <p>➔ "Horizontal banding" on page 108</p>	 <p>➔ "Vertical banding or misalignment" on page 109</p>
 <p>➔ "Incorrect or missing colors" on page 109</p>	 <p>➔ "Blurry or smeared print" on page 110</p>

Horizontal banding

- Make sure the printable side (the whiter or glossier side) of the paper is face up in the rear paper feed.
- Run the Head Cleaning utility to clear any clogged ink nozzles.
 - ➔ "Cleaning the Print Head" on page 84
- Try to use genuine Epson ink bottles.
- Make sure the paper type selected in the LCD menu or printer driver is appropriate for the type of paper loaded in the product.
 - ➔ "Selecting Paper" on page 17
- If banding appears at intervals of 2.5 cm, run the Print Head Alignment utility.
 - ➔ "Aligning the Print Head" on page 85

Troubleshooting for Printing/Copying

- ❑ If a moire (cross-hatch) pattern appears on your copy, change the **Reduce/Enlarge** setting in the LCD menu or shift the position of your original.
- ❑ If there is problem with copy quality, clean the exterior of the product.
➔ [“Cleaning the exterior of the product” on page 91](#)

Vertical banding or misalignment

- ❑ Make sure the printable side (the whiter or glossier side) of the paper is face up in the rear paper feed.
- ❑ Run the Head Cleaning utility to clear any clogged ink nozzles.
➔ [“Cleaning the Print Head” on page 84](#)
- ❑ Run the Print Head Alignment utility.
➔ [“Aligning the Print Head” on page 85](#)
- ❑ For Windows, clear the **High Speed** check box from the More Options window in your printer driver. See the online help for details.
For Mac OS X, select **Off** from the High Speed Printing. To display the High Speed Printing, click through the following menus: **System Preferences, Print & Scan** (for Mac OS X 10.7) or **Print & Fax** (for Mac OS X 10.6 or 10.5), your product (in the Printers list box), **Options & Supplies**, and then **Driver**.
- ❑ Make sure the paper type selected in the LCD menu or printer driver is appropriate for the type of paper loaded in the product.
➔ [“Selecting Paper” on page 17](#)
- ❑ If there is problem with copy quality, clean the exterior of the product.
➔ [“Cleaning the exterior of the product” on page 91](#)

Incorrect or missing colors

- ❑ Make sure the initial ink charging is complete.
- ❑ Make sure the transportation lock is in the unlocked (Printing) position.
- ❑ Check the ink tank. If the ink level is below the lower limit on the ink tank, refill the ink soon.
- ❑ For Windows, clear the **Grayscale** setting in the Main window in your printer driver.
For Mac OS X, clear the **Grayscale** setting in Print Settings in the Print dialog box in your printer driver.
See the online help for details.
- ❑ Adjust the color settings in your application or in your printer driver settings.
For Windows, check the More Options window.
For Mac OS X, check the Color Options dialog box from the Print dialog box.
See the online help for details.
- ❑ Run the Head Cleaning utility to clear any clogged ink nozzles.
➔ [“Cleaning the Print Head” on page 84](#)
- ❑ If you have not used the product for a long time, use the Power Ink Flushing utility of the printer driver.
➔ [“Replacing Ink inside the Ink Tubes” on page 88](#)

Troubleshooting for Printing/Copying

- ❑ Try to use genuine Epson ink bottles and paper recommended by Epson.

Blurry or smeared print

- ❑ Try to use genuine Epson ink bottles and paper recommended by Epson.
- ❑ Make sure the product is on a flat, stable surface that extends beyond the base in all directions. The product will not operate properly if it is tilted.
- ❑ Make sure the transportation lock is in the unlocked (Printing) position.
- ❑ Check the ink tank. If the ink level is below the lower limit on the ink tank, refill the ink soon.
- ❑ Make sure your paper is not damaged, dirty, or too old.
- ❑ Make sure your paper is dry and the printable side (the whiter or glossier side) is face up in the rear paper feed.
- ❑ If the paper is curled toward the printable side, flatten it or curl it slightly in the opposite direction.
- ❑ Make sure the paper type selected in the LCD menu or printer driver is appropriate for the type of paper loaded in the product.
 - ➔ [“Selecting Paper” on page 17](#)
- ❑ Remove each sheet from the output tray as it is printed.
- ❑ Do not touch or allow anything to come into contact with the printed side of paper with a shiny finish. To handle your prints, follow the instructions of the paper.
- ❑ Run the Head Cleaning utility to clear any clogged ink nozzles.
 - ➔ [“Cleaning the Print Head” on page 84](#)
- ❑ Run the Print Head Alignment utility.
 - ➔ [“Aligning the Print Head” on page 85](#)
- ❑ If the paper is smeared with ink after printing, clean the interior of the product.
 - ➔ [“Cleaning the interior of the product” on page 92](#)
- ❑ If there is problem with copy quality, clean the exterior of the product.
 - ➔ [“Cleaning the exterior of the product” on page 91](#)
- ❑ If you have not used the product for a long time, use the Power Ink Flushing utility of the printer driver.
 - ➔ [“Replacing Ink inside the Ink Tubes” on page 88](#)

Miscellaneous Printout Problems

Incorrect or garbled characters

- ❑ Clear any stalled print jobs.
 - ➔ [“Canceling printing” on page 32](#)
- ❑ Turn off the product and computer. Make sure the product's interface cable is securely plugged in.

Troubleshooting for Printing/Copying

- ❑ Uninstall the printer driver, then reinstall it.
➔ [“Uninstalling Your Software” on page 96](#)

Incorrect margins

- ❑ Make sure that the paper is loaded into the rear paper feed correctly.
➔ [“Loading Paper and Envelopes” on page 19](#)
- ❑ Check the margin settings in your application. Make sure that the margins are within the printable area of the page.
➔ [“Printable area” on page 127](#)
- ❑ Make sure the printer driver settings are appropriate for the paper size you are using.
For Windows, check the Main window.
For Mac OS X, check the Page Setup dialog box or Print dialog box.
- ❑ Uninstall the printer driver, then reinstall it.
➔ [“Uninstalling Your Software” on page 96](#)

Printout has a slight slant

- ❑ Make sure that the paper is loaded into the rear paper feed correctly.
➔ [“Loading Paper and Envelopes” on page 19](#)
- ❑ If **Draft** is selected in Quality in the Main window in your printer driver (for Windows), or **Fast Economy** is selected in Print Quality in Print Settings (for Mac OS X), select another setting.

Size or position of copied image is incorrect

- ❑ Make sure the paper size, layout, or reduce/enlarge setting selected in the control panel matches the paper used.
- ❑ If the edges of the copy are cropped off, move the original slightly away from the corner.
- ❑ Clean the scanner glass.
➔ [“Cleaning the exterior of the product” on page 91](#)

Inverted image

- ❑ For Windows, clear the **Mirror Image** check box from the More Options window of your printer driver, or turn off the Mirror Image setting in your application.
For Mac OS X, clear the **Mirror Image** check box in **Print Settings** in the Print dialog box of your printer driver, or turn off the Mirror Image setting in your application.
For instructions, see the online help for your printer driver or for your application.
- ❑ Uninstall the printer driver, then reinstall it.
➔ [“Uninstalling Your Software” on page 96](#)

Troubleshooting for Printing/Copying

Blank pages print

- ❑ Make sure the printer driver settings are appropriate for the paper size you are using.
For Windows, check the Main window.
For Mac OS X, check the Page Setup dialog box or Print dialog box.
- ❑ For Windows, check the **Skip Blank Page** setting by clicking the **Extended Settings** button on the Maintenance window of the printer driver.
For Mac OS X, select **On** from the Skip Blank Page. To display the Skip Blank Page, click through the following menus: **System Preferences, Print & Scan** (for Mac OS X 10.7) or **Print & Fax** (for Mac OS X 10.6 or 10.5), your product (in the Printers list box), **Options & Supplies**, and then **Driver**.
- ❑ Uninstall the printer driver, then reinstall it.
➔ [“Uninstalling Your Software” on page 96](#)

Printed side is smeared or scuffed

- ❑ If the paper is curled toward the printable side, flatten it or curl it slightly in the opposite direction.
- ❑ Make several copies without placing a document on the scanner glass.
➔ [“Cleaning the interior of the product” on page 92](#)
- ❑ Uninstall the printer driver, then reinstall it.
➔ [“Uninstalling Your Software” on page 96](#)

Printing is too slow

- ❑ Make sure the paper type selected in the LCD menu or printer driver is appropriate for the type of paper loaded in the product.
➔ [“Selecting Paper” on page 17](#)
- ❑ For Windows, choose a lower **Quality** in the printer driver Main window.
For Mac OS X, choose a lower Print Quality in the Print Settings dialog box from your printer driver's Print dialog box.
➔ [“Accessing the printer driver for Windows” on page 27](#)
➔ [“Accessing the printer driver for Mac OS X” on page 28](#)
- ❑ Close any unnecessary applications.
- ❑ If you print continuously for an extended period, the printing may be extremely slow. This is to slow down the printing speed and prevent the product mechanism from overheating and being damaged. If this happens, you can continue to print, but we recommend stopping and leaving the product idle for at least 30 minutes with the power on. (The product does not recover with the power off.) After you restart, the product will print at normal speed.
- ❑ Uninstall the printer driver, then reinstall it.
➔ [“Uninstalling Your Software” on page 96](#)

If you try all of the methods above and cannot solve the problem, see the following:

- ➔ [“Increasing the Print Speed \(For Windows Only\)” on page 115](#)

Paper Does Not Feed Correctly

Paper does not feed

Remove the stack of paper and make sure of the following:

- The paper is not curled or creased.
- The paper is not too old. See the instructions that came with the paper for more information.
- For plain paper, do not load paper above the line just under the ▼ arrow mark inside the edge guide. For Epson special media, make sure the number of sheets is less than the limit specified for the media.
➔ [“Selecting Paper” on page 17](#)
- Paper is not jammed inside the product. If it is, remove the jammed paper.
➔ [“Paper Jams” on page 103](#)
- You have followed any special loading instructions that came with your paper.

Multiple pages feed

- For plain paper, do not load paper above the line just under the ▼ arrow mark inside the edge guide. For Epson special media, make sure the number of sheets is less than the limit specified for the media.
➔ [“Selecting Paper” on page 17](#)
- Make sure the edge guides are snug against the edges of the paper.
- Make sure the paper is not curled or folded. If so, flatten it or curl it slightly toward the opposite side before loading.
- Remove the stack of paper and make sure that the paper is not too thin.
➔ [“Paper” on page 126](#)
- Fan the edges of the stack to separate the sheets, then reload the paper.
- If too many copies of a file are being printed, check the Copies setting in your printer driver as follows, and also check in your application.
For Windows, check the Copies setting on the Main window.
Mac OS X, check the Copies setting in the Print dialog.

Paper is improperly loaded

If you have loaded the paper too far into the product, the product cannot feed the paper correctly. Turn the product off and gently remove the paper. Then turn the product on and reload the paper correctly.

Paper is not ejected fully or is wrinkled

- ❑ If the paper does not eject fully, press one of the  buttons to eject the paper. If the paper is jammed inside the product, remove it by referring to the following section.
 - ➔ [“Paper Jams” on page 103](#)
- ❑ If the paper is wrinkled when it comes out, it may be damp or too thin. Load a new stack of paper.

Note:

Store any unused paper in its original packaging in a dry area.

The Product Does Not Print

All lights are off

- ❑ Press the  button to make sure the product is on.
- ❑ Make sure that the power cord is securely plugged in.
- ❑ Make sure that your outlet works and is not controlled by a wall switch or timer.

Only the power light is on

- ❑ Turn off the product and computer. Make sure the product's interface cable is securely plugged in.
- ❑ If you are using the USB interface, make sure your cable meets the USB or Hi-Speed USB standards.
- ❑ If you are connecting the product to your computer via a USB hub, connect the product to the first-tier hub from your computer. If the printer driver is still not recognized on your computer, try to directly connect the product to your computer without the USB hub.
- ❑ If you are connecting the product to your computer via a USB hub, make sure the USB hub device is recognized by your computer.
- ❑ If you are trying to print a large image, your computer may not have enough memory. Try reducing the resolution of your image or printing the image at a smaller size. You may need to install more memory in your computer.
- ❑ Users of Windows can clear any stalled print jobs from the Windows Spooler.
 - ➔ [“Canceling printing” on page 32](#)
- ❑ Uninstall the printer driver, then reinstall it.
 - ➔ [“Uninstalling Your Software” on page 96](#)

Troubleshooting for Printing/Copying

Increasing the Print Speed (For Windows Only)

Print speed may be increased by selecting certain settings in the Extended Settings window when the printing speed is slow. Click the **Extended Settings** button on your printer driver's Maintenance window.

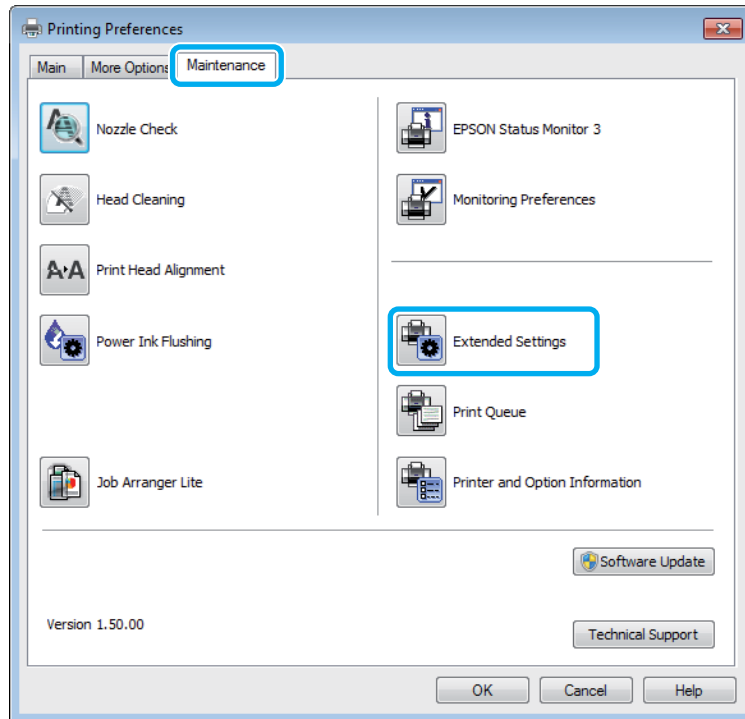

The following dialog box appears.

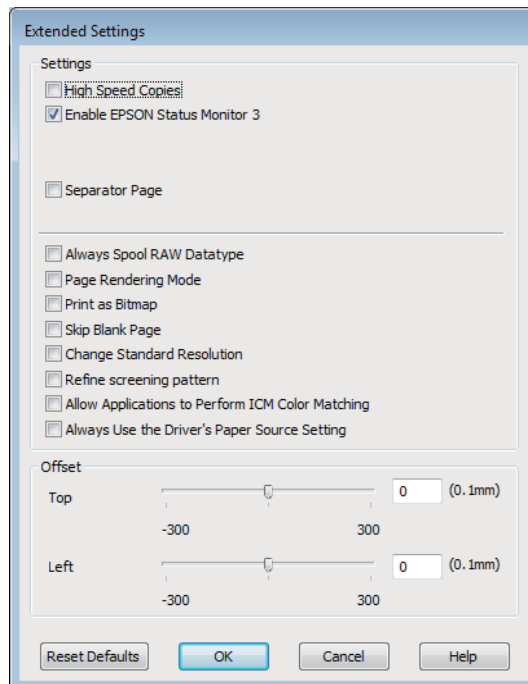

Select the following check boxes and print speed may be increased.

- High Speed Copies

Troubleshooting for Printing/Copying

- Always spool RAW datatype
- Page Rendering Mode
- Print as Bitmap

For more details on each item, see the online help.

Other Problem

Printing plain papers quietly

When plain paper is selected for the paper type and Standard (Windows) or Normal (Mac OS X) is selected as for quality in the printer driver, the product prints at high speed. Try choosing Quiet Mode for quieter operation which will reduce the print speed.

For Windows, select the Quiet Mode check box in the Main window of your printer driver.

For Mac OS X, select **On** from the Quiet Mode. To display the Quiet Mode, click through the following menus: **System Preferences, Print & Scan** (for Mac OS X 10.7) or **Print & Fax** (for Mac OS X 10.6 or 10.5), your product (in the Printers list box), **Options & Supplies**, and then **Driver**.

Troubleshooting for Scanning

Problems Indicated by Messages on the LCD Screen or Status Light

- Make sure the product is connected to your computer properly.
- Turn off the product and turn it on again. If the problem is not solved, the product may be malfunctioning, or the light source in the scanner unit may need to be replaced. Contact your dealer.
- Make sure the scanning software is fully installed.
See the paper manual for instructions on installing the scanning software.

Problems When Starting a Scan

- Check the status light and make sure the product is ready to scan.
- Make sure your cables are securely connected to the product and a working electrical outlet.
If necessary, test your product's AC adapter by plugging in another electrical device and turning it on.
- Turn off the product and computer, and then check the interface cable connection between them to make sure it is secure.
- Make sure you select the correct product if a scanner list appears when starting to scan.

Windows:

When you start Epson Scan using the EPSON Scan icon, and the Select Scanner list is displayed, make sure you select the model of your product.

Mac OS X:

When you start Epson Scan from the Applications folder and the Select Scanner list is displayed, make sure you select the model of your product.

- Connect the product directly to the computer's external USB port or through one USB hub only. The product may not work properly when connected to the computer through more than one USB hub. If the problem persists, try connecting the product directly to the computer.
- If more than one product is connected to your computer, it may not work. Connect only the product you want to use, and then try scanning again.
- If the scanning software does not work properly, uninstall the software first and then reinstall it as described in the paper manual.
➔ ["Uninstalling Your Software" on page 96](#)

Using the Automatic Document Feeder (ADF)

- Check the ADF light and make sure the ADF is ready to scan.

Troubleshooting for Scanning

- Make sure there are no originals on the scanner glass.
- If the document cover or ADF cover is open, close it and try scanning again.
- Make sure you have selected either **Office Mode** or **Professional Mode** in Epson Scan.
- Make sure your cables are securely connected to the product and a working electrical outlet.
- If the ADF light is on and your originals are not fed, check that there is no foreign object inside the hole on the left front corner of the scanner glass.

Using the button

Note:

Depending on the product, the scanning function may not be available when using the button.

- Check if you have assigned a program to the button.
 - ➔ [“Epson Event Manager” on page 60](#)
- Make sure Epson Scan and Epson Event Manager are installed correctly.
- If you have clicked the **Keep Blocking** button in the Windows Security Alert window during or after installation of the Epson Software, unblock Epson Event Manager.
 - ➔ [“How to unblock Epson Event Manager” on page 118](#)
- Mac OS X:
Make sure you are logged on as the user who installed the scanning software. Other users must first start Epson Scanner Monitor in the Applications folder and then press a button to scan.

How to unblock Epson Event Manager

1 Click **Start** or the start button, and then point to **Control Panel**.

2 Do one of the following.

- Windows 7:
Select **System and Security**.
- Windows Vista:
Select **Security**.
- Windows XP:
Select **Security Center**.

3 Do one of the following.

- Windows 7 and Windows Vista:
Select **Allow a program through Windows Firewall**.
- Windows XP:
Select **Windows Firewall**.

Troubleshooting for Scanning

4

Do one of the following.

- Windows 7:
Confirm that the check box for **EEventManager Application** is selected in the Allowed programs and features list.
- Windows Vista:
Click the **Exceptions** tab, and then confirm that the check box for **EEventManager Application** is selected in the Program or port list.
- Windows XP:
Click the **Exceptions** tab, and then confirm that the check box for **EEventManager Application** is selected in the Programs and Services list.

5

Click OK.

Using scanning software other than Epson Scan driver

- If you are using any TWAIN-compliant programs, such as Adobe Photoshop Elements, make sure that the correct product is selected as the Scanner or Source setting.
- If you cannot scan using any TWAIN-compliant scanning programs, such as Adobe Photoshop Elements, uninstall the TWAIN-compliant scanning program and then reinstall it.
 - ➔ [“Uninstalling Your Software” on page 96](#)

Problems When Feeding Paper

The paper gets dirty

You may need to clean the product.

➔ [“Cleaning the Product” on page 91](#)

Multiple sheets of paper are fed

- If you load unsupported paper, the product may feed more than one sheet of paper at a time.
 - ➔ [“Automatic Document Feeder \(ADF\) specifications” on page 128](#)
- You may need to clean the product.
 - ➔ [“Cleaning the Product” on page 91](#)

The paper jams in the Automatic Document Feeder (ADF)

Remove the jammed paper inside the ADF.

➔ [“Removing jammed paper from the Automatic Document Feeder \(ADF\)” on page 104](#)

Problems With Scanning Time

- Computers with Hi-Speed external USB ports can scan faster than those with external USB ports. If you are using a Hi-Speed external USB port with your product, make sure it meets the system requirements.
➔ [“System Requirements” on page 125](#)
- Scanning at a high resolution takes a long time.

Problems With Scanned Images

Scan quality is unsatisfactory

Scan quality can be improved by changing the current settings or adjusting the scanned image.

- ➔ [“Image Adjustment Features” on page 43](#)

An image on the back of your original appears in your scanned image

If your original is printed on thin paper, images on the back may be visible to the product and appear in your scanned image. Try scanning the original with a piece of black paper placed on the back of it. Also make sure the Document Type and Image Type settings are correct for your original.

Characters are distorted or blurred

- In Office Mode or Home Mode, select the **Text Enhancement** check box.
- Adjust the Threshold setting.

Home Mode:

Select **Black&White** as the Image Type setting, click the **Brightness** button, and then try adjusting the Threshold setting.

Office Mode:

Select **Black&White** as the Image Type setting, and then try adjusting the Threshold setting.

Professional Mode:

Select **Black & White** as the Image Type setting and click the + (Windows) or ► (Mac OS X) button next to **Image Type**. Make the appropriate Image Option setting and then try adjusting the Threshold setting.

- Increase the resolution setting.

Characters are not recognized correctly when converted into editable text (OCR)

Place the document so that it is straight on the scanner glass. If the document is skewed, it may not be recognized correctly.

Troubleshooting for Scanning

Ripple patterns appear in your scanned image

A ripple or cross-hatch pattern (known as moiré) may appear in a scanned image of a printed document.



- Rotate your original document.
- Rotate the scanned image using the application software after scanning.
- Select the **Descreening** check box.
- In Professional Mode, change a resolution setting and scan again.

Uneven color, smears, dots, or straight lines appear in your image

You may need to clean the interior of the product.

➔ [“Cleaning the Product” on page 91](#)

The scanning area or direction is unsatisfactory

The edges of your original are not scanned

- If you are scanning using thumbnail preview in Home Mode or Professional Mode, move the document or photo 6 mm (0.2 inch) away from the horizontal and vertical edges of the scanner glass to avoid cropping.
- If you are scanning using the button or using normal preview in Office Mode, Home Mode, or Professional Mode, move the document or photo about 3 mm (0.12 inch) away from the horizontal and vertical edges of the scanner glass to avoid cropping.

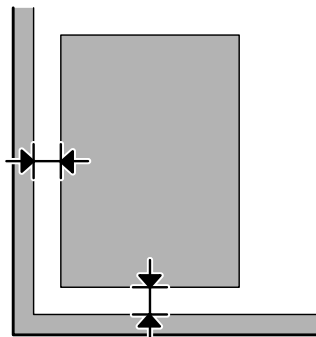

Troubleshooting for Scanning

Multiple documents are scanned into a single file

Position documents at least 20 mm (0.8 inch) apart from each other on the scanner glass.

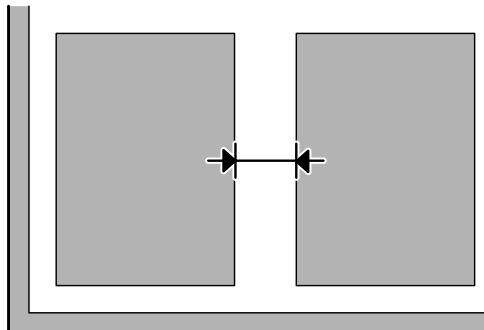

Cannot scan the area you want

Depending on the documents, you may not be able to scan the area you want. Use normal preview in Office Mode, Home Mode, or Professional Mode and create marquees on the area you want to scan.

Cannot scan in the direction you want

Click **Configuration**, select the **Preview** tab, and then clear the **Auto Photo Orientation** check box. Then, place your documents correctly.

Problems Remain After Trying All Solutions

If you have tried all the solutions and have not solved the problem, initialize the Epson Scan settings.

Click **Configuration**, select the **Other** tab, and then click **Reset All**.

Troubleshooting for Faxing

Cannot send and receive fax

- ❑ Make sure the phone cable is connected correctly and check that the phone line works. You can check the line status by using the **Check Fax Connection** function.
 - ➔ [“Connecting to a Phone Line” on page 61](#)
- ❑ If the fax did not send, make sure that the recipient's fax machine is turned on and working.
- ❑ If this product is not connected to a phone and you want to receive faxes automatically, make sure you turn on auto answer.
 - ➔ [“Receiving Faxes” on page 70](#)
- ❑ If you are using the Automatic Document Feeder, check that the ADF light is on. Make sure there are no originals on the scanner glass.
- ❑ If the ADF light is on and your originals are not fed, check that there is no foreign object inside the hole on the left front corner of the scanner glass.
- ❑ If you connected the product to a DSL phone line, you must install a DSL filter on the line otherwise you cannot fax. Contact your DSL provider for the necessary filter.
- ❑ If you connected this product to a PBX (Private Branch Exchange) phone line or Terminal Adapter, turn off **Dial Tone Detection**.
 - ➔ [“Fax Mode” on page 74](#)
- ❑ Transmission speed may be the cause of the problem. Choose a slower **Fax Speed** setting.
 - ➔ [“Fax Mode” on page 74](#)
- ❑ Make sure that **ECM** is turned on. Color faxes cannot be sent and received when **ECM** is off.
 - ➔ [“Fax Mode” on page 74](#)

Quality problems (sending)

- ❑ Clean the scanner glass and Automatic Document Feeder (ADF).
 - ➔ [“Cleaning the exterior of the product” on page 91](#)
- ❑ If the fax you sent was faint or not clear, change the **Resolution** (or **Quality** depending on your model) or **Contrast** in the fax settings menu.
 - ➔ [“Fax Mode” on page 74](#)
- ❑ Make sure that **ECM** is turned on.
 - ➔ [“Fax Mode” on page 74](#)

Quality problems (receiving)

- ❑ Make sure that ECM is turned on.
 - ➔ [“Fax Mode” on page 74](#)

Answering machine cannot answer voice calls

- ❑ When auto answer is turned on and an answering machine is connected to the same phone line as this product, set the number of rings to answer for receiving faxes to a higher number than the number of rings for the answering machine.
 - ➔ [“Receiving Faxes” on page 70](#)

Incorrect time

- ❑ The clock may run fast/slow or may be reset after a power failure, or the power is left off for a long time. Set the correct time.
 - ➔ [“Setting/Changing Time and Region” on page 87](#)

Product Information

Ink Bottles

You can use the following ink bottles with this product:

Ink bottles	Part numbers
Black	T6641
Cyan	T6642
Magenta	T6643
Yellow	T6644



Important:

Genuine Epson ink, other than those specified here, could cause damage that is not covered by Epson's warranties.

Color	Black, Cyan, Magenta, Yellow
Ink bottle life	For best results, use up ink within six months after removing a seal from ink bottle.
Temperature	Storage: -20 to 40 °C (-4 to 104 °F) 1 month at 40 °C (104 °F) Freezing:.* -16 °C (3.2 °F)

* Ink thaws and is usable after approximately 3 hours at 25 °C (77 °F).

System Requirements

For Windows

System	PC Interface
Windows 7 (32-bit, 64-bit), Vista (32-bit, 64-bit), XP SP1 or higher(32-bit), or XP Professional x64 Edition	Hi-Speed USB

For Mac OS X

System	PC Interface
Mac OS X 10.5.8 or later	Hi-Speed USB

Note:

The UNIX File System (UFS) for Mac OS X is not supported.

Technical Specifications

Note:

Specifications are subject to change without notice.

Printer specifications

Paper path	Rear paper feed, top entry
Capacity	11 mm (0.4in.)

Paper

Note:

- Since the quality of any particular brand or type of paper may be changed by the manufacturer at any time, Epson cannot attest to the quality of any non-Epson brand or type of paper. Always test samples of paper stock before purchasing large quantities or printing large jobs.
- Poor quality paper may reduce print quality and cause paper jams or other problems. If you encounter problems, switch to a higher grade of paper.

Single sheets:

Size	A4 210 × 297 mm 10 × 15 cm (4 × 6 in.) 13 × 18 cm (5 × 7 in.) A6 105 × 148 mm A5 148 × 210 mm B5 182 × 257 mm 9 × 13 cm (3.5 × 5 in.) 13 × 20 cm (5 × 8 in.) 20 × 25 cm (8 × 10 in.) 16:9 wide size (102 × 181 mm) 100 × 148 mm Letter 8 1/2 × 11 in. Legal 8 1/2 × 14 in.
Paper types	Plain paper or special paper distributed by Epson
Thickness (for plain paper)	0.08 to 0.11 mm (0.003 to 0.004 in.)

Product Information

Weight (for plain paper)	64 g/m ² (17 lb) to 90 g/m ² (24 lb)
---------------------------------	--

Envelopes:

Size	Envelope #10 4 1/8 × 9 1/2 in. Envelope DL 110 × 220 mm Envelope C6 114 × 162 mm
Paper types	Plain paper
Weight	75 g/m ² (20 lb) to 90 g/m ² (24 lb)

Printable area

Highlighted portions show printable area.

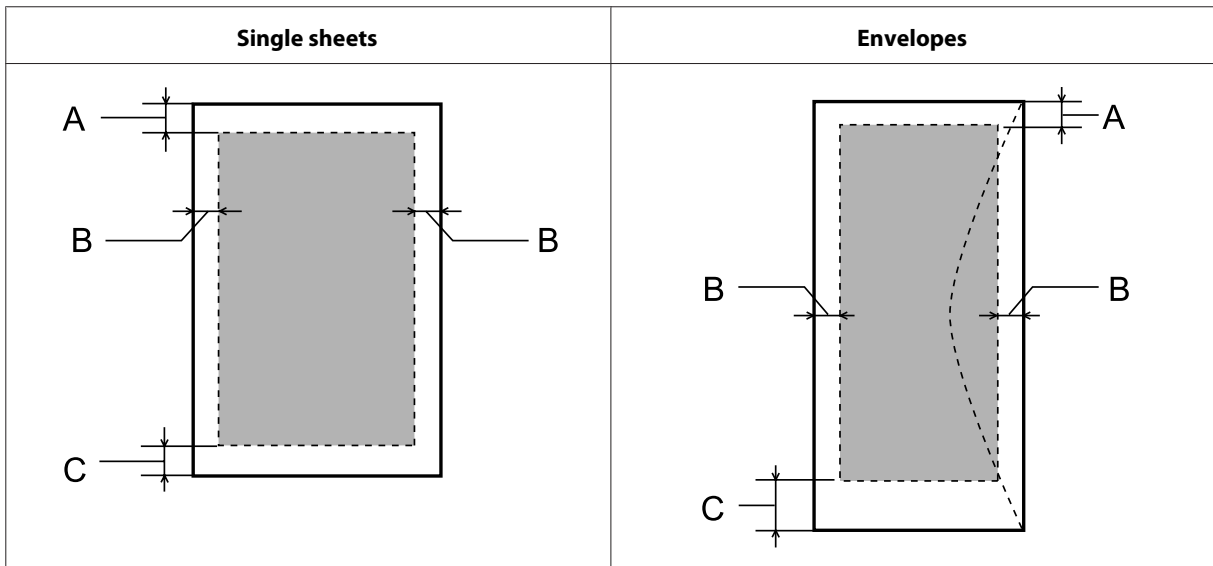

Media type	Minimum margin	
	Single sheets	Envelopes
A	3.0 mm (0.12 in.)	3.0 mm (0.12 in.)
B	3.0 mm (0.12 in.)	5.0 mm (0.20 in.)
C	3.0 mm (0.12 in.)	21.0 mm (0.83 in.)

Note:
Depending on the type of paper, print quality may decline in the top and bottom areas of the print, or the area may be smeared.

Product Information

Scanner specifications

Scanner type	Flatbed color
Photoelectric device	CIS
Effective pixels	10200 × 14040 pixels at 1200 dpi Scanning area may be restricted if resolution setting is large.
Document size	216 × 297 mm (8.5 × 11.7 inches) A4 or US letter size
Scanning resolution	1200 dpi (main scan) 2400 dpi (sub scan)
Output resolution	50 to 4800, 7200, and 9600 dpi (50 to 4800 dpi in 1 dpi increments)
Image data	16 bits per pixel per color internal 8 bits per pixel per color external (maximum)
Light source	LED

Automatic Document Feeder (ADF) specifications

Paper input	Face-up loading
Paper output	Face-down ejection
Paper size	A4, Letter, Legal
Paper types	Plain paper
Paper weight	64 to 95 g/m ²
Paper capacity	Total thickness of 3 mm, up to about 30 sheets (Letter, A4) 10 sheets (Legal)

Fax specifications

Fax type	Walk-up black and white and color fax capability
Support line	Household phone line
Speed	Up to 33.6 kbps
Resolution	Monochrome Standard: 203 × 98 dpi Fine: 203 × 196 dpi Photo: 203 × 196 dpi Color Fine: 200 × 200 dpi Photo: 200 × 200 dpi

Product Information

Error correction mode	CCITU/ITU Group 3 fax with error correction mode
Speed dial numbers	Up to 60
Page memory	Up to 180 pages (ITU-T No.1 chart)
Redial	2 times (with 1 minute interval)
Interface	RJ-11 Phone Line RJ-11 Telephone set connection

Network interface specification

Wi-Fi*1	Standard:	IEEE 802.11b/g/n*2
	Security:	WEP (64/128bit) WPA-PSK (TKIP/AES) *3
	Frequency Band:	2.4 GHz
	Communication Mode:	Infrastructure, Ad hoc
Ethernet*1	Standard:	IEEE802.3i/u, IEEE802.3az*4
	Communication Mode:	Ethernet 100BASE-TX/10BASE-T

*1 The availability of this feature varies by product.

*2 Complies with either IEEE 802.11b/g/n or IEEE 802.11b/g depending on location of purchase.

*3 Complies with WPA2 with support for WPA/WPA2 Personal.

*4 The connected device should comply with IEEE802.3az.

Mechanical

	L550	L555
Dimensions	Storage Width: 474 mm (18.7 inches) Depth: 377 mm (14.8 inches) Height: 226 mm (8.9 inches)	
	Printing *1 Width: 474 mm (18.7 inches) Depth: 540 mm (21.3 inches) Height: 291 mm (11.5 inches)	
Weight	Approx. 6.2 kg (13.7 lb) *2	Approx. 6.2 kg (13.7 lb) *2

*1 With the output tray extension extended.

*2 Without the ink and the power cord.

Product Information

Electrical

L550

		100-240 V Model
Input voltage range		90 to 264 V
Rated frequency range		50 to 60 Hz
Input frequency range		49.5 to 60.5 Hz
Rated current		0.5 to 0.3 A
Power consumption	Standalone copying	Approx. 10 W (ISO/IEC24712)
	Ready mode	Approx. 4.0 W
	Sleep mode	Approx. 2.0 W
	Power off	Approx. 0.3 W

L555

		100-240 V Model
Input voltage range		90 to 264 V
Rated frequency range		50 to 60 Hz
Input frequency range		49.5 to 60.5 Hz
Rated current		0.5 to 0.3 A
Power consumption	Standalone copying	Approx. 10 W (ISO/IEC24712)
	Ready mode	Approx. 4.5 W
	Sleep mode	Approx. 2.3 W
	Power off	Approx. 0.3 W

Note:

Check the label on the back of the product for its voltage.

Environmental

Temperature	Operation: 10 to 35 °C (50 to 95 °F) Storage: -20 to 40 °C (-4 to 104 °F) 1 month at 40 °C (104 °F)
--------------------	---

Product Information

Humidity	Operation:* 20 to 80% RH Storage:* 5 to 85% RH
-----------------	---

* Without condensation

Standards and approvals

European model:

Low voltage directive 2006/95/EC	EN60950-1
EMC directive 2004/108/EC	EN55022 Class B EN61000-3-2 EN61000-3-3 EN55024
R&TTE directive 1999/5/EC	EN300 328* EN301 489-1* EN301 489-17* TBR21 EN60950-1

* These only applies to the L555.

For European users:

We, Seiko Epson Corporation, hereby declare that the equipment Models, C463A and C463B, are in compliance with the essential requirements and other relevant provisions of Directive 1999/5/EC.

For use only in Ireland, UK, Austria, Germany, Liechtenstein, Switzerland, France, Belgium, Luxembourg, Netherlands, Italy, Portugal, Spain, Denmark, Finland, Norway, Sweden, Iceland, Cyprus, Greece, Slovenia, Malta, Bulgaria, Czech, Estonia, Hungary, Latvia, Lithuania, Poland, Romania, and Slovakia.

Only indoor operation is permitted in France.

If used outside of own premises, general authorization is required in Italy.

Epson can not accept responsibility for any failure to satisfy the protection requirements resulting a non-recommended modification of the products.



Interface

Hi-Speed USB (Device Class for computers)

Where To Get Help

Technical Support Web Site

Epson's Technical Support Web Site provides help with problems that cannot be solved using the troubleshooting information in your product documentation. If you have a Web browser and can connect to the Internet, access the site at:

<http://support.epson.net/>
<http://www.epson.eu/Support> (Europe)

If you need the latest drivers, FAQs, manuals, or other downloadables, access the site at:

<http://www.epson.com>
<http://www.epson.eu/Support> (Europe)

Then, select the support section of your local Epson Web site.

Contacting Epson Support

Before Contacting Epson

If your Epson product is not operating properly and you cannot solve the problem using the troubleshooting information in your product documentation, contact Epson support services for assistance. If Epson support for your area is not listed below, contact the dealer where you purchased your product.

Epson support will be able to help you much more quickly if you give them the following information:

- Product serial number
(The serial number label is usually on the back of the product.)
- Product model
- Product software version
(Click **About**, **Version Info**, or similar button in the product software.)
- Brand and model of your computer
- Your computer operating system name and version
- Names and versions of the software applications you normally use with your product
- Number of sheets of paper fed
 - ➔ [“Checking the Number of Sheets of Paper Fed” on page 91](#)

Where To Get Help

Note:

Depending on the product, the dial list data for fax and/or network settings may be stored in the product's memory. Due to breakdown or repair of a product, data and/or settings may be lost. Epson shall not be responsible for the loss of any data, for backing up or recovering data and/or settings even during a warranty period. We recommend that you make your own backup data or take notes.

Help for Users in Europe

Check your **Pan-European Warranty Document** for information on how to contact Epson support.

Help for Users in Taiwan

Contacts for information, support, and services are:

World Wide Web (<http://www.epson.com.tw>)

Information on product specifications, drivers for download, and products enquiry are available.

Epson HelpDesk (Phone: +0280242008)

Our HelpDesk team can help you with the following over the phone:

- Sales enquiries and product information
- Product usage questions or problems
- Enquiries on repair service and warranty

Repair service center:

Telephone number	Fax number	Address
02-23416969	02-23417070	No.20, Beiping E. Rd., Zhongzheng Dist., Taipei City 100, Taiwan
02-27491234	02-27495955	1F., No.16, Sec. 5, Nanjing E. Rd., Songshan Dist., Taipei City 105, Taiwan
02-32340688	02-32345299	No.1, Ln. 359, Sec. 2, Zhongshan Rd., Zhonghe City, Taipei County 235, Taiwan
039-605007	039-600969	No.342-1, Guangrong Rd., Luodong Township, Yilan County 265, Taiwan
038-312966	038-312977	No.87, Guolian 2nd Rd., Hualien City, Hualien County 970, Taiwan
03-2810606	03-2810707	No.413, Huannan Rd., Pingzhen City, Taoyuan County 324, Taiwan
03-5325077	03-5320092	1F., No.9, Ln. 379, Sec. 1, Jingguo Rd., North Dist., Hsinchu City 300, Taiwan

Where To Get Help

Telephone number	Fax number	Address
04-23291388	04-23291338	3F., No.510, Yingcai Rd., West Dist., Taichung City 403, Taiwan
04-23805000	04-23806000	No.530, Sec. 4, Henan Rd., Nantun Dist., Taichung City 408, Taiwan
05-2784222	05-2784555	No.463, Zhongxiao Rd., East Dist., Chiayi City 600, Taiwan
06-2221666	06-2112555	No.141, Gongyuan N. Rd., North Dist., Tainan City 704, Taiwan
07-5520918	07-5540926	1F., No.337, Minghua Rd., Gushan Dist., Kaohsiung City 804, Taiwan
07-3222445	07-3218085	No.51, Shandong St., Sanmin Dist., Kaohsiung City 807, Taiwan
08-7344771	08-7344802	1F., No.113, Shengli Rd., Pingtung City, Pingtung County 900, Taiwan

Help for Users in Thailand

Contacts for information, support, and services are:

World Wide Web (<http://www.epson.co.th>)

Information on product specifications, drivers for download, Frequently Asked Questions (FAQ), and e-mail are available.

Epson Hotline (Phone: (66)2685-9899)

Our Hotline team can help you with the following over the phone:

- Sales enquiries and product information
- Product usage questions or problems
- Enquiries on repair service and warranty

Help for Users in Vietnam

Contacts for information, support, and services are:

Epson Hotline (Phone): 84-8-823-9239

Service Center: 80 Truong Dinh Street, District 1, Hochiminh City
Vietnam

Help for Users in Indonesia

Contacts for information, support, and services are:

Where To Get Help

World Wide Web (<http://www.epson.co.id>)

- Information on product specifications, drivers for download
- Frequently Asked Questions (FAQ), Sales Enquiries, questions through e-mail

Epson Hotline

- Sales enquiries and product information
- Technical support

Phone (62) 21-572 4350

Fax (62) 21-572 4357

Epson Service Center

Jakarta Mangga Dua Mall 3rd floor No 3A/B
Jl. Arteri Mangga Dua,
Jakarta

Phone/Fax: (62) 21-62301104

Bandung Lippo Center 8th floor
Jl. Gatot Subroto No.2
Bandung

Phone/Fax: (62) 22-7303766

Surabaya Hitech Mall It IIB No. 12
Jl. Kusuma Bangsa 116 – 118
Surabaya

Phone: (62) 31-5355035

Fax: (62)31-5477837

Yogyakarta Hotel Natour Garuda
Jl. Malioboro No. 60
Yogyakarta

Phone: (62) 274-565478

Medan Wisma HSBC 4th floor
Jl. Diponegoro No. 11
Medan

Phone/Fax: (62) 61-4516173

Where To Get Help

Makassar MTC Karebosi Lt. Ill Kav. P7-8
Jl. Ahmad Yani No.49
Makassar
Phone: (62)411-350147/411-350148

Help for Users in Hong Kong

To obtain technical support as well as other after-sales services, users are welcome to contact Epson Hong Kong Limited.

Internet Home Page

Epson Hong Kong has established a local home page in both Chinese and English on the Internet to provide users with the following information:

- Product information
- Answers to Frequently Asked Questions (FAQs)
- Latest versions of Epson product drivers

Users can access our World Wide Web home page at:

<http://www.epson.com.hk>

Technical Support Hotline

You can also contact our technical staff at the following telephone and fax numbers:

Phone: (852) 2827-8911

Fax: (852) 2827-4383

Help for Users in Malaysia

Contacts for information, support, and services are:

World Wide Web (<http://www.epson.com.my>)

- Information on product specifications, drivers for download
- Frequently Asked Questions (FAQ), Sales Enquiries, questions through e-mail

Epson Trading (M) Sdn. Bhd.

Head Office.

Where To Get Help

Phone: 603-56288288

Fax: 603-56288388/399

Epson Helpdesk

- Sales enquiries and product information (Infoline)

Phone: 603-56288222

- Enquiries on repair services & warranty, product usage and technical support (Techline)

Phone: 603-56288333

Help for Users in India

Contacts for information, support, and services are:

World Wide Web (<http://www.epson.co.in>)

Information on product specifications, drivers for download, and products enquiry are available.

Where To Get Help**Epson India Head Office - Bangalore**

Phone: 080-30515000

Fax: 30515005

Epson India Regional Offices:

Location	Telephone number	Fax number
Mumbai	022-28261515 /16/17	022-28257287
Delhi	011-30615000	011-30615005
Chennai	044-30277500	044-30277575
Kolkata	033-22831589 / 90	033-22831591
Hyderabad	040-66331738/ 39	040-66328633
Cochin	0484-2357950	0484-2357950
Coimbatore	0422-2380002	NA
Pune	020-30286000 /30286001/30286002	020-30286000
Ahmedabad	079-26407176 / 77	079-26407347

Helpline

For Service, Product info or to order a cartridge - 18004250011 (9AM - 9PM) - This is a Toll-free number.

For Service (CDMA & Mobile Users) - 3900 1600 (9AM - 6PM) Prefix local STD code

Help for Users in the Philippines

To obtain technical support as well as other after sales services, users are welcome to contact the Epson Philippines Corporation at the telephone and fax numbers and e-mail address below:

Trunk Line: (63-2) 706 2609

Fax: (63-2) 706 2665

Helpdesk Direct Line: (63-2) 706 2625

E-mail: epchelpdesk@epc.epson.com.ph

World Wide Web (<http://www.epson.com.ph>)

Information on product specifications, drivers for download, Frequently Asked Questions (FAQ), and E-mail Enquiries are available.

Toll-Free No. 1800-1069-EPSON(37766)

Where To Get Help

Our Hotline team can help you with the following over the phone:

- Sales enquiries and product information
- Product usage questions or problems
- Enquiries on repair service and warranty

Index**2**

- 2-Sided.....55
- 2-sided printing.....34

A

- Aligning print head.....85
- Auto Answer.....61, 70
- Automatic Document Feeder (ADF).....22
 - paper jams in.....104, 119
 - problems.....119

B

- Banding.....108, 109
- Blank pages.....112
- Blurry prints.....110

C

- Canceling printing.....32
 - Mac OS X.....33
 - Windows.....32
- Cleaning
 - print head.....84
 - product.....91
- Clock.....87
- Color problems.....109
- Contacting Epson.....132
- Copying
 - basic.....26
- Copyright.....2

D

- Date/Time.....87
- Daylight Saving Time.....87
- Documents
 - printing.....29
- Driver.....59
 - accessing for Mac OS X.....28
 - accessing for Windows.....27
 - uninstalling.....96
- DSL.....63

E

- Easy Photo Print.....33
- Enlarging pages.....36
- Envelopes
 - loading.....19
 - printable area.....127
- Epson

- Easy Photo Print.....33
 - paper.....17
- Epson Connect.....8
- Epson Event Manager.....60
- Error messages.....99
- Errors
 - copy.....111
 - fax.....123
 - print.....101
 - scan.....117

F

- Fax from a connected phone.....69
- Fax header.....66
- Fax information service.....71
- Fax Report.....72
- Fax scheduled transmission.....68
- Faxing
 - receiving.....70
- Fit to page printing.....36

G

- Group Dial Setup.....65

H

- Head cleaning
 - control panel.....85
 - Mac OS X.....84
 - Windows.....84
- Header.....66
- Help
 - Epson.....132
 - Epson Event Manager.....60
 - Epson Scan.....59
- Home Mode.....46
- Horizontal banding.....108

I

- Image Adjustment.....43
- Incorrect characters.....110
- Initialize.....122
- Ink
 - precaution.....77
- Ink bottles
 - part numbers.....125
- Interface cables.....131
- ISDN.....63

L

- Lights

Index

- status lights.....117
- Loading
 - paper.....17, 19
- M**
- Mac OS X
 - accessing printer settings.....28
 - checking product status.....102
- Managing print jobs
 - Windows.....101
- Margins
 - problems.....111
- Marquee.....53
- Mirror image.....111
- Misalignment.....109
- Multiple pages per sheet.....37
- N**
- Nozzle check.....82
 - control panel.....83
 - Mac OS X.....82
 - Windows.....82
- O**
- Office Mode.....48
- P**
- Pages per sheet printing.....37
- Paper
 - Epson special paper.....17
 - feeding problems.....113
 - jams.....103
 - loading.....19
 - loading capacity.....17
 - printable area.....127
 - specifications.....126
 - wrinkling.....114
- Paper jam.....103, 119
- PDF.....55
- Photo
 - software.....33
- Polling.....71
- Previewing.....52
- Print head
 - aligning.....85
 - checking.....82
 - cleaning.....84
- Print quality
 - improving.....107
- Print speed
 - increasing.....112, 115
- Printable area specifications.....127
- Printing
 - 2-sided.....34
 - canceling.....32
 - fit to page.....36
 - multiple pages per sheet.....37
 - preset.....34
 - shortcut.....34
 - text.....29
- Problems
 - banding.....108, 109
 - blank pages.....112
 - blurry prints.....110
 - contacting Epson.....132
 - diagnosing.....101
 - fax.....123
 - incorrect characters.....110
 - incorrect colors.....109
 - margins.....111
 - mirror image.....111
 - paper feeding.....113
 - paper jams.....103
 - print.....101
 - print speed.....112
 - product does not print.....114
 - scan.....117
 - smear prints.....110, 112
 - solving.....132
- Product
 - checking status.....101
 - cleaning.....91
 - parts.....13
 - transporting.....92
- Product settings
 - accessing for Mac OS X.....28
 - accessing for Windows.....27
 - Power Off Timer.....90
 - Sleep Timer.....90
- Professional Mode.....50
- R**
- Redial.....67
- Reducing page size.....36
- Refilling the ink tanks.....78
- Resizing pages.....36
- Restrictions on copying.....12
- Rings to Answer.....70
- S**
- Safety information.....9
- Saving energy.....90
- Scan quality problems.....120
- Scanner glass.....24
- Scanning software
 - bundle software.....60
- Send Fax Later.....68
- Service.....132
- Sharing printer
 - Mac OS X.....40
 - Windows.....38
- Smear prints.....110, 112
- Software
 - uninstalling.....96
- Specifications

automatic document feeder.....	128
fax.....	128
ink bottles.....	125
mechanical.....	129
paper.....	126
printer.....	126
scanner.....	128
standards and approvals.....	131
Speed	
increasing.....	112, 115
Speed Dial Setup.....	65
Status lights.....	117
Status Monitor	
Mac OS X.....	102
System requirements.....	125
T	
Technical support.....	132
Text	
printing documents.....	29
Trademarks.....	2
Transporting product.....	92
U	
USB	
connector.....	131
W	
Web service.....	8
Windows	
accessing printer settings.....	27
checking product status.....	101
managing print jobs.....	101