

# User's Guide

## Copyright

# Copyright

No part of this publication may be reproduced, stored in a retrieval system, or transmitted in any form or by any means, electronic, mechanical, photocopying, recording, or otherwise, without the prior written permission of Seiko Epson Corporation. No patent liability is assumed with respect to the use of the information contained herein. Neither is any liability assumed for damages resulting from the use of the information herein. The information contained herein is designed only for use with this Epson product. Epson is not responsible for any use of this information as applied to other products.

Neither Seiko Epson Corporation nor its affiliates shall be liable to the purchaser of this product or third parties for damages, losses, costs, or expenses incurred by the purchaser or third parties as a result of accident, misuse, or abuse of this product or unauthorized modifications, repairs, or alterations to this product, or (excluding the U.S.) failure to strictly comply with Seiko Epson Corporation's operating and maintenance instructions.

Seiko Epson Corporation and its affiliates shall not be liable for any damages or problems arising from the use of any options or any consumable products other than those designated as Original Epson Products or Epson Approved Products by Seiko Epson Corporation.

Seiko Epson Corporation shall not be held liable for any damage resulting from electromagnetic interference that occurs from the use of any interface cables other than those designated as Epson Approved Products by Seiko Epson Corporation.

© 2014 Seiko Epson Corporation. All rights reserved.

The contents of this manual and the specifications of this product are subject to change without notice.

# Trademarks

- ❑ EPSON® is a registered trademark, and EPSON EXCEED YOUR VISION or EXCEED YOUR VISION is a trademark of Seiko Epson Corporation.
- ❑ PRINT Image Matching™ and the PRINT Image Matching logo are trademarks of Seiko Epson Corporation. Copyright © 2001 Seiko Epson Corporation. All rights reserved.
- ❑ EPSON Scan software is based in part on the work of the Independent JPEG Group.

- ❑ libtiff

Copyright © 1988-1997 Sam Leffler

Copyright © 1991-1997 Silicon Graphics, Inc.

Permission to use, copy, modify, distribute, and sell this software and its documentation for any purpose is hereby granted without fee, provided that (i) the above copyright notices and this permission notice appear in all copies of the software and related documentation, and (ii) the names of Sam Leffler and Silicon Graphics may not be used in any advertising or publicity relating to the software without the specific, prior written permission of Sam Leffler and Silicon Graphics.

THE SOFTWARE IS PROVIDED "AS-IS" AND WITHOUT WARRANTY OF ANY KIND, EXPRESS, IMPLIED OR OTHERWISE, INCLUDING WITHOUT LIMITATION, ANY WARRANTY OF MERCHANTABILITY OR FITNESS FOR A PARTICULAR PURPOSE.

IN NO EVENT SHALL SAM LEFFLER OR SILICON GRAPHICS BE LIABLE FOR ANY SPECIAL, INCIDENTAL, INDIRECT OR CONSEQUENTIAL DAMAGES OF ANY KIND, OR ANY DAMAGES WHATSOEVER RESULTING FROM LOSS OF USE, DATA OR PROFITS, WHETHER OR NOT ADVISED OF THE POSSIBILITY OF DAMAGE, AND ON ANY THEORY OF LIABILITY, ARISING OUT OF OR IN CONNECTION WITH THE USE OR PERFORMANCE OF THIS SOFTWARE.

- ❑ Microsoft®, Windows®, and Windows Vista® are registered trademarks of Microsoft Corporation.
- ❑ Apple, Macintosh, Mac OS, OS X, are trademarks of Apple Inc., registered in the U.S. and other countries.
- ❑ Adobe, Adobe Reader, Acrobat, and Photoshop are trademarks of Adobe systems Incorporated, which may be registered in certain jurisdictions.
- ❑ Intel® is a registered trademark of Intel Corporation.
- ❑ General Notice: Other product names used herein are for identification purposes only and may be trademarks of their respective owners. Epson disclaims any and all rights in those marks.

## Contents

### Copyright

### Trademarks

### About This Manual

Introduction to the Manuals. . . . .	6
Marks and Symbols. . . . .	6
Descriptions Used in this Manual. . . . .	6
Operating System References. . . . .	7

### Important Instructions

Safety Instructions. . . . .	8
Printer Advisories and Warnings. . . . .	8
Advisories and Warnings for Setting Up/ Using the Printer. . . . .	8

### Printer Basics

Part Names and Functions. . . . .	10
Buttons. . . . .	12

### Loading Paper

Paper Handling Precautions. . . . .	14
Available Paper and Capacities. . . . .	15
List of Paper Types. . . . .	15
Loading Paper in the Rear Paper Feed. . . . .	16

### Placing Originals on the Scanner Glass

### Printing

Printing from a Computer. . . . .	21
Printing Basics - Windows. . . . .	21
Printing Basics - Mac OS X. . . . .	22
Printing on 2-Sides (for Windows only). . . . .	24
Printing Several Pages on One Sheet. . . . .	25
Printing to Fit the Paper Size. . . . .	26
Printing Multiple Files Together (for Windows Only). . . . .	27
Enlarged Printing and Making Posters (for Windows Only). . . . .	28
Printing Using Advanced Features. . . . .	34
Printing Photos Using Epson Easy Photo Print. . . . .	36

Canceling Printing. . . . .	36
Canceling Printing - Printer Button. . . . .	36
Canceling Printing - Windows. . . . .	36
Canceling Printing - Mac OS X. . . . .	37

### Copying

Copying Basics. . . . .	38
Making Multiple Copies. . . . .	38

### Scanning

Scanning from the Control Panel. . . . .	39
Scanning from a Computer. . . . .	39
Scanning Basics. . . . .	39
Scanning Using Advanced Features. . . . .	42

### Refilling Ink

Checking the Ink Levels - Tank. . . . .	45
Ink Bottle Codes. . . . .	45
Ink Bottle Handling Precautions. . . . .	45
Refilling the Ink Tanks. . . . .	46

### Improving Print and Scan Quality

Checking and Cleaning the Print Head. . . . .	50
Checking and Cleaning the Print Head - Printer Buttons. . . . .	50
Checking and Cleaning the Print Head - Windows. . . . .	51
Checking and Cleaning the Print Head - Mac OS X. . . . .	51
Replacing Ink inside the Ink Tubes. . . . .	52
Replacing Ink inside the Ink Tubes - Windows. . . . .	52
Replacing Ink inside the Ink Tubes - Mac OS X. . . . .	52
Aligning the Print Head. . . . .	53
Aligning the Print Head - Windows. . . . .	53
Aligning the Print Head - Mac OS X. . . . .	53
Cleaning the Paper Path. . . . .	53
Cleaning the Scanner Glass. . . . .	54

### Application Information

Necessary Applications. . . . .	55
Windows Printer Driver. . . . .	55
Mac OS X Printer Driver. . . . .	58
EPSON Scan (Scanner Driver). . . . .	61

## Contents

Epson Event Manager. . . . .	61	Moire (Cross-Hatch) Patterns Appear in the Scanned Image. . . . .	77
Epson Easy Photo Print. . . . .	62	Scanning Area or Direction Is Not Correct. . . . .	77
E-Web Print (for Windows Only). . . . .	62	The Scanned Image Problem Could Not be Cleared. . . . .	77
EPSON Software Updater. . . . .	62	Other Scanning Problems. . . . .	78
Uninstalling Applications. . . . .	63	Cannot Scan in Full Auto Mode in EPSON Scan. . . . .	78
Uninstalling Applications - Windows. . . . .	63	Thumbnail Preview Does Not Work Properly. . . . .	78
Uninstalling Applications - Mac OS X. . . . .	63	Scanning Is Too Slow. . . . .	78
Installing Applications. . . . .	64	Scanning Stops when Scanning to PDF/Multi-TIFF. . . . .	78
Updating Applications and Firmware. . . . .	64	Other Problems. . . . .	78
<b>Solving Problems</b>		Slight Electric Shock when Touching the Printer. . . . .	78
Checking the Printer Status. . . . .	66	Operation Sounds Are Loud. . . . .	78
Checking the Error Indicators on the Printer. . . . .	66	Application Is Blocked by a Firewall (for Windows Only). . . . .	79
Checking the Printer Status - Windows. . . . .	67		
Checking Printer Status - Mac OS X. . . . .	67	<b>Appendix</b>	
Removing Jammed Paper. . . . .	67	Technical Specifications. . . . .	80
Removing Jammed Paper from the Rear Paper Feed. . . . .	68	Printer Specifications. . . . .	80
Removing Jammed Paper from Inside the Printer. . . . .	68	Scanner Specifications. . . . .	80
Paper Does Not Feed Correctly. . . . .	70	Interface Specifications. . . . .	81
Power and Control Panel Problems. . . . .	70	Dimensions. . . . .	81
Power Does Not Turn On. . . . .	70	Electrical Specifications. . . . .	81
Power Does Not Turn Off. . . . .	70	Environmental Specifications. . . . .	82
Printer Does Not Print. . . . .	70	System Requirements. . . . .	82
Printout Problems. . . . .	71	Regulatory Information. . . . .	83
Print Quality Is Poor. . . . .	71	Standards and Approvals for European Model. . . . .	83
Copy Quality Is Poor. . . . .	72	Restrictions on Copying. . . . .	83
An Image of the Reverse Side of the Original Appears in the Copied Image. . . . .	73	Checking the Total Number of Pages Fed Through the Printer. . . . .	83
The Position, Size, or Margins of the Printout Are Incorrect. . . . .	73	Checking the Total Number of Pages Fed Through the Printer - Control Panel. . . . .	83
Paper Is Smearred or Scuffed. . . . .	73	Checking the Total Number of Pages Fed Through the Printer - Windows. . . . .	84
Printed Characters Are Incorrect or Garbled. . . . .	74	Checking the Total Number of Pages Fed Through the Printer - Mac OS X. . . . .	84
The Printed Image Is Inverted. . . . .	74	Saving Power. . . . .	84
The Printout Problem Could Not be Cleared. . . . .	74	Saving Power - Windows. . . . .	84
Other Printing Problems. . . . .	74	Saving Power - Mac OS X. . . . .	84
Printing Is Too Slow. . . . .	74	Transporting the Printer. . . . .	85
Printing Slows Down Dramatically During Continuous Printing. . . . .	75	Where to Get Help. . . . .	87
Cannot Start Scanning. . . . .	75	Technical Support Web Site. . . . .	87
Cannot Start Scanning when Using the Control Panel. . . . .	76	Contacting Epson Support. . . . .	87
Scanned Image Problems. . . . .	76		
Scan Quality Is Poor. . . . .	76		
Characters Are Blurred. . . . .	76		
An Image of the Reverse Side of the Original Appears in the Scanned Image. . . . .	77		

# About This Manual

---

## Introduction to the Manuals

The latest versions of the following manuals are available from the Epson support website.

<http://www.epson.eu/Support> (Europe)

<http://support.epson.net/> (outside Europe)

Start Here (paper manual)

Provides you with information on setting up the printer, installing the software, using the printer basically, solving problems, and so on.

User's Guide (PDF manual)

This manual. Provides overall information and instructions on using the printer, and on solving problems.

As well as the manuals above, see the help included in the various Epson software applications.

---

## Marks and Symbols



**Caution:**

*Instructions that must be followed carefully to avoid bodily injury.*



**Important:**

*Instructions that must be observed to avoid damage to your equipment.*

**Note:**

*Provides complementary and reference information.*

**➔** Related Information

Links to related sections.

---

## Descriptions Used in this Manual

- Screenshots of the printer driver and the EPSON Scan (scanner driver) screens are from Windows 8.1 or Mac OS X v10.9.x. The content displayed on the screens varies depending on the model and situation.
- Illustrations of the printer used in this manual are examples only. Although there may be slight differences depending on the model, the method of operation is the same.

---

## Operating System References

### Windows

In this manual, terms such as "Windows 8.1", "Windows 8", "Windows 7", "Windows Vista", and "Windows XP" refer to the following operating systems. Additionally, "Windows" is used to refer to all versions.

- Microsoft® Windows® 8.1 operating system
- Microsoft® Windows® 8 operating system
- Microsoft® Windows® 7 operating system
- Microsoft® Windows Vista® operating system
- Microsoft® Windows® XP operating system
- Microsoft® Windows® XP Professional x64 Edition operating system

### Mac OS X

In this manual, "Mac OS X v10.9.x" refers to "OS X Mavericks" and "Mac OS X v10.8.x" refers to "OS X Mountain Lion". Additionally, "Mac OS X" is used to refer to "Mac OS X v10.9.x", "Mac OS X v10.8.x", "Mac OS X v10.7.x" and "Mac OS X v10.6.8".

# Important Instructions

---

## Safety Instructions

Read and follow these instructions to ensure safe use of this printer. Make sure you keep this manual for future reference. Also, be sure to follow all warnings and instructions marked on the printer.

- Use only the power cord supplied with the printer and do not use the cord with any other equipment. Use of other cords with this printer or the use of the supplied power cord with other equipment may result in fire or electric shock.
- Be sure your AC power cord meets the relevant local safety standard.
- Never disassemble, modify, or attempt to repair the power cord, plug, printer unit, scanner unit, or options by yourself, except as specifically explained in the printer's manuals.
- Unplug the printer and refer servicing to qualified service personnel under the following conditions:  
The power cord or plug is damaged; liquid has entered the printer; the printer has been dropped or the casing damaged; the printer does not operate normally or exhibits a distinct change in performance. Do not adjust controls that are not covered by the operating instructions.
- Place the printer near a wall outlet where the plug can be easily unplugged.
- Do not place or store the printer outdoors, near excessive dirt or dust, water, heat sources, or in locations subject to shocks, vibrations, high temperature or humidity.
- Take care not to spill liquid on the printer and not to handle the printer with wet hands.
- Be careful not to touch any ink when you handle the ink tanks, ink tank caps, and opened ink bottles or ink bottle caps.
  - If ink gets on your skin, wash the area thoroughly with soap and water.
  - If ink gets into your eyes, flush them immediately with water. If discomfort or vision problems continue after a thorough flushing, see a doctor immediately.
  - If ink gets into your mouth, see a doctor right away.
- Do not tilt or shake an ink bottle after removing its seal; this can cause leakage.
- Keep ink bottles and the ink tank unit out of the reach of children. Do not allow children to drink from or handle the ink bottles and ink bottle cap.

---

## Printer Advisories and Warnings



Read and follow these instructions to avoid damaging the printer or your property. Make sure you keep this manual for future reference.

### Advisories and Warnings for Setting Up/Using the Printer

- Do not block or cover the vents and openings in the printer.
- Use only the type of power source indicated on the printer's label.
- Avoid using outlets on the same circuit as photocopiers or air control systems that regularly switch on and off.
- Avoid electrical outlets controlled by wall switches or automatic timers.



## Important Instructions

- ❑ Keep the entire computer system away from potential sources of electromagnetic interference, such as loudspeakers or the base units of cordless telephones.
- ❑ The power-supply cords should be placed to avoid abrasions, cuts, fraying, crimping, and kinking. Do not place objects on top of the power-supply cords and do not allow the power-supply cords to be stepped on or run over. Be particularly careful to keep all the power-supply cords straight at the ends and the points where they enter and leave the transformer.
- ❑ If you use an extension cord with the printer, make sure that the total ampere rating of the devices plugged into the extension cord does not exceed the cord's ampere rating. Also, make sure that the total ampere rating of all devices plugged into the wall outlet does not exceed the wall outlet's ampere rating.
- ❑ If you plan to use the printer in Germany, the building installation must be protected by a 10 or 16 amp circuit breaker to provide adequate short-circuit protection and over-current protection for the printer.
- ❑ When connecting the printer to a computer or other device with a cable, ensure the correct orientation of the connectors. Each connector has only one correct orientation. Inserting a connector in the wrong orientation may damage both devices connected by the cable.
- ❑ Place the printer on a flat, stable surface that extends beyond the base of the printer in all directions. The printer will not operate properly if it is tilted at an angle.
- ❑ When storing or transporting the printer, avoid tilting it, placing it vertically, or turning it upside down; otherwise ink may leak.
- ❑ Allow space above the printer so that you can fully raise the document cover.
- ❑ Leave enough space in front of the printer for the paper to be fully ejected.
- ❑ Avoid places subject to rapid changes in temperature and humidity. Also, keep the printer away from direct sunlight, strong light, or heat sources.
- ❑ Do not insert objects through the slots in the printer.
- ❑ Do not put your hand inside the printer during printing.
- ❑ Do not touch the white flat cable and ink tubes inside the printer.
- ❑ Do not use aerosol products that contain flammable gases inside or around the printer. Doing so may cause fire.
- ❑ Do not move the print head by hand; otherwise, you may damage the printer.
- ❑ Be careful not to trap your fingers when closing the scanner unit.
- ❑ Do not press too hard on the scanner glass when placing the originals.
- ❑ If any of the ink tanks are not filled up to the lower line, refill the ink soon. Continued use of the printer when the ink level is below the lower line on the tanks could damage the printer.
- ❑ Always turn the printer off using the  button. Do not unplug the printer or turn off the power at the outlet until the  light stops flashing.
- ❑ Before transporting the printer, make sure that the print head is in the home (far right) position.
- ❑ If you are not going to use the printer for a long period, be sure to unplug the power cord from the electrical outlet.

# Printer Basics

## Part Names and Functions

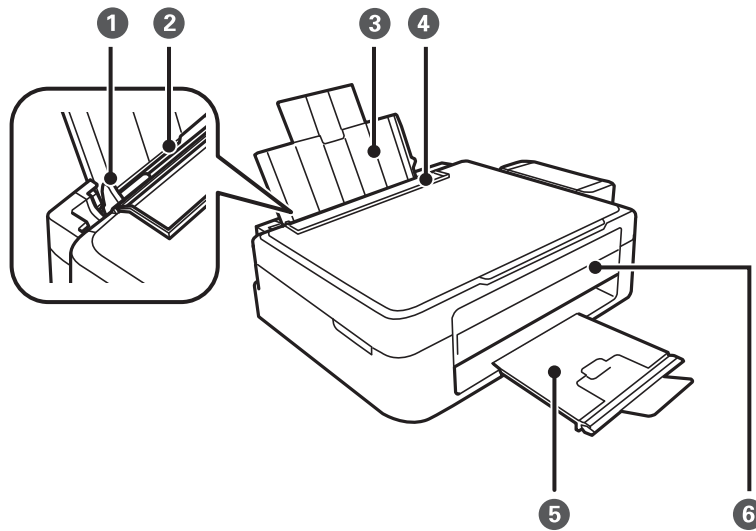

1	Edge guide	Feeds the paper straight into the printer. Slide to the edges of the paper.
2	Rear paper feed	Loads paper.
3	Paper support	Supports loaded paper.
4	Feeder guard	Prevents foreign substance from entering the printer. Usually keep this guard closed.
5	Output tray	Holds the ejected paper. Before printing, raise the stopper to prevent the ejected paper from falling off the tray.
6	Control panel	Operates the printer.

### Printer Basics

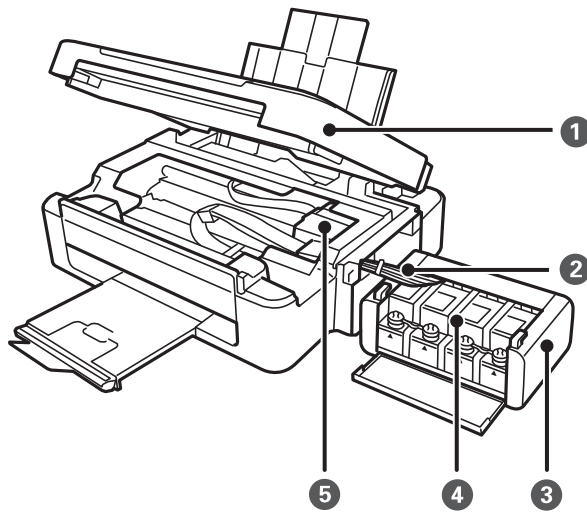

1	Scanner unit	Scans placed originals. Open when removing jammed paper inside the printer.
2	Ink tube	Supplies ink to the print head.
3	Ink tank unit	Contains the ink tanks.
4	Ink reservoir tanks (Ink tanks)	Supplies ink to the ink tubes.
5	Print head	Fires ink.

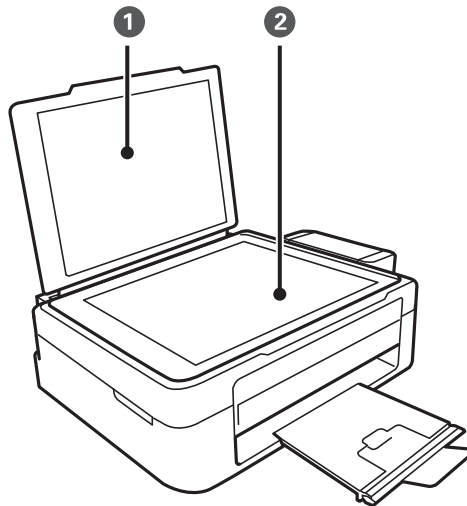

1	Document cover	Blocks external light while scanning.
2	Scanner glass	Place the originals.



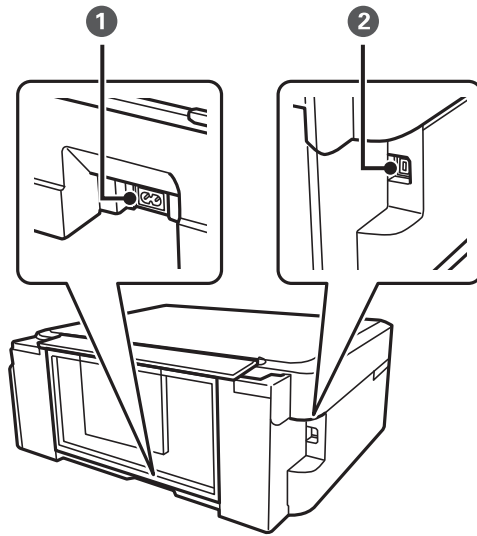



### Printer Basics

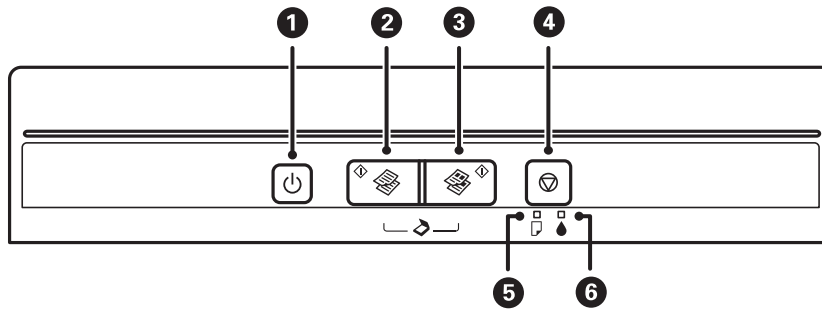

1	AC inlet	Connects the power cord.
2	USB port	Connects a USB cable.

## Buttons











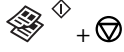

1		<p>Turns the printer on or off.</p> <p>Do not turn off while the power light is flashing (while the printer is operating or processing data).</p> <p>Unplug the power cord when the power light is off.</p>
2		<p>Starts monochrome copying on A4 size plain paper.</p>
3		<p>Starts color copying on A4 size plain paper.</p>
4		<p>Stops the current operation.</p> <p>Hold this button down for three seconds until the  button flashes to run print head cleaning.</p>
5		<p>Turns on or flashes when paper is out or a paper jam occurs.</p>

## Printer Basics

6		Indicates the status of the initial ink charging.
---	---	---

Additional functions are available with different combinations of buttons.

	Press the  and  buttons simultaneously to start monochrome copying in draft mode.
	Press the  and  buttons simultaneously to start color copying in draft mode.
	Press the  and  buttons simultaneously to run software on a USB-connected computer and scan as a PDF file.
	Turn the printer on while holding down the  button to print the nozzle check pattern.

### Related Information

➔ [“Checking the Error Indicators on the Printer” on page 66](#)

# Loading Paper

## Paper Handling Precautions

- ❑ Read the instruction sheets supplied with the paper.
- ❑ Fan and align the edges of the paper before loading. Do not fan or curl photo paper. Doing so may damage the printable side.

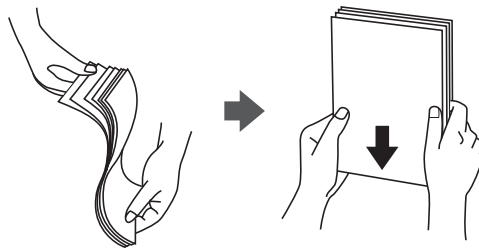

- ❑ If the paper is curled, flatten it or curl it slightly in the opposite direction before loading. Printing on curled paper may cause paper jams and smears on the printout.

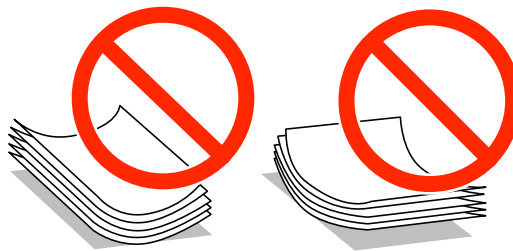

- ❑ Do not use paper that is wavy, torn, cut, folded, damp, too thick, too thin, or paper that has stickers stuck to it. Using these types of paper causes paper jams and smears on the printout.
- ❑ Fan and align the edges of the envelopes before loading. When the stacked envelopes are puffed up with air, press them down to flatten them before loading.

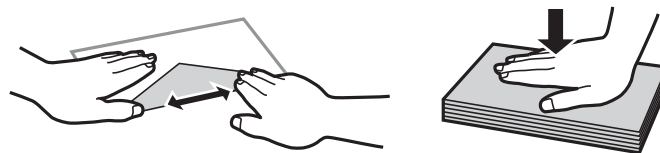

- ❑ Do not use envelopes that are curled or folded. Using these envelopes causes paper jams and smears on the printout.
- ❑ Do not use envelopes with adhesive surfaces on the flaps or window envelopes.
- ❑ Avoid using envelopes that are too thin, as they may curl during printing.

### Related Information

- ➔ [“Printer Specifications” on page 80](#)

## Available Paper and Capacities

Epson recommends using genuine Epson paper to ensure high-quality printouts.

### Genuine Epson Paper

Media Name	Size	Loading Capacity (Sheets)	Manual 2-Sided Printing
Epson Bright White Ink Jet Paper	A4	40 <sup>*1</sup>	✓
Epson Premium Glossy Photo Paper <sup>*2</sup>	A4, 13 × 18 cm (5 × 7 in.), 16:9 wide size (102 × 181 mm), 10 × 15 cm (4 × 6 in.)	10	-
Epson Matte Paper-Heavyweight <sup>*2</sup>	A4	20	-
Epson Photo Quality Ink Jet Paper <sup>*2</sup>	A4	40	-

\*1 For manual 2-sided printing, you can load up to 15 sheets for paper with one side already printed.

\*2 Only printing from computer is available.

**Note:**

*The availability of paper varies by location. For the latest information on paper available in your area, contact Epson support.*

### Commercially Available Paper

Media Name	Size	Loading Capacity (Sheets)	Manual 2-Sided Printing
Plain paper	Letter <sup>*1</sup> , A4, B5 <sup>*1</sup> , A5 <sup>*1</sup> , A6 <sup>*1</sup>	Up to the line indicated by the triangle symbol on the edge guide. <sup>*2</sup>	✓
	Legal <sup>*1</sup> , User Defined <sup>*1</sup>	1	
Envelope <sup>*1</sup>	Envelope #10, Envelope DL, Envelope C6	5	-

\*1 Only printing from computer is available.

\*2 For manual 2-sided printing, you can load up to 15 sheets for paper with one side already printed.

### Related Information

➔ [“Technical Support Web Site” on page 87](#)

## List of Paper Types

To obtain optimum printing results, select the paper type that suits the paper.

## Loading Paper

Media Name	Media Type
Epson Bright White Ink Jet Paper*	plain papers
Epson Premium Glossy Photo Paper*	Epson Premium Glossy
Epson Matte Paper-Heavyweight*	Epson Matte
Epson Photo Quality Ink Jet Paper*	Epson Matte
Plain paper*	plain papers
Envelope	Envelope

\* These paper types are compatible with Exif Print and PRINT Image Matching when printed by the printer driver. For more information, see the documentation that came with the Exif Print or PRINT Image Matching compatible digital camera.

## Loading Paper in the Rear Paper Feed

1. Open the feeder guard, extend the paper support, and then tilt it backwards.

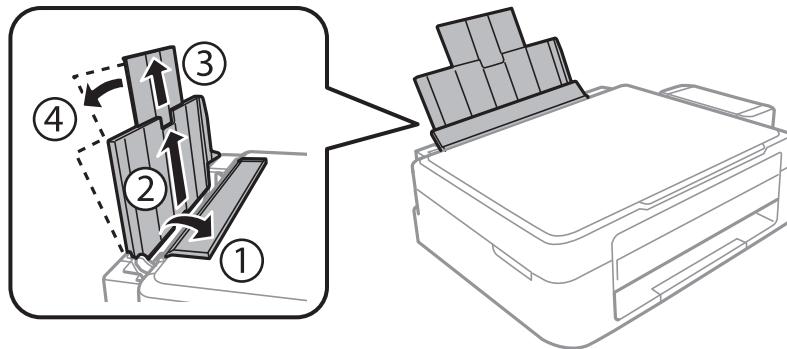

2. Slide the edge guide to the left.

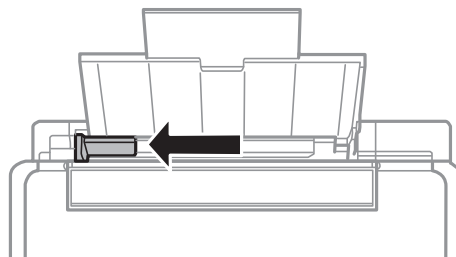



## Loading Paper

3. Load paper vertically along the right side of the rear paper feed with the printable side facing up.

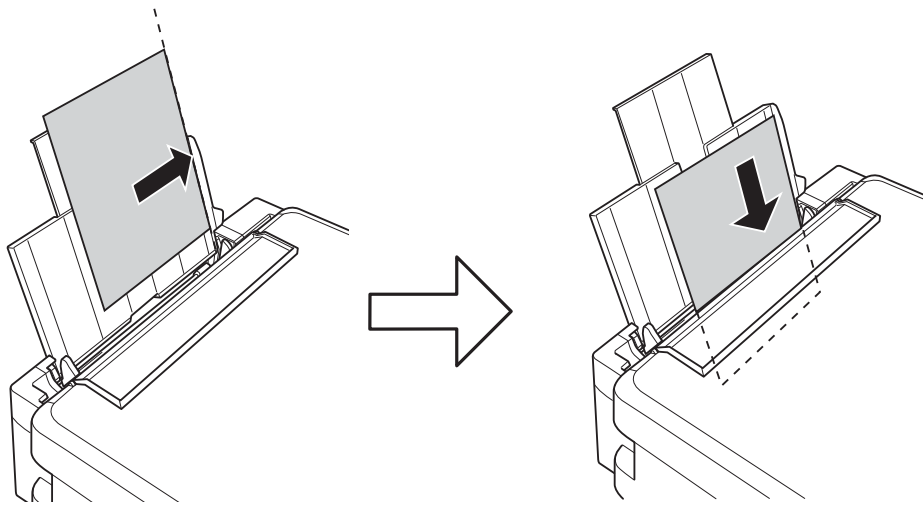

**Important:**

Do not load more than the maximum number of sheets specified for the paper. For plain paper, do not load above the line indicated by the triangle symbol on the edge guide.

- ❑ Envelopes

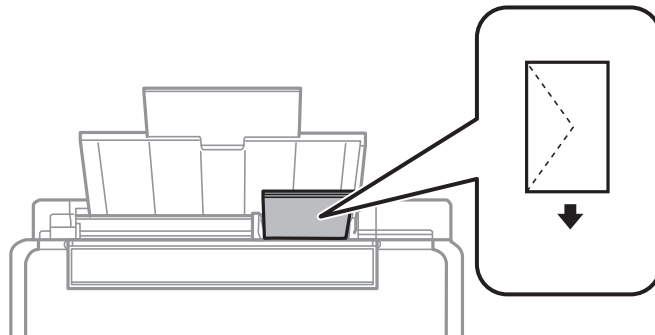

- ❑ Pre-punched paper

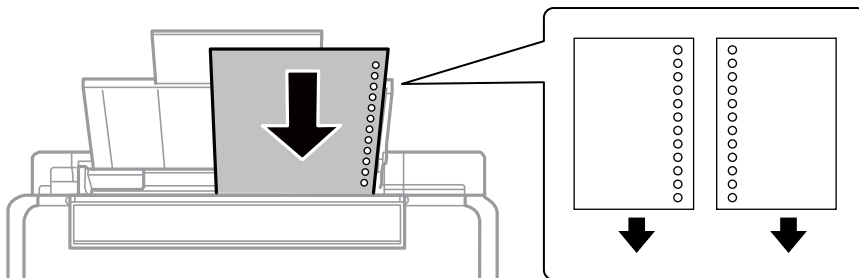

**Note:**

- ❑ Load a single sheet of paper without binding holes at the top or the bottom.
- ❑ Adjust the print position of your file to avoid printing over the holes.

## Loading Paper

- Slide the edge guide to the edge of the paper, and then close the feeder guard.

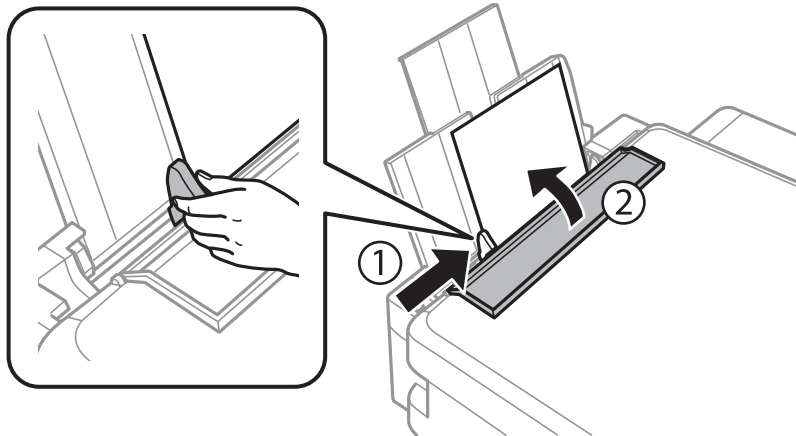

- Slide out the output tray.

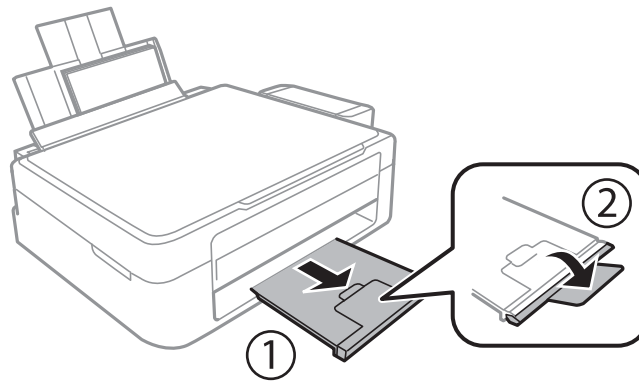

**Note:**

Return the remaining paper to its package. If you leave it in the printer, the paper may curl or the print quality may decline.

### Related Information

- ➔ [“Paper Handling Precautions” on page 14](#)
- ➔ [“Available Paper and Capacities” on page 15](#)

## Placing Originals on the Scanner Glass

# Placing Originals on the Scanner Glass



**Important:**

*When placing bulky originals such as books, prevent exterior light from shining directly onto the scanner glass.*

1. Open the document cover.

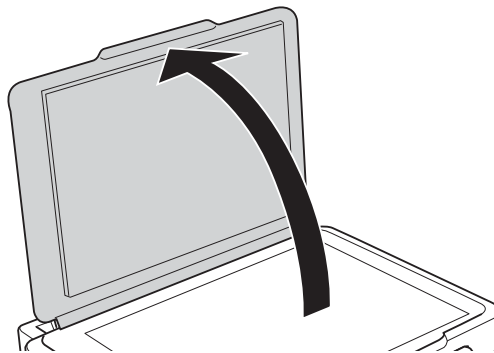

2. Remove any dust or stains on the scanner glass.
3. Place the original face-down and slide it to the corner mark.

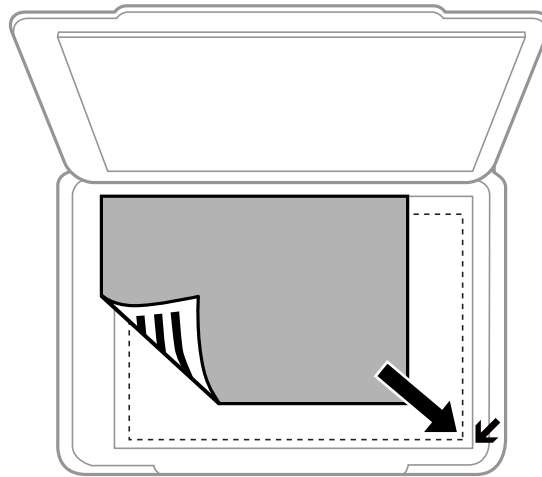

**Note:**

*The area 1.5 mm from the edges of the scanner glass is not scanned.*

### Placing Originals on the Scanner Glass

If you are scanning using **Full Auto Mode** or a thumbnail preview of EPSON Scan, place the original 4.5 mm away from the horizontal and vertical edges of the scanner glass.

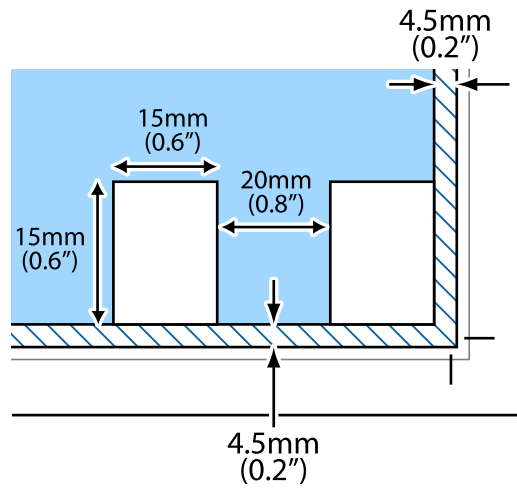

**Note:**

- ❑ Place multiple photos at least 20 mm apart from each other.
- ❑ The photos should be larger than 15 x 15 mm.

4. Close the cover gently.

**Note:**

Remove the originals after scanning or copying. If you leave the originals on the scanner glass for a long time, they may stick to the surface of the glass.

# Printing

## Printing from a Computer

### Printing Basics - Windows

**Note:**

- ❑ See the online help for explanations of the setting items. Right-click an item, and then click **Help**.
- ❑ Operations differ depending on the application. See the application's help for details.

1. Load paper in the printer.
2. Open the file you want to print.
3. Select **Print** or **Print Setup** from the **File** menu.
4. Select your printer.
5. Select **Preferences** or **Properties** to access the printer driver window.

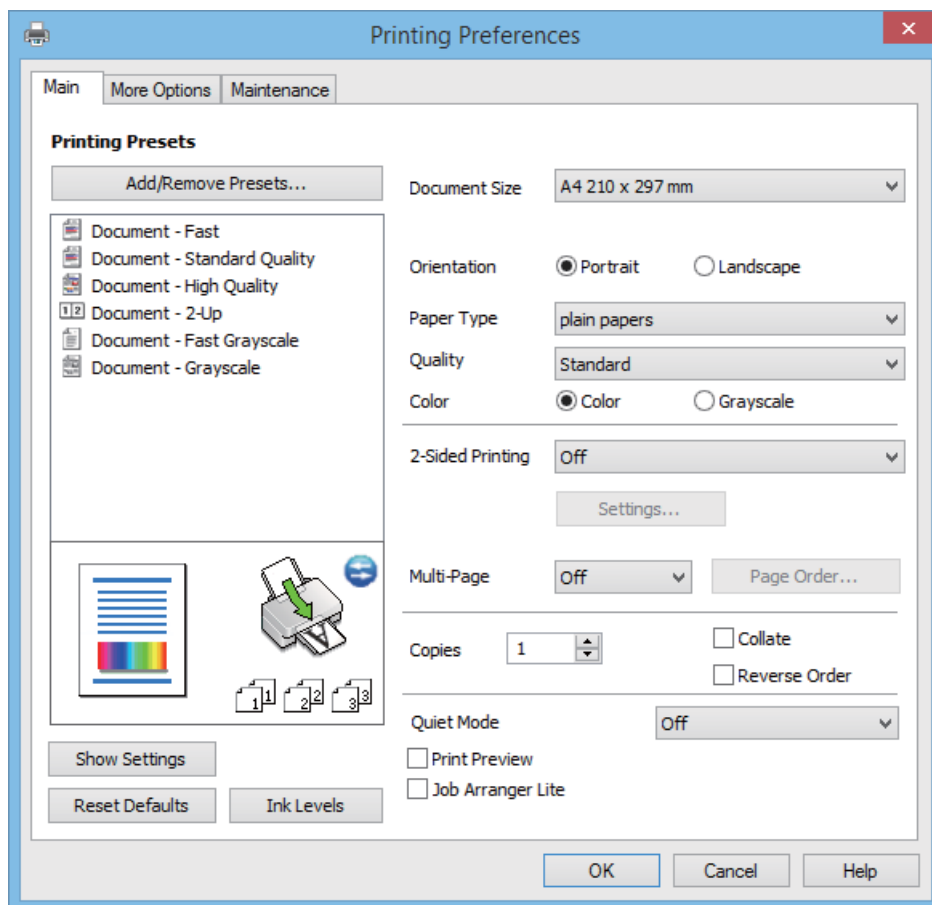

6. Make the following settings.
  - ❑ Document Size: Select the paper size you loaded in the printer.

## Printing

- Orientation: Select the orientation you set in the application.
- Paper Type: Select the type of paper you loaded.
- Color: Select **Grayscale** when you want to print in black or shades of gray.

**Note:**

When printing on envelopes, select **Landscape** as the **Orientation** setting.

7. Click **OK** to close the printer driver window.
8. Click **Print**.

### Related Information

- ➔ [“Available Paper and Capacities” on page 15](#)
- ➔ [“Loading Paper in the Rear Paper Feed” on page 16](#)
- ➔ [“Guide to Windows Printer Driver” on page 56](#)
- ➔ [“List of Paper Types” on page 15](#)

## Printing Basics - Mac OS X

**Note:**

Operations differ depending on the application. See the application's help for details.

1. Load paper in the printer.
2. Open the file you want to print.
3. Select **Print** from the **File** menu or another command to access the print dialog.

If necessary, click **Show Details** or ▼ to expand the print window.

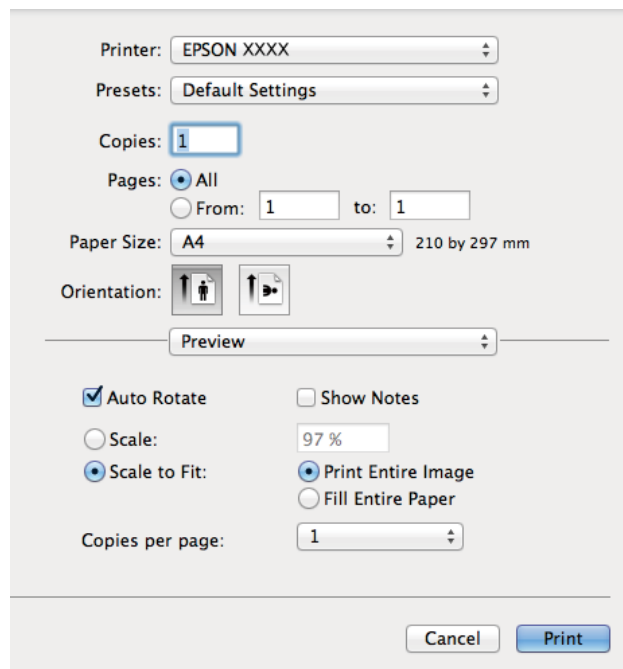

## Printing

4. Make the following settings.

- Printer: Select your printer.
- Preset: Select when you want to use the registered settings.
- Paper Size: Select the paper size you loaded in the printer.
- Orientation: Select the orientation you set in the application.

**Note:**

*When printing on envelopes, select landscape orientation*

5. Select **Print Settings** from the pop-up menu.

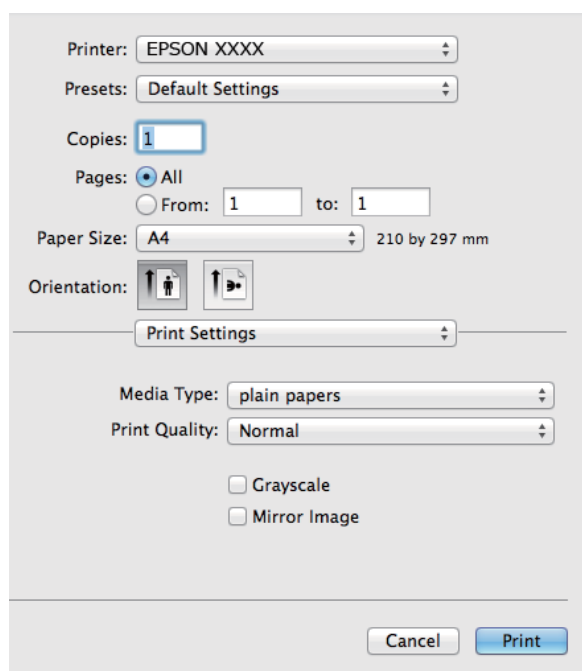

**Note:**

*On Mac OS X v10.8.x or later, if the **Print Settings** menu is not displayed, the Epson printer driver has not been installed correctly.*

Select **System Preferences** from the  menu > **Printers & Scanners** (or **Print & Scan**, **Print & Fax**), remove the printer, and then add the printer again. See the following to add a printer.

<http://epson.sn>

6. Make the following settings.

- Media Type: Select the type of paper you loaded.
- Grayscale: Select to print in black or shades of gray.

7. Click **Print**.

### Related Information

- ➔ [“Available Paper and Capacities” on page 15](#)
- ➔ [“Loading Paper in the Rear Paper Feed” on page 16](#)
- ➔ [“Guide to Mac OS X Printer Driver” on page 59](#)
- ➔ [“List of Paper Types” on page 15](#)

## Printing

### Printing on 2-Sides (for Windows only)

The printer driver prints automatically separating even pages and odd pages. When the printer has finished printing the odd pages, flip the paper over following the instructions to print the even pages. You can also print a booklet that can be created by folding the printout.

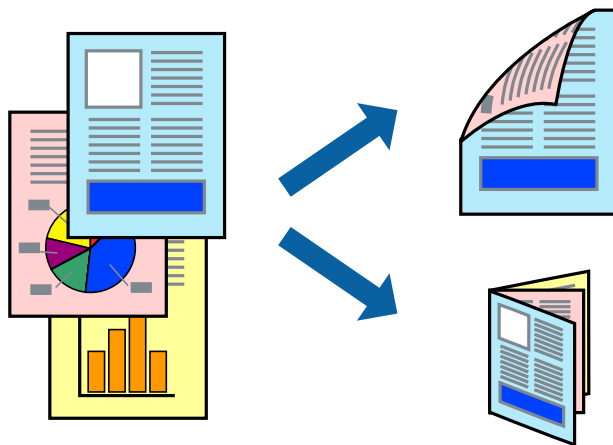

**Note:**

- If you do not use paper that is suitable for 2-sided printing, the print quality may decline and paper jams may occur.
- Depending on the paper and the data, ink may bleed through to the other side of the paper.
- If **EPSON Status Monitor 3** is disabled, access the printer driver, click **Extended Settings** on the **Maintenance** tab, and then select **Enable EPSON Status Monitor 3**.
- 2-sided printing may not be available when the printer is accessed over a network or is used as a shared printer.

1. Load paper in the printer.
2. Open the file you want to print.
3. Access the printer driver window.
4. Select **Manual (Long-edge binding)** or **Manual (Short-edge binding)** from **2-Sided Printing** on the **Main** tab.
5. Click **Settings**, make the appropriate settings, and then click **OK**.

**Note:**

To print as a booklet, select **Booklet**.

6. Set the other items on the **Main** and **More Options** tabs as necessary, and then click **OK**.
7. Click **Print**.

When the first side has finished printing, a pop-up window is displayed on the computer. Follow the on-screen instructions.

#### Related Information

- ➔ [“Available Paper and Capacities” on page 15](#)
- ➔ [“Loading Paper in the Rear Paper Feed” on page 16](#)
- ➔ [“Printing Basics - Windows” on page 21](#)



## Printing

### Printing Several Pages on One Sheet

You can print two or four pages of data on a single sheet of paper.

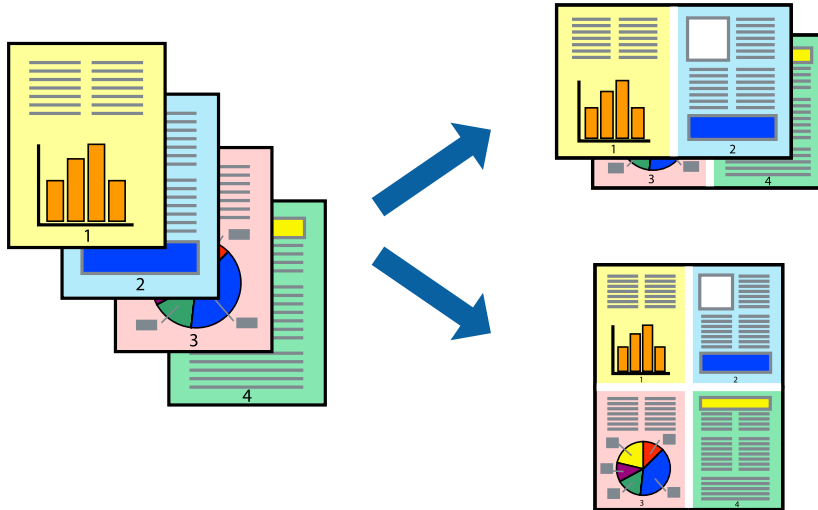

### Printing Several Pages on One Sheet - Windows

1. Load paper in the printer.
2. Open the file you want to print.
3. Access the printer driver window.
4. Select **2-Up** or **4-Up** as the **Multi-Page** setting on the **Main** tab.
5. Click **Page Order**, make the appropriate settings, and then click **OK** to close the window.
6. Set the other items on the **Main** and **More Options** tabs as necessary, and then click **OK**.
7. Click **Print**.

#### Related Information

- ➔ [“Loading Paper in the Rear Paper Feed” on page 16](#)
- ➔ [“Printing Basics - Windows” on page 21](#)

### Printing Several Pages on One Sheet - Mac OS X

1. Load paper in the printer.
2. Open the file you want to print.
3. Access the print dialog.
4. Select **Layout** from the pop-up menu.
5. Set the number of pages in **Pages per Sheet**, the **Layout Direction** (page order), and **Border**.

## Printing

6. Set the other items as necessary.
7. Click **Print**.

### Related Information

- ➔ [“Loading Paper in the Rear Paper Feed” on page 16](#)
- ➔ [“Printing Basics - Mac OS X” on page 22](#)

## Printing to Fit the Paper Size

You can print to fit the paper size you loaded in the printer.



## Printing to Fit the Paper Size - Windows

1. Load paper in the printer.
2. Open the file you want to print.
3. Access the printer driver window.
4. Make the following settings on the **More Options** tab.
  - Document Size: Select the paper size you set in the application.
  - Output Paper: Select the paper size you loaded in the printer.  
**Fit to Page** is selected automatically.

*Note:*  
*If you want to print a reduced image at the center of the page, select **Center**.*
5. Set the other items on the **Main** and **More Options** tabs as necessary, and then click **OK**.
6. Click **Print**.

### Related Information

- ➔ [“Loading Paper in the Rear Paper Feed” on page 16](#)
- ➔ [“Printing Basics - Windows” on page 21](#)

## Printing

### Printing to Fit the Paper Size - Mac OS X

1. Load paper in the printer.
2. Open the file you want to print.
3. Access the print dialog.
4. Select the size of the paper you set in the application as the **Paper Size** setting.
5. Select **Paper Handling** from the pop-up menu.
6. Select **Scale to fit paper size**.
7. Select the paper size you loaded in the printer as the **Destination Paper Size** setting.
8. Set the other items as necessary.
9. Click **Print**.

#### Related Information

- ➔ [“Loading Paper in the Rear Paper Feed” on page 16](#)
- ➔ [“Printing Basics - Mac OS X” on page 22](#)

### Printing Multiple Files Together (for Windows Only)

**Job Arranger Lite** allows you to combine several files created by different applications and print them as a single print job. You can specify the print settings for combined files, such as layout, print order, and orientation.

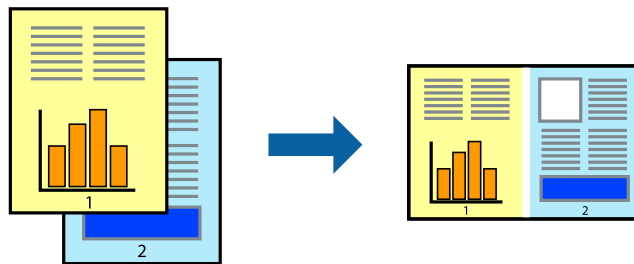

#### Note:

To open a **Print Project** saved in **Job Arranger Lite**, click **Job Arranger Lite** on the printer driver's **Maintenance** tab. Next, select **Open** from the **File** menu to select the file. The extension of the saved files is ".ecl".

1. Load paper in the printer.
2. Open the file you want to print.
3. Access the printer driver window.
4. Select **Job Arranger Lite** on the **Main** tab.
5. Click **OK** to close the printer driver window.

## Printing

- Click **Print**.

The **Job Arranger Lite** window is displayed and the print job is added to the **Print Project**.

- With the **Job Arranger Lite** window opened, open the file that you want to combine with the current file, and then repeat steps 3 to 6.

**Note:**

*If you close the **Job Arranger Lite** window, the unsaved **Print Project** is deleted. To print later, select **Save** from the **File** menu.*

- Select the **Layout** and **Edit** menus in **Job Arranger Lite** to edit the **Print Project** as necessary.
- Select **Print** from the **File** menu.

### Related Information

- ➔ [“Loading Paper in the Rear Paper Feed” on page 16](#)
- ➔ [“Printing Basics - Windows” on page 21](#)

## Enlarged Printing and Making Posters (for Windows Only)

You can print one image on multiple sheets of paper to create a larger poster. You can print alignment marks that help you stick the sheets together.

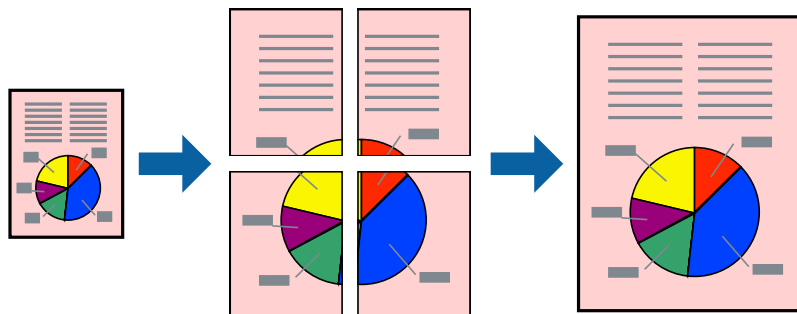

- Load paper in the printer.
- Open the file you want to print.
- Access the printer driver window.
- Select **2x1 Poster**, **2x2 Poster**, **3x3 Poster**, or **4x4 Poster** from **Multi-Page** on the **Main** tab.
- Click **Settings**, make the appropriate settings, and then click **OK**.
- Set the other items on the **Main** and **More Options** tabs as necessary, and then click **OK**.
- Click **Print**.

### Related Information

- ➔ [“Loading Paper in the Rear Paper Feed” on page 16](#)
- ➔ [“Printing Basics - Windows” on page 21](#)

## Printing

### Making Posters Using Overlapping Alignment Marks

Here is an example of how to make a poster when **2x2 Poster** is selected, and **Overlapping Alignment Marks** is selected in **Print Cutting Guides**.

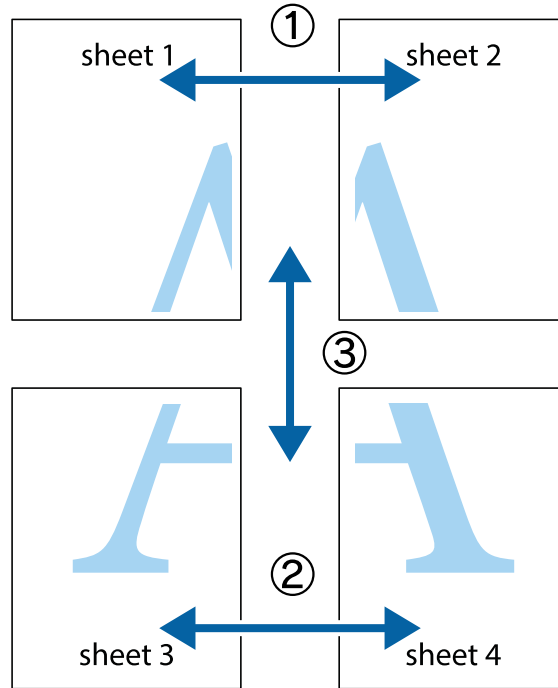

1. Prepare Sheet 1 and Sheet 2. Cut off the margins of Sheet 1 along the vertical blue line through the center of the top and bottom cross marks.

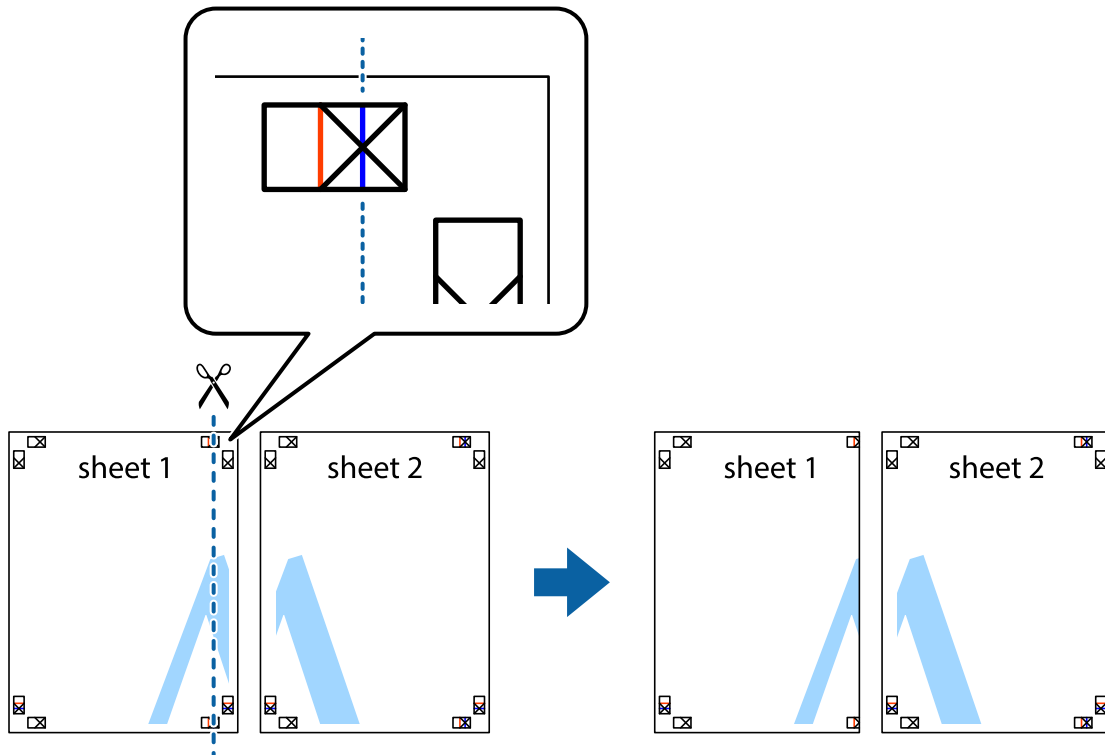

### Printing

2. Place the edge of Sheet 1 on top of Sheet 2 and align the cross marks, then temporarily tape the two sheets together from the back.

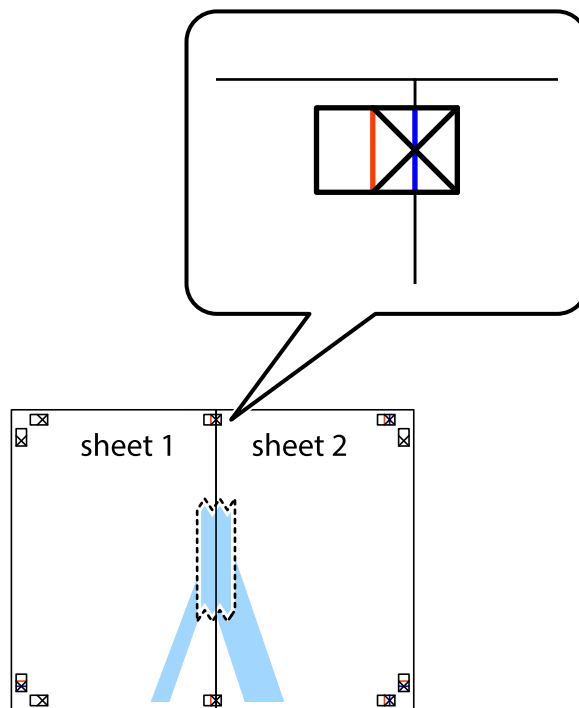

3. Cut the taped sheets in two along the vertical red line through the alignment markers (this time, the line to the left of the cross marks).

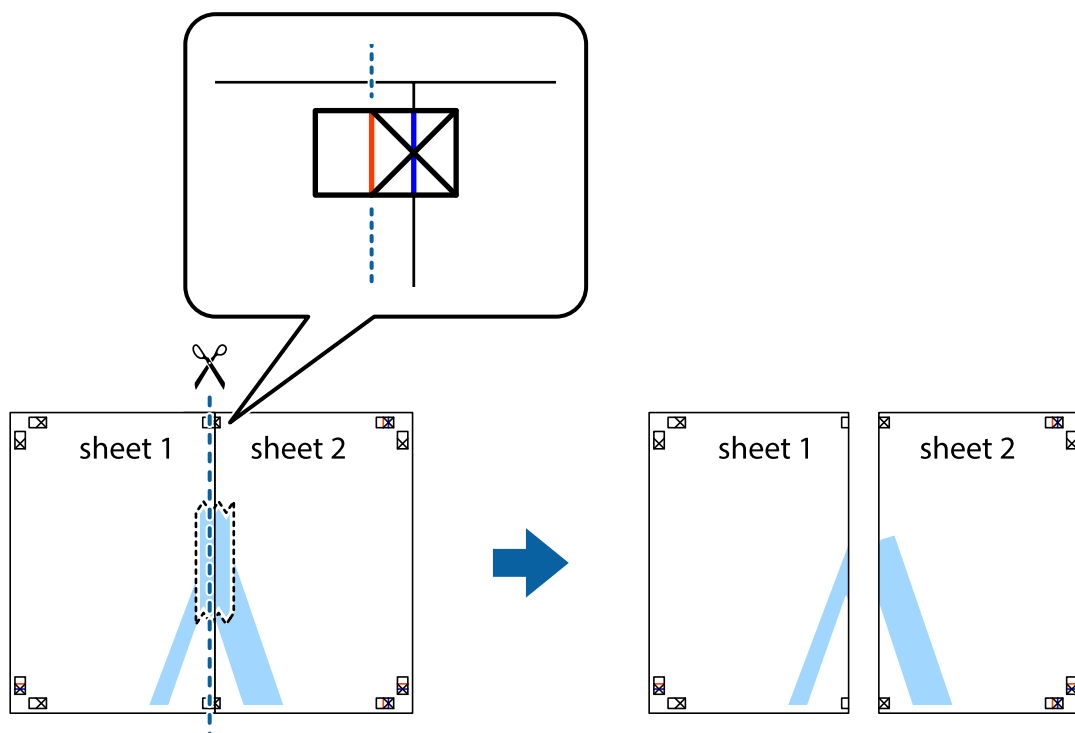

## Printing

4. Tape the sheets together from the back.

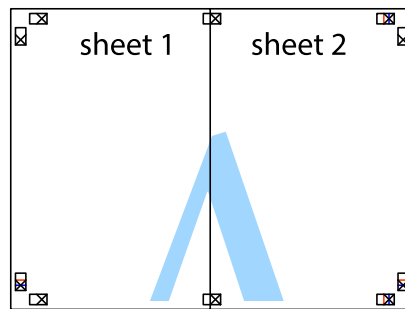

5. Repeat steps 1 to 4 to tape Sheet 3 and Sheet 4 together.
6. Cut off the margins of Sheet 1 and Sheet 2 along the horizontal blue line through the center of the left and right side cross marks.

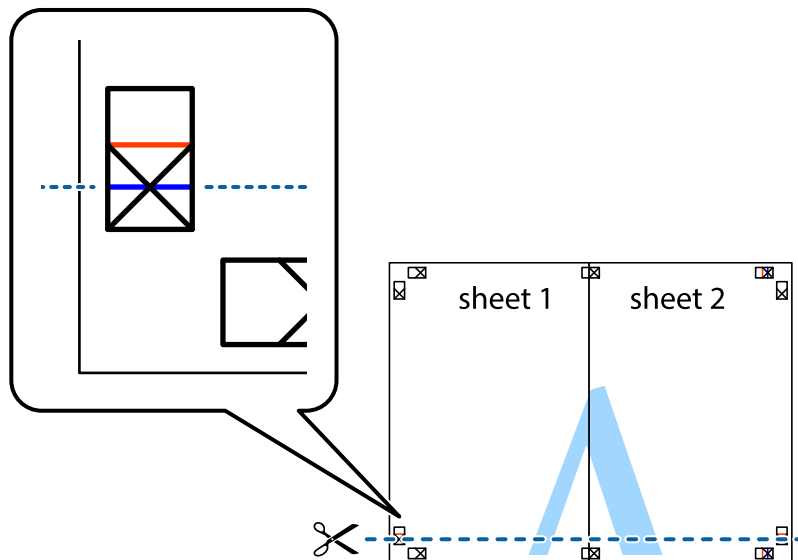

### Printing

7. Place the edge of Sheet 1 and Sheet 2 on top of Sheet 3 and Sheet 4 and align the cross marks, and then temporarily tape them together from the back.

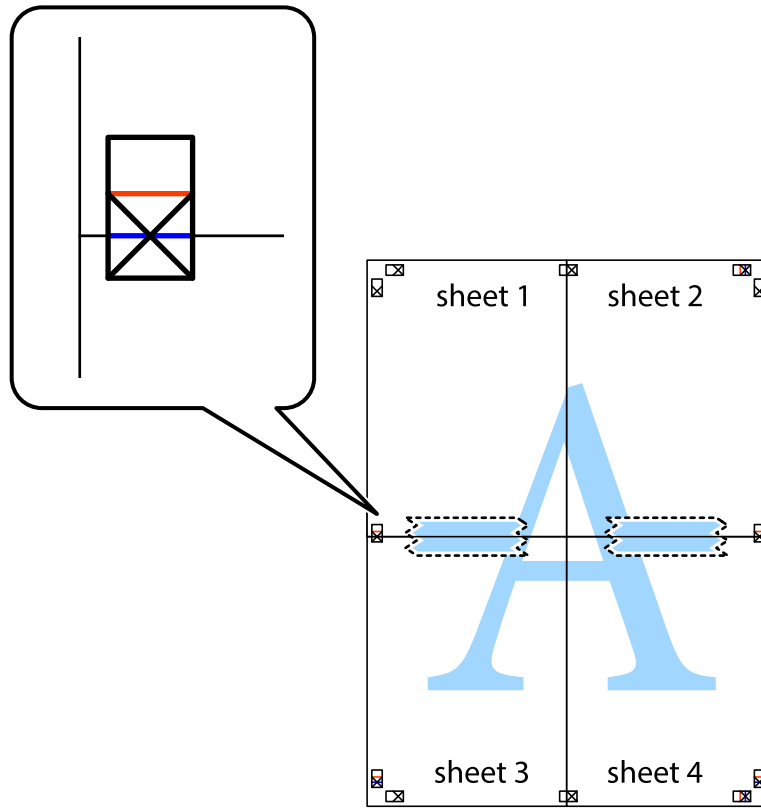



### Printing

- Cut the taped sheets in two along the horizontal red line through the alignment markers (this time, the line above the cross marks).

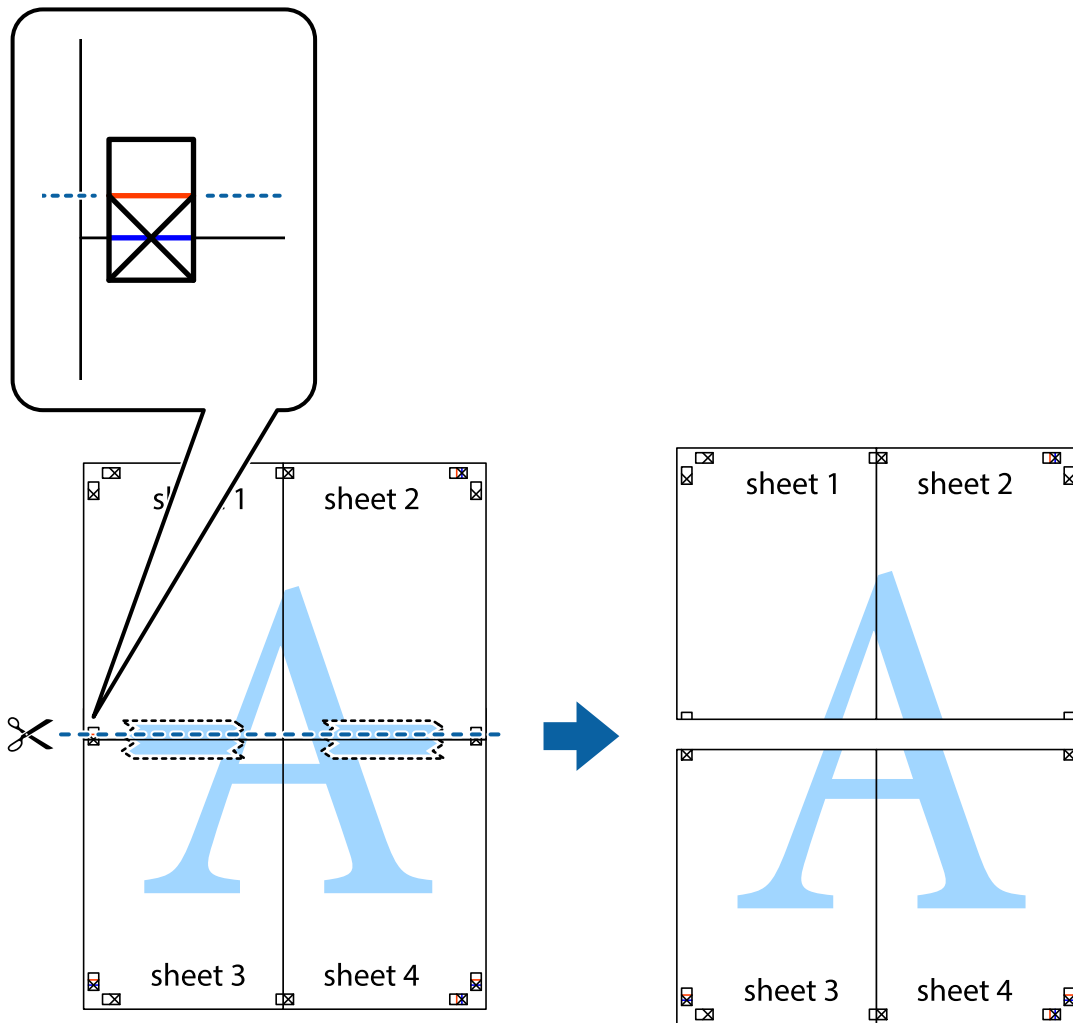

- Tape the sheets together from the back.

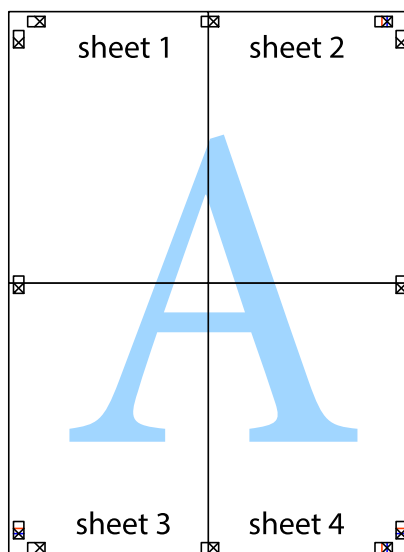

## Printing

10. Cut off the remaining margins along the outer guide.

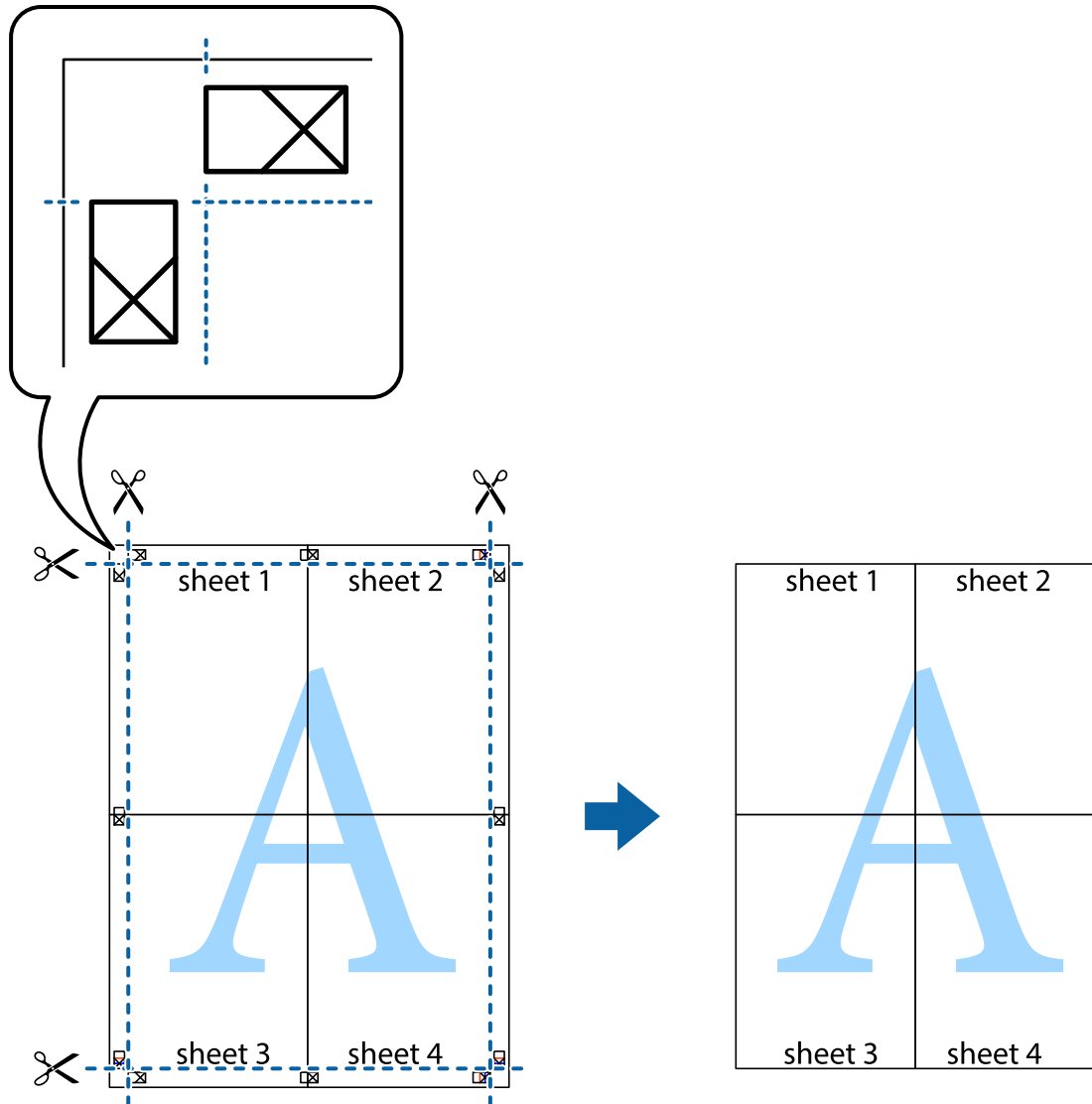

## Printing Using Advanced Features

This section introduces a variety of additional layout and printing features available on the printer driver.

### Related Information

- ➔ [“Windows Printer Driver” on page 55](#)
- ➔ [“Mac OS X Printer Driver” on page 58](#)

## Adding a Printing Preset to Print Easily

If you create your own preset of frequently used print settings on the printer driver, you can print easily by selecting the preset from the list.

## Printing

### Windows

To add your own preset, set items such as the **Document Size** and **Paper Type** on the **Main** or **More Options** tab, and then click **Add/Remove Presets** in **Printing Presets**.

**Note:**

To delete an added preset, click **Add/Remove Presets**, select the preset name you want to delete from the list, and then delete it.

### Mac OS X

Access the print dialog. To add your own preset, set items such as the **Paper Size** and **Media Type**, and then save the current settings as the preset in the **Presets** setting.

**Note:**

To delete an added preset, click **presets > Show Presets**, select the preset name you want to delete from the list, and then delete it.

## Printing a Reduced or Enlarged Document

You can reduce or enlarge the size of a document by a specific percentage.

### Windows

Set the **Document Size** on the **More Options** tab. Select **Reduce/Enlarge Document**, **Zoom to**, and then enter a percentage.

### Mac OS X

Select **Page Setup** from the **File** menu. Select the settings for **Format For** and **Paper Size**, and then enter a percentage in **Scale**. Close the window, and then print following the basic printing instructions.

## Adjusting the Print Color

You can adjust the colors used in the print job.

**PhotoEnhance** produces sharper images and more vivid colors by automatically adjusting the contrast, saturation, and brightness of the original image data.

**Note:**

These adjustments are not applied to the original data.

**PhotoEnhance** adjusts the color by analyzing the location of the subject. Therefore, if you have changed the location of the subject by reducing, enlarging, cropping, or rotating the image, the color may change unexpectedly. If the image is out of focus, the tone may be unnatural. If the color is changed or becomes unnatural, print in a mode other than **PhotoEnhance**.

### Windows

Select the method of color correction from **Color Correction** on the **More Options** tab.

If you select **Automatic**, the colors are automatically adjusted to match the paper type and print quality settings. If you select **Custom** and click **Advanced**, you can make your own settings.

### Mac OS X

Access the print dialog. Select **Color Matching** from the pop-up menu, and then select **EPSON Color Controls**. Select **Color Options** from the pop-up menu, and then select one of the available options. Click the arrow next to **Advanced Settings** and make the appropriate settings.

## Printing

### Printing a Watermark (for Windows Only)

You can print a watermark such as "Confidential" on your printouts. You can also add your own watermark.

Click **Watermark Features** on the **More Options** tab, and then select a watermark. Click **Settings** to change details such as the color and position of the watermark.

### Printing a Header and Footer (for Windows Only)

You can print information such as a user name and printing date as headers or footers.

Click **Watermark Features** in the **More Options** tab, and then select **Header/Footer**. Click **Settings** and select necessary items from the drop-down list.

### Printing Photos Using Epson Easy Photo Print

Epson Easy Photo Print lets you lay out and print photos easily on various types of paper.

**Note:**

*By printing on genuine Epson photo paper, the ink quality is maximized and the printouts are vivid and clear.*

#### Related Information

- ➔ [“Available Paper and Capacities” on page 15](#)
- ➔ [“Loading Paper in the Rear Paper Feed” on page 16](#)
- ➔ [“Epson Easy Photo Print” on page 62](#)

---

## Canceling Printing

**Note:**

- In Windows, you cannot cancel a print job from the computer once it has been completely sent to the printer. In this case, cancel the print job by using the printer's control panel.*
- When printing several pages from Mac OS X, you cannot cancel all of the jobs by using the control panel. In this case, cancel the print job from the computer.*

### Canceling Printing - Printer Button

Press the  button to cancel the print job in progress.

### Canceling Printing - Windows

1. Access the printer driver window.
2. Select the **Maintenance** tab.
3. Click **Print Queue**.
4. Right-click on the job you want to cancel and then select **Cancel**.

**Related Information**

➔ [“Windows Printer Driver” on page 55](#)

## Canceling Printing - Mac OS X



1. Click the printer icon in the **Dock**.
2. Select the job you want to cancel.
3. Cancel the job.
  - Mac OS X v10.8.x to Mac OS X v10.9.x  
Click  next to the progress meter.
  - Mac OS X v10.6.8 to v10.7.x  
Click **Delete**.

# Copying

---

## Copying Basics

You can copy on A4-size paper at the same magnification. Margins with a width of 3 mm appear around the edges of the paper regardless of whether or not the original has margins around the edges of the paper. When copying originals smaller than A4-size, margins will be wider than 3 mm depending on the position where you place the original.

1. Load A4-size paper in the printer.
2. Place the originals.
3. Press the  or  button.

**Note:**

Hold down the  or  button while pressing the  button to copy in draft mode, where you can use less ink and print at a lower density.



### Related Information

- ➔ [“Loading Paper in the Rear Paper Feed” on page 16](#)
- ➔ [“Placing Originals on the Scanner Glass” on page 19](#)

---

## Making Multiple Copies

You can make multiple copies at a time. You can specify up to 20 copies. Margins with a width of 3 mm appear around the edges of the paper.

1. Load the same number of sheets of A4-size paper as the number of copies you want to copy.
2. Place the originals.
3. Press the  or  button the same number of times as the number of copies you want to make. For example, if you want to make 10 copies in color, press the  button 10 times.

**Note:**

Press the button within one second to change the number of copies. If the button is pressed after one second, the number of copies is set and copying starts.

### Related Information

- ➔ [“Loading Paper in the Rear Paper Feed” on page 16](#)
- ➔ [“Placing Originals on the Scanner Glass” on page 19](#)

# Scanning



---

## Scanning from the Control Panel

You can save the scanned image in PDF format to a computer which is connected to the printer with a USB cable.

**Important:**

*Make sure you have installed EPSON Scan and Epson Event Manager on your computer before using this feature.*

1. Place the originals.
2. Press the  button and the  button simultaneously.

**Note:**

*You can change to frequently-used scan settings such as the document type, folder to save, or save format by using Epson Event Manager.*

**Related Information**

- ➔ [“Placing Originals on the Scanner Glass” on page 19](#)
- ➔ [“Epson Event Manager” on page 61](#)

---

## Scanning from a Computer

Scan using the scanner driver "EPSON Scan". See the EPSON Scan help for an explanation of each setting item.

### Scanning Basics

This section uses EPSON Scan's **Home Mode** to explain the basics of scanning. The operation work flow is the same in other scanning modes.

1. Place the originals.
2. Start EPSON Scan.

## Scanning

3. Select **Home Mode** from the **Mode** list.

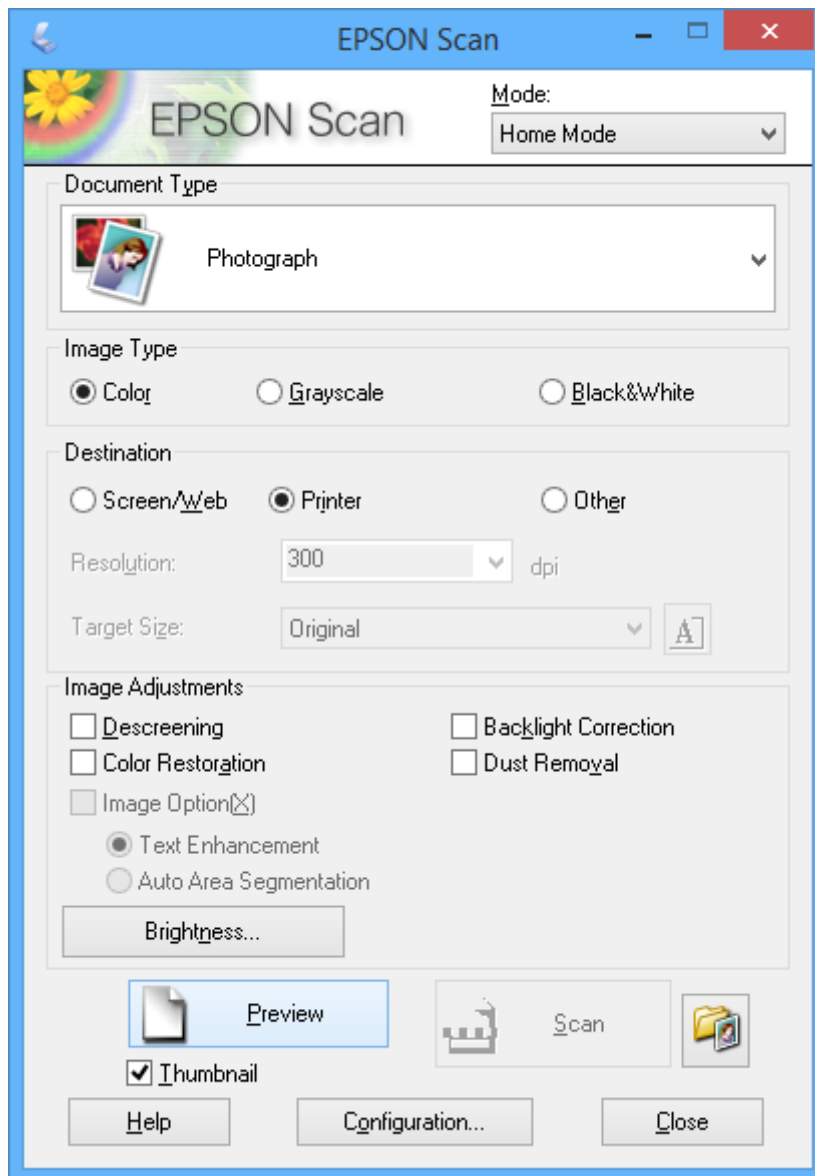

4. Make the following settings.
  - Document Type: Select the type of the original you want to scan.
  - Image Type: Select the color type of the image you want to scan.  
Although this is automatically selected by the **Document Type** setting, you can change the setting.
  - Destination: Select the resolution of the image you want to scan.  
If you select **Other**, you can set **Resolution**.
  - Thumbnail: Only available if you select **Photograph** as the Document Type setting.  
If you select this item and click **Preview**, you can scan by automatically detecting the scan area, direction, or skew of the document, or place multiple photos on the scanner glass.



## Scanning

5. Click **Preview**.

**Note:**

- ❑ *Depending on the photos and the scanning conditions, the scan results may not be as intended. Clear **Thumbnail**, and only place one photo.*
- ❑ *When placing multiple photos, place them at least 20 mm (0.8 inch) apart. Also, the edge area of the scanner glass is not scanned.*

6. Adjust the quality or brightness of the image as necessary.

**Note:**

*Depending on the originals, the scan results may not be as intended.*

7. Click **Scan**.

8. In the **File Save Settings** window, make appropriate settings and then click **OK**.

**Note:**

*When **Show this dialog box before next scan** is cleared, the **File Save Settings** screen is not displayed and scanning starts immediately. To display the **File Save Settings** screen, click the icon (**File Save Settings**) to the right of **Scan** before starting to scan.*

### Related Information

- ➔ [“Placing Originals on the Scanner Glass” on page 19](#)
- ➔ [“EPSON Scan \(Scanner Driver\)” on page 61](#)

## Scanning

## Scanning Using Advanced Features

## Scanning by Detecting the Original Automatically (Full Auto Mode)

You can start scanning by simply placing the original and clicking **Scan**. Select **Full Auto Mode** from the **Mode** list in EPSON Scan.

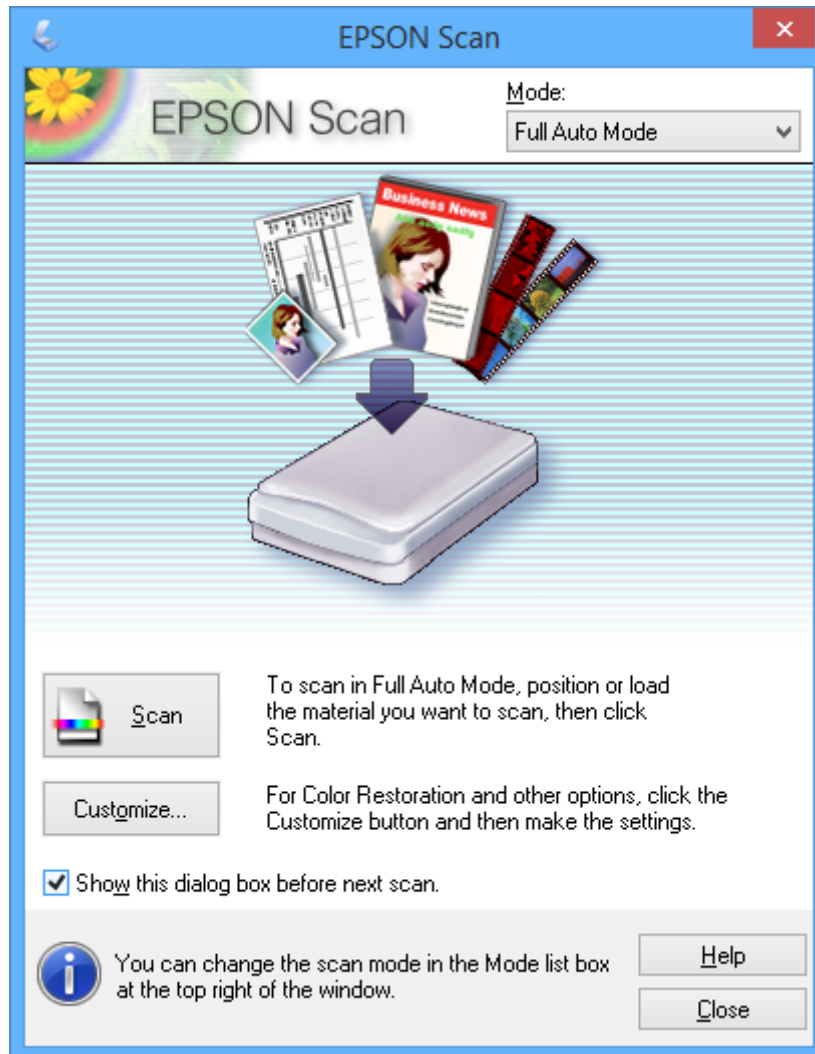

## Scanning

### Scanning at Specified Sizes (Office Mode)

You can scan originals at the specified size without previewing the image. Select **Office Mode** from the **Mode** list in EPSON Scan.

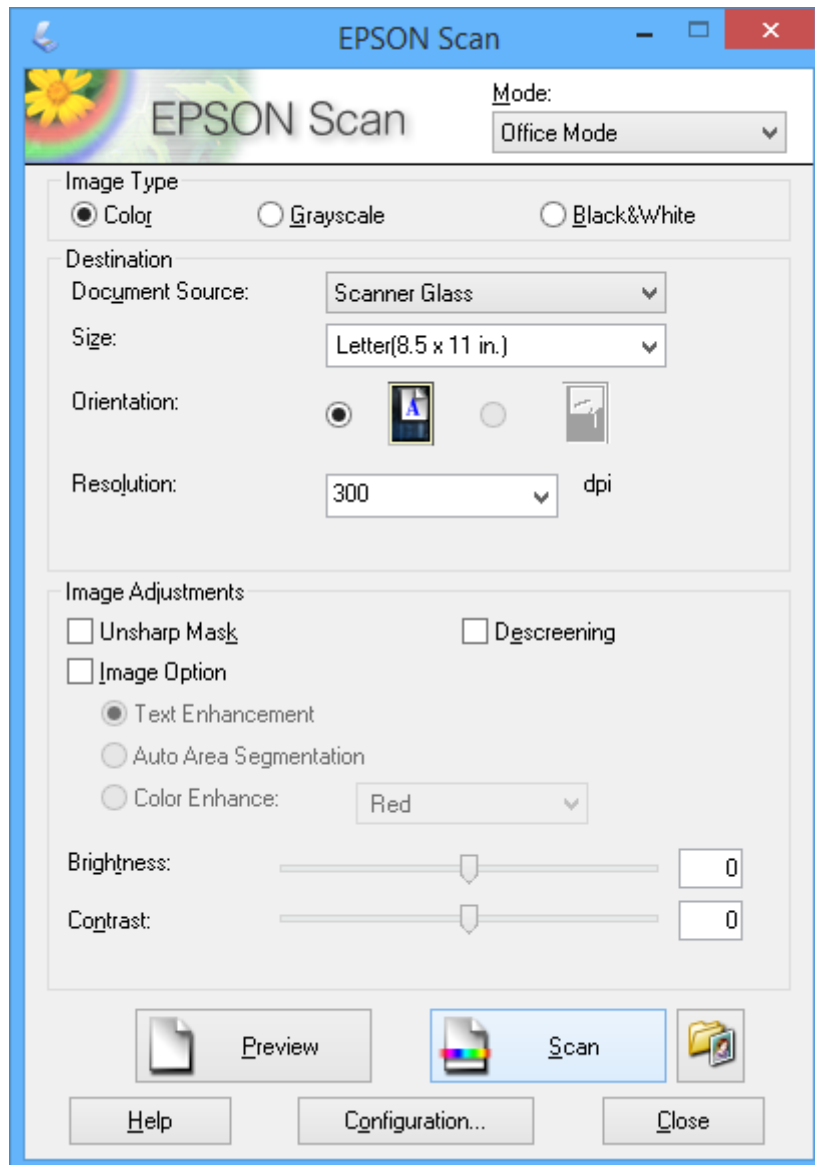

## Scanning

**Scanning by Adjusting the Image Quality (Professional Mode)**

You can scan images while adjusting the quality and color. This mode is recommended for advanced users. Select **Professional Mode** from the **Mode** list in EPSON Scan.

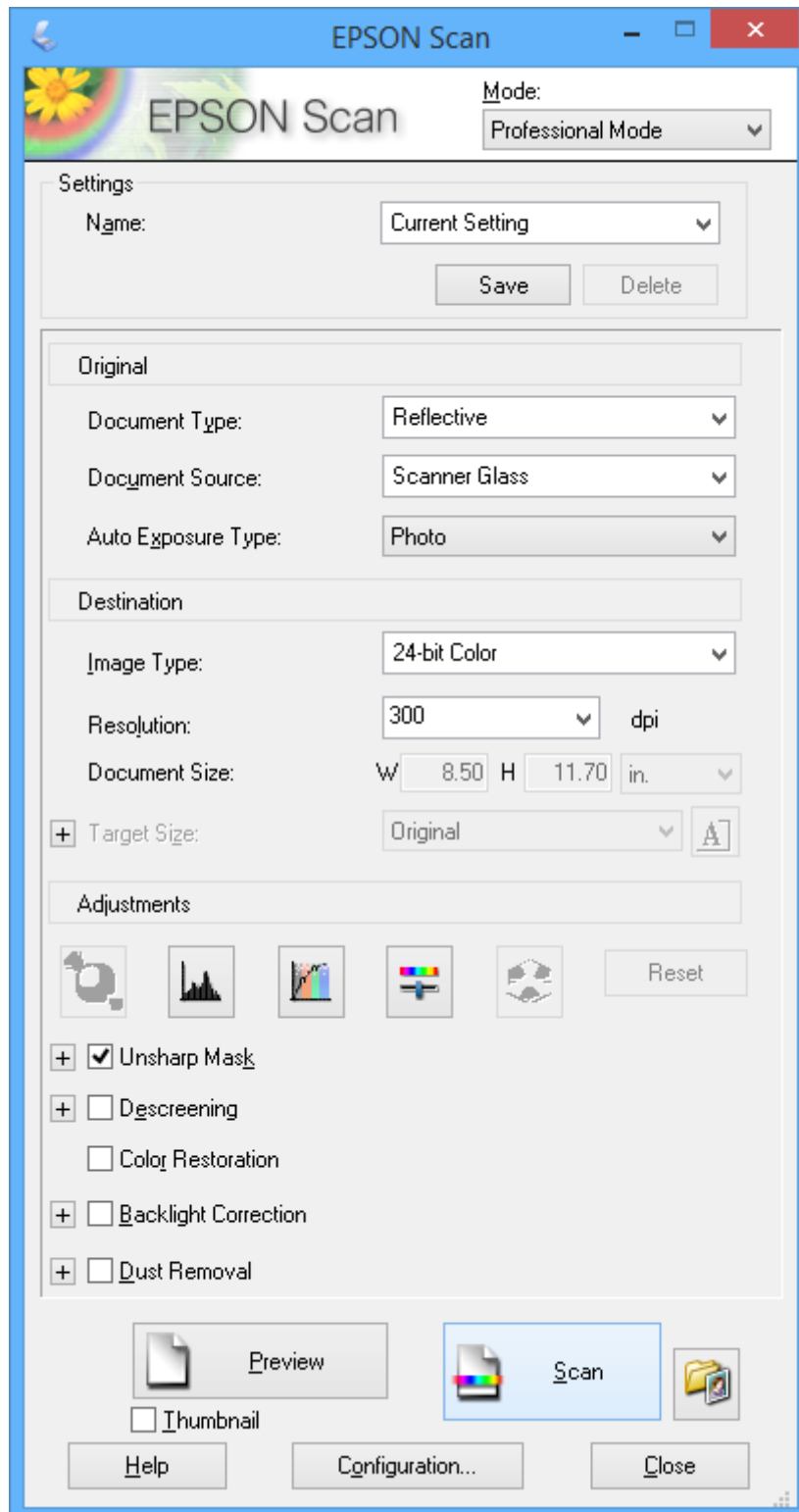

# Refilling Ink

## Checking the Ink Levels - Tank

To confirm the actual ink remaining, visually check the ink levels in all of the printer's tanks.

**!** *Important:*

*If any of the ink tanks are not filled up to the lower line, fill them to the upper line on the ink tank. Continued use of the printer when the ink level is below the lower line on the tanks could damage the printer.*

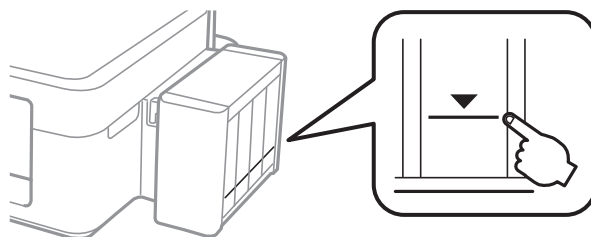

## Ink Bottle Codes

Epson recommends the use of genuine Epson ink bottles. Epson cannot guarantee the quality or reliability of non-genuine ink. The use of non-genuine ink may cause damage that is not covered by Epson's warranties, and under certain circumstances, may cause erratic printer behavior.

Other products not manufactured by Epson may cause damage that is not covered by Epson's warranties, and under certain circumstances, may cause erratic printer behavior.

The following are the codes for genuine Epson ink bottles.

BK (Black)	C (Cyan)	M (Magenta)	Y (Yellow)
664	664	664	664

**!** *Important:*

*Use of genuine Epson ink other than specified could cause damage that is not covered by Epson's warranties.*

**Note:**

For European users, visit the following website for information on Epson's ink bottle yields.

<http://www.epson.eu/pageyield>

## Ink Bottle Handling Precautions

Read the following instructions before refilling ink.

## Refilling Ink

### Handling precautions

- ❑ Use ink bottles with the correct part code for this printer.
- ❑ This printer requires careful handling of ink. Ink may splatter when the ink tanks are filled or refilled with ink. If ink gets on your clothes or belongings, it may not come off.
- ❑ Store ink bottles at normal room temperature and keep them away from direct sunlight.
- ❑ Epson recommends using the ink bottle before the date printed on the package.
- ❑ Store the ink bottles in the same environment as the printer.
- ❑ When storing or transporting an ink bottle after removing its seal, do not tilt the bottle and do not subject it to impacts or temperature changes. Otherwise, ink may leak even if the cap on the ink bottle is tightened securely. Be sure to keep the ink bottle upright when tightening the cap, and take measures to prevent ink from leaking when you transport the bottle.
- ❑ After bringing an ink bottle inside from a cold storage site, allow it to warm up at room temperature for at least three hours before using it.
- ❑ Do not open the ink bottle package until you are ready to fill the ink tank. The ink bottle is vacuum packed to maintain its reliability. If you leave an ink bottle unpacked for a long time before using it, normal printing may not be possible.
- ❑ If any of the ink tanks are not filled up to the lower line, refill the ink soon. Continued use of the printer when the ink level is below the lower line on the tanks could damage the printer.
- ❑ Although the ink bottles may contain recycled materials, this does not affect printer function or performance.
- ❑ Specifications and appearance of the ink bottle are subject to change without prior notice for improvement.
- ❑ Quoted yields may vary depending on the images that you are printing, the paper type that you are using, the frequency of your prints and environmental conditions such as temperature.

### Ink consumption

- ❑ To maintain optimum print head performance, some ink is consumed from all ink tanks not only during printing but also during maintenance operation such as print head cleaning.
- ❑ When printing in monochrome or grayscale, color inks instead of black ink may be used depending on the paper type or print quality settings. This is because a mixture of color inks is used to create black.
- ❑ The ink in the ink bottles supplied with your printer is partly used during initial setup. In order to produce high quality printouts, the print head in your printer will be fully charged with ink. This one-off process consumes a quantity of ink and therefore these bottles may print fewer pages compared to subsequent ink bottles.

---

## Refilling the Ink Tanks

Ink can be refilled at any time.

1. Unhook the ink tank unit from the printer and lay it down.

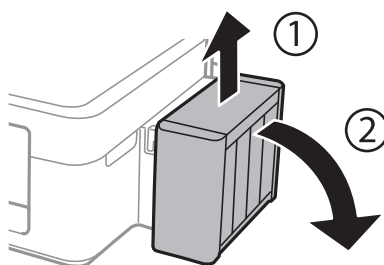

## Refilling Ink

**!** *Important:*

*Do not pull the tubes.*

2. Open the ink tank unit cover, and then remove the cap of the ink tank.

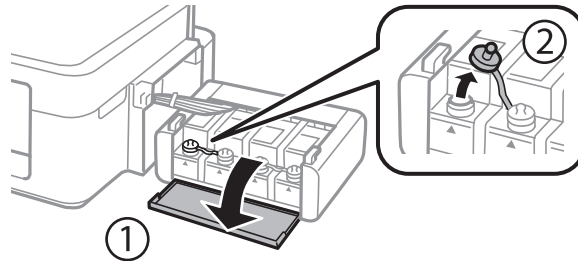

**!** *Important:*

- Be careful not to spill any ink.*
- Make sure that the color of the ink tank matches the ink color that you want to refill.*

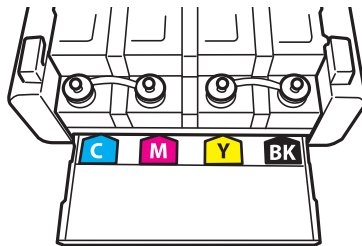

3. Snap off the top of the cap, remove the cap of the ink bottle, remove the seal from the bottle, and then install the cap.

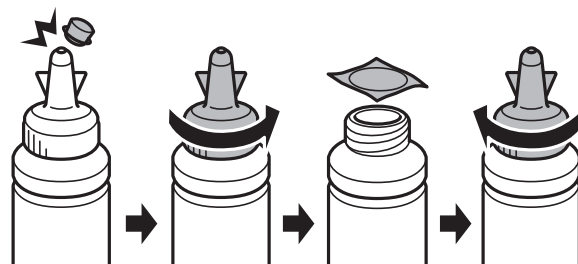

## Refilling Ink

**!** *Important:*

*Close the ink bottle cap tightly; otherwise ink may leak.*

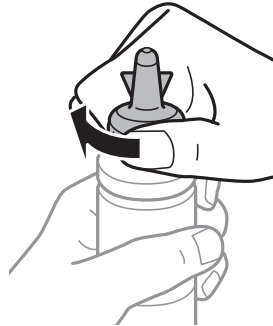

**Note:**

*Do not dispose of the top of the cap. If any ink remains in the ink bottle after refilling the tank, use the top of the cap to seal the ink bottle cap.*

4. Refill the ink tank with the correct colored ink up to the upper line on the ink tank.

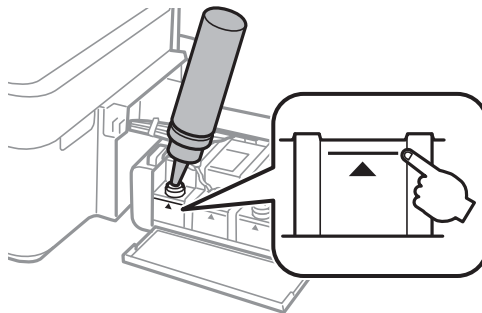

**Note:**

*If any ink remains in the ink bottle after filling the ink tank up to the upper line, install the cap securely and store the ink bottle upright for later use.*

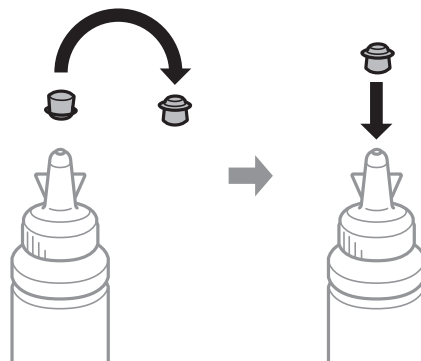



## Refilling Ink

5. Close the cap onto the ink tank securely.

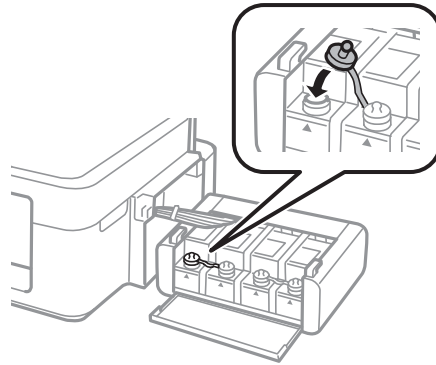

6. Close the ink tank unit cover.

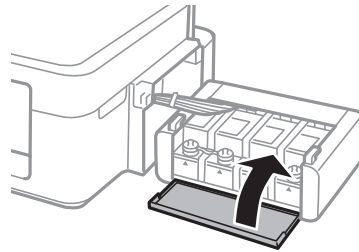

7. Hook the ink tank unit onto the printer.

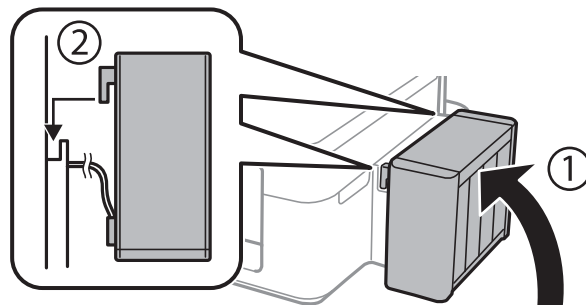

### Related Information

- ➔ [“Ink Bottle Codes” on page 45](#)
- ➔ [“Ink Bottle Handling Precautions” on page 45](#)

# Improving Print and Scan Quality

## Checking and Cleaning the Print Head

If the nozzles are clogged, the printouts become faint, there is visible banding, or unexpected colors appear. When print quality has declined, use the nozzle check feature and check if the nozzles are clogged. If the nozzles are clogged, clean the print head.



**!** **Important:**

*Do not open the scanner unit or turn off the printer during head cleaning. If the head cleaning is incomplete, you may not be able to print.*

**Note:**

- Because print head cleaning uses some ink, clean the print head only if quality declines.
- When ink is low, you may not be able to clean the print head. Prepare a new ink bottle.
- If print quality has not improved after repeating nozzle check and head cleaning three times, wait for at least 12 hours without printing, and then run the nozzle check again and repeat the head cleaning if necessary. We recommend to turn off the printer. If print quality has still not improved, contact Epson support.
- To prevent the print head from drying out, do not unplug the printer while the power is on.
- To keep the print head operating at its best, we recommend printing a few pages on a regular basis.

## Checking and Cleaning the Print Head - Printer Buttons

1. Load A4-size plain paper in the printer.
2. Press the  button to turn off the printer.
3. Turn the printer on while holding the  button down, and then release the buttons when the power light flashes.

The nozzle check pattern is printed.

4. Compare the printed check pattern with the sample shown below.
  - All lines are printed: The print head nozzles are not clogged. You do not need to clean the print head.

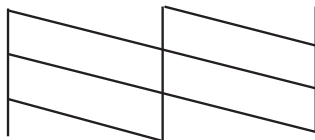

## Improving Print and Scan Quality

- ❑ There are broken lines or missing segments: The print head nozzles may be clogged. Go to the next step.

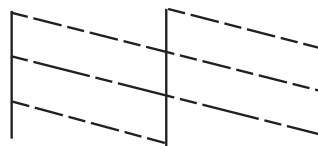

**Note:**

*The test pattern may vary by model.*

5. Hold the Ⓞ button down for three seconds until the power light starts flashing.  
Print head cleaning starts.
6. When the power light stops flashing, print a nozzle check pattern again. Repeat cleaning and printing the pattern until all lines are printed completely.

### Related Information

- ➔ [“Loading Paper in the Rear Paper Feed” on page 16](#)

## Checking and Cleaning the Print Head - Windows

1. Load A4-size plain paper in the printer.
2. Access the printer driver window.
3. Click **Nozzle Check** on the **Maintenance** tab.
4. Follow the on-screen instructions.

### Related Information

- ➔ [“Loading Paper in the Rear Paper Feed” on page 16](#)
- ➔ [“Windows Printer Driver” on page 55](#)

## Checking and Cleaning the Print Head - Mac OS X

1. Load A4-size plain paper in the printer.
2. Select **System Preferences** from the  menu > **Printers & Scanners** (or **Print & Scan, Print & Fax**), and then select the printer.
3. Click **Options & Supplies** > **Utility** > **Open Printer Utility**.
4. Click **Nozzle Check**.
5. Follow the on-screen instructions.

**Related Information**

➔ [“Loading Paper in the Rear Paper Feed” on page 16](#)

---

## Replacing Ink inside the Ink Tubes

If you have not used the printer for a long time and notice banding or missing colors in the printouts, you may need to replace the ink inside the ink tubes to solve the problem. The **Power Ink Flushing** utility allows you to replace all of the ink inside the ink tubes.

 **Important:**

*This feature consumes a lot of ink. Before using this feature, make sure there is enough ink in the printer's ink tanks. If there is not enough ink, refill the ink tanks.*

 **Caution:**

- ❑ *This feature effects the service life of the ink pad. Ink pad reaches its capacity earlier by running this feature. Contact Epson or an authorised Epson service provider to request replacement before the end of its service life. It is not a user-serviceable part.*
- ❑ *After using the Power Ink Flushing utility, turn the printer off and wait for at least 12 hours. Using this feature improves the print quality after 12 hours, however it cannot be used again within 12 hours of the last use. If you still cannot solve the problem after trying all of the methods above, contact Epson support.*

## Replacing Ink inside the Ink Tubes - Windows

1. Access the printer driver window.
2. Click **Power Ink Flushing** on the **Maintenance** tab.
3. Follow the on-screen instructions.

**Related Information**

➔ [“Windows Printer Driver” on page 55](#)

## Replacing Ink inside the Ink Tubes - Mac OS X

1. Select **System Preferences** from the  menu > **Printers & Scanners** (or **Print & Scan, Print & Fax**), and then select the printer.
2. Click **Options & Supplies** > **Utility** > **Open Printer Utility**.
3. Click **Power Ink Flushing**.
4. Follow the on-screen instructions.

---

## Aligning the Print Head

If you notice a misalignment of vertical lines or blurred images, align the print head.

### Aligning the Print Head - Windows

1. Load A4-size plain paper in the printer.
2. Access the printer driver window.
3. Click **Print Head Alignment** on the **Maintenance** tab.
4. Follow the on-screen instructions.

#### Related Information

- ➔ [“Loading Paper in the Rear Paper Feed” on page 16](#)
- ➔ [“Windows Printer Driver” on page 55](#)

### Aligning the Print Head - Mac OS X

1. Load A4-size plain paper in the printer.
2. Select **System Preferences** from the  menu > **Printers & Scanners** (or **Print & Scan**, **Print & Fax**), and then select the printer.
3. Click **Options & Supplies** > **Utility** > **Open Printer Utility**.
4. Click **Print Head Alignment**.
5. Follow the on-screen instructions.

#### Related Information

- ➔ [“Loading Paper in the Rear Paper Feed” on page 16](#)

---

## Cleaning the Paper Path

When the printouts are smeared or scuffed, clean the roller inside.

**Important:**

*Do not use tissue paper to clean the inside of the printer. The print head nozzles may be clogged with lint.*

1. Make sure there is no dust or stains on the scanner glass.
2. Load A4-size plain paper in the printer.

## Improving Print and Scan Quality

3. Start copying without placing the original.

**Note:**

*Repeat this procedure until the paper is not smeared with ink.*

### Related Information

- ➔ [“Loading Paper in the Rear Paper Feed” on page 16](#)
- ➔ [“Copying Basics” on page 38](#)

---

## Cleaning the Scanner Glass

When the copies or scanned images are smeared or scuffed, clean the scanner glass.



**Important:**

*Never use alcohol or thinner to clean the printer. These chemicals can damage the printer.*

1. Open the document cover.

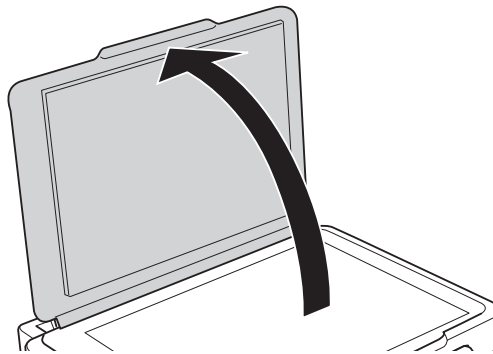

2. Use a soft, dry, clean cloth to clean the surface of the scanner glass.

**Note:**

- If the glass surface is stained with grease or some other hard-to-remove material, use a small amount of glass cleaner and a soft cloth to remove it. Wipe off all remaining liquid.*
- Do not press the glass surface too hard.*
- Be careful not to scratch or damage the surface of the glass. A damaged glass surface can decrease the scan quality.*

# Application Information

---

## Necessary Applications

### Windows Printer Driver

The printer driver is an application that controls the printer according to the print commands from other applications. Making settings on the printer driver provides the best printing results. You can also check the status of the printer or keep it in top operating condition using the printer driver utility.

**Note:**

*You can change the language of the printer driver. Select the language you want to use from the **Language** setting on the **Maintenance** tab.*

#### Accessing the printer driver from applications

To make settings that apply only to the application you are using, access from that application.

Select **Print** or **Print Setup** from the **File** menu. Select your printer, and then click **Preferences** or **Properties**.

**Note:**

*Operations differ depending on the application. See the application's help for details.*

#### Accessing the printer driver from the control panel

To make settings that apply to all of the applications, access from the control panel.

Windows 8.1/Windows 8

Select **Desktop > Settings > Control Panel > View devices and printers** in **Hardware and Sound**. Right-click on your printer, or press and hold it and then select **Printing preferences**.

Windows 7

Click the start button, and select **Control Panel > View devices and printers** in **Hardware and Sound**. Right-click on your printer and select **Printing preferences**.

Windows Vista

Click the start button, and select **Control Panel > Printers** in **Hardware and Sound**. Right-click on your printer and select **Printing preferences**.

Windows XP

Click the start button, and select **Control Panel > Printers and Other Hardware > Printers and Faxes**. Right-click on your printer and select **Printing preferences**.

#### Accessing the printer driver from the printer icon on the task bar

The printer icon on the desktop task bar is a shortcut icon allowing you to quickly access the printer driver.

If you click the printer icon and select **Printer Settings**, you can access the same printer settings window as the one displayed from the control panel. If you double-click this icon, you can check the status of the printer.

**Note:**

*If the printer icon is not displayed on the task bar, access the printer driver window, click **Monitoring Preferences** on the **Maintenance** tab, and then select **Register the shortcut icon to the taskbar**.*

## Application Information

### Guide to Windows Printer Driver

Help is available in the printer driver for Windows. To view explanations of the setting items, right-click on each item, and then click **Help**.

#### Main Tab

You can make basic settings for printing, such as paper type or paper size.

You can also make settings for printing both sides of the paper or printing multiple pages on one sheet.

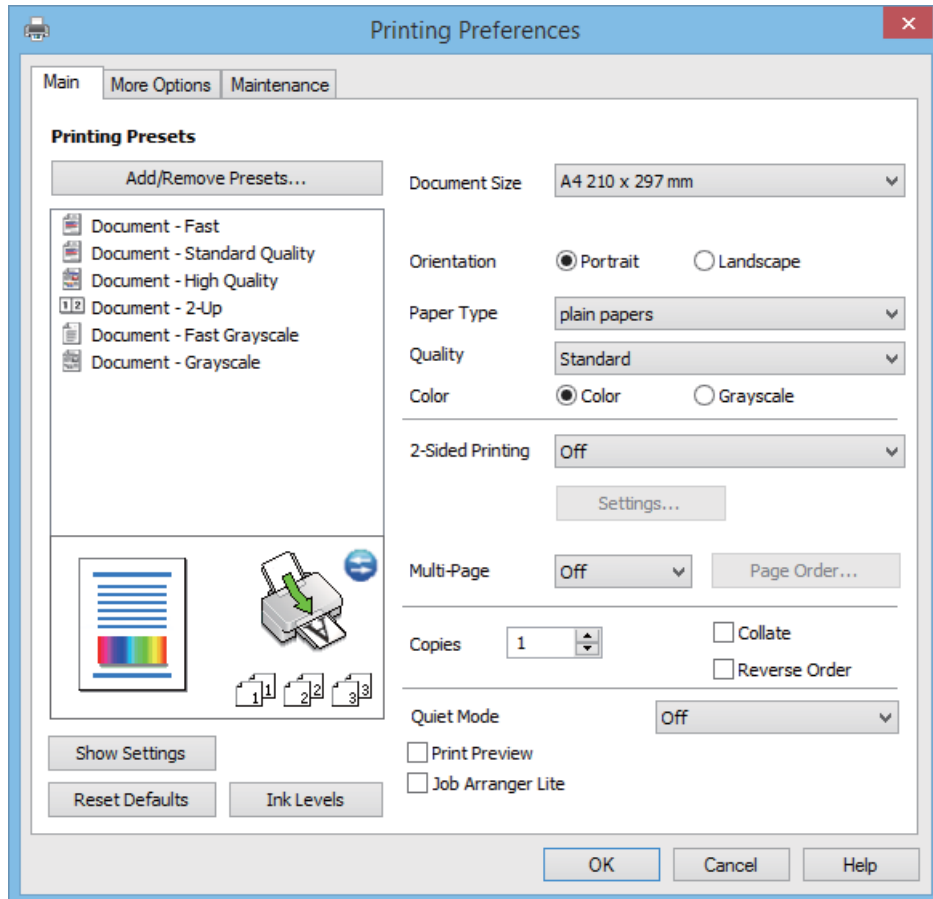



## Application Information

### More Options Tab

You can select additional layout and printing options such as changing the size of a printout or making color corrections.

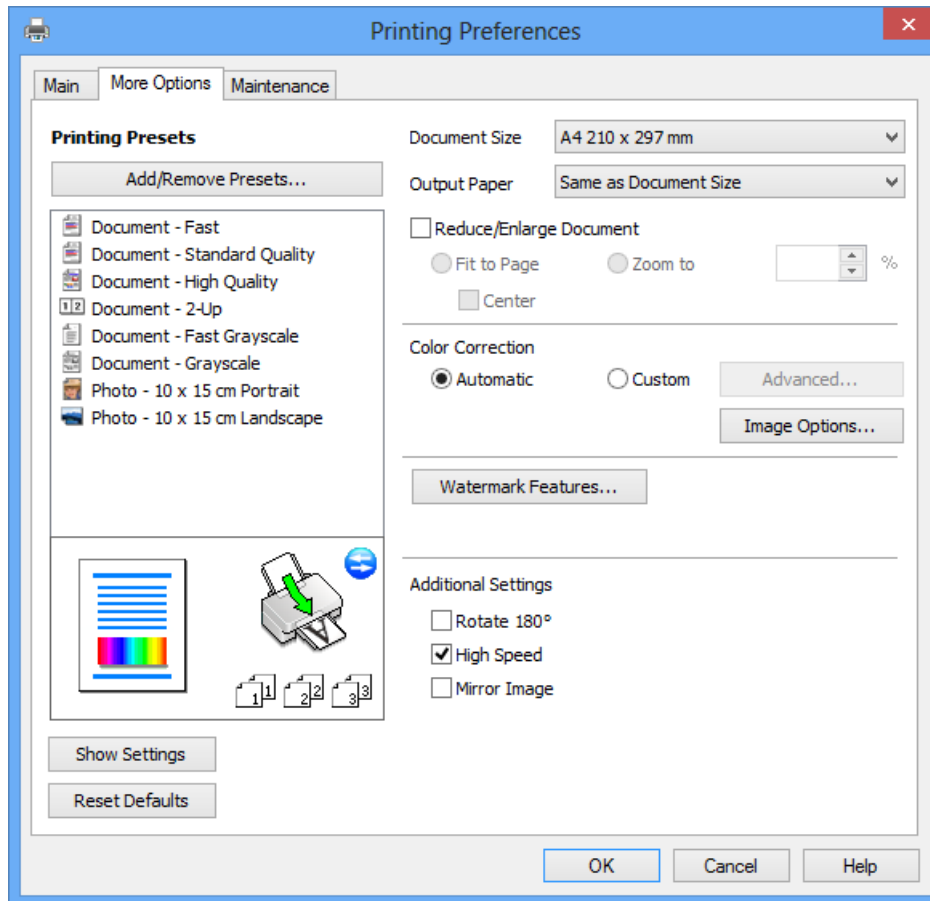

## Application Information

### Maintenance Tab

You can run maintenance features such as nozzle check and print head cleaning, and by starting **EPSON Status Monitor 3**, you can check printer status and error information.

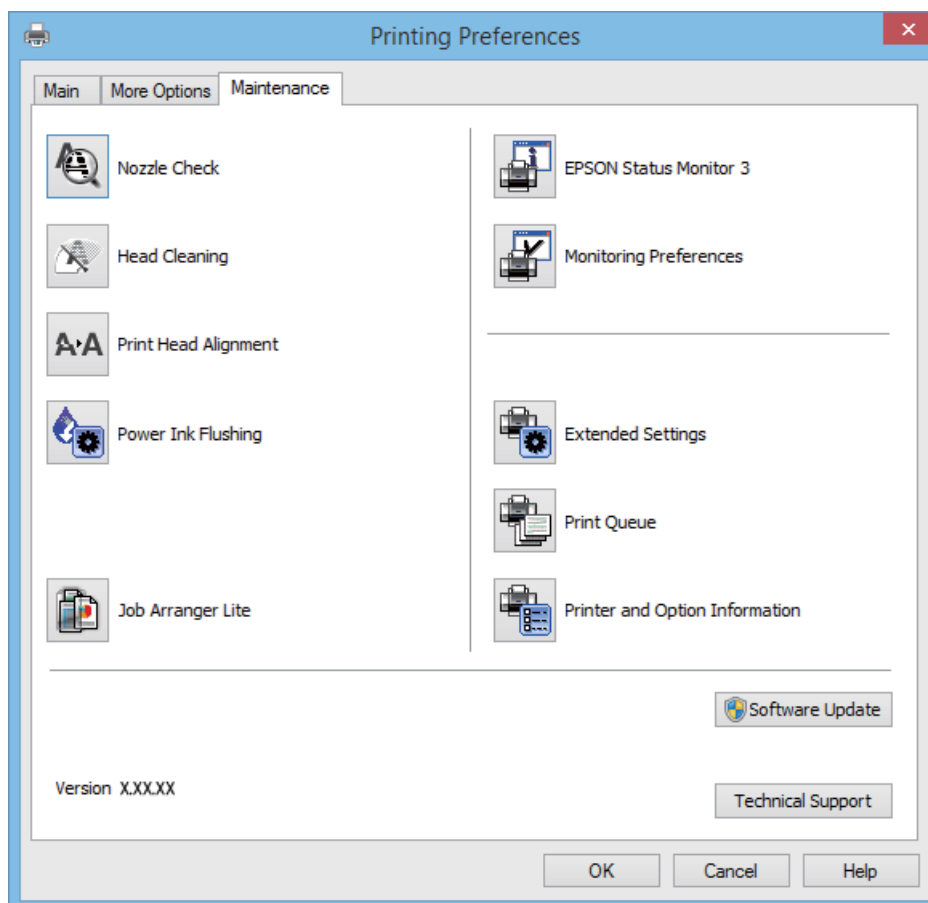

### Making Operation Settings for the Windows Printer Driver

You can make settings such as enabling **EPSON Status Monitor 3**.

1. Access the printer driver window.
2. Click **Extended Settings** on the **Maintenance** tab.
3. Make the appropriate settings, and then click **OK**.  
See the online help for explanations of the setting items.

### Related Information

➔ [“Windows Printer Driver” on page 55](#)

### Mac OS X Printer Driver

The printer driver is an application that controls the printer according to the print commands from other applications. Making settings on the printer driver provides the best printing results. You can also check the status of the printer or keep it in top operating condition using the printer driver utility.

## Application Information

### Accessing the printer driver from applications

Select **Print** from the **File** menu. If necessary, click **Show Details** (or ▼) to expand the print window.

**Note:**

Operations differ depending on the application. See the application's help for details.

### Starting the utility

Select **System Preferences** from the  menu > **Printers & Scanners** (or **Print & Scan, Print & Fax**), and then select the printer. Click **Options & Supplies** > **Utility** > **Open Printer Utility**.

## Guide to Mac OS X Printer Driver

### Print dialog

Switch the pop-up menu on the center of the screen to show more items.

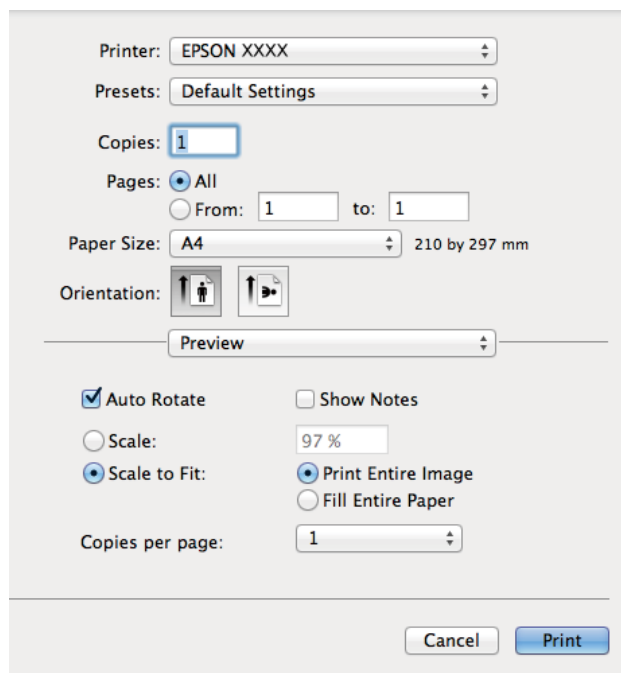

Pop-up Menu	Descriptions
Print Settings	You can make the basic print settings such as paper type and print quality.
Two-sided Printing Settings	You can select a binding direction for 2-sided printing or select a document type. This menu is only displayed for automatic 2-sided printing capable models.
Layout	You can select a layout for printing several pages on one sheet or select to print a border.
Paper Handling	You can reduce or enlarge the size of the print job to automatically fit the paper size you loaded.
Color Matching	You can adjust the colors.

## Application Information

### Note:

On Mac OS X v10.8.x or later, if **Print Settings** menu is not displayed, Epson printer driver has not been installed correctly.

Select **System Preferences** from the  menu > **Printers & Scanners** (or **Print & Scan**, **Print & Fax**), remove the printer, and then add the printer again. See the following to add a printer.

<http://epson.sn>

### Epson Printer Utility

You can run a maintenance feature such as nozzle check and print head cleaning, and by starting **EPSON Status Monitor**, you can check printer status and error information.

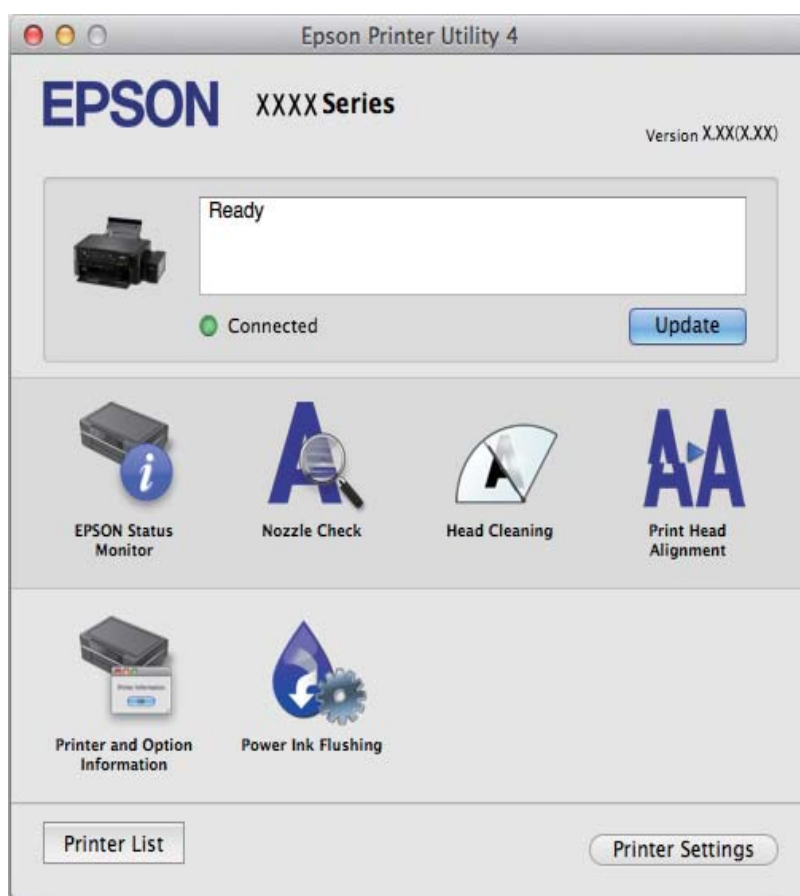

## Making Operation Settings for the Mac OS X Printer Driver

You can make various settings such as skipping blank pages and enabling/disabling high speed printing.

1. Select **System Preferences** from the  menu > **Printers & Scanners** (or **Print & Scan**, **Print & Fax**), and then select the printer. Click **Options & Supplies** > **Options** (or **Driver**).
2. Make the appropriate settings, and then click **OK**.
  - Thick paper and envelopes: Prevents the ink from smearing when printing on thick paper. However, the print speed may be slower.
  - Skip Blank Page: Avoids printing blank pages.
  - Quiet Mode: Prints quietly. However, the print speed may be slower.
  - Permit temporary black printing: Prints only with black ink temporarily.

## Application Information

- High Speed Printing: Prints when the print head moves in both directions. The print speed is faster, but the quality may decline.
- Warning Notifications: Allows the printer driver to display warning notifications.
- Establish bidirectional communication: Usually, this should be set to **On**. Select **Off** when acquiring the printer information is impossible because the printer is shared with Windows computers on a network or for any other reason.
- Lower Cassette: Add the optional paper cassette units to the paper source.

**Note:**

*The availability of these settings varies by model.*

## EPSON Scan (Scanner Driver)

EPSON Scan is an application for controlling scanning. You can adjust the size, resolution, brightness, contrast, and quality of the scanned image.

**Note:**

*You can also start EPSON Scan from a TWAIN-compliant scanning application.*

### Starting on Windows

- Windows 8.1/Windows 8

Enter the application name in the search charm, and then select the displayed icon.

- Except for Windows 8.1/Windows 8

Click the start button, and select **All Programs** or **Programs > EPSON > EPSON Scan > EPSON Scan**.

### Starting on Mac OS X

**Note:**

*EPSON Scan does not support the Mac OS X fast user switching feature. Turn off fast user switching.*

Select **Go > Applications > Epson Software > EPSON Scan**.

## Epson Event Manager

Epson Event Manager is an application that allows you to manage scanning from the control panel and save images to a computer. You can add your own settings as presets, such as the document type, the save folder location, and the image format. See the application's help for details.

### Starting on Windows

- Windows 8.1/Windows 8

Enter the application name in the search charm, and then select the displayed icon.

- Except for Windows 8.1/Windows 8

Click the start button, and select **All Programs** or **Programs > Epson Software > Event Manager**.

### Starting on Mac OS X

Select **Go > Applications > Epson Software > Event Manager**.

## Application Information

### Related Information

➔ [“Scanning from the Control Panel” on page 39](#)

## Epson Easy Photo Print

Epson Easy Photo Print is an application that allows you to easily print photos with various layouts. You can preview the photo image and adjust the images or position. You can also print photos with a frame. See the application's help for details.

**Note:**

*To use this application, the printer driver needs to be installed.*

### Starting on Windows

- Windows 8.1/Windows 8

Enter the application name in the search charm, and then select the displayed icon.

- Except for Windows 8.1/Windows 8

Click the start button, and then select **All Programs** or **Programs** > **Epson Software** > **Epson Easy Photo Print**.

### Starting on Mac OS X

Select **Go** > **Applications** > **Epson Software** > **Epson Easy Photo Print**.

## E-Web Print (for Windows Only)

E-Web Print is an application that allows you to easily print web pages with various layouts. See the application's help for details. You can access the help from the **E-Web Print** menu on the **E-Web Print** tool bar.

### Starting

When you install E-Web Print, it is displayed in your browser. Click **Print** or **Clip**.

## EPSON Software Updater

EPSON Software Updater is an application that checks for new or updated software on the internet and installs it. You can also update the printer's firmware and manual.

### Starting on Windows

- Windows 8.1/Windows 8

Enter the application name in the search charm, and then select the displayed icon.

- Except for Windows 8.1/Windows 8

Click the start button, and select **All Programs** (or **Programs**) > **Epson Software** > **EPSON Software Updater**.

**Note:**

*You can also start EPSON Software Updater by clicking the printer icon on the task bar on the desktop, and then selecting **Software Update**.*

### Starting on Mac OS X

Select **Go** > **Applications** > **Epson Software** > **EPSON Software Updater**.

---

## Uninstalling Applications

**Note:**

Log on to your computer as an administrator. Enter the administrator password if the computer prompts you.

### Uninstalling Applications - Windows



1. Press the  button to turn off the printer.
2. Quit all running applications.
3. Open **Control Panel**:
  - Windows 8.1/Windows 8  
Select **Desktop > Settings > Control Panel**.
  - Except for Windows 8.1/Windows 8  
Click the start button and select **Control Panel**.
4. Open **Uninstall a program** (or **Add or Remove Programs**):
  - Windows 8.1/Windows 8/Windows 7/Windows Vista  
Select **Uninstall a program** in **Programs**.
  - Windows XP  
Click **Add or Remove Programs**.
5. Select the application you want to uninstall.
6. Uninstall the applications:
  - Windows 8.1/Windows 8/Windows 7/Windows Vista  
Click **Uninstall/Change** or **Uninstall**.
  - Windows XP  
Click **Change/Remove** or **Remove**.

**Note:**

If the **User Account Control** window is displayed, click **Continue**.

7. Follow the on-screen instructions.

### Uninstalling Applications - Mac OS X

1. Download the Uninstaller using EPSON Software Updater.  
Once you have downloaded the Uninstaller, you do not need to download it again each time you uninstall the application.
2. Turn off the printer by pressing the  button.
3. To uninstall the printer driver, select **System Preferences** from the  menu > **Printers & Scanners** (or **Print & Scan, Print & Fax**), and then remove the printer from the enabled printers list.

## Application Information

4. Quit all running applications.
5. Select **Go > Applications > Epson Software > Uninstaller**.
6. Select the application you want to uninstall, and then click **Uninstall**.

**Important:**

*The Uninstaller removes all drivers for Epson inkjet printers on the computer. If you use multiple Epson inkjet printers and you only want to delete some drivers, delete all of them first, and then install the necessary printer driver again.*

**Note:**

*If you cannot find the application you want to uninstall in the application list, you cannot uninstall using the Uninstaller. In this situation, select **Go > Applications > Epson Software**, select the application you want to uninstall, and then drag it to the trash icon.*

**Related Information**

➔ [“EPSON Software Updater” on page 62](#)

---

## Installing Applications

If your computer is connected to a network, install the latest applications available on the website. If you are unable to download the applications from the website, install them from the software disc that came with the printer.

**Note:**

- Log on to your computer as an administrator. Enter the administrator password if the computer prompts you.
- When reinstalling an application, you need to uninstall it first.

1. Quit all running applications.
2. When installing the printer driver or EPSON Scan, disconnect the printer and the computer temporarily.

**Note:**

*Do not connect the printer and the computer until you are instructed to do so.*

3. Install the applications by following the instructions on the website below.

<http://epson.sn>

**Related Information**

➔ [“Uninstalling Applications” on page 63](#)

---

## Updating Applications and Firmware

You may be able to clear certain problems and improve or add functions by updating the applications and the firmware. Make sure you use the latest version of the applications and firmware.

1. Make sure that the printer and the computer are connected, and the computer is connected to the internet.



## Application Information

2. Start EPSON Software Updater, and update the applications or the firmware.



**Important:**

*Do not turn off the computer or the printer while updating.*

**Note:**

*If you cannot find the application you want to update in the list, you cannot update using the EPSON Software Updater. Check for the latest versions of the applications from your local Epson website.*

<http://www.epson.com>

### Related Information

- ➔ [“EPSON Software Updater” on page 62](#)

# Solving Problems

## Checking the Printer Status















### Checking the Error Indicators on the Printer

When an error occurs, the light turns on or flashes. Details of the error are displayed on the computer screen.

: On

: Flashing slowly

: Flashing fast

Light	Situation	Solutions
	No paper is loaded or more than one sheet has been fed at a time.	Load paper and press the  or  button.
	A paper jam has occurred.	Remove the paper and press the  or  button.
	Initial ink charging may not be complete.	See the <i>Start Here</i> poster to complete initial ink charging.
	The  light and  light flash alternately. An ink pad is nearing or at the end of its service life.	The ink pads need to be replaced. Contact Epson or an authorised Epson service provider to replace the ink pad*. It is not a user-serviceable part. When a message saying that you can continue printing is displayed on the computer, press the  or  button to continue printing. The lights stop flashing for the time being, however, they will continue to flash at regular intervals until the ink pad is replaced.
	A printer error has occurred.	Open the scanner unit and remove any paper or protective material inside the printer. Turn the power off and on again.
	The printer has started in recovery mode because the firmware update failed.	Follow the steps below to try to update the firmware again. 1. Connect the computer and the printer with a USB cable. 2. Visit your local Epson website for further instructions.

\* In some print cycles a very small amount of surplus ink may be collected in the ink pad. To prevent ink leakage from the pad, the printer is designed to stop printing when the pad has reached its limit. Whether and how often

## Solving Problems

this is required will vary according to the number of pages you print, the type of material that you print and the number of cleaning cycles that the printer performs. The need for replacement of the pad does not mean that your printer has ceased to operate in accordance with its specifications. The printer will advise you when the pad requires replacing and this can only be performed by an authorised Epson Service provider. The Epson warranty does not cover the cost of this replacement.

### Related Information

- ➔ [“Contacting Epson Support” on page 87](#)
- ➔ [“Installing Applications” on page 64](#)
- ➔ [“Updating Applications and Firmware” on page 64](#)

## Checking the Printer Status - Windows

1. Access the printer driver window.
2. Click **EPSON Status Monitor 3** on the **Maintenance** tab.

### Note:

- You can also check the printer status by double-clicking the printer icon on the taskbar. If the printer icon is not added to the taskbar, click **Monitoring Preferences** on the **Maintenance** tab, and then select **Register the shortcut icon to the taskbar**.
- If **EPSON Status Monitor 3** is disabled, click **Extended Settings** on the **Maintenance** tab, and then select **Enable EPSON Status Monitor 3**.

### Related Information

- ➔ [“Windows Printer Driver” on page 55](#)

## Checking Printer Status - Mac OS X

1. Select **System Preferences** from the  menu > **Printers & Scanners** (or **Print & Scan, Print & Fax**), and then select the printer.
2. Click **Options & Supplies** > **Utility** > **Open Printer Utility**.
3. Click **EPSON Status Monitor**.

---

## Removing Jammed Paper

Check the error displayed on the control panel and follow the instructions to remove the jammed paper including any torn pieces. Next, clear the error.



### Important:

*Remove the jammed paper carefully. Removing the paper vigorously may cause damage to the printer.*

### Related Information

- ➔ [“Checking the Error Indicators on the Printer” on page 66](#)

## Solving Problems

### Removing Jammed Paper from the Rear Paper Feed

Remove the jammed paper.

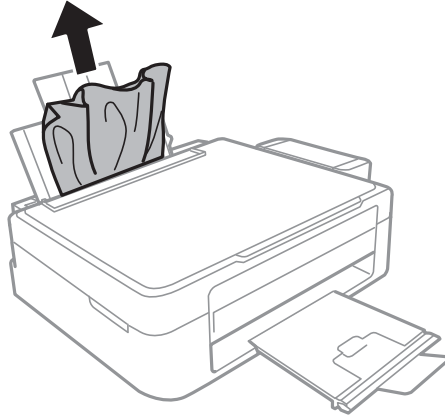

### Removing Jammed Paper from Inside the Printer



**Caution:**

- Be careful not to trap your hand or fingers when opening or closing the scanner unit. Otherwise you may be injured.
- Never touch the buttons on the control panel while your hand is inside the printer. If the printer starts operating, it could cause an injury. Be careful not to touch the protruding parts to avoid injury.

1. Open the scanner unit with the document cover closed.

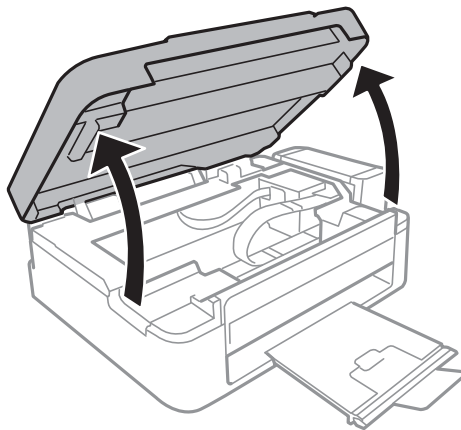

## Solving Problems

2. Remove the jammed paper.

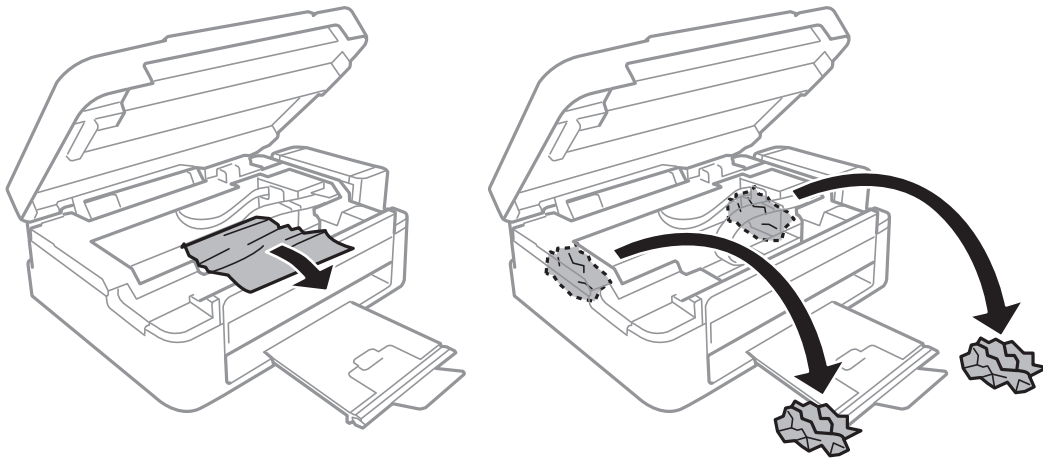

**!** **Important:**

*Do not touch the white flat cable, translucent part, and ink tubes inside the printer. Doing so may cause a malfunction.*

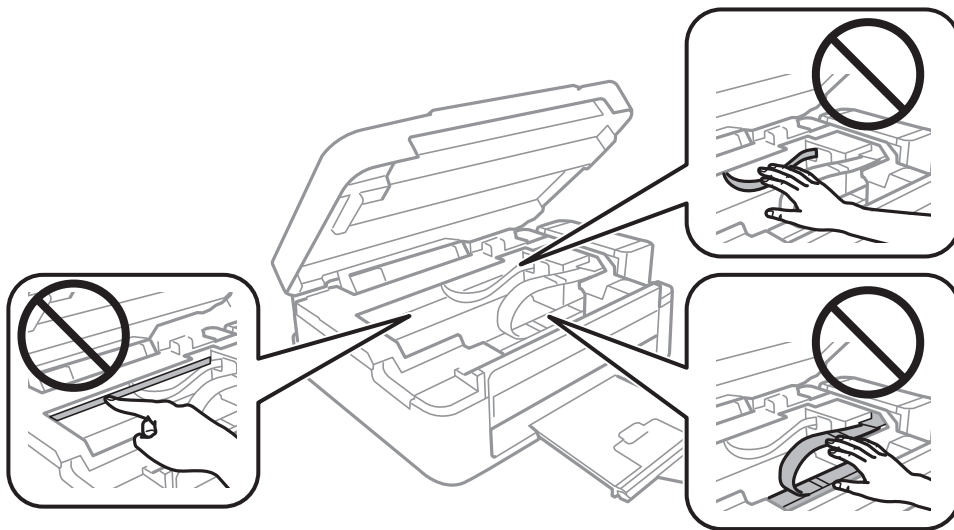

3. Close the scanner unit.

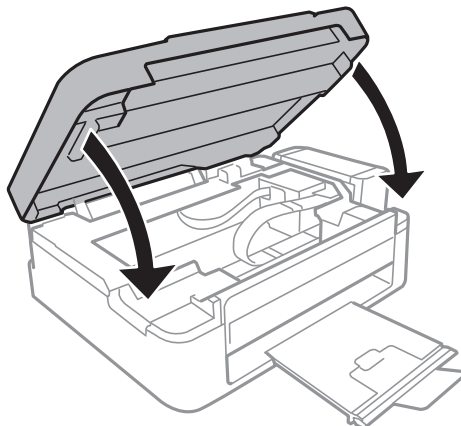

---

## Paper Does Not Feed Correctly

Check the following if the paper jams, paper is fed at a slant, several sheets of paper are fed at a time, no paper is fed, or paper is ejected.

- Place the printer on a flat surface and operate in the recommended environmental conditions.
- Use paper supported by this printer.
- Follow the paper handling precautions.
- Load paper in the correct direction, and slide the edge guide against the edge of the paper.
- Do not load more than the maximum number of sheets specified for the paper. For plain paper, do not load above the line indicated by the triangle symbol on the edge guide.
- When a paper out error occurs although paper is loaded in the printer, reload paper against the right edge of the rear paper feed.
- Load one sheet of paper at a time when loading multiple sheets of paper.
- When several sheets of paper are fed at a time during manual 2-sided printing, remove any paper which is loaded in the paper source before you reload the paper.
- Printing may have been paused for a certain length of time which causes the printer to eject the paper.

### Related Information

- ➔ [“Environmental Specifications” on page 82](#)
- ➔ [“Available Paper and Capacities” on page 15](#)
- ➔ [“Paper Handling Precautions” on page 14](#)
- ➔ [“Loading Paper in the Rear Paper Feed” on page 16](#)



---

## Power and Control Panel Problems

### Power Does Not Turn On

- Hold down the  button for a little longer.
- Make sure the power cord is securely plugged in.

### Power Does Not Turn Off

Hold down the  button for a little longer. If you still cannot turn off the printer, unplug the power cord. To prevent the print head from drying out, turn the printer back on and turn it off by pressing the  button.

---

## Printer Does Not Print

Check the following if the printer does not operate or prints nothing.

- Install the printer driver.
- To print photos easily, install Epson Easy Photo Print.

## Solving Problems

- Connect the USB cord securely to the printer and the computer.
- If you are using a USB hub, try to connect the printer directly to the computer.
- If you are printing a large data size image, the computer may run out of memory. Print the image at a lower resolution or a smaller size.
- In Windows, click **Print Queue** on the printer driver's **Maintenance** tab, and then check the following.
  - Check if there are any paused print jobs.  
Cancel printing if necessary.
  - Make sure the printer is not offline or pending.  
If the printer is offline or pending, clear the offline or pending setting from the **Printer** menu.
  - Make sure the printer is selected as the default printer from the **Printer** menu (there should be a check mark on the menu item).  
If the printer is not selected as the default printer, set it as the default printer.
- In Mac OS X, make sure the printer status is not **Pause**.  
Select **System Preferences** from the  menu > **Printers & Scanners** (or **Print & Scan, Print & Fax**), and then double-click the printer. If the printer is paused, click **Resume** (or **Resume Printer**).
- Run the nozzle check, and then clean the print head if any of the print head nozzles are clogged.

### Related Information

- ➔ [“Installing Applications” on page 64](#)
- ➔ [“Epson Easy Photo Print” on page 62](#)
- ➔ [“Canceling Printing” on page 36](#)
- ➔ [“Checking and Cleaning the Print Head” on page 50](#)

---

## Printout Problems

### Print Quality Is Poor

Check the following if the print quality is poor due to blurry prints, banding, missing colors, faded colors, misalignment, and mosaic-like patterns in the prints.

- Make sure the initial ink charging is complete.
- Check the ink tank. If the tank is empty, refill the ink immediately and clean the print head.
- Run the nozzle check and then clean the print head if any of the print head nozzles are clogged.
- If you have not used the printer for a long time, use the Power Ink Flushing utility of the printer driver.
- Align the print head.
- If misalignment appears at intervals of 2.5 cm, align the print head.
- Use paper supported by this printer.
- Do not print on paper that is damp, damaged, or too old.
- If the paper is curled or the envelope is puffed up, flatten it.
- When printing images or photos, print using high-resolution data. Images on websites are often low resolution although they look good enough on the display, and so print quality may decline.

## Solving Problems

- Select the appropriate paper type setting in the printer driver for the type of paper loaded in the printer.
- Print using a high quality setting in the printer driver.
- When images or photos are printed in unexpected colors, adjust the color and then print again. The automatic color correction feature uses the standard correction mode in **PhotoEnhance**. Try another correction mode in **PhotoEnhance** by selecting an option other than **Auto Correct** as the **Scene Correction** setting. If the problem continues, use any other color correction feature other than **PhotoEnhance**.
- Disable the bidirectional (or high speed) setting. When this setting is enabled, the print head prints while moving in both directions, and vertical lines may be misaligned. If you disable this feature, printing may slow down.
  - Windows
    - Clear **High Speed** on the printer driver's **More Options** tab.
  - Mac OS X
    - Select **System Preferences** from the  menu > **Printers & Scanners** (or **Print & Scan, Print & Fax**), and then select the printer. Click **Options & Supplies** > **Options** (or **Driver**). Select **Off** as the **High Speed Printing** setting.
- Do not stack the paper immediately after printing.
- Dry the printouts completely before filing or displaying them. When drying the printouts, avoid direct sun light, do not use a dryer, and do not touch the printed side of paper.
- Try to use genuine Epson ink bottles. This product is designed to adjust colors based on the use of genuine Epson ink bottles. The use of non-genuine ink bottles may cause print quality to decline.
- Use ink bottles with the correct part code for this printer.
- Epson recommends using the ink bottle before the date printed on the package.
- When printing images or photos, Epson recommends using genuine Epson paper rather than plain paper. Print on the printable side of the genuine Epson paper.

### Related Information

- ➔ [“Refilling the Ink Tanks” on page 46](#)
- ➔ [“Checking and Cleaning the Print Head” on page 50](#)
- ➔ [“Replacing Ink inside the Ink Tubes” on page 52](#)
- ➔ [“Aligning the Print Head” on page 53](#)
- ➔ [“Paper Handling Precautions” on page 14](#)
- ➔ [“Available Paper and Capacities” on page 15](#)
- ➔ [“List of Paper Types” on page 15](#)
- ➔ [“Adjusting the Print Color” on page 35](#)

## Copy Quality Is Poor

Check the following if uneven colors, smears, dots, or straight lines appear in the copied image.

- Load and eject paper without printing to clean the paper path.
- Clean the scanner glass and the document cover.
- Do not press too hard on the original or the document cover when you are placing the originals on the scanner glass. Uneven colors, smears, or dots may appear when the original or the document cover are pressed too hard.



## Solving Problems

### Related Information

- ➔ [“Cleaning the Paper Path” on page 53](#)
- ➔ [“Cleaning the Scanner Glass” on page 54](#)
- ➔ [“Print Quality Is Poor” on page 71](#)

## An Image of the Reverse Side of the Original Appears in the Copied Image

- For a thin original, place the original on the scanner glass and then place a piece of black paper over it.

## The Position, Size, or Margins of the Printout Are Incorrect

- Load paper in the correct direction, and slide the edge guide against the edges of the paper.
- When placing the originals on the scanner glass, align the corner of the original with the corner indicated by a symbol on the frame of the scanner glass. If the edges of the copy are cropped off, move the original slightly away from the corner.
- Clean the scanner glass and the document cover. If there is dust or stains on the glass, the copy area may extend to include the dust or stains, resulting in the wrong printing position or small images.
- Select the appropriate paper size setting in the printer driver.
- Adjust the margin setting in the application so that it falls within the printable area.

### Related Information

- ➔ [“Loading Paper in the Rear Paper Feed” on page 16](#)
- ➔ [“Placing Originals on the Scanner Glass” on page 19](#)
- ➔ [“Cleaning the Scanner Glass” on page 54](#)
- ➔ [“Printable Area” on page 80](#)

## Paper Is Smearred or Scuffed

Check the following if the paper is smeared or scuffed when printing.

- Clean the paper path.
- Clean the scanner glass and the document cover.
- Load paper in the correct direction.
- When performing manual 2-sided printing, make sure that the ink is completely dry before reloading the paper.

### Related Information

- ➔ [“Cleaning the Paper Path” on page 53](#)
- ➔ [“Cleaning the Scanner Glass” on page 54](#)
- ➔ [“Loading Paper in the Rear Paper Feed” on page 16](#)
- ➔ [“Print Quality Is Poor” on page 71](#)

## Printed Characters Are Incorrect or Garbled

- Connect the USB cord securely to the printer and the computer.
- Cancel any paused print jobs.
- Do not put the computer manually into the **Hibernate** mode or the **Sleep** mode while printing. Pages of garbled text may be printed next time you start the computer.

### Related Information

➔ [“Canceling Printing” on page 36](#)

## The Printed Image Is Inverted

Clear any mirror image settings in the printer driver or the application.

- Windows
  - Clear **Mirror Image** on the printer driver's **More Options** tab.
- Mac OS X
  - Clear **Mirror Image** from the print dialog's **Print Settings** menu.

## The Printout Problem Could Not be Cleared

If you have tried all of the solutions and have not solved the problem, try uninstalling and then reinstalling the printer driver.

### Related Information

- ➔ [“Uninstalling Applications” on page 63](#)
- ➔ [“Installing Applications” on page 64](#)

---

## Other Printing Problems

### Printing Is Too Slow

- Close any unnecessary applications.
- Lower the quality setting on the printer driver. High quality printing slows down the printing speed.
- Enable the bidirectional (or high speed) setting. When this setting is enabled, the print head prints while moving in both directions, and the printing speed increases.
  - Windows
    - Select **High Speed** on the printer driver's **More Options** tab.
  - Mac OS X
    - Select **System Preferences** from the  menu > **Printers & Scanners** (or **Print & Scan**, **Print & Fax**), and then select the printer. Click **Options & Supplies** > **Options** (or **Driver**). Select **On** as the **High Speed Printing** setting.

## Solving Problems

- ❑ Disable quiet mode. This feature slows down the printing speed.
  - ❑ Windows
    - Disable the **Quiet Mode** setting on the printer driver's **Main** tab.
  - ❑ Mac OS X
    - Select **System Preferences** from the  menu > **Printers & Scanners** (or **Print & Scan**, **Print & Fax**), and then select the printer. Click **Options & Supplies** > **Options** (or **Driver**). Select **Off** as the **Quiet Mode** setting.

## Printing Slows Down Dramatically During Continuous Printing

Printing slows down to prevent the printer mechanism from overheating and being damaged. However, you can continue printing.

To return to normal printing speed, leave the printer idle for at least 30 minutes. Printing speed does not return to normal if the power is off.

---

## Cannot Start Scanning

- ❑ Connect the interface cable securely to the printer and the computer.
- ❑ If you are using a USB hub, try to connect the printer directly to the computer.
- ❑ Make sure you select the correct printer (scanner) if a scanner list is displayed when you start EPSON Scan.
- ❑ If you are using any TWAIN-compliant applications, select the printer (scanner) you are using.
- ❑ In Windows, make sure the printer (scanner) is displayed in **Scanner and Camera**. The printer (scanner) should be displayed as "EPSON XXXXX (printer name)". If the printer (scanner) is not displayed, uninstall and then re-install EPSON Scan. See the following to access **Scanner and Camera**.
  - ❑ Windows 8.1/Windows 8
    - Select **Desktop** > **Settings** > **Control Panel**, enter "Scanner and Camera" in the search charm, click **Show Scanner and Camera**, and then check if the printer is displayed.
  - ❑ Windows 7
    - Click the start button and select **Control Panel**, enter "Scanner and Camera" in the search charm, click **View scanners and cameras**, and then check if the printer is displayed.
  - ❑ Windows Vista
    - Click the start button, select **Control Panel** > **Hardware and Sound** > **Scanners and Cameras**, and then check if the printer is displayed.
  - ❑ Windows XP
    - Click the start button, select **Control Panel** > **Printers and Other Hardware** > **Scanner and Cameras**, and then check if the printer is displayed.
- ❑ If you cannot scan using any TWAIN-compliant applications, uninstall and then reinstall the TWAIN compliant application.
- ❑ For Mac OS X with an Intel processor, if other Epson scanner drivers except for EPSON Scan, such as Rosetta or PPC are installed, uninstall them and EPSON Scan, and then reinstall EPSON Scan.

### Related Information

- ➔ [“Uninstalling Applications” on page 63](#)

## Solving Problems

➔ [“Installing Applications” on page 64](#)

### Cannot Start Scanning when Using the Control Panel

- Make sure EPSON Scan and Epson Event Manager are installed correctly.
- Check the scanning setting assigned in Epson Event Manager.

#### Related Information

➔ [“Epson Event Manager” on page 61](#)

---

## Scanned Image Problems

### Scan Quality Is Poor

- Clean the scanner glass and the document cover.
- Do not press too hard on the original or the document cover when you are placing the originals on the scanner glass. Uneven colors, smears, or dots may appear when the original or the document cover are pressed too hard.
- Remove dust from the original.
- Scan at a higher resolution.
- Adjust the image in EPSON Scan, and then scan. See the EPSON Scan help for details.

#### Related Information

➔ [“Cleaning the Scanner Glass” on page 54](#)

### Characters Are Blurred

- In **Home Mode** or **Office Mode** in EPSON Scan, select **Image Option** as the **Image Adjustments** setting, and then select **Text Enhancement**.
- In **Professional Mode** in EPSON Scan, select **Document** as the **Auto Exposure Type** in the **Original** settings.
- Adjust the threshold settings in EPSON Scan.
  - Home Mode**  
Select **Black & White** as the **Image Type** setting, click **Brightness**, and then adjust the threshold.
  - Office Mode**  
Select **Black & White** as the **Image Type** setting, and then adjust the threshold.
  - Professional Mode**  
Select **Black & White** as the **Image Type** setting, and then adjust the threshold setting.
- Scan at a higher resolution.

## Solving Problems

### An Image of the Reverse Side of the Original Appears in the Scanned Image

- ❑ For a thin original, place the original on the scanner glass and then place a piece of black paper over it.
- ❑ Make the appropriate document type settings in EPSON Scan.
- ❑ In **Home Mode** or **Office Mode** in EPSON Scan, select **Image Option** as the **Image Adjustments** setting, and then select **Text Enhancement**.

### Moire (Cross-Hatch) Patterns Appear in the Scanned Image

- ❑ Place the original at a slightly different angle.
- ❑ Select **Descreening** in any mode other than **Full Auto Mode** in EPSON Scan.
- ❑ Change the resolution setting in EPSON Scan.

### Scanning Area or Direction Is Not Correct

- ❑ When placing the originals on the scanner glass, align the corner of the original with the corner indicated by a symbol on the frame of the scanner glass. If the edges of the scanned image are cropped off, move the original slightly away from the corner.
- ❑ Clean the scanner glass and the document cover. If there is dust or stains on the glass, the scanning area may extend to include the dust or stains, resulting in the wrong scanning position or small images.
- ❑ When you place multiple originals on the scanner glass to scan them separately, but they are scanned onto a single file, place the originals at least 20 mm (0.8 inch) apart. If the problem continues, place one original at a time.
- ❑ When scanning using **Full Auto Mode** or the thumbnail preview in EPSON Scan, move the original 4.5 mm (0.18 inch) away from the edges of the scanner glass.
- ❑ When using the thumbnail preview for a large original in **Home Mode** or **Professional Mode** in EPSON Scan, the scanning area may not be correct. When previewing in EPSON Scan, create marquees of the area you want to scan on the **Preview** tab in the **Preview** window.
- ❑ If **Auto Photo Orientation** in EPSON Scan does not work as intended, see the EPSON Scan help.
- ❑ Clear **Auto Photo Orientation** in EPSON Scan.
- ❑ When scanning with EPSON Scan the available scanning area may be restricted if the resolution setting is too high. Lower the resolution or adjust the scanning area in the **Preview** window.

#### Related Information

- ➔ [“Placing Originals on the Scanner Glass” on page 19](#)
- ➔ [“Cleaning the Scanner Glass” on page 54](#)

### The Scanned Image Problem Could Not be Cleared

If you have tried all of the solutions and could not solve the problem, click **Configuration** in a mode other than **Full Auto Mode** in the EPSON Scan window, and then click **Reset All** on the **Other** tab to initialize the EPSON Scan settings. If initialization does not solve the problem uninstall and re-install EPSON Scan.

**Related Information**

- ➔ [“Uninstalling Applications” on page 63](#)
- ➔ [“Installing Applications” on page 64](#)

---

## Other Scanning Problems

### Cannot Scan in Full Auto Mode in EPSON Scan

- You cannot scan to PDF/Multi-TIFF format continuously in **Full Auto Mode**. Scan in a mode other than **Full Auto Mode**.
- See the EPSON Scan help for other way of solving problems.

### Thumbnail Preview Does Not Work Properly

See the EPSON Scan help.

**Related Information**

- ➔ [“EPSON Scan \(Scanner Driver\)” on page 61](#)

### Scanning Is Too Slow

Lower the resolution.

### Scanning Stops when Scanning to PDF/Multi-TIFF

- When scanning large volumes, we recommend scanning in grayscale.
- Increase the free space on the computer's hard disk. Scanning may stop if there is not enough free space.
- Try scanning at a lower resolution. Scanning stops if the total data size reaches the limit.

---

## Other Problems

### Slight Electric Shock when Touching the Printer

If many peripherals are connected to the computer, you may feel a slight electric shock when touching the printer. Install a ground wire to the computer that is connected to the printer.

### Operation Sounds Are Loud

If operations sounds are too loud, enable quiet mode. However, this may slow down printer operations.

- Windows printer driver
  - Select **On** as the **Quiet Mode** setting on the **Main** tab.

## Solving Problems

### Mac OS X printer driver

Select **System Preferences** from the  menu > **Printers & Scanners** (or **Print & Scan, Print & Fax**), and then select the printer. Click **Options & Supplies** > **Options** (or **Driver**). Select **On** as the **Quiet Mode** setting.

## **Application Is Blocked by a Firewall (for Windows Only)**

Add the application to the Windows Firewall allowed program in security settings on the **Control Panel**.

# Appendix

## Technical Specifications

### Printer Specifications

Print Head Nozzle Placement		Black ink nozzles: 180 Color ink nozzles: 59 for each color
Weight of Paper	Plain Paper	64 to 90 g/m <sup>2</sup> (17 to 24lb)
	Envelopes	Envelope #10, DL, C6: 75 to 90 g/m <sup>2</sup> (20 to 24 lb)

### Printable Area

Print quality may decline in the shaded areas due to the printer's mechanism.

#### Single sheets (normal printing)

	A	3.0 mm (0.12 in.)
	B	3.0 mm (0.12 in.)
	C	40.0 mm (1.57 in.)
	D	32.0 mm (1.26 in.)

#### Envelopes

	A	3.0 mm (0.12 in.)
	B	5.0 mm (0.20 in.)
	C	18.0 mm (0.71 in.)
	D	40.0 mm (1.57 in.)

### Scanner Specifications

Scanner Type	Flatbed
Photoelectric Device	CIS
Maximum Document Size	216 × 297 mm (8.5 × 11.7 in.) A4, Letter



## Appendix

Resolution	600 dpi (main scan) 1200 dpi (sub scan)
Color Depth	Color <input type="checkbox"/> 48 bits per pixel internal (16 bits per pixel per color internal) <input type="checkbox"/> 24 bits per pixel external (8 bits per pixel per color external) Grayscale <input type="checkbox"/> 16 bits per pixel internal <input type="checkbox"/> 8 bits per pixel external Black and white <input type="checkbox"/> 16 bits per pixel internal <input type="checkbox"/> 1 bits per pixel external
Light Source	LED

## Interface Specifications

For Computer	USB
--------------	-----

## Dimensions

Dimensions	Storage <input type="checkbox"/> Width: 482 mm (19.0 in.) <input type="checkbox"/> Depth: 300 mm (11.8 in.) <input type="checkbox"/> Height: 145 mm (5.7 in.) Printing <input type="checkbox"/> Width: 482 mm (19.0 in.) <input type="checkbox"/> Depth: 528 mm (20.8 in.) <input type="checkbox"/> Height: 279 mm (11.0 in.)
Weight*	Approx. 4.3 kg (9.5 lb)

\* Without the ink and the power cord.

## Electrical Specifications

Model	100 to 240 V Model	220 to 240 V Model
Rated Frequency Range	50 to 60 Hz	50 to 60 Hz
Rated Current	0.5 to 0.3 A	0.3 A

## Appendix

Power Consumption (with USB Connection)	Standalone copying: Approx. 12 W (ISO/IEC24712) Ready mode: Approx. 3.8 W Sleep mode: Approx. 0.8 W Power off: Approx. 0.3 W	Standalone copying: Approx. 12 W (ISO/IEC24712) Ready mode: Approx. 3.8 W Sleep mode: Approx. 0.8 W Power off: Approx. 0.3 W
---	---	---

**Note:**

- Check the label on the printer for its voltage.

## Environmental Specifications

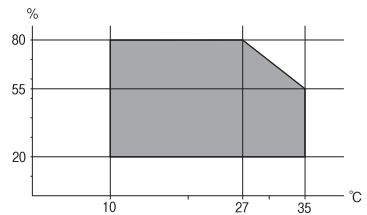
Operation	Use the printer within the range shown in the following graph.  Temperature: 10 to 35°C (50 to 95°F) Humidity: 20 to 80% RH (without condensation)
Storage	Temperature: -20 to 40°C (-4 to 104°F)* Humidity: 5 to 85% RH (without condensation)

- \* You can store for one month at 40°C (104°F).

## Environmental Specifications for Ink Bottles

Storage Temperature	-20 to 40 °C (-4 to 104 °F)*
Freezing Temperature	-15 °C (5 °F) Ink thaws and is usable after approximately 2 hours at 25 °C (77 °F).

- \* You can store for one month at 40 °C (104 °F).

## System Requirements

- Windows 8.1 (32-bit, 64-bit)/Windows 8 (32-bit, 64-bit)/Windows 7 (32-bit, 64-bit)/Windows Vista (32-bit, 64-bit)/Windows XP Professional x64 Edition/Windows XP (32-bit)
- Mac OS X v10.9.x/Mac OS X v10.8.x/Mac OS X v10.7.x/Mac OS X v10.6.8

**Note:**

- Mac OS X may not support some applications and features.
- The UNIX File System (UFS) for Mac OS X is not supported.

---

## Regulatory Information

### Standards and Approvals for European Model

Low voltage directive 2006/95/EC	EN60950-1
EMC directive 2004/108/EC	EN55022 Class B EN61000-3-2 EN61000-3-3 EN55024

### Restrictions on Copying

Observe the following restrictions to ensure the responsible and legal use of the printer.

Copying of the following items is prohibited by law:

- Bank bills, coins, government-issued marketable securities, government bond securities, and municipal securities
- Unused postage stamps, pre-stamped postcards, and other official postal items bearing valid postage
- Government-issued revenue stamps, and securities issued according to legal procedure

Exercise caution when copying the following items:

- Private marketable securities (stock certificates, negotiable notes, checks, etc.), monthly passes, concession tickets, etc.
- Passports, driver's licenses, warrants of fitness, road passes, food stamps, tickets, etc.

**Note:**

*Copying these items may also be prohibited by law.*

Responsible use of copyrighted materials:

Printers can be misused by improperly copying copyrighted materials. Unless acting on the advice of a knowledgeable attorney, be responsible and respectful by obtaining the permission of the copyright holder before copying published material.

---

## Checking the Total Number of Pages Fed Through the Printer



You can check the total number of pages fed through the printer.

### Checking the Total Number of Pages Fed Through the Printer - Control Panel

The information is printed together with the nozzle check pattern.

1. Load A4-size plain paper in the printer.

## Appendix

2. Press the  button to turn off the printer.
3. Turn the printer on while holding the  button down, and then release the buttons when the power light flashes.

The nozzle check pattern is printed.

### Checking the Total Number of Pages Fed Through the Printer - Windows

1. Access the printer driver window.
2. Click **Printer and Option Information** on the **Maintenance** tab.

### Checking the Total Number of Pages Fed Through the Printer - Mac OS X

1. Select **System Preferences** from the  menu > **Printers & Scanners** (or **Print & Scan**, **Print & Fax**), and then select the printer.
2. Click **Options & Supplies** > **Utility** > **Open Printer Utility**.
3. Click **Printer and Option Information**.

---

## Saving Power

The printer enters sleep mode or turns off automatically if no operations are performed for a set period. You can adjust the time before power management is applied. Any increase will affect the printer's energy efficiency. Please consider the environment before making any change.

### Saving Power - Windows

1. Access the printer driver window.
2. Click **Printer and Option Information** on the **Maintenance** tab.
3. Select the time period before the printer enters sleep mode as the **Sleep Timer** setting, and click **Send**. To make the printer turn off automatically, select the time period as the **Power Off Timer** setting, and click **Send**.
4. Click **OK**.

### Saving Power - Mac OS X

1. Select **System Preferences** from the  menu > **Printers & Scanners** (or **Print & Scan**, **Print & Fax**), and then select the printer.
2. Click **Options & Supplies** > **Utility** > **Open Printer Utility**.

## Appendix

3. Click **Printer Settings**.
4. Select the time period before the printer enters sleep mode as the **Sleep Timer** setting, and click **Apply**. To make the printer turn off automatically, select the time period as the **Power Off Timer** setting, and click **Apply**.

---

## Transporting the Printer

When you need to transport the printer to move or for repairs, follow the steps below to pack the printer.

 **Important:**

- When storing or transporting the printer, avoid tilting it, placing it vertically, or turning it upside down; otherwise ink may leak.
- When storing or transporting an ink bottle after removing its seal, do not tilt the bottle and do not subject it to impacts or temperature changes. Otherwise, ink may leak even if the cap on the ink bottle is tightened securely. Be sure to keep the ink bottle upright when tightening the cap, and take measures to prevent ink from leaking when you transport the bottle.
- Do not put opened ink bottles in the box with printer.

1. Turn off the printer by pressing the  button.
2. Make sure the power light turns off, and then unplug the power cord.

 **Important:**

*Unplug the power cord when the power light is off. Otherwise, the print head does not return to the home position causing the ink to dry, and printing may become impossible.*

3. Disconnect all cables such as the power cord and USB cable.
4. Remove all of the paper from the printer.
5. Make sure there are no originals on the printer.

### Appendix

6. Open the scanner unit with the document cover closed. Secure the print head to the case with tape.

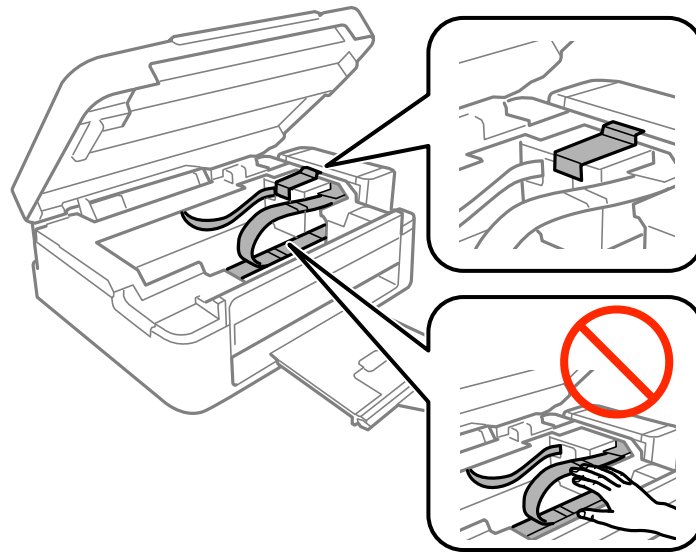

7. Close the scanner unit.

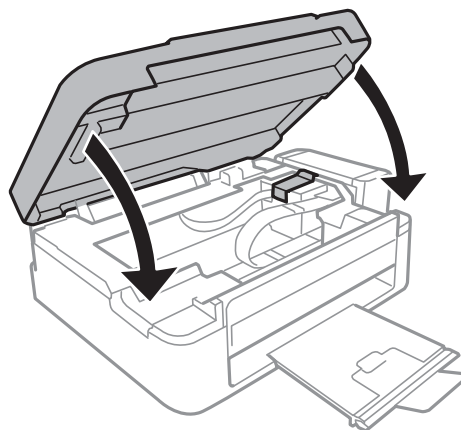

8. Prepare to pack the printer as shown below.

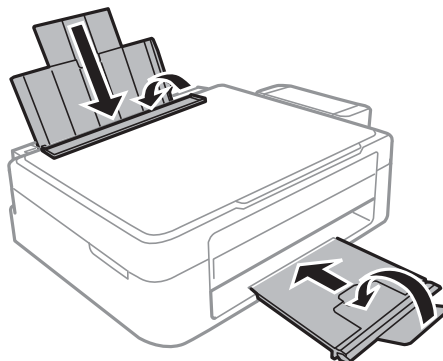

## Appendix

- Unhook the ink tank unit from the printer and lay it down, and then make sure to install the cap onto the ink tank securely.

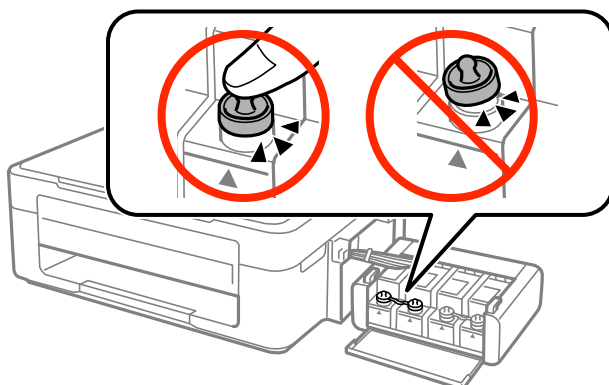

- Hook the ink tank unit onto the printer.
- Pack the printer in its box using the protective materials to prevent the ink tank from being unhooked. When you use the printer again, make sure you remove the tape securing the print head. If print quality has declined the next time you print, clean and align the print head.

### Related Information

- ➔ [“Part Names and Functions” on page 10](#)
- ➔ [“Checking and Cleaning the Print Head” on page 50](#)
- ➔ [“Aligning the Print Head” on page 53](#)

---

## Where to Get Help

### Technical Support Web Site

If you need further help, visit the Epson support website shown below. Select your country or region and go to the support section of your local Epson website. The latest drivers, FAQs, manuals, or other downloadables are also available from the site.

<http://support.epson.net/>

<http://www.epson.eu/Support> (Europe)

If your Epson product is not operating properly and you cannot solve the problem, contact Epson support services for assistance.

### Contacting Epson Support

#### Before Contacting Epson

If your Epson product is not operating properly and you cannot solve the problem using the troubleshooting information in your product manuals, contact Epson support services for assistance. If Epson support for your area is not listed below, contact the dealer where you purchased your product.

Epson support will be able to help you much more quickly if you give them the following information:

## Appendix

- Product serial number  
(The serial number label is usually on the back of the product.)
- Product model
- Product software version  
(Click **About**, **Version Info**, or a similar button in the product software.)
- Brand and model of your computer
- Your computer operating system name and version
- Names and versions of the software applications you normally use with your product

**Note:**

*Depending on the product, the dial list data for fax and/or network settings may be stored in the product's memory. Due to breakdown or repair of a product, data and/or settings may be lost. Epson shall not be responsible for the loss of any data, for backing up or recovering data and/or settings even during a warranty period. We recommend that you make your own backup data or take notes.*

## Help for Users in Europe

Check your Pan-European Warranty Document for information on how to contact Epson support.

## Help for Users in Taiwan

Contacts for information, support, and services are:

### World Wide Web

<http://www.epson.com.tw>

Information on product specifications, drivers for download, and products enquiry are available.

### Epson HelpDesk (Phone: +02-80242008)

Our HelpDesk team can help you with the following over the phone:

- Sales enquiries and product information
- Product usage questions or problems
- Enquiries on repair service and warranty

### Repair service center:

Telephone number	Fax number	Address
02-23416969	02-23417070	No.20, Beiping E. Rd., Zhongzheng Dist., Taipei City 100, Taiwan
02-27491234	02-27495955	1F., No.16, Sec. 5, Nanjing E. Rd., Songshan Dist., Taipei City 105, Taiwan
02-32340688	02-32340699	No.1, Ln. 359, Sec. 2, Zhongshan Rd., Zhonghe City, Taipei County 235, Taiwan
039-605007	039-600969	No.342-1, Guangrong Rd., Luodong Township, Yilan County 265, Taiwan
038-312966	038-312977	No.87, Guolian 2nd Rd., Hualien City, Hualien County 970, Taiwan



## Appendix

Telephone number	Fax number	Address
03-4393119	03-4396589	5F., No.2, Nandong Rd., Pingzhen City, Taoyuan County 32455, Taiwan
03-5325077	03-5320092	1F., No.9, Ln. 379, Sec. 1, Jingguo Rd., North Dist., Hsinchu City 300, Taiwan
04-23011502	04-23011503	3F., No.30, Dahe Rd., West Dist., Taichung City 40341, Taiwan
04-2338-0879	04-2338-6639	No.209, Xinxing Rd., Wuri Dist., Taichung City 414, Taiwan
05-2784222	05-2784555	No.463, Zhongxiao Rd., East Dist., Chiayi City 600, Taiwan
06-2221666	06-2112555	No.141, Gongyuan N. Rd., North Dist., Tainan City 704, Taiwan
07-5520918	07-5540926	1F., No.337, Minghua Rd., Gushan Dist., Kaohsiung City 804, Taiwan
07-3222445	07-3218085	No.51, Shandong St., Sanmin Dist., Kaohsiung City 807, Taiwan
08-7344771	08-7344802	1F., No.113, Shengli Rd., Pingtung City, Pingtung County 900, Taiwan

## Help for Users in Singapore

Sources of information, support, and services available from Epson Singapore are:

### World Wide Web

<http://www.epson.com.sg>

Information on product specifications, drivers for download, Frequently Asked Questions (FAQ), Sales Enquiries, and Technical Support via e-mail are available.

### Epson HelpDesk (Phone: (65) 6586 3111)

Our HelpDesk team can help you with the following over the phone:

- Sales enquiries and product information
- Product usage questions or problems
- Enquiries on repair service and warranty

## Help for Users in Thailand

Contacts for information, support, and services are:

### World Wide Web

<http://www.epson.co.th>

Information on product specifications, drivers for download, Frequently Asked Questions (FAQ), and e-mail are available.

### Epson Hotline (Phone: (66) 2685-9899)

Our Hotline team can help you with the following over the phone:

- Sales enquiries and product information

## Appendix

- Product usage questions or problems
- Enquiries on repair service and warranty

### Help for Users in Vietnam

Contacts for information, support, and services are:

Epson Hotline (Phone): 84-8-823-9239

Service Center: 80 Truong Dinh Street, District 1, Hochiminh City, Vietnam.

### Help for Users in Indonesia

Contacts for information, support, and services are:

#### World Wide Web

<http://www.epson.co.id>

- Information on product specifications, drivers for download
- Frequently Asked Questions (FAQ), Sales Enquiries, questions through e-mail

#### Epson Hotline

- Sales enquiries and product information
- Technical support
  - Phone: (62) 21-572 4350
  - Fax: (62) 21-572 4357

#### Epson Service Center

Jakarta	Mangga Dua Mall 3rd floor No 3A/B Jl. Arteri Mangga Dua, Jakarta	Phone/Fax: (62) 21-62301104
Bandung	Lippo Center 8th floor Jl. Gatot Subroto No.2 Bandung	Phone/Fax: (62) 22-7303766
Surabaya	Hitech Mall It IIB No. 12 Jl. Kusuma Bangsa 116-118 Surabaya	Phone: (62) 31-5355035 Fax: (62)31-5477837
Yogyakarta	Hotel Natour Garuda Jl. Malioboro No. 60 Yogyakarta	Phone: (62) 274-565478
Medan	Wisma HSBC 4th floor Jl. Diponegoro No. 11 Medan	Phone/Fax: (62) 61-4516173

## Appendix

Makassar	MTC Karebosi Lt. III Kav. P7-8 Jl. Ahmad Yani No.49 Makassar	Phone: (62)411-350147/411-350148
----------	--	----------------------------------

### Help for Users in Hong Kong

To obtain technical support as well as other after-sales services, users are welcome to contact Epson Hong Kong Limited.

#### Internet Home Page

Epson Hong Kong has established a local home page in both Chinese and English on the Internet to provide users with the following information:

- Product information
- Answers to Frequently Asked Questions (FAQs)
- Latest versions of Epson product drivers

Users can access our World Wide Web home page at:

<http://www.epson.com.hk>

#### Technical Support Hotline

You can also contact our technical staff at the following telephone and fax numbers:

Phone: (852) 2827-8911

Fax: (852) 2827-4383

### Help for Users in Malaysia

Contacts for information, support, and services are:

#### World Wide Web

<http://www.epson.com.my>

- Information on product specifications, drivers for download
- Frequently Asked Questions (FAQ), Sales Enquiries, questions through e-mail

#### Epson Trading (M) Sdn. Bhd.

Head Office:

Phone: 603-56288288

Fax: 603-56288388/399

Epson Helpdesk:

- Sales enquiries and product information (Infoline)  
Phone: 603-56288222
- Enquiries on repair services & warranty, product usage and technical support (Techline)  
Phone: 603-56288333

## Appendix

### Help for Users in India

Contacts for information, support, and services are:

#### World Wide Web

<http://www.epson.co.in>

Information on product specifications, drivers for download, and products enquiry are available.

#### Epson India Head Office - Bangalore

Phone: 080-30515000

Fax: 30515005

#### Epson India Regional Offices:

Location	Telephone number	Fax number
Mumbai	022-28261515/16/17	022-28257287
Delhi	011-30615000	011-30615005
Chennai	044-30277500	044-30277575
Kolkata	033-22831589/90	033-22831591
Hyderabad	040-66331738/39	040-66328633
Cochin	0484-2357950	0484-2357950
Coimbatore	0422-2380002	NA
Pune	020-30286000/30286001/30286002	020-30286000
Ahmedabad	079-26407176/77	079-26407347

#### Helpline

For Service, Product info or to order a cartridge - 18004250011 (9AM - 9PM) - This is a Toll-free number.

For Service (CDMA & Mobile Users) - 3900 1600 (9AM - 6PM) Prefix local STD code

### Help for Users in the Philippines

To obtain technical support as well as other after sales services, users are welcome to contact the Epson Philippines Corporation at the telephone and fax numbers and e-mail address below:

Trunk Line: (63-2) 706 2609

Fax: (63-2) 706 2665

Helpdesk Direct Line: (63-2) 706 2625

E-mail: [epchelpdesk@epc.epson.com.ph](mailto:epchelpdesk@epc.epson.com.ph)

#### World Wide Web

<http://www.epson.com.ph>

## Appendix

Information on product specifications, drivers for download, Frequently Asked Questions (FAQ), and E-mail Enquiries are available.

### **Toll-Free No. 1800-1069-EPSON (37766)**

Our Hotline team can help you with the following over the phone:

- Sales enquiries and product information
- Product usage questions or problems
- Enquiries on repair service and warranty