

DS-360W
User's Guide

Copyright

No part of this publication may be reproduced, stored in a retrieval system, or transmitted in any form or by any means, electronic, mechanical, photocopying, recording, or otherwise, without the prior written permission of Seiko Epson Corporation. No patent liability is assumed with respect to the use of the information contained herein. Neither is any liability assumed for damages resulting from the use of the information herein. The information contained herein is designed only for use with this Epson product. Epson is not responsible for any use of this information as applied to other products.

Neither Seiko Epson Corporation nor its affiliates shall be liable to the purchaser of this product or third parties for damages, losses, costs, or expenses incurred by the purchaser or third parties as a result of accident, misuse, or abuse of this product or unauthorized modifications, repairs, or alterations to this product, or (excluding the U.S.) failure to strictly comply with Seiko Epson Corporation's operating and maintenance instructions.

Seiko Epson Corporation and its affiliates shall not be liable for any damages or problems arising from the use of any options or any consumable products other than those designated as Original Epson Products or Epson Approved Products by Seiko Epson Corporation.

Seiko Epson Corporation shall not be held liable for any damage resulting from electromagnetic interference that occurs from the use of any interface cables other than those designated as Epson Approved Products by Seiko Epson Corporation.

© 2021 Seiko Epson Corporation. All rights reserved.

The contents of this manual and the specifications of this product are subject to change without notice.

Trademarks

- ❑ EPSON® is a registered trademark, and EPSON EXCEED YOUR VISION or EXCEED YOUR VISION is a trademark of the Seiko Epson Corporation.
- ❑ Microsoft®, Windows®, Windows Server®, and Windows Vista® are either registered trademarks or trademarks of Microsoft Corporation in the United States and/or other countries.
- ❑ Apple®, Mac OS®, and OS X® are trademarks of Apple Inc., registered in the U.S. and other countries.
- ❑ Adobe®, Adobe Reader®, and Acrobat® are registered trademarks of Adobe Systems Incorporated.
- ❑ Intel® is a registered trademark of Intel Corporation.
- ❑ Wi-Fi®, Wi-Fi Alliance®, and Wi-Fi Protected Access® (WPA) are registered trademarks of the Wi-Fi Alliance. Wi-Fi Protected Setup™, and WPA2™ are trademarks of the Wi-Fi Alliance.
- ❑ The SuperSpeed USB Trident Logo is a registered trademark of USB Implementers Forum, Inc.
- ❑ Epson Scan 2 Software is based in part on the work of the Independent JPEG Group.
- ❑ libtiff

Copyright © 1988-1997 Sam Leffler

Copyright © 1991-1997 Silicon Graphics, Inc.

Permission to use, copy, modify, distribute, and sell this software and its documentation for any purpose is hereby granted without fee, provided that (i) the above copyright notices and this permission notice appear in all copies of the software and related documentation, and (ii) the names of Sam Leffler and Silicon Graphics may not be used in any advertising or publicity relating to the software without the specific, prior written permission of Sam Leffler and Silicon Graphics.

THE SOFTWARE IS PROVIDED "AS-IS" AND WITHOUT WARRANTY OF ANY KIND, EXPRESS, IMPLIED OR OTHERWISE, INCLUDING WITHOUT LIMITATION, ANY WARRANTY OF MERCHANTABILITY OR FITNESS FOR A PARTICULAR PURPOSE.

IN NO EVENT SHALL SAM LEFFLER OR SILICON GRAPHICS BE LIABLE FOR ANY SPECIAL, INCIDENTAL, INDIRECT OR CONSEQUENTIAL DAMAGES OF ANY KIND, OR ANY DAMAGES WHATSOEVER RESULTING FROM LOSS OF USE, DATA OR PROFITS, WHETHER OR NOT ADVISED OF THE POSSIBILITY OF DAMAGE, AND ON ANY THEORY OF LIABILITY, ARISING OUT OF OR IN CONNECTION WITH THE USE OR PERFORMANCE OF THIS SOFTWARE.

- ❑ General Notice: Other product names used herein are for identification purposes only and may be trademarks of their respective owners. Epson disclaims any and all rights in those marks.

Contents

Copyright

Trademarks

About This Manual

Introduction to the Manuals.	7
Marks and Symbols.	7
Descriptions Used in this Manual.	7
Operating System References.	8

Important Instructions

Safety Instructions.	9
Safety Instructions for the Battery.	10
Disposing of European Scanner Models.	10
Restrictions on Copying.	11

Scanner Basics

Part Names and Functions.	12
Buttons and Lights on the Control Panel.	15
Buttons and Lights.	15
Error Indicators.	16
Information on Applications.	17
Epson Scan 2.	18
Document Capture Pro / Document Capture.	18
Presto! BizCard.	18
EPSON Software Updater.	18
Epson DocumentScan.	18
EpsonNet Config.	18
Information on Consumables.	19
Pickup Roller Codes.	19
Separation Pad Codes.	19

Using the Scanner on the Battery

Notice on Using the Battery.	21
Charging the Battery.	21
Battery Charging Precautions.	21
Charging the Battery by Connecting to an AC Adapter.	22
Charging the Battery with a USB Connection.	22

Specifications of Originals and Placing Originals

Specifications of Originals for Scanning from the ADF.	24
General Specifications for Originals being Scanned.	24
Types of Originals that Require Attention.	26
Types of Originals that Must Not be Scanned.	27
Specifications for Plastic Cards for Scanning from the Card Slot.	28
Types of Cards that Require Attention.	28
Placing Standard Size Originals in the ADF.	28
Specifications of Standard Size Originals.	28
Placing Standard Size Originals.	30
Placing Long Paper in the ADF.	33
Specifications of Long Paper.	33
Placing Long Paper.	34
Placing Receipts in the ADF.	38
Specifications for Receipts.	38
Placing Receipts.	38
Placing Thick Originals in the ADF.	42
Specifications for Thick Originals.	42
Placing Thick Originals.	42
Placing Envelopes in the ADF.	45
Specifications of Envelopes.	45
Placing Envelopes.	46
Placing Plastic Cards in the Card Slot.	48
Specifications for Plastic Cards for Scanning from the Card Slot.	48
Types of Cards that Require Attention.	49
Placing Plastic Cards.	49

Basic Scanning

Scanning Using Epson Scan 2.	52
Required Settings for Special Originals in Epson Scan 2.	55
Setting a Resolution That Suits the Scanning Purpose.	55
Scanning Using Document Capture Pro (Windows).	56
Scanning Using Document Capture (Mac OS X).	59
Scanning Using a Scanner Button.	61

Contents

Advanced Scanning

Scanning Different Sizes or Types of Originals	
One by One (Automatic Feeding Mode)	63
Creating Scanned Images to Suit Your Needs.	64
Image Adjustment Features.	64
Editing Scanned Pages Using Epson Scan 2.	71
Saving as a Searchable PDF.	71
Saving as an Office Format File (for Windows Only).	72
Various Types of Saving and Transferring.	74
Sorting and Saving Scanned Images into a Separate Folder (for Windows Only).	74
Scanning to a Cloud Service.	74
Uploading to an FTP Server.	76
Attaching Scanned Images to an Email.	76
Printing Scanned Images.	77
Scanning Using Specified Scanning Settings (Job).	77
Setting a Job.	78
Assigning a Job to the Scanner Button.	78
Scanning Business Cards Using Presto! BizCard.	79

Network Settings

Network Connection Types.	81
Wi-Fi Connection.	81
AP Mode Connection.	81
Connecting to a Computer.	82
Connecting to a Smart Device.	84
Making Wi-Fi Settings from the Control Panel.	84
Making Wi-Fi Settings by Push Button Setup.	84
Making Wi-Fi Settings by PIN Code Setup (WPS).	86
Making Wi-Fi Settings by Using EpsonNet Config.	89
Making AP Mode Settings.	93
Making AP Mode Settings Using Push Button.	95
Checking the Network Status Using Network Light.	96
Replacing or Adding New Access Points.	97
Changing the Connection Method to a Computer.	97
Restoring the Network Settings from the Control Panel.	98

Maintenance

Cleaning Outside the Scanner.	100
Cleaning Inside the Scanner.	100
Replacing Consumables.	106
Replacing the Pickup Roller.	106

Replacing the Separation Pad.	109
Resetting the Number of Scans.	111
Energy Saving.	112
Carrying the scanner.	113
Updating Applications and Firmware.	114

Solving Problems

Scanner Problems.	116
Scanner Lights Indicate an Error.	116
The Scanner Does Not Turn On.	116
The Scanner Turns Off when Running on the Battery.	117
The Scanner Does not Turn Off when Running on the Battery.	117
Problems Starting Scanning.	117
Cannot Start Epson Scan 2.	117
Pressing a Scanner Button Does Not Start the Correct Application.	118
Paper Feeding Problems.	118
Multiple Originals Are Fed.	118
Removing Jammed Originals from the Scanner.	119
The Originals Get Dirty.	121
Scanning Takes a Long Time.	121
Scanned Image Problems.	121
Scanned Text or Images are Blurred.	121
Straight Lines Appear when Scanning from ADF.	121
The Image Quality is Rough.	122
Expanding or Contracting the Scanned Image.	122
Offset Appears in the Background of Images.	122
Moiré Patterns (Web-Like Shadows) Appear.	123
The Edge of the Original is Not Scanned when Automatically Detecting the Size of the Original.	123
When Scanning a Plastic Card, the Image is Curved, Tilted, Incomplete, or Contains Lines.	123
Text is Not Recognized Correctly when Saving as a Searchable PDF.	124
Cannot Solve Problems in the Scanned Image.	124
Network Problems.	125
When You Cannot Make Network Settings.	125
The Scanner Suddenly Cannot Scan over a Network Connection.	128
Suddenly the Scanner became Unable to Scan - USB.	128
Uninstalling and Installing Applications.	128
Uninstalling Your Applications.	128
Installing Your Applications.	130

Technical Specifications

General Scanner Specifications.	131
Wi-Fi Specifications.	132
Dimensional Specifications.	132
Electrical Specifications.	132
Scanner Electrical Specifications.	132
AC Adapter Electrical Specifications.	133
Battery Specifications.	133
Environmental Specifications.	134
System Requirements.	134

Standards and Approvals

Standards and Approvals for U.S. Models.	135
Standards and Approvals for European Models. . .	135
Standards and Approvals for Australian Models. . .	136

Where to Get Help

Technical Support Web Site.	137
Contacting Epson Support.	137
Before Contacting Epson.	137
Help for Users in Europe.	137
Help for Users in Taiwan.	138
Help for Users in Australia.	138
Help for Users in Singapore.	139
Help for Users in Thailand.	139
Help for Users in Vietnam.	139
Help for Users in Indonesia.	140
Help for Users in Hong Kong.	143
Help for Users in Malaysia.	143
Help for Users in India.	144
Help for Users in the Philippines.	144

About This Manual

Introduction to the Manuals

The latest versions of the following manuals are available from the Epson support website.

<http://www.epson.eu/support> (Europe)

<http://support.epson.net/> (outside Europe)

Setup Guide (paper manual)

Provides you with information on setting up the product and installing the application.

User's Guide (digital manual)

Provides instructions on using the product, maintenance, and solving problems.

As well as the manuals above, see the help included in the various Epson applications.

Marks and Symbols



Caution:

Instructions that must be followed carefully to avoid bodily injury.



Important:

Instructions that must be observed to avoid damage to your equipment.

Note:

Provides complementary and reference information.

Related Information

➔ Links to related sections.

Descriptions Used in this Manual

- Screenshots for the applications are from Windows 10 or Mac OS X v10.10.x. The content displayed on the screens varies depending on the model and situation.
- Illustrations used in this manual are for reference only. Although they may differ slightly from the actual product, the operating methods are the same.

Operating System References

Windows

In this manual, terms such as "Windows 10", "Windows 8.1", "Windows 8", "Windows 7", "Windows Vista", "Windows XP", "Windows Server 2012 R2", "Windows Server 2012", "Windows Server 2008 R2", "Windows Server 2008", "Windows Server 2003 R2", and "Windows Server 2003" refer to the following operating systems. Additionally, "Windows" is used to refer to all versions.

- Microsoft® Windows® 10 operating system
- Microsoft® Windows® 8.1 operating system
- Microsoft® Windows® 8 operating system
- Microsoft® Windows® 7 operating system
- Microsoft® Windows Vista® operating system
- Microsoft® Windows® XP operating system Service Pack 3
- Microsoft® Windows® XP Professional x64 Edition operating system Service Pack 2
- Microsoft® Windows Server® 2012 R2 operating system
- Microsoft® Windows Server® 2012 operating system
- Microsoft® Windows Server® 2008 R2 operating system
- Microsoft® Windows Server® 2008 operating system
- Microsoft® Windows Server® 2003 R2 operating system
- Microsoft® Windows Server® 2003 operating system Service Pack 2

Mac OS X

In this manual, "Mac OS X v10.11.x" refers to OS X El Capitan, "Mac OS X v10.10.x" refers to OS X Yosemite, "Mac OS X v10.9.x" refers to OS X Mavericks, and "Mac OS X v10.8.x" refers to OS X Mountain Lion. Additionally, "Mac OS X" is used to refer to "Mac OS X v10.11.x", "Mac OS X v10.10.x", "Mac OS X v10.9.x", "Mac OS X v10.8.x", "Mac OS X v10.7.x", and "Mac OS X v10.6.8".

Important Instructions

Safety Instructions

Read and follow these instructions to ensure safe use of this product. Make sure you keep this manual for future reference. Also, be sure to follow all warnings and instructions marked on the product.

- ❑ Some of the symbols used on your product are to ensure safety and proper use of the product. Visit the following Web site to learn the meaning of the symbols.
<http://support.epson.net/symbols>
- ❑ Place the product on a flat, stable surface that extends beyond the base of the product in all directions. If you place the product by the wall, leave more than 10 cm between the back of the product and the wall.
- ❑ Place the product close enough to the computer for the interface cable to reach it easily. Do not place or store the product or the AC adapter outdoors, near excessive dirt or dust, water, heat sources, or in locations subject to shocks, vibrations, high temperature or humidity, direct sunlight, strong light sources, or rapid changes in temperature or humidity.
- ❑ Do not use with wet hands.
- ❑ Place the product near an electrical outlet where the adapter can be easily unplugged.
- ❑ The AC adapter cord should be placed to avoid abrasions, cuts, fraying, crimping, and kinking. Do not place objects on top of the cord and do not allow the AC adapter or the cord to be stepped on or run over. Be particularly careful to keep the cord straight at the end.
- ❑ Use only the power cord supplied with the product and do not use the cord with any other equipment. Use of other cords with this product or the use of the supplied power cord with other equipment may result in fire or electric shock.
- ❑ Use only the AC adapter and the USB cable supplied with your product. Using any other adapter or a USB cable could cause fire, electrical shock, or injury.
- ❑ The AC adapter is designed for use with the product with which it was included. Do not attempt to use it with other electronic devices unless specified.
- ❑ Use only the type of power source indicated on the AC adapter's label, and always supply power directly from a standard domestic electrical outlet with the AC adapter that meets the relevant local safety standards.
- ❑ When connecting this product to a computer or other device with a cable, ensure the correct orientation of the connectors. Each connector has only one correct orientation. Inserting a connector in the wrong orientation may damage both devices connected by the cable.
- ❑ Avoid using outlets on the same circuit as photocopiers or air control systems that regularly switch on and off.
- ❑ If you use an extension cord with the product, make sure the total ampere rating of the devices plugged into the extension cord does not exceed the cord's ampere rating. Also, make sure the total ampere rating of all devices plugged into the wall outlet does not exceed the wall outlet's ampere rating.
- ❑ Never disassemble, modify, or attempt to repair the AC adapter or product by yourself except as specifically explained in the product's guides.
- ❑ Do not insert objects into any opening as they may touch dangerous voltage points or short out parts. Beware of electrical shock hazards.
- ❑ If damage occurs to the plug, replace the cord set or consult a qualified electrician. If there are fuses in the plug, make sure you replace them with fuses of the correct size and rating.

Important Instructions

- ❑ Unplug the product and the AC adapter, and refer servicing to qualified service personnel under the following conditions: The AC adapter or plug is damaged; liquid has entered the product or the AC adapter; the product or the AC adapter has been dropped or the case has been damaged; the product or the AC adapter does not operate normally or exhibits a distinct change in performance. (Do not adjust controls that are not covered by the operating instructions.)
- ❑ Unplug the product and the AC adapter before cleaning. Clean with a damp cloth only. Do not use liquid or aerosol cleaners except as specifically explained in the product's guides.
- ❑ If you are not going to use the product for a long period, be sure to unplug the AC adapter from the electrical outlet.
- ❑ After replacing consumable parts, dispose of them correctly following the rules of your local authority. Do not disassemble them.
- ❑ Keep this product at least 22 cm away from cardiac pacemakers. Radio waves from this product may adversely affect the operation of cardiac pacemakers.
- ❑ Do not use this product inside medical facilities or near medical equipment. Radio waves from this product may adversely affect the operation of electrical medical equipment.
- ❑ Do not use this product near automatically controlled devices such as automatic doors or fire alarms. Radio waves from this product may adversely affect these devices, and could lead to accidents due to malfunction.

Safety Instructions for the Battery

- ❑ If the battery is not fully charged within the specified time, stop charging. Otherwise, the battery could become hot, emit smoke, rupture, or catch fire.
- ❑ Do not place the product in a microwave oven or a high-pressure container. Otherwise, the battery could become hot, emit smoke, rupture, or catch fire.
- ❑ If liquid leaks from the product, or the product emits a bad odour, move the product away from flammable objects immediately. If it is not moved, electrolytes leaking from the battery become hot, emit smoke, rupture, or catch fire.
- ❑ If battery acid gets in your eyes, immediately rinse your eyes thoroughly with fresh water without rubbing them, and then see a doctor immediately. Otherwise, permanent eye damage could result.
- ❑ If battery acid gets on your skin, immediately rinse the affected area thoroughly with water, and then see a doctor immediately.
- ❑ Do not drop or throw the product or subject it to strong shocks. Otherwise, the battery could leak or the protection circuit in the battery could be damaged. As a result, the battery could become hot, emit smoke, rupture, or catch fire.
- ❑ Do not use or leave the product in a hot location (more than 60°C), such as near a fire or a heater. Otherwise, the plastic separator could melt and the individual cells could short-circuit. As a result, the battery could become hot, emit smoke, rupture, or catch fire.
- ❑ Do not use the product if it is leaking or damaged in any way. Otherwise, the battery could become hot, emit smoke, rupture, or catch fire.
- ❑ Do not leave the product in a vehicle. Otherwise, the battery could overheat.

Disposing of European Scanner Models

There is a battery in the scanner.

Important Instructions

The crossed out wheeled bin label that can be found on your product indicates that this product and incorporated batteries should not be disposed of in the normal household waste stream. To prevent possible harm to the environment or human health please separate this product and its batteries from other waste streams to ensure that it can be recycled in an environmentally sound manner. For more details on available collection facilities please contact your local government office or the retailer where you purchased this product. Use of the chemical symbols Pb, Cd or Hg indicates if these metals are used in the battery.

This information only applies to customers in the European Union, according to Directive 2006/66/EC OF THE EUROPEAN PARLIAMENT AND OF THE COUNCIL OF 6 September 2006 on batteries and accumulators and waste batteries and accumulators and repealing Directive 91/157/EEC and legislation transposing and implementing it into the various national legal systems, and to customers in countries in Europe, Middle East and Africa (EMEA) where they have implemented equivalent regulations.

For other countries, please contact your local government to investigate the possibility of recycling your product.



Restrictions on Copying

Observe the following restrictions to ensure the responsible and legal use of your product.

Copying of the following items is prohibited by law:

- Bank bills, coins, government-issued marketable securities, government bond securities, and municipal securities
- Unused postage stamps, pre-stamped postcards, and other official postal items bearing valid postage
- Government-issued revenue stamps, and securities issued according to legal procedure

Exercise caution when copying the following items:

- Private marketable securities (stock certificates, negotiable notes, checks, etc.), monthly passes, concession tickets, etc.
- Passports, driver's licenses, warrants of fitness, road passes, food stamps, tickets, etc.

Note:

Copying these items may also be prohibited by law.

Responsible use of copyrighted materials:

Products can be misused by improperly copying copyrighted materials. Unless acting on the advice of a knowledgeable attorney, be responsible and respectful by obtaining the permission of the copyright holder before copying published material.

Scanner Basics

Part Names and Functions



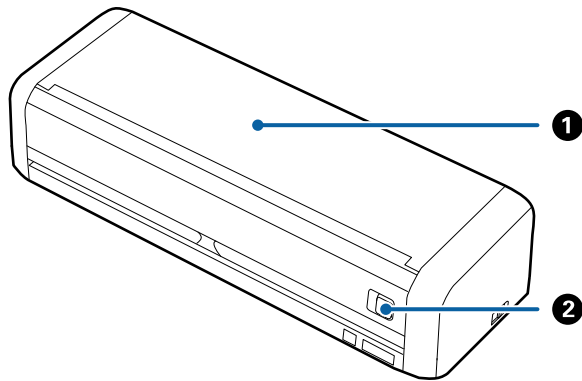

Front

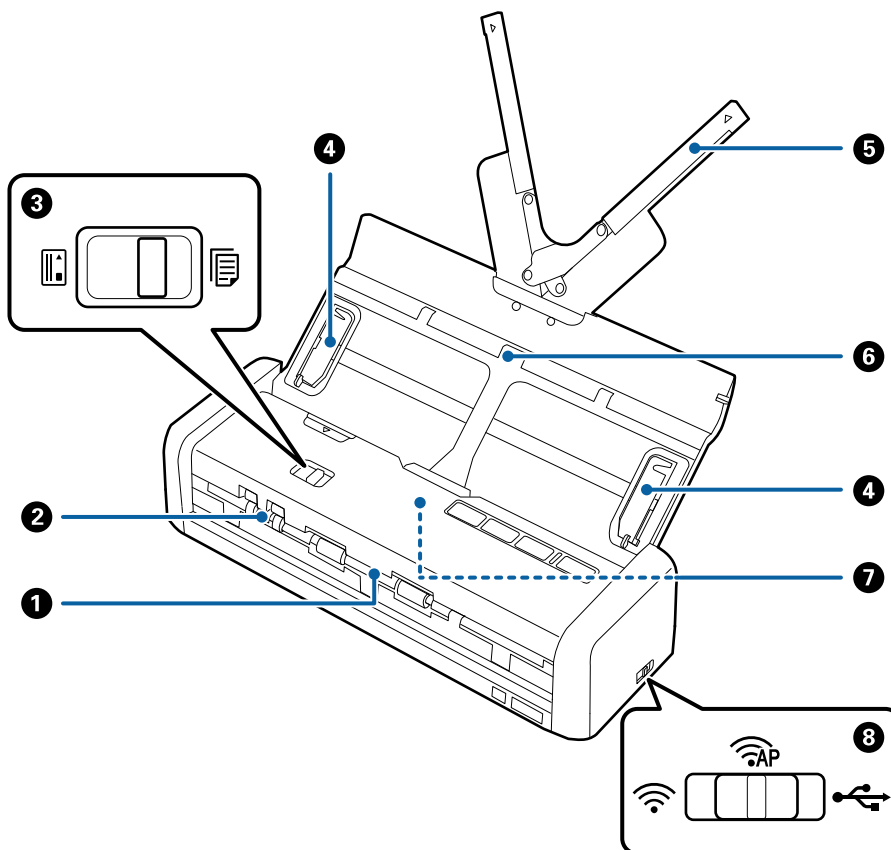

1	Input tray	Slide the input tray open lever to the left, and then raise the input tray to open it.
2	Input tray open lever	



Scanner Basics

①	Output slot	Ejects scanned originals.		
②	Card slot	Loads plastic cards. When you insert a plastic card a little way into the card slot, the card is automatically moved to the starting position.		
③	Feed selector	Sets the feed selector to scan plastic cards or other originals.		
			ADF (scan)	Scans originals using the ADF
			Card (scan)	Scans plastic cards using the card slot
④	Edge guides	Feeds originals straight into the scanner. Slide to the edges of the originals.		
⑤	Input tray extension	Loads originals. Pull out the tray extension if originals are too big for the input tray. This prevents paper from curling and causing paper jams. Do not load a plastic card in the input tray. Insert it into the card slot.		
⑥	Input tray			
⑦	ADF (Automatic Document Feeder)	Feeds loaded originals automatically		
⑧	Connection mode switch	Selects the interface to connect to the scanner. To set the interface, turn off the scanner, set the connection mode switch, and then turn on the scanner.		
			USB mode	Connects with a USB cable
			Wi-Fi mode	Makes Wi-Fi settings through the access point
			AP mode	Makes Wi-Fi settings in AP mode without the access point

Back

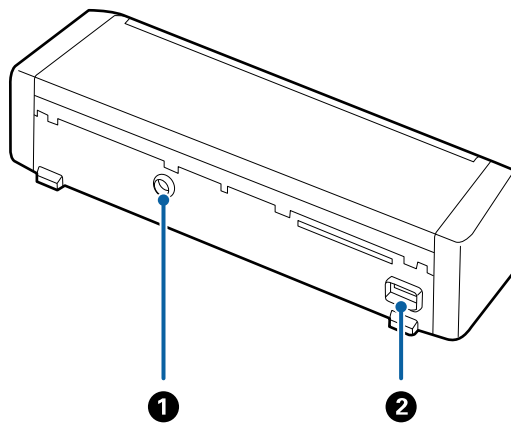

①	DC inlet	Connects the AC adapter.
②	USB port	Connects a USB cable.

Scanner Basics

Inside

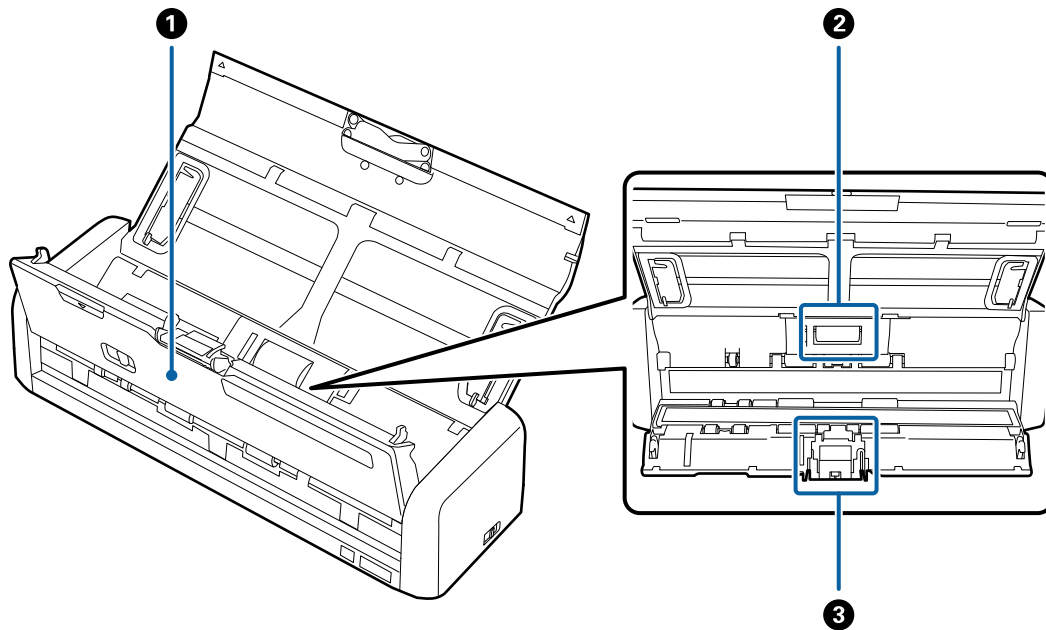

<p>❶</p>	<p>Scanner cover</p>	<p>Pull the edge of the scanner cover firmly at the ▼ mark to open it when cleaning inside the scanner and removing jammed paper.</p>
<p>❷</p>	<p>Pickup roller</p>	<p>Feeds originals. This needs to be replaced when the number of scans exceeds the service number of papers.</p>
<p>❸</p>	<p>Separation pad</p>	<p>Feeds originals separately one by one. This needs to be replaced when the number of scans exceeds the service number of papers.</p>

Related Information

➔ [“Cleaning Inside the Scanner” on page 100](#)

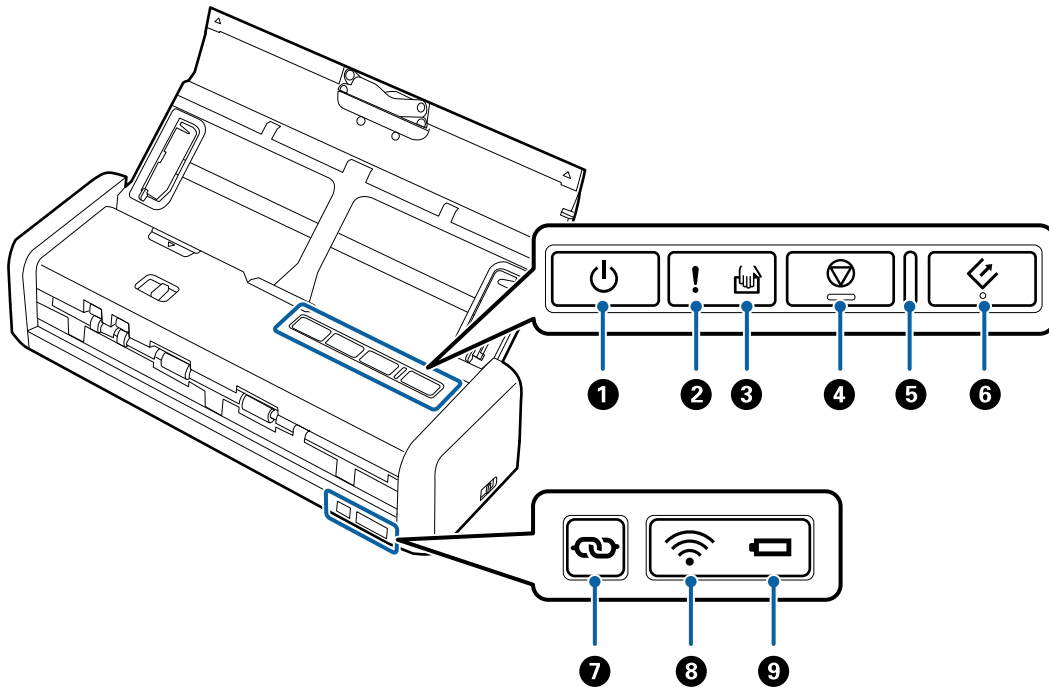

Buttons and Lights on the Control Panel

Buttons and Lights



1		Power button	Turns the scanner on or off.	
2		Error light	An error has occurred. See "Light Error Indicators" for more details.	
3		Automatic Feeding Mode light	The scanner is in Automatic Feeding Mode. Scanning starts when an original is placed in the input tray.	
4		Stop button	<input type="checkbox"/> Cancels scanning. <input type="checkbox"/> Finishes Automatic Feeding Mode.	
5	-	Ready light	On	The scanner is ready to be used. When originals are loaded in the ADF, the light becomes brighter.
			Flashing	The scanner is scanning, waiting to scan, processing, or sleeping.
			Off	The scanner cannot be used because the power is off or an error has occurred.
6		Start button	<input type="checkbox"/> Starts scanning. <input type="checkbox"/> Press this when cleaning the inside of the scanner.	
7		Wi-Fi connect button	Hold down the button for more than three seconds to connect to a Wi-Fi network while the connection mode switch is set to Wi-Fi or AP mode. See the chapter "Network Settings" for more details.	

Scanner Basics





8		Wi-Fi light	Blue indicates that the scanner is connected to a wireless (Wi-Fi) network.	
9		Battery light	On (blue)	There is enough charge left in the battery.
			Flashing (blue)	Starts flashing when the amount of charge in the battery is low. Flashes faster when the amount of charge is very low. Plug in the AC adapter before the battery runs out.
			On (orange)	The battery is charging. When charging is complete, the light turns blue.
			Flashing fast (orange)	Battery charging has stopped, or an error has occurred. See "Error Indicators" if the light does not turn on.

Related Information



- ➔ ["Network Settings" on page 81](#)
- ➔ ["Placing Plastic Cards" on page 49](#)
- ➔ ["Cleaning Inside the Scanner" on page 100](#)
- ➔ ["Error Indicators" on page 16](#)
- ➔ ["Using the Scanner on the Battery" on page 21](#)

Error Indicators

Scanner errors

Indicators	Situation	Solutions
 On Ready light Flashing	A paper jam or double feed has occurred.	Open the scanner cover, and then remove jammed originals. Close the cover to release the error. Load the originals again.
	The scanner cover is opened.	Close the scanner cover.
 Flashing Ready light Flashing Flashing simultaneously	A fatal error has occurred while using the scanner with a USB cable.	Turn the power off and on again. If the error continues to occur, contact your local dealer.
 Flashing Ready light Flashing  Flashing Flashing simultaneously	A fatal error has occurred while using the scanner with Wi-Fi.	





Scanner Basics

Indicators	Situation	Solutions
 On  On  On	The scanner has started in recovery mode because the firmware update failed.	<p>Follow the steps below to try to update the firmware again.</p> <ol style="list-style-type: none"> 1. Make sure that the AC adapter is connected to the scanner. 2. Connect the computer and the scanner with a USB cable. (During recovery mode, you cannot update the firmware over a network connection.) 3. Visit your local Epson website for further instructions.

Battery charging errors

Indicators	Situation	Solutions
 Flashing fast (orange)	Battery charging has been stopped because it became too hot.	Charge the battery within the guaranteed charging temperature range (8 to 35 °C (46 to 95 °F)).
	The battery cannot be fully charged even if it within the guaranteed temperature range (8 to 35 °C (46 to 95 °F)). It may be damaged or has reached the end of its service life.	Contact Epson support to replace the battery.

Network connection errors

Indicators	Situation	Solutions
 On  Flashing	An access point settings error has occurred.	Restart the scanner and access point, move them closer together, and then make network settings again.
 Flashing  Flashing Flashing simultaneously	An access point settings error has occurred (a security error).	

Related Information

- ➔ [“Removing Jammed Originals from the Scanner” on page 119](#)
- ➔ [“Making Wi-Fi Settings from the Control Panel” on page 84](#)
- ➔ [“Network Problems” on page 125](#)

Information on Applications

This section introduces the software products available for your scanner. The latest software can be installed at the Epson Web site.

Epson Scan 2

Epson Scan 2 is a driver for controlling your scanner, enabling a variety of scan settings. This also allows you to start either as a standalone application or by using TWAIN-compliant application software.

See the Epson Scan 2 help for details on using the application.

Document Capture Pro / Document Capture

This application allows you to rearrange pages or correct rotation for image data, and then save the data, send it by email, send it to a server, or send it to a cloud service. By registering frequently used scanning settings with a name such as "Job", you can scan by simply selecting "Job".

Document Capture Pro is for Windows only. For Mac OS X, use Document Capture.

See the Document Capture Pro help for details on using the application.

Presto! BizCard

Presto! BizCard by NewSoft provides a full range of contact management functions for adding business cards without typing. Use the BizCard recognition system to scan business cards, edit, and synchronize the information to the most frequently used personal database management software. You can easily save and manage your contact information.

EPSON Software Updater

EPSON Software Updater is an application that checks for new or updated applications on the internet and installs them.

You can also update the scanner's digital manual.

Note:

Windows Server operating systems are not supported.

Epson DocumentScan

Epson DocumentScan is an application that allows you to scan documents through smart devices such as smartphones and tablet devices. You can save the scanned data in smart devices or cloud services, and send by e-mail. You can download and install this app from the App Store or Google Play.

EpsonNet Config

EpsonNet Config is an application that allows you to set network interface addresses and protocols. See the operations guide for EpsonNet Config or the application's help for more details.

Information on Consumables

Pickup Roller Codes

Parts should be replaced when the number of scans exceeds the service number. You can check the latest number of scans in Epson Scan 2 Utility.



Part name	Codes	Life cycle
Pickup Roller	B12B819251 B12B819261 (China only) B12B819311 (India, Bangladesh, Bhutan, Maldives, Sri Lanka, and Nepal only)	100,000*

* This number was reached by consecutively scanning using Epson test original papers, and is a guide to the replacement cycle. The replacement cycle may vary depending on different paper types, such as paper that generates a lot of paper dust or paper with a rough surface that may shorten the life cycle.

Related Information

- ➔ [“Replacing the Pickup Roller” on page 106](#)
- ➔ [“Resetting the Number of Scans” on page 111](#)

Separation Pad Codes

Parts should be replaced when the number of scans exceeds the service number. You can check the latest number of scans in Epson Scan 2 Utility.

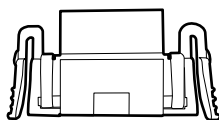

Part name	Codes	Life cycle
Separation Pad	B12B819271 B12B819281 (China only) B12B819321 (India, Bangladesh, Bhutan, Maldives, Sri Lanka, and Nepal only)	10,000*

* This number was reached by consecutively scanning using Epson test original papers, and is a guide to the replacement cycle. The replacement cycle may vary depending on different paper types, such as paper that generates a lot of paper dust or paper with a rough surface that may shorten the life cycle.

Related Information

- ➔ [“Replacing the Separation Pad” on page 109](#)
- ➔ [“Resetting the Number of Scans” on page 111](#)

Using the Scanner on the Battery

Notice on Using the Battery

- ❑ When the AC adapter is not connected and the scanner is connected by USB 2.0 or Wi-Fi to the computer, the scanner runs on the battery. If the battery becomes runs out and the battery light turns off, you cannot scan. We recommend connecting the AC adapter to the scanner when the battery lamp starts flashing.
- ❑ When the scanner is run on USB 3.0 bus power, the scanning speed may become slower when the battery is running low and the battery light starts flashing fast.

Related Information

➔ [“Buttons and Lights” on page 15](#)

Charging the Battery

Battery Charging Precautions

- ❑ At the time of purchase the battery is not fully charged. Make sure you charge the battery before you run the scanner using the battery.
- ❑ The battery slowly runs down even when you do not use the scanner. Charge the battery before you run the scanner using the battery.
- ❑ If you do not use the scanner for a long time, charge the battery using the AC adapter once every six months on a regular basis to avoid letting it run out.
- ❑ We recommend turning off the scanner when not in use to save the battery. You can also set the scanner to turn off automatically after a specified period of time.
- ❑ The battery's usable time is shorter in low temperature environments, even if you have charged the battery fully.
- ❑ You do not need to wait for the battery to run out before charging it.
- ❑ The battery may be hot right after it is charged or used; this is normal.
- ❑ The battery cannot be charged or the battery may deteriorate if you charge it in low or high temperatures. Charge the battery within the guaranteed charging temperature range (8 to 35 °C (46 to 95 °F)).
- ❑ If the  light flashes fast (orange) when the battery being charged within the guaranteed temperature range (8 to 35 °C (46 to 95 °F)) or it runs out quickly even after it has been fully charged, the battery may be malfunctioning or at the end of its service life. Contact Epson support to replace the battery.

Using the Scanner on the Battery

Charging the Battery by Connecting to an AC Adapter

1. Connect the power cord to the AC adapter, connect the AC adapter to the scanner, and then plug in the power cord.

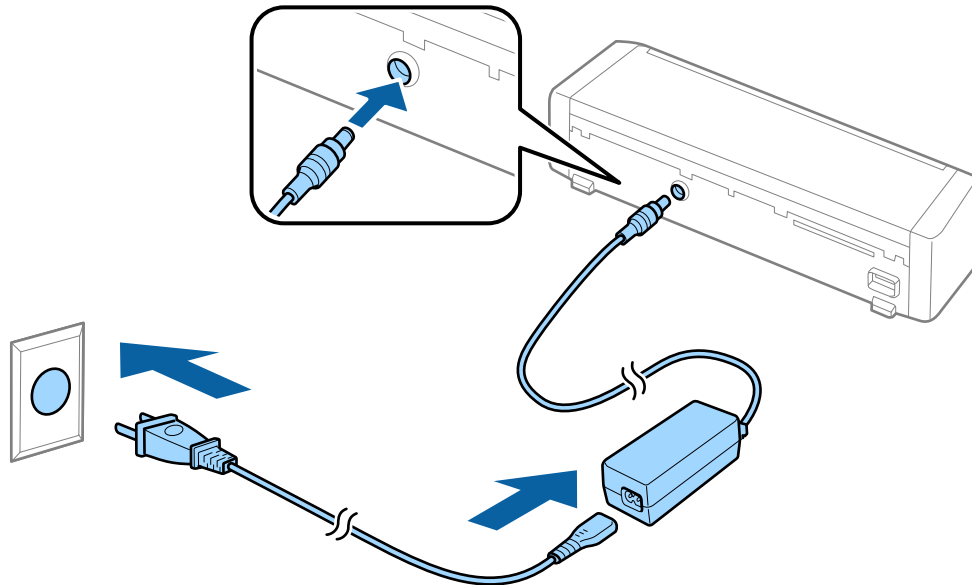

Note:

- ❑ The battery charging light turns orange when the battery is charging. When charging is complete, the light turns blue if the scanner is on, if the scanner is off the light turns off.
- ❑ It takes approximately 3 hours to fully charge the battery.

Charging the Battery with a USB Connection

You can charge the battery from a computer with a USB connection.

1. Make sure that the computer is on. Wake the computer if it is in hibernate or sleep mode.

Using the Scanner on the Battery

2. Connect the scanner to the computer using the micro USB cable.

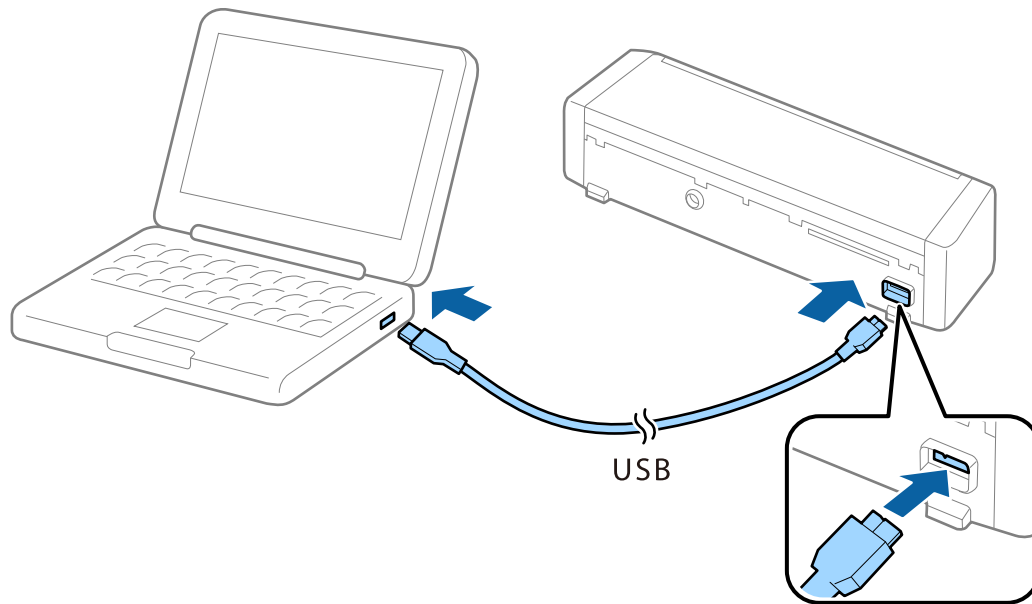

Note:

Connect the scanner directly to the computer without using a USB hub.

3. Press the  button to turn on the scanner.

Note:

- Battery charging time when the scanner is on.

USB 3.0 port: Approx. 4 hours*

USB 2.0 port: Approx. 20 hours*

* It takes much longer to charge the battery if the scanner is off.

- You can charge the battery even if the scanner is turned off. If you do not want to consume the computer's battery, disconnect the USB cable.
- Battery rated capacity: 2090 mAh (3.6 V)
- The battery charging light turns orange when the battery is charging. When charging is complete, the light turns blue if the scanner is on, if the scanner is off the light turns off.

Specifications of Originals and Placing Originals

Specifications of Originals for Scanning from the ADF

This section explains the specifications and conditions of originals that can be loaded in the ADF.

General Specifications for Originals being Scanned

Type of Original	Thickness	Size
Plain paper	51.8 to 128 g/m ²	Maximum: 215.9×1,117.6 mm (8.5×44 in.)
Fine paper	50.8×70 mm to 100×148 mm (2×2.8 in. to 3.9×5.8 in.):	Minimum: 50.8×70 mm (2.0×2.8 in.)
Recycled paper	51.8 to 230 g/m ²	The loadable size varies depending on the type of originals.
Post card		
Business card		
Envelopes		

Note:

- ❑ All originals must be flat at the leading edge.
- ❑ Make sure that curls on the leading edge of the originals are kept within the following range.
 - ① and ② must be 2 mm or less when ③ is equal to or more than 30 mm.

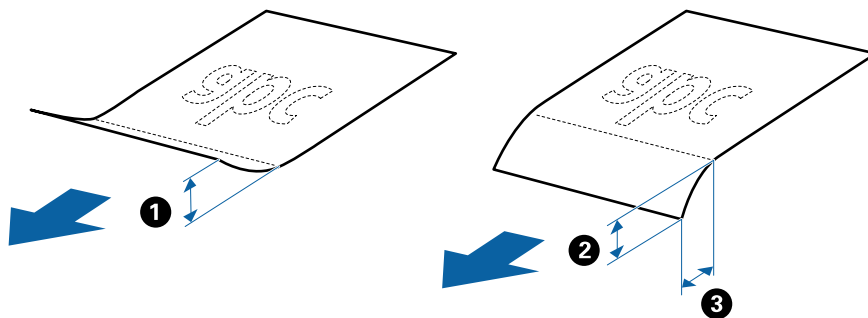

Specifications of Standard Size Originals

These are the specifications for standard size originals that you can load into the ADF.

Specifications of Originals and Placing Originals

Size	Measurement	Thickness	Paper Type	Loading Capacity *
A4	210×297 mm (8.3×11.7 in.)	51.8 to 128 g/m ²	Plain paper Fine paper Recycled paper	Thickness of the originals stack: under 2 mm (0.07 in.) 64 g/m ² : 25 sheets 80 g/m ² : 20 sheets 128 g/m ² : 12 sheets The loading capacity varies depending on the paper type.
Letter	215.9×279.4 mm (8.5×11 in.)			
Legal	215.9×355.6 mm (8.5×14 in.)			
B5	182×257 mm (7.2×10.1 in.)			
A5	148×210 mm (5.8×8.3 in.)			
B6	128×182 mm (5.0×7.2 in.)			
A6	105×148 mm (4.1×5.8 in.)			
Business Card	55×89 mm (2.1×3.4 in.)	128 to 230 g/m ²		Thickness of the originals stack: under 2mm (0.07 in.) 190 g/m ² : 8 sheets 220 g/m ² : 6 sheets
Post Cards	100×148 mm (3.9×5.8 in.)	128 to 230 g/m ²	Plain paper Fine paper Recycled paper	Thickness of the originals stack: under 2 mm (0.07 in.) 190 g/m ² : 8 sheets 220 g/m ² : 6 sheets

* You can refill the originals up to the maximum capacity during scanning.

Specifications of Long Paper

These are the specifications for long paper that you can load into the scanner.

Size	Thickness	Paper Type	Loading Capacity
Width: 50.8 to 215.9 mm (2.0 to 8.5 in.) Length: 368.3 to 1,117.6 mm (14.5 to 44 in.)	51.8 to 128 g/m ²	Plain paper Fine paper Recycled paper	1 sheet

Specifications for Receipts

These are the specifications for receipts that you can load into the scanner.

Specifications of Originals and Placing Originals

Size	Thickness	Paper Type	Loading Capacity
Maximum: 76.2×355.6 mm (3.0×14 in.) Minimum: 76.2×76.2 mm (3.0×3.0 in.)	53 to 77 g/m ²	Plain paper Fine paper Recycled paper	1 sheet*

* Receipts need to be scanned using Automatic Feeding Mode. Only one receipt should be loaded at once and you need to hold the receipt for a good quality scan.

Specifications for Thick Originals

These are the specifications for thick originals, such as business cards or post cards, that you can load into the scanner.

Size	Thickness	Loading Capacity	Loading Direction
50.8×70 mm to 100×148 mm (2×2.8 in. to 3.9×5.8 in.)	128 to 230 g/m ²	Thickness of the originals stack: under 2 mm (0.07 in.) 190 g/m ² : 8 sheets 220 g/m ² : 6 sheets	Vertical (Portrait)

Specifications of Envelopes

These are the specifications for envelopes that you can load into the scanner.

Measurement	Thickness	Loading Capacity
120×235 mm (4.72×9.25 in.)	0.38 mm (0.015 in.) or less	1 envelope
92×165 mm (3.62×6.50 in.)		

Types of Originals that Require Attention

The following types of originals may not be successfully scanned.

- Originals with an uneven surface such as letter head paper.
- Originals with crinkles or fold lines
- Original with labels or stickers
- Carbon-less paper
- Curled originals
- Coated paper
- Thermal paper
- Originals with punch holes
- Originals with folded corners

Specifications of Originals and Placing Originals

- Receipts over 355.6 mm (14 inches) in length
- Thick originals

Note:

- Because carbon-less paper contains chemical substances that may harm the rollers, if paper jams occur frequently, clean the pickup roller and the separation pad.*
- Labels or stickers must be firmly stuck to the originals with no glue protruding.*
- Try to flatten the curled originals before scanning.*

Related Information

- ➔ [“Maintenance” on page 100](#)

Types of Originals that Must Not be Scanned

The following types of originals must not be scanned.

- Photos
- Photo paper
- Booklets
- Non-paper original (such as clear files, fabric, and metal foil)
- Originals with staples or paper clips
- Originals with glue attached
- Ripped originals
- Heavily wrinkled or curled originals
- Transparent originals such as OHP film
- Originals with carbon paper on the back
- Originals with wet ink
- Originals with sticky notes attached
- Perforated originals
- Plastic cards complying with ISO7810 ID-1 type *
- Laminated cards with ISO7810ID-1 size *

* These cards can be scanned from the card slot.

Related Information

- ➔ [“Placing Standard Size Originals in the ADF” on page 28](#)
- ➔ [“Placing Long Paper in the ADF” on page 33](#)
- ➔ [“Placing Receipts in the ADF” on page 38](#)
- ➔ [“Placing Thick Originals in the ADF” on page 42](#)
- ➔ [“Placing Envelopes in the ADF” on page 45](#)
- ➔ [“Placing Plastic Cards in the Card Slot” on page 48](#)

Specifications of Originals and Placing Originals

Specifications for Plastic Cards for Scanning from the Card Slot

These are the specifications for plastic cards that you can load into the scanner from the card slot.

Note:

- You can scan plastic cards from the card slot at the front. You cannot scan from the ADF.
- Although you cannot scan card from ADF, you can leave the ADF as the **Document Source** setting in *Epson Scan 2*.

Size	Card Type	Thickness	Loading Capacity	Loading Direction
ISO7810 ID-1 Type 54.0×85.6 mm (2.1×3.3 in.)	Without embossing	1.0 mm (0.04 in.) or less	1 card	Vertical (Portrait)

Types of Cards that Require Attention

The following types of cards may not be successfully scanned.

- ISO7810 ID-1 Type plastic cards with emboss (the thickness should be 1.24 mm (0.05 in.) or less)
- ISO7810 ID-1 size laminated cards (the thickness should be 0.6 mm (0.02 in.) or less)

Related Information

- ➔ [“Placing Plastic Cards in the Card Slot” on page 48](#)

Placing Standard Size Originals in the ADF

Specifications of Standard Size Originals

These are the specifications for standard size originals that you can load into the ADF.

Specifications of Originals and Placing Originals

Size	Measurement	Thickness	Paper Type	Loading Capacity *
A4	210×297 mm (8.3×11.7 in.)	51.8 to 128 g/m ²	Plain paper Fine paper Recycled paper	Thickness of the originals stack: under 2 mm (0.07 in.) 64 g/m ² : 25 sheets 80 g/m ² : 20 sheets 128 g/m ² : 12 sheets The loading capacity varies depending on the paper type.
Letter	215.9×279.4 mm (8.5×11 in.)			
Legal	215.9×355.6 mm (8.5×14 in.)			
B5	182×257 mm (7.2×10.1 in.)			
A5	148×210 mm (5.8×8.3 in.)			
B6	128×182 mm (5.0×7.2 in.)			
A6	105×148 mm (4.1×5.8 in.)			
Business Card	55×89 mm (2.1×3.4 in.)	128 to 230 g/m ²		Thickness of the originals stack: under 2mm (0.07 in.) 190 g/m ² : 8 sheets 220 g/m ² : 6 sheets
Post Cards	100×148 mm (3.9×5.8 in.)	128 to 230 g/m ²	Plain paper Fine paper Recycled paper	Thickness of the originals stack: under 2 mm (0.07 in.) 190 g/m ² : 8 sheets 220 g/m ² : 6 sheets

* You can refill the originals up to the maximum capacity during scanning.

Specifications of Originals and Placing Originals

Placing Standard Size Originals

1. Slide the input tray open lever to the left, open the input tray, and then pull out the input tray extension.

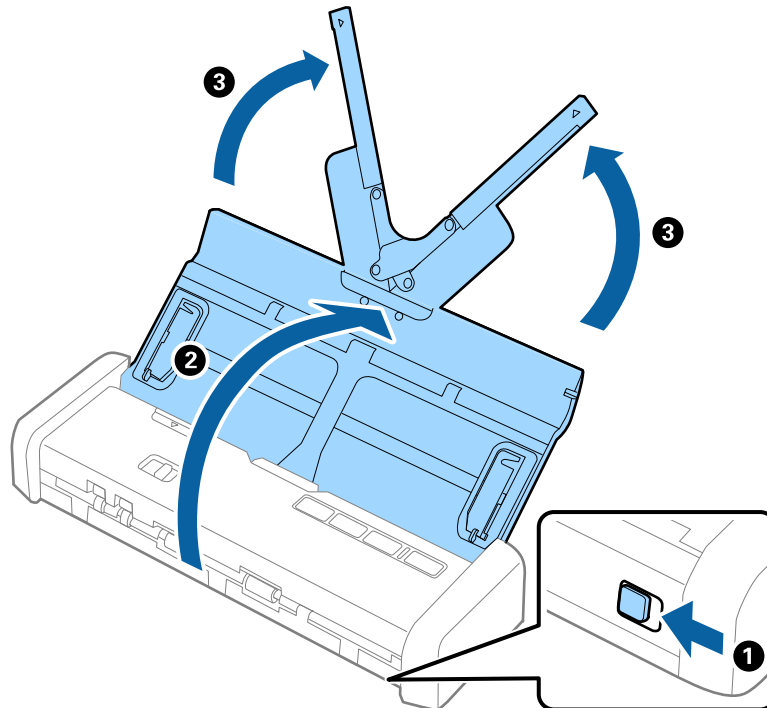

Note:

Make sure there is enough space in front of the scanner for the ejected originals.

2. Make sure that the feed selector is set to  (ADF) and the scanner is turned on.

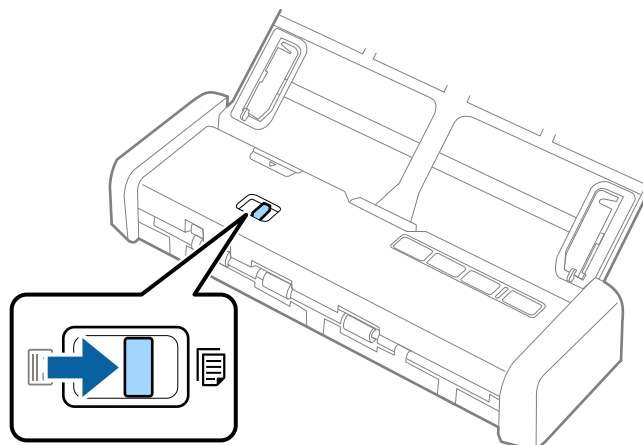

Specifications of Originals and Placing Originals

3. Raise the edge guides and slide the input tray all the way out.

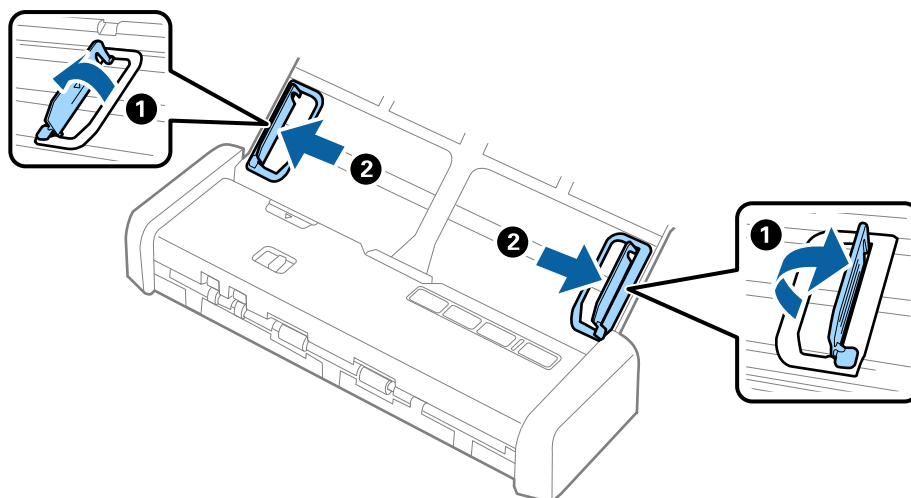

4. Fan the originals.
Hold both ends of the originals and fan them a few times.

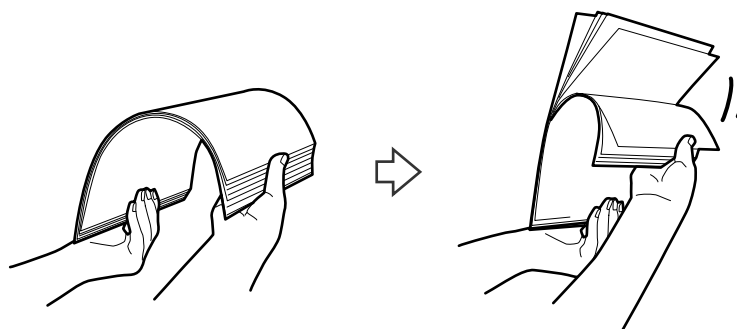

5. Align the edges of the originals with the printed side facing down and slide the leading edge into a wedge shape.

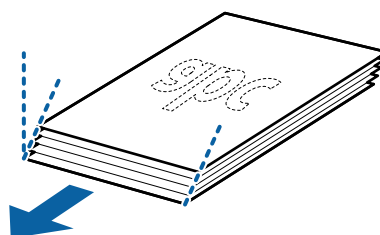

Specifications of Originals and Placing Originals

6. Load the originals into the input tray facing down with the top edge facing into the ADF. Slide the originals into the ADF until they meet resistance and the Ready light becomes brighter.

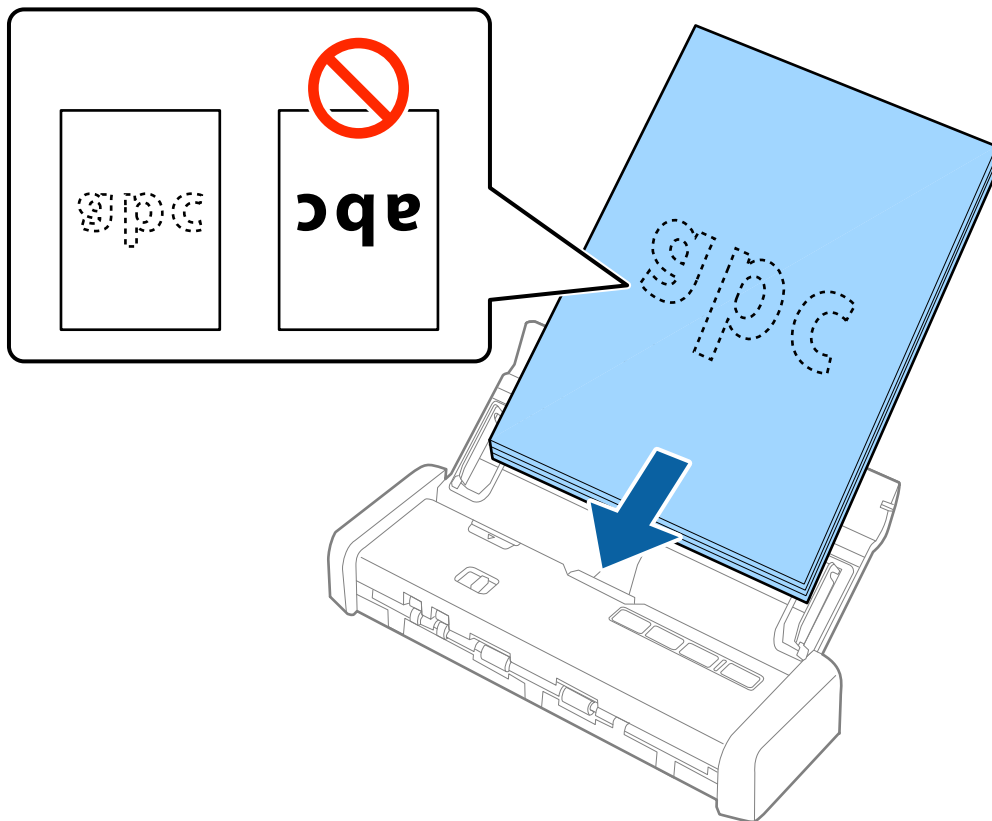

7. Slide the edge guides to fit the edge of the originals making sure there are no gaps between the originals and the edge guides. Otherwise, the originals may be fed skewed.

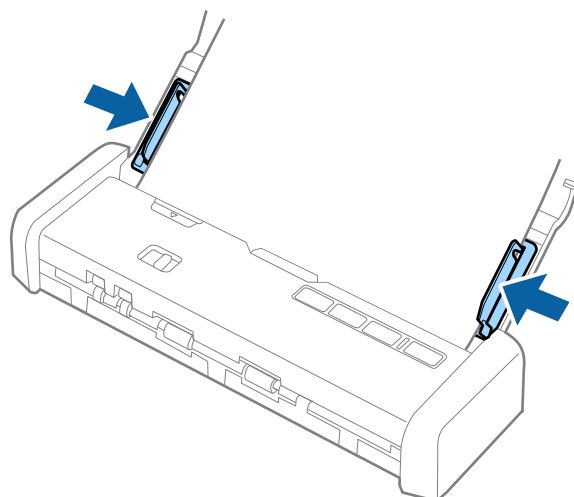

Specifications of Originals and Placing Originals

Note:

- ❑ You can preview the scanned image using Epson Scan 2. If you want to preview, load only the first page of your originals into the input tray. The page is ejected after it is scanned and a preview image is generated. Load the ejected page again together with the rest of the originals.
- ❑ If you set a batch of originals and perform previewing, the second page will be fed a little bit into the ADF. Open the scanner cover to remove it from the ADF, and then load the page again together with the first page and the rest of the originals.
- ❑ Also if you cancel scanning in the middle of scanning a batch of originals, the next page will be fed a little bit into the ADF and scanning stopped. You need to open the scanner cover to remove the page.

Related Information

- ➔ [“Basic Scanning” on page 52](#)
- ➔ [“Advanced Scanning” on page 63](#)

Placing Long Paper in the ADF

Specifications of Long Paper

These are the specifications for long paper that you can load into the scanner.

Size	Thickness	Paper Type	Loading Capacity
Width: 50.8 to 215.9 mm (2.0 to 8.5 in.) Length: 368.3 to 1,117.6 mm (14.5 to 44 in.)	51.8 to 128 g/m ²	Plain paper Fine paper Recycled paper	1 sheet

Specifications of Originals and Placing Originals

Placing Long Paper

1. Slide the input tray open lever to the left and open the input tray.

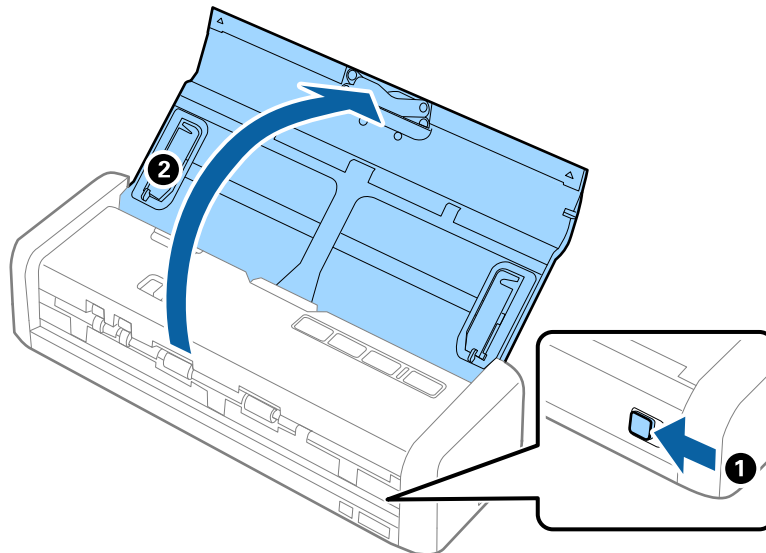

Note:

Do not pull out the input tray extension.

2. Make sure that the feed selector is set to  (ADF) and the scanner is turned on.

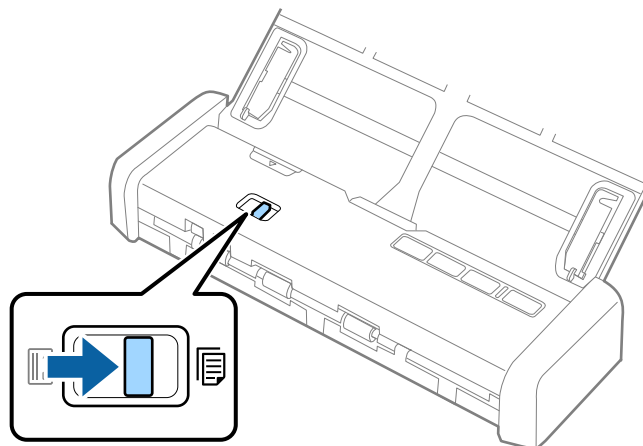

Specifications of Originals and Placing Originals

3. Raise the edge guides and slide the input tray all the way out.

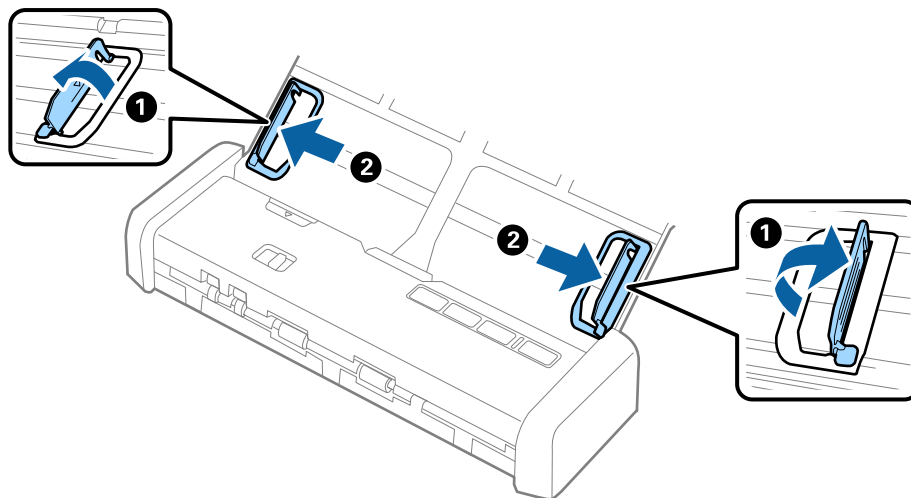

4. Load the original straight into the input tray, facing down with the top edge facing into the ADF. Slide the original into the ADF until it meets resistance and the Ready light becomes brighter.

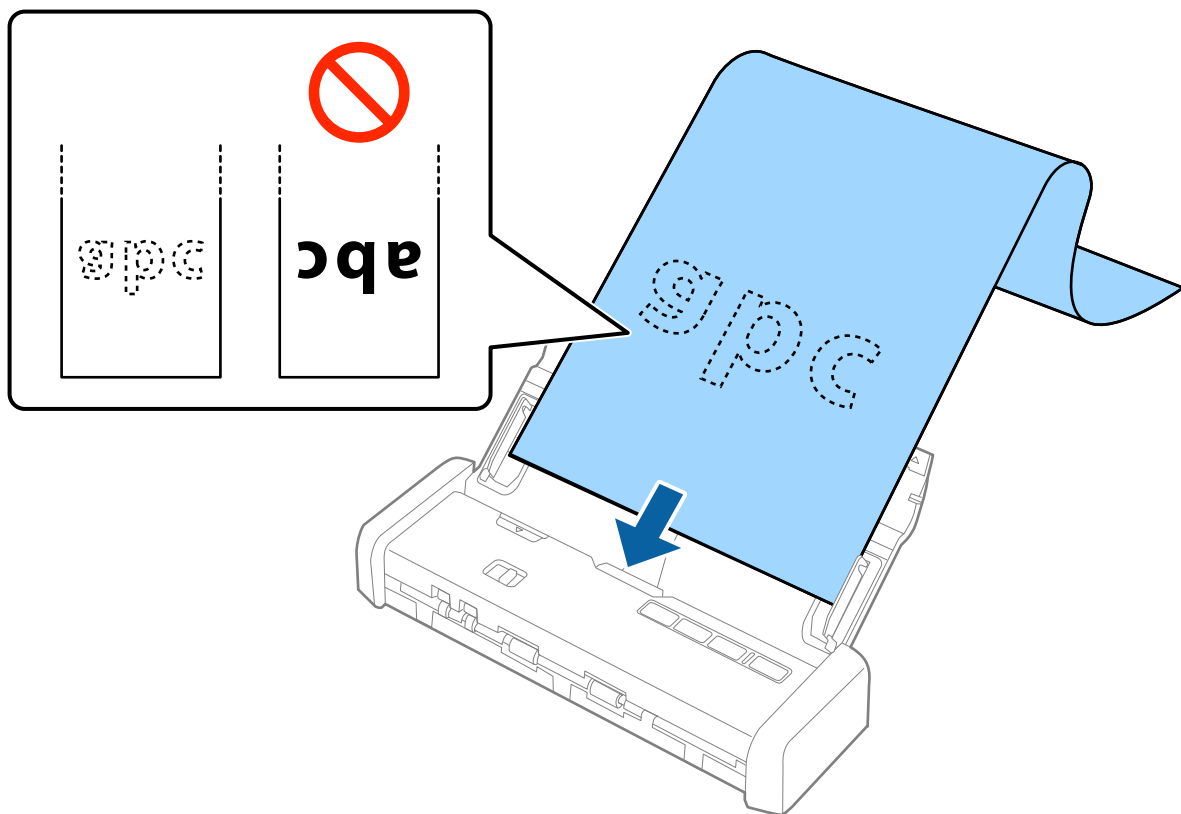

Specifications of Originals and Placing Originals

5. Adjust the edge guides to fit the edge of the long paper making sure there are no gaps between the edge of the paper and the edge guides. Otherwise, the originals may be fed skewed.

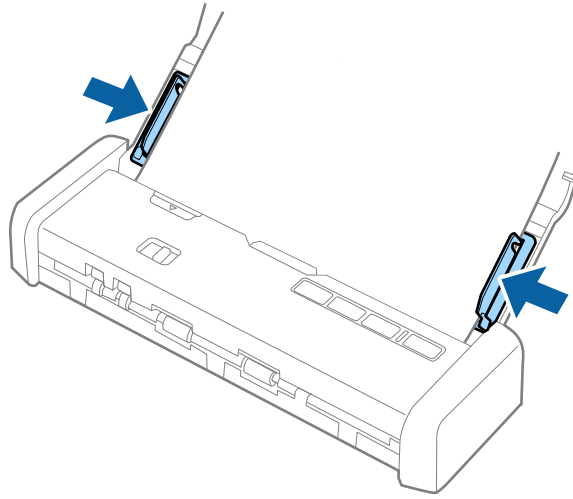

Specifications of Originals and Placing Originals

Note:

- ❑ You can scan long paper up to 1,117.6 mm (44 inches) in length with a resolution of 300 dpi or less.
- ❑ You need to specify the paper size in Epson Scan 2. There are three ways to specify the paper size in Epson Scan 2, if the paper length is 863.6 mm (34 inches) or less, you can select **Auto Detect (Long Paper)** to detect the size automatically.
If the paper length is more than 863.6 mm (34 inches), you need to select **Customize** and enter the size of the paper. You can either enter the width and height of the paper or use **Detect paper length** instead of entering the paper height.
- ❑ Support the long paper on the input side so that it does not drop out of the ADF, and on the output side so that the ejected paper does not fall from the output slot.

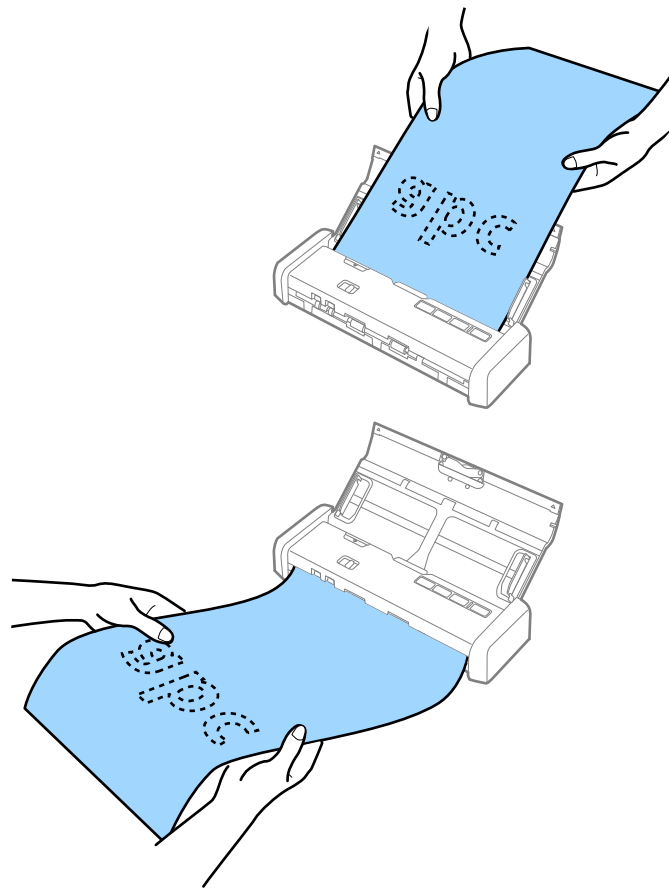

Related Information

- ➔ [“Required Settings for Special Originals in Epson Scan 2” on page 55](#)
- ➔ [“Basic Scanning” on page 52](#)
- ➔ [“Advanced Scanning” on page 63](#)

Placing Receipts in the ADF

Specifications for Receipts

These are the specifications for receipts that you can load into the scanner.

Size	Thickness	Paper Type	Loading Capacity
Maximum: 76.2×355.6 mm (3.0×14 in.) Minimum: 76.2×76.2 mm (3.0×3.0 in.)	53 to 77 g/m ²	Plain paper Fine paper Recycled paper	1 sheet*

* Receipts need to be scanned using Automatic Feeding Mode. Only one receipt should be loaded at once and you need to hold the receipt for a good quality scan.

Placing Receipts

1. Slide the input tray open lever to the left and open the input tray.

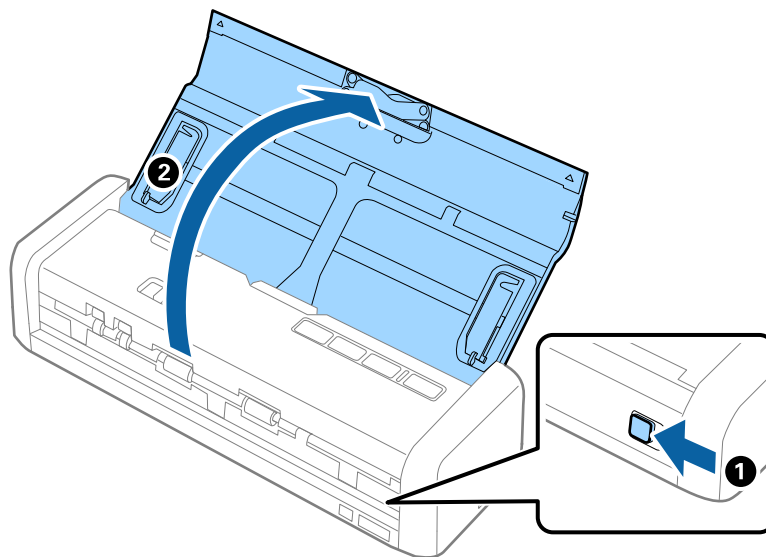

Note:

Do not pull out the input tray extension.

Specifications of Originals and Placing Originals

2. Make sure that the feed selector is set to  (ADF) and the scanner is turned on.

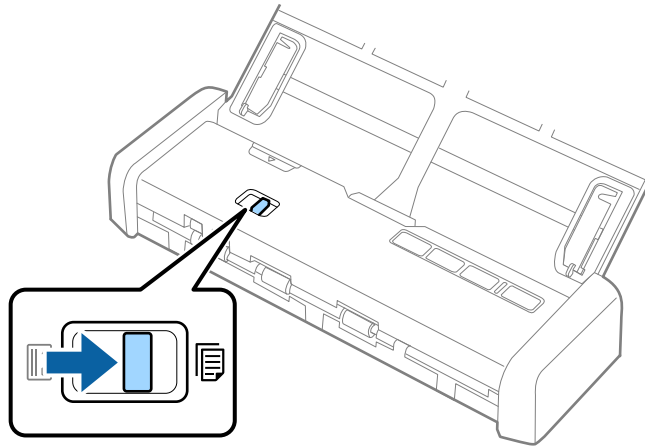

3. Start Epson Scan 2, select **Automatic Feeding Mode**, and then click **Scan** on the **Main Settings** tab. The **Automatic Feeding Mode** light on the scanner turns on.

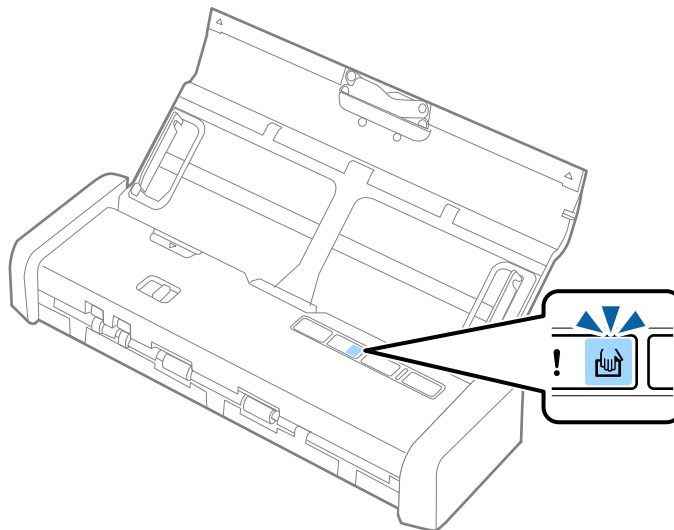

Specifications of Originals and Placing Originals

4. Raise the edge guides and slide to adjust to the width of the receipt.

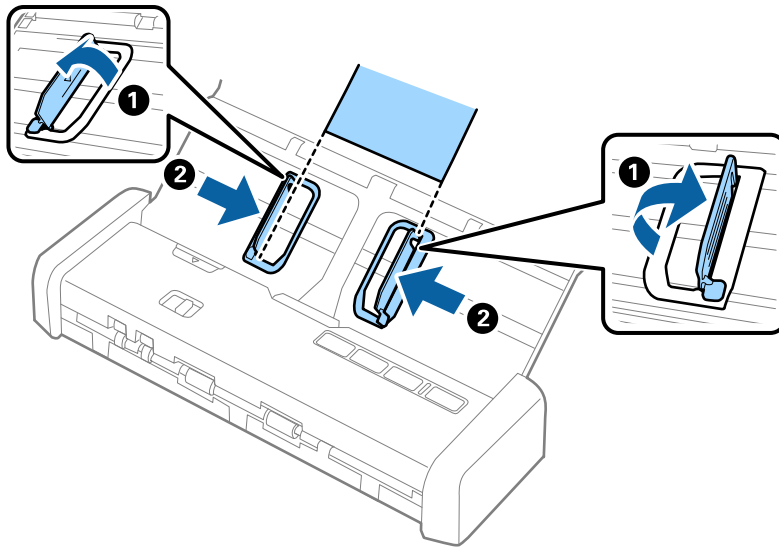

5. Supporting it by hand, load the receipt straight into the input tray, facing down with the top edge facing into the ADF.

Slide the receipt into the ADF until it is fed automatically into the ADF.

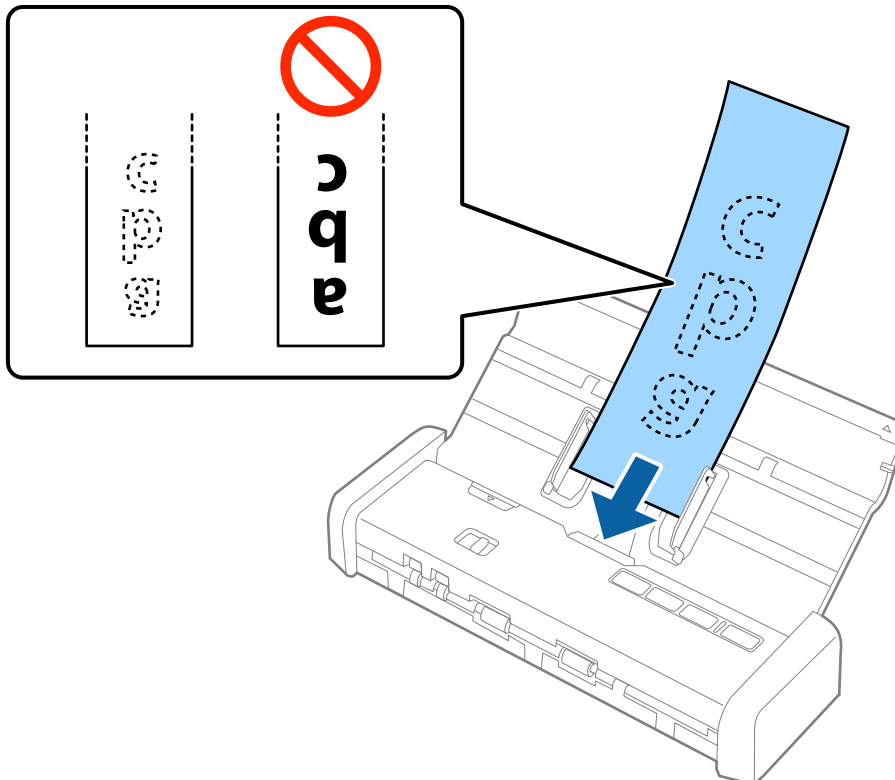

Specifications of Originals and Placing Originals

- The receipt is automatically fed into the scanner and scanning starts. Support the receipt by hand while it is scanned.

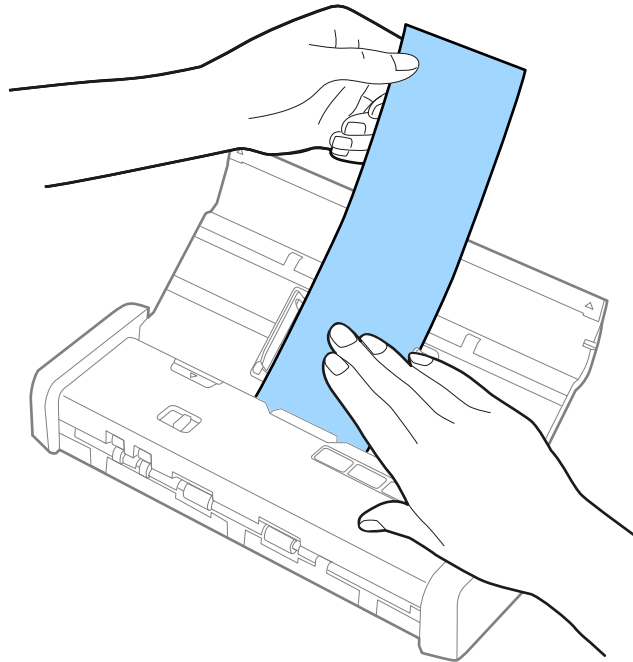

You can load the next receipt into the ADF to start the next scan while the scanner is in **Automatic Feeding Mode**.

After you have scanned all receipts, press the  button on the scanner to close **Automatic Feeding Mode**.

Note:

- ❑ Although there may be issues with the scanning quality, you can scan long receipts up to 1,117.6 mm (44 inches) in length at a resolution of 300 dpi or less as long as you support the receipt on the input side so that it does not drop out of the ADF, and the output side so that the ejected receipt does not fall from the output slot.
- ❑ You need to specify the paper size in Epson Scan 2. There are three ways to specify the paper size in Epson Scan 2, if the paper length is 863.6 mm (34 inches) or less, you can select **Auto Detect (Long Paper)** to detect the size automatically.

If the paper length is more than 863.6 mm (34 inches), you need to select **Customize** and enter the size of the paper. You can either enter the width and height of the paper or use **Detect paper length** instead of entering the paper height.

Related Information

- ➔ [“Scanning Different Sizes or Types of Originals One by One \(Automatic Feeding Mode\)” on page 63](#)
- ➔ [“Required Settings for Special Originals in Epson Scan 2” on page 55](#)
- ➔ [“Basic Scanning” on page 52](#)
- ➔ [“Advanced Scanning” on page 63](#)

Specifications of Originals and Placing Originals

Placing Thick Originals in the ADF

Specifications for Thick Originals

These are the specifications for thick originals, such as business cards or post cards, that you can load into the scanner.

Size	Thickness	Loading Capacity	Loading Direction
50.8×70 mm to 100×148 mm (2×2.8 in. to 3.9×5.8 in.)	128 to 230 g/m ²	Thickness of the originals stack: under 2 mm (0.07 in.) 190 g/m ² : 8 sheets 220 g/m ² : 6 sheets	Vertical (Portrait)

Placing Thick Originals

1. Slide the input tray open lever to the left, open the input tray, and then pull out the input tray extension.

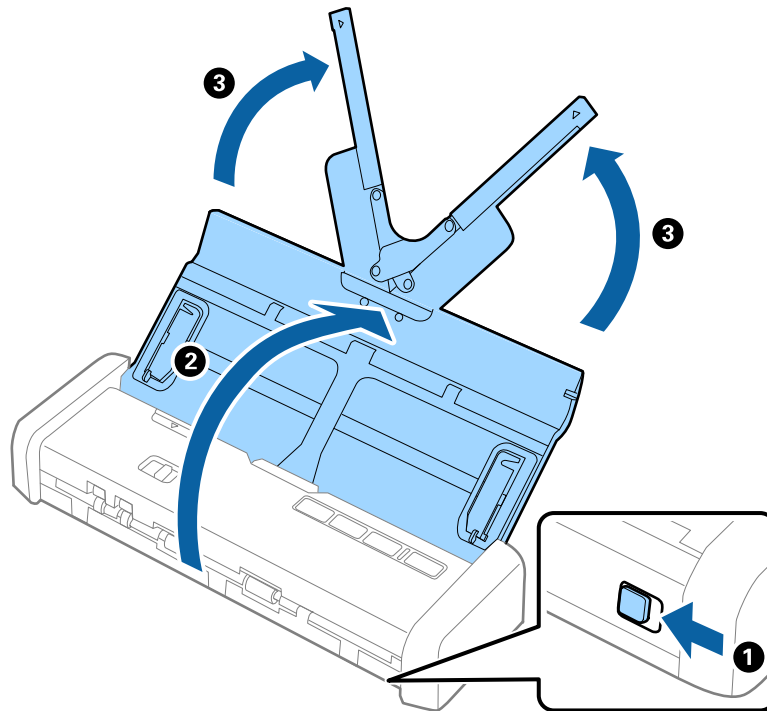

Specifications of Originals and Placing Originals

2. Make sure that the feed selector is set to  (ADF) and the scanner is turned on.

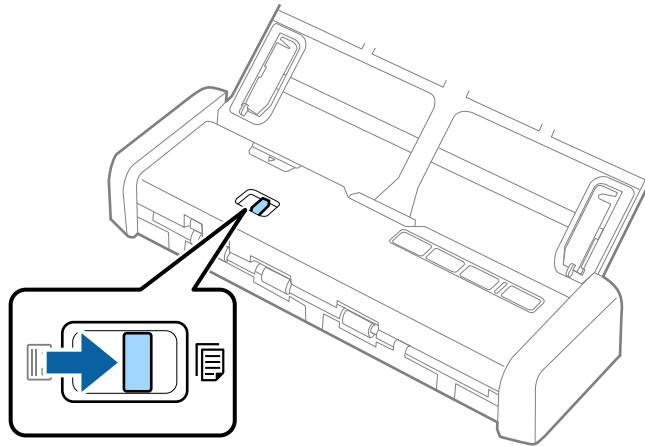

3. Raise the edge guides and slide the input tray all the way out.

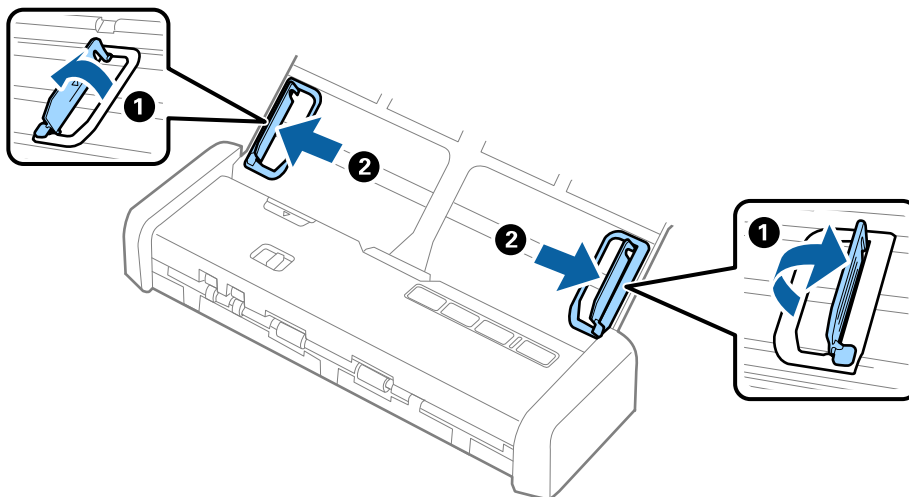

Specifications of Originals and Placing Originals

4. Load the thick originals into the input tray facing down with the top edge facing into the ADF. Slide the thick originals into the ADF until they meet resistance and the Ready light becomes brighter.

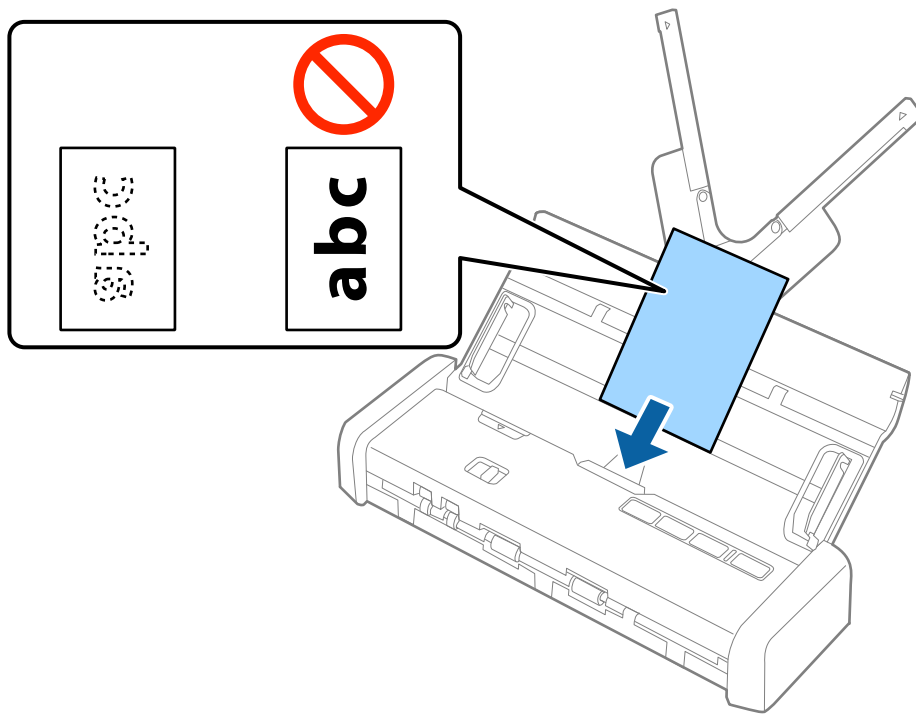

! *Important:*

Do not load thick originals horizontally.

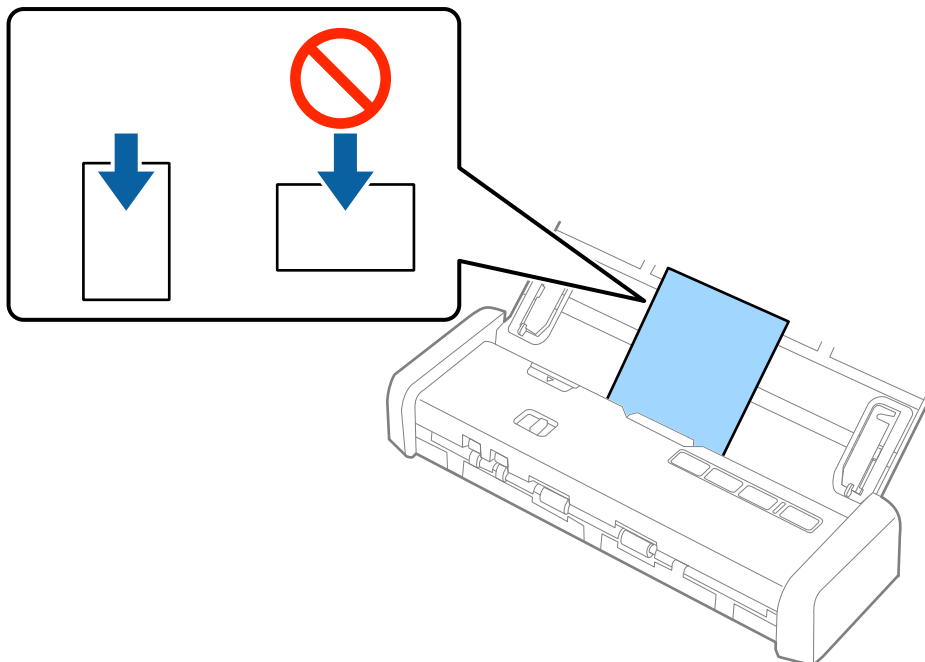

Specifications of Originals and Placing Originals

5. Slide the edge guides to fit the edge of the thick originals.

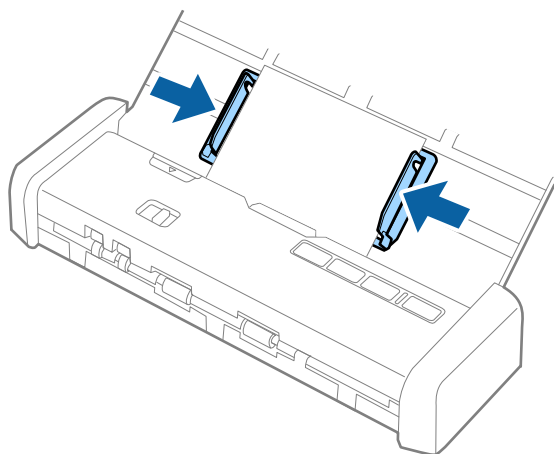

Note:

- ❑ You can preview the scanned image using Epson Scan 2. If you want to preview, load only the first page of your originals into the input tray. The page is ejected after it is scanned and a preview image is generated. Load the ejected page again together with the rest of the originals.
- ❑ If you set a batch of originals and perform previewing, the second page will be fed a little bit into the ADF. Open the scanner cover to remove it from the ADF, and then load the page again together with the first page and the rest of the originals.
- ❑ Also if you cancel scanning in the middle of scanning a batch of originals, the next page will be fed a little bit into the ADF and scanning stopped. You need to open the scanner cover to remove the page.

Related Information

- ➔ [“Basic Scanning” on page 52](#)
- ➔ [“Advanced Scanning” on page 63](#)

Placing Envelopes in the ADF

Specifications of Envelopes

These are the specifications for envelopes that you can load into the scanner.

Measurement	Thickness	Loading Capacity
120×235 mm (4.72×9.25 in.)	0.38 mm (0.015 in.) or less	1 envelope
92×165 mm (3.62×6.50 in.)		

Specifications of Originals and Placing Originals

Placing Envelopes

1. Slide the input tray open lever to the left, open the input tray, and then pull out the input tray extension.

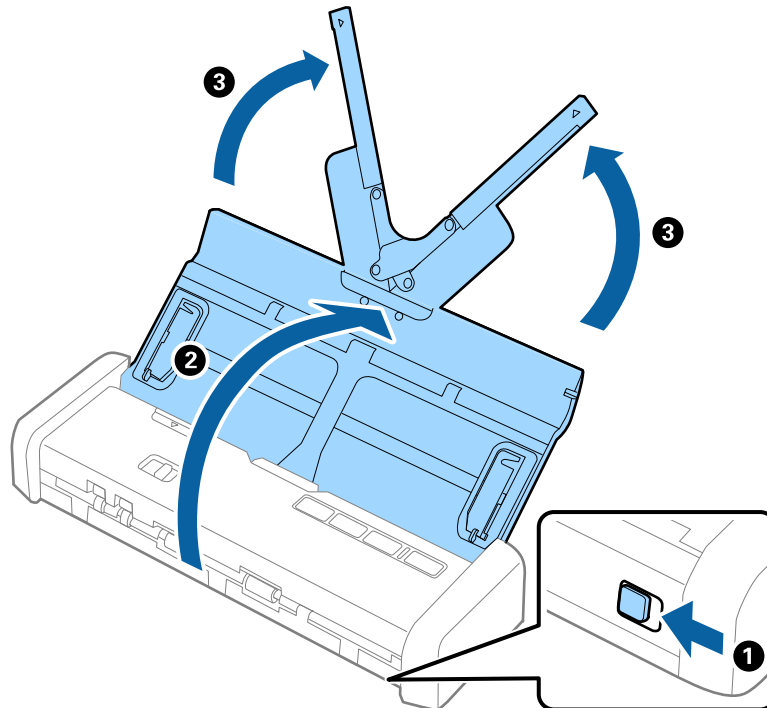

2. Make sure that the feed selector is set to  (ADF) and the scanner is turned on.

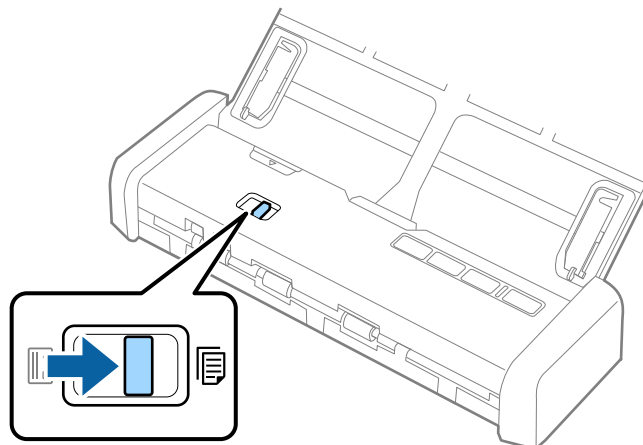

Specifications of Originals and Placing Originals

3. Raise the edge guides and slide the edge guides on the input tray all the way out.

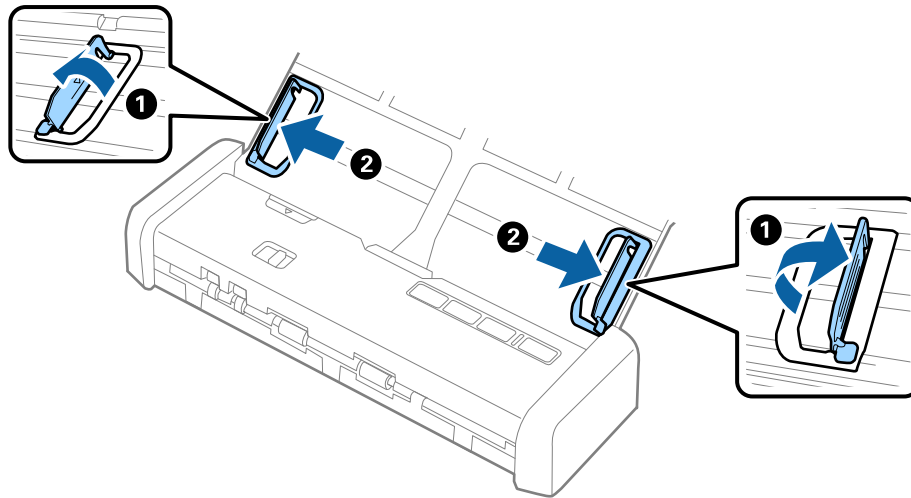

4. Load the envelope into the input tray facing down making sure that the opened edge (flap side) of the envelope is facing to the side. For envelopes with the opened edge (flap side) on the shorter side, you can load the envelope with the opened edge (flap side) facing up.

Slide the envelope into the ADF until they meet resistance and the Ready light becomes brighter.

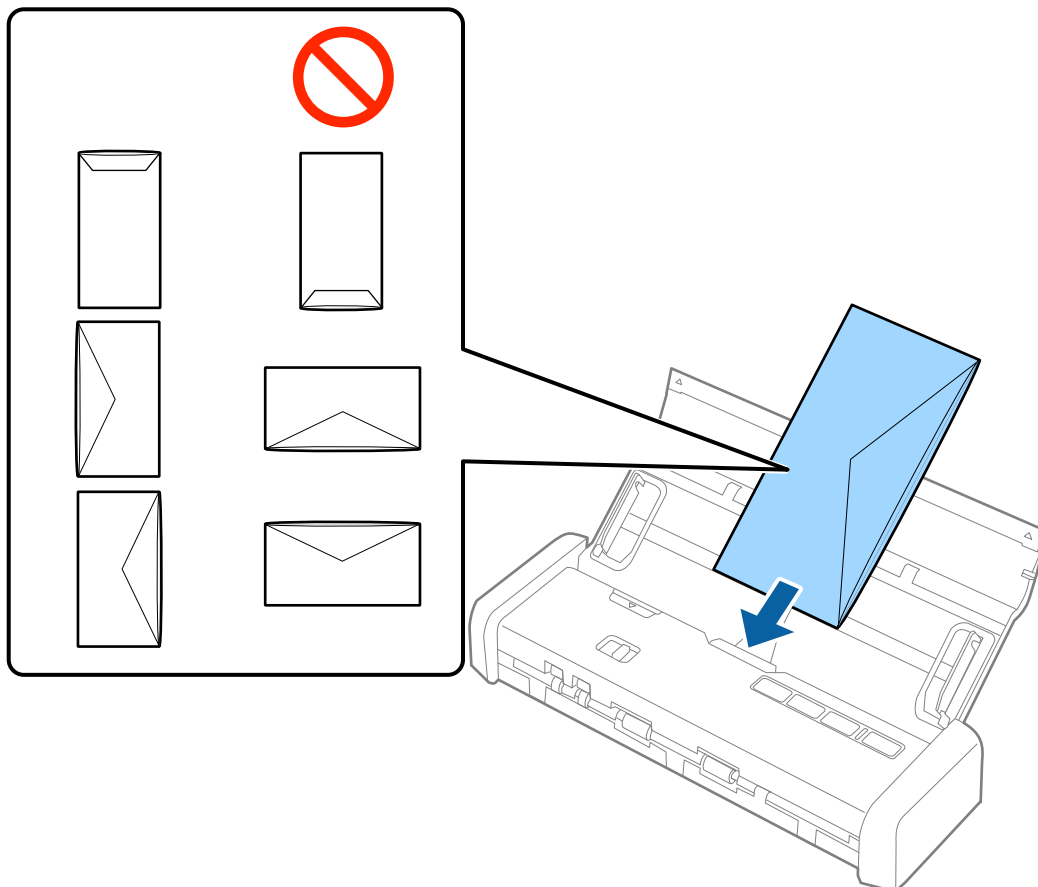

Specifications of Originals and Placing Originals

! **Important:**

Do not load envelopes with adhesives on them.

Note:

- Envelopes that are not opened by cutting sharply at the flap edge may not be scanned correctly.
 - Envelopes that have not yet been sealed can be loaded with the flap open and facing up.
5. Slide the edge guides to fit the edge of the envelope making sure there are no gaps between the envelope and the edge guides. Otherwise, the envelope may be fed skewed.

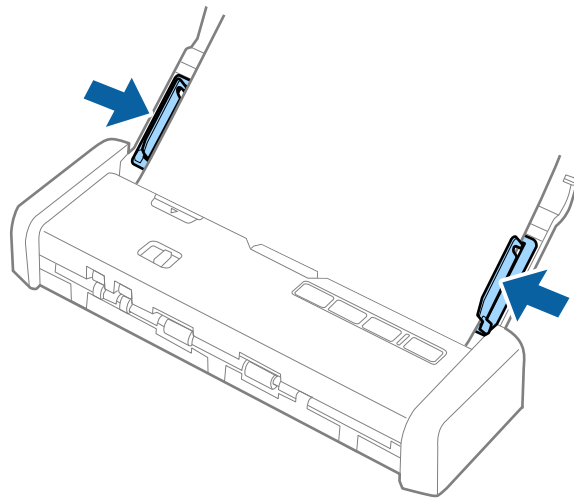
**Note:**

To scan envelopes, we recommend selecting the appropriate rotation angle or **Auto** in **Rotate** on the **Main Settings** tab in *Epson Scan 2* before scanning. See the *Epson Scan 2* help for details.

Related Information

- ➔ [“Basic Scanning” on page 52](#)
- ➔ [“Advanced Scanning” on page 63](#)

Placing Plastic Cards in the Card Slot

Specifications for Plastic Cards for Scanning from the Card Slot

These are the specifications for plastic cards that you can load into the scanner from the card slot.

Note:

- You can scan plastic cards from the card slot at the front. You cannot scan from the ADF.
- Although you cannot scan card from ADF, you can leave the ADF as the **Document Source** setting in *Epson Scan 2*.

Specifications of Originals and Placing Originals

Size	Card Type	Thickness	Loading Capacity	Loading Direction
ISO7810 ID-1 Type 54.0×85.6 mm (2.1×3.3 in.)	Without embossing	1.0 mm (0.04 in.) or less	1 card	Vertical (Portrait)

Types of Cards that Require Attention

The following types of cards may not be successfully scanned.

- ISO7810 ID-1 Type plastic cards with emboss (the thickness should be 1.24 mm (0.05 in.) or less)
- ISO7810 ID-1 size laminated cards (the thickness should be 0.6 mm (0.02 in.) or less)

Related Information

➔ [“Placing Plastic Cards in the Card Slot” on page 48](#)

Placing Plastic Cards

1. Slide the input tray open lever to the left and open the input tray.

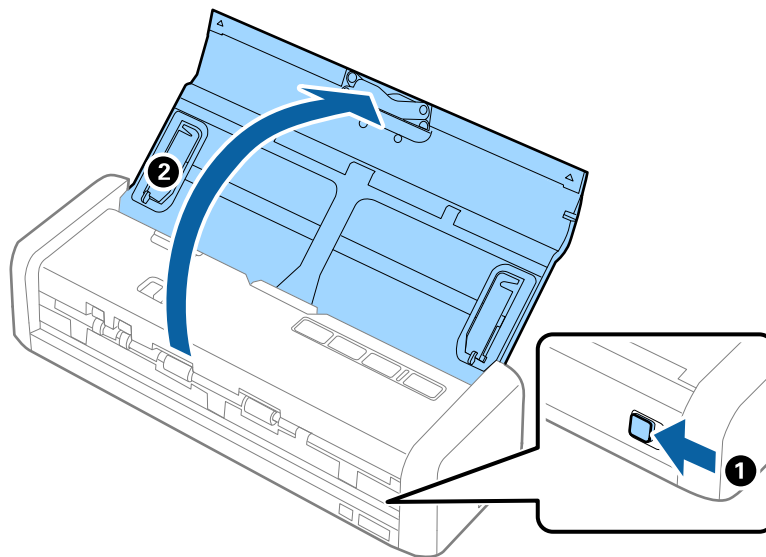

Specifications of Originals and Placing Originals

2. Make sure that the feed selector is set to  (card) and the scanner is turned on.

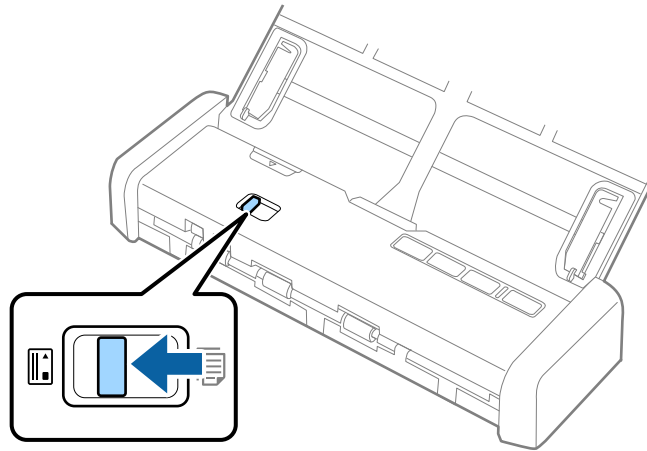

3. Load the plastic card facing up, vertically, and straight into the card slot until the leading edge of the card is pulled in slightly by the scanner.

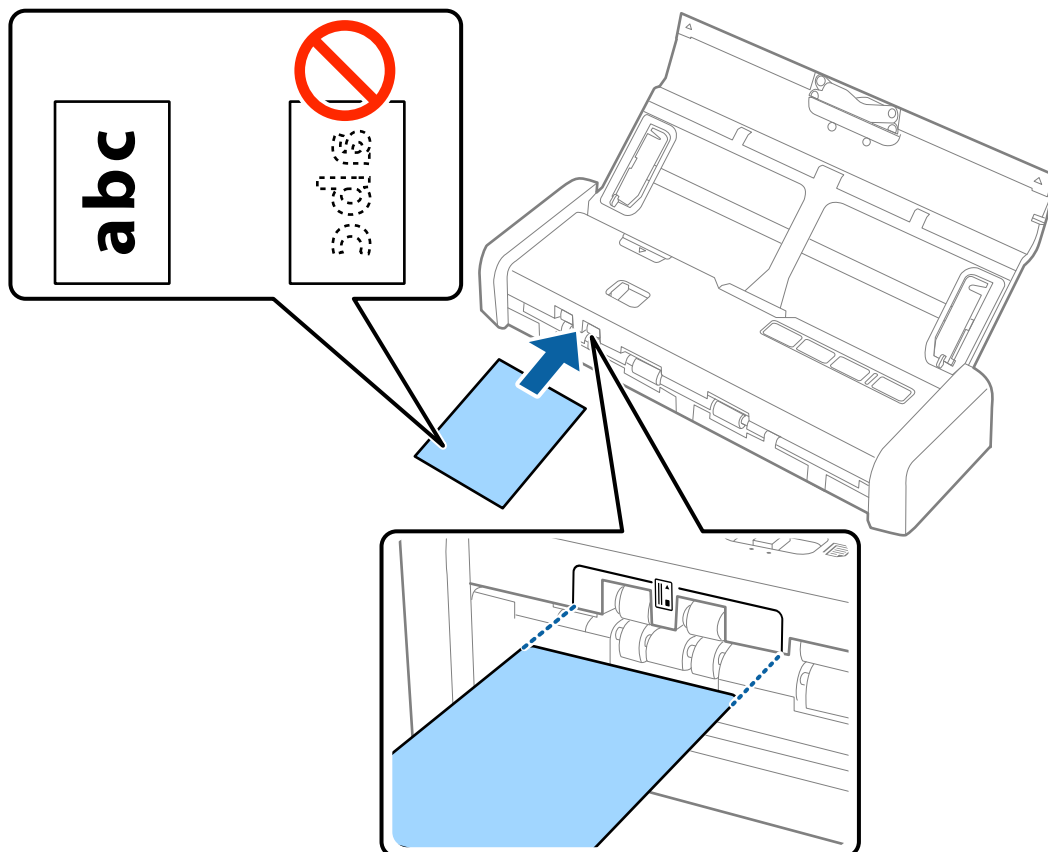

Specifications of Originals and Placing Originals

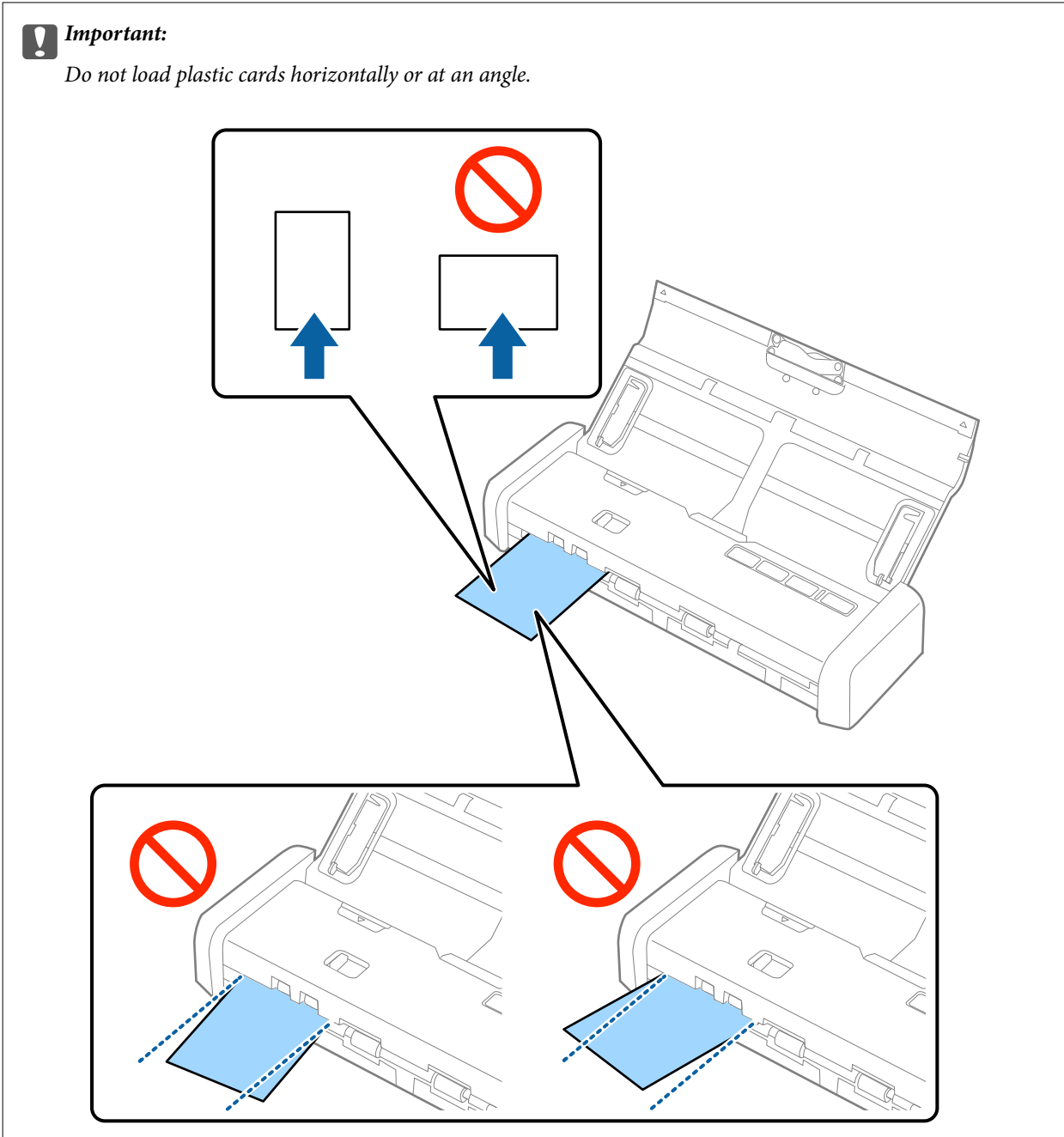
**Note:**

- ❑ Although the card has to be placed in the card slot at the front, you can only select **ADF** as the **Document Source** in *Epson Scan 2*.
- ❑ When scanning starts, the card is taken into the scanner, protrudes slightly from the slot at the back, and then returns through the scanner and is ejected from the card slot at the front. Do not touch the card until it is ejected.

Related Information

- ➔ “Basic Scanning” on page 52
- ➔ “Advanced Scanning” on page 63

Basic Scanning

Scanning Using Epson Scan 2

You can scan the originals using detailed settings that are suitable for text documents.

1. Place the original.
2. Start Epson Scan 2.
 - Windows 10
Click the start button, and then select **All apps > EPSON > Epson Scan 2**.
 - Windows 8.1/Windows 8/Windows Server 2012 R2/Windows Server 2012
Enter the application name in the search charm, and then select the displayed icon.
 - Windows 7/Windows Vista/Windows XP/Windows Server 2008 R2/Windows Server 2008/Windows Server 2003 R2/Windows Server 2003
Click the start button, and then select **All Programs** or **Programs > EPSON > Epson Scan 2 > Epson Scan 2**.
 - Mac OS X
Select **Go > Applications > Epson Software > Epson Scan 2**.

Basic Scanning

3. Make the following settings on the **Main Settings** tab.

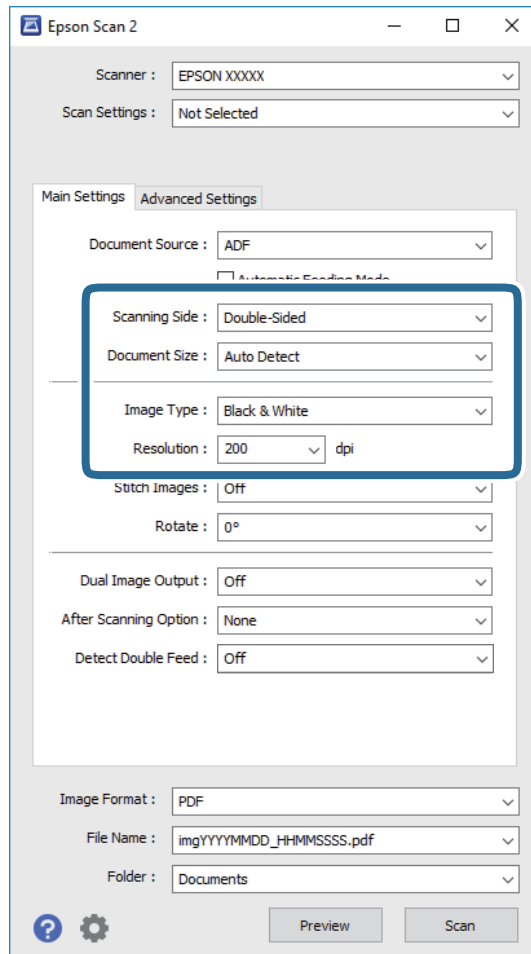

- Scanning Side:** Select the side of the original you want to scan.
- Document Size:** Select the size of the original you placed.
- Image Type:** Select the color for saving the scanned image.
- Resolution:** Select the resolution.

Note:

*ADF is set as the **Document Source** automatically.*

4. Make other scan settings if necessary.

- You can preview the scanned image. Load only the first page of your originals into the input tray and click the **Preview** button. The preview window opens, the previewed image is displayed, and the page is ejected from the ADF.

Replace the ejected page together with the rest of originals.

Basic Scanning

- ❑ On the **Advanced Settings** tab, you can make image adjustments using detailed settings which are suitable for text documents, such as the following.
 - ❑ **Unsharp Mask:** Select to enhance and sharpen the outlines of the image.
 - ❑ **Descreening:** Select to remove moiré patterns (web-like shadows) that appear when scanning printed papers such as a magazine.
 - ❑ **Text Enhancement:** Select to make blurred letters in the original clear and sharp.
 - ❑ **Auto Area Segmentation:** Select to make letters clear and images smooth when performing black and white scanning for a document that contains images.

Note:

Some items may not be available depending on other settings you made.

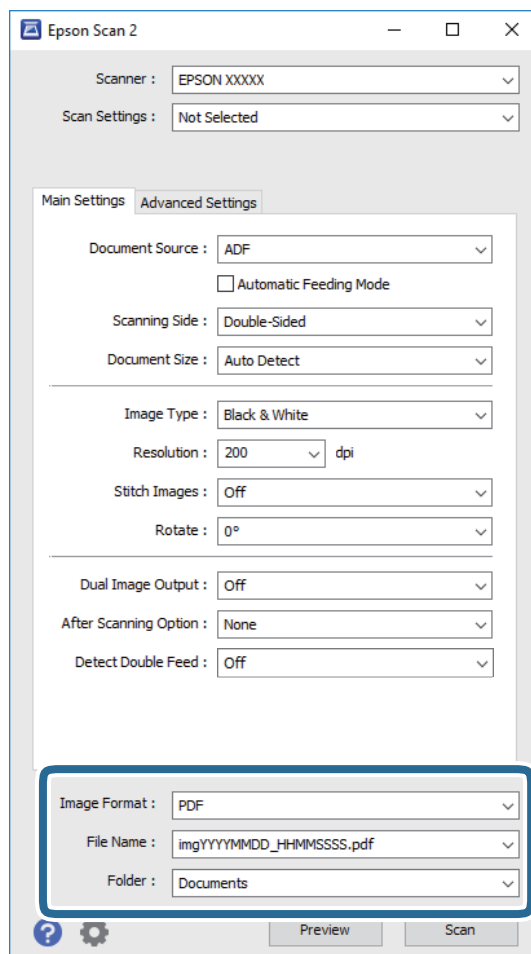

5. Set the file saving settings.



- ❑ **Image Format:** Select the save format from the list.
You can make detailed settings for each save format except BITMAP and PNG. After selecting the save format, select **Options** from the list.
- ❑ **File Name:** Check the save file name displayed.
You can change settings for file name by selecting **Settings** from the list.
- ❑ **Folder:** Select the save folder for the scanned image from the list.
You can select other folder or create a new folder by selecting **Select** from the list.

Basic Scanning

6. Make sure the feed selector on the scanner is set correctly.

To scan originals using ADF, set the feed selector to  (ADF). To scan a plastic card using the card slot, set the feed selector to  (card).

7. Click **Scan**.

The scanned image is saved to the folder you specified.

Related Information

- ➔ [“Specifications of Originals and Placing Originals” on page 24](#)
- ➔ [“Epson Scan 2” on page 18](#)
- ➔ [“Setting a Resolution That Suits the Scanning Purpose” on page 55](#)
- ➔ [“Image Adjustment Features” on page 64](#)
- ➔ [“Editing Scanned Pages Using Epson Scan 2” on page 71](#)

Required Settings for Special Originals in Epson Scan 2

You need to set certain items on the **Main Settings** tab in Epson Scan 2 when scanning special originals.

Type of Original	Required Settings
Large size originals	If the size of the original you want to scan is not on the Document Size list, select Customize to open the Document Size Settings window. Next, create the size manually on the window.
Long paper	If the size is not listed on the Document Size list, select Auto Detect (Long Paper) or select Customize to create a custom document size.

Setting a Resolution That Suits the Scanning Purpose

Advantages and Disadvantages of Increasing the Resolution

Resolution indicates the number of pixels (smallest area of an image) for each inch (25.4 mm), and is measured in dpi (dots per inch). The advantage of increasing the resolution is that the details in the image become fine. The disadvantage is that the file size becomes large.

- File size becomes large
(When you double the resolution, the file size becomes about four times larger.)
- Scanning, saving, and reading the image takes a long time
- Sending and receiving emails or faxes takes a long time
- The image becomes too large to fit the display or print on the paper

List of Recommended Resolutions to Suit Your Purpose

See the table and set the appropriate resolution for the purpose of your scanned image.

Basic Scanning

Purpose	Resolution (Reference)
Displaying on a screen Sending by email	Up to 200 dpi
Using Optical Character Recognition (OCR) Creating a text searchable PDF	200 to 300 dpi
Printing using a printer Sending by fax	200 to 300 dpi

Scanning Using Document Capture Pro (Windows)

This application allows you to perform various tasks such as saving the image to your computer, sending it by email, printing, and uploading to a server or a cloud service. You can also use a variety of methods to sort the documents into separate files, such as detecting barcodes or characters on the pages. You can also register scanning settings for a job to simplify scanning operations. See the help for details on Document Capture Pro.

1. Place the original.
2. Start Document Capture Pro.
 - Windows 10
Click the start button, and then select **All apps > Epson Software > Document Capture Pro.**
 - Windows 8.1/Windows 8
Enter the application name in the search charm, and then select the displayed icon.
 - Windows 7/Windows Vista/Windows XP
Click the start button, and then select **All Programs or Programs > Epson Software > Document Capture Pro.**

Basic Scanning

Note:

You may need to select the scanner you want to use from the scanners list.

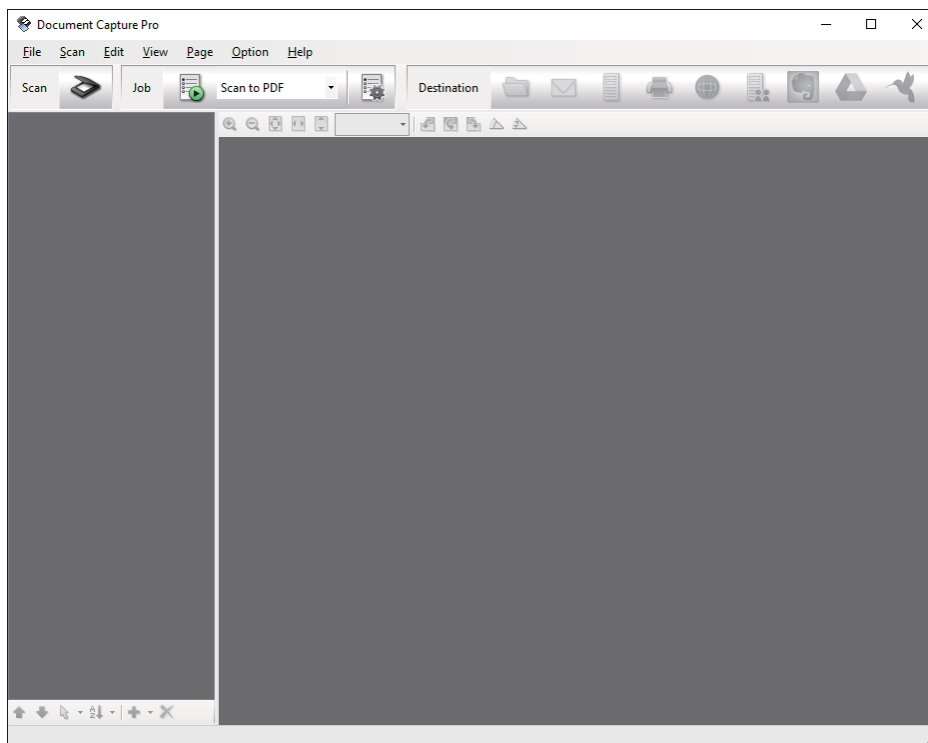

3. Click .

The **Scan** window is displayed.

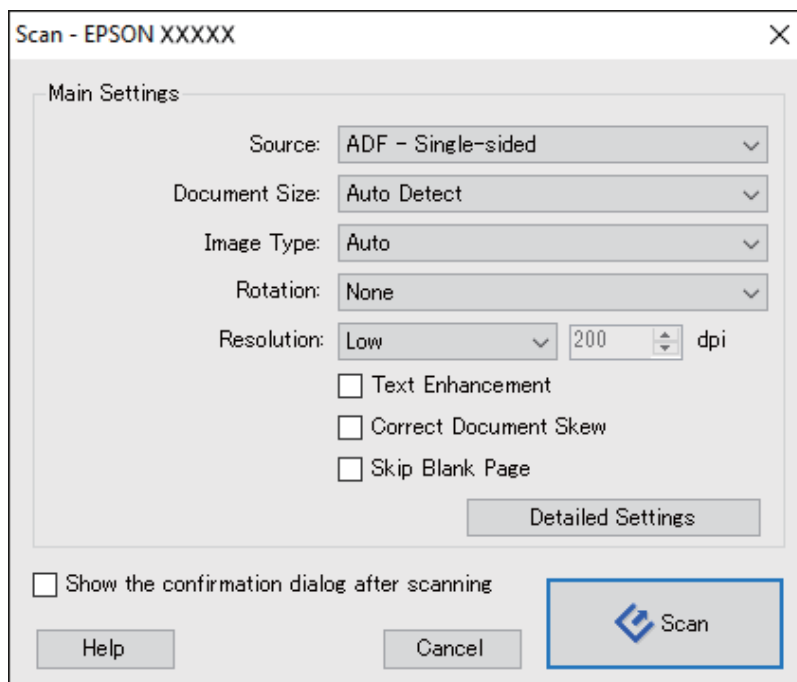

4. Make the following settings.

- Source:** Select the source where the original is placed.

Basic Scanning

- Document Size:** Select the size of the original you placed.
- Image Type:** Select the color you want to use to save the scanned image.
- Rotation:** Select the rotation angle depending on the original you want to scan.
- Resolution:** Select the resolution.

Note:

You can also adjust the image using following items.

- Text Enhancement:** Select to make blurred letters in the original clear and sharp.
- Correct Document Skew:** Select to correct the slant of the original.
- Skip Blank Page:** Select to skip blank pages if there are any in the originals.
- Detailed Settings** button: Select to use Epson Scan 2 features to adjust scanned images.

5. Make sure the feed selector on the scanner is set correctly.

To scan originals using ADF, set the feed selector to  (ADF). To scan a plastic card using the card slot, set the feed selector to  (card).

6. Click **Scan**.

The scanned document is displayed in Document Capture Pro.

7. Check the scanned images, and edit them if necessary.

8. When you have finished checking the image, click one of the destination icons.

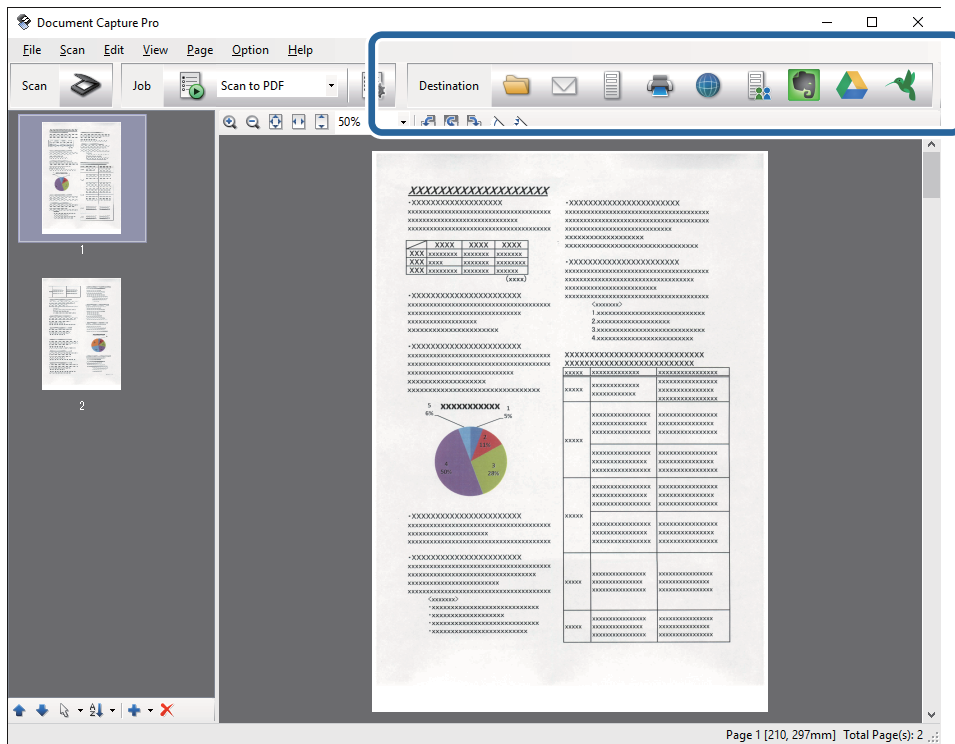

One of the following windows is displayed depending on the icon you selected; **Batch Save**, **Transfer Settings**, or another window.

Basic Scanning

Note:

- ❑ *If you want to upload to a cloud service, you need to set up your account with the cloud service in advance.*
- ❑ *If you want to use Evernote as the destination, download the Evernote application from the Evernote Corporation Website and install it before using this feature.*
- ❑ *On the **Batch Save** window or the **Transfer Settings** window, click **File Name & Separation Settings**, and then select **Apply job separation** to sort the documents into separate files by using a variety of detection methods such as barcodes or text in the scanned images.*

9. Make settings for each item in the window, and then click **Send** or **OK**.

10. Follow the on-screen instructions.

The scanned image is saved to a folder, attached to an email, uploaded to a cloud service, and so on depending on the function you selected.

Related Information

- ➔ [“Specifications of Originals and Placing Originals” on page 24](#)
- ➔ [“Document Capture Pro / Document Capture” on page 18](#)
- ➔ [“Setting a Resolution That Suits the Scanning Purpose” on page 55](#)

Scanning Using Document Capture (Mac OS X)

This application allows you to perform various tasks such as saving the image to your computer, sending it by email, printing, and uploading to a server or a cloud service. You can register scanning settings for a job to simplify scanning operations. See the help for details on Document Capture.

Note:

Do not use the Fast User Switching function while using your scanner.

1. Place the original.

Basic Scanning

2. Start Document Capture.

Select **Finder > Go > Applications > Epson Software > Document Capture**.

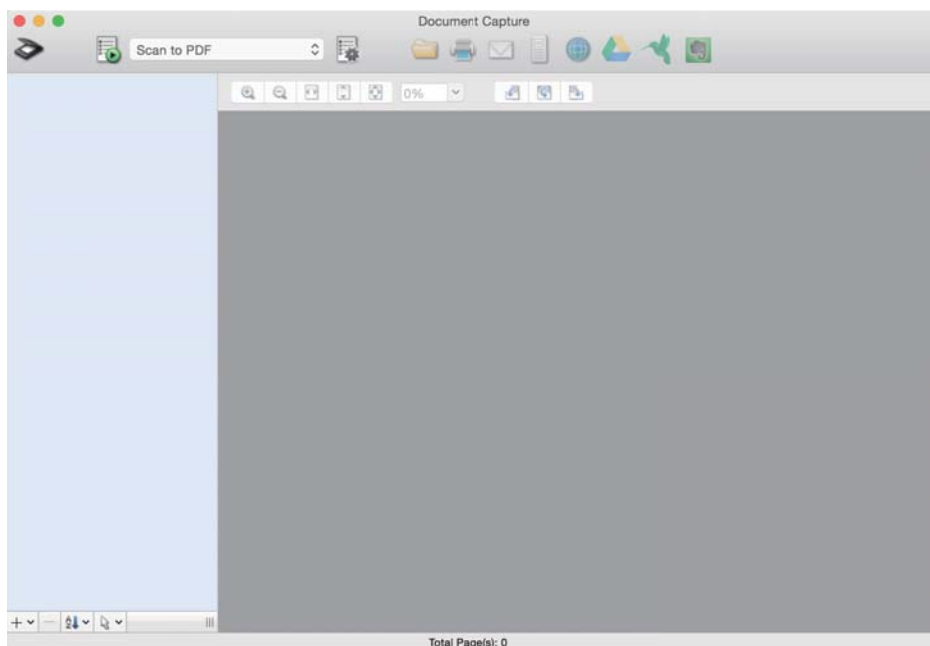

Note:

You may need to select the scanner you want to use from the scanners list.

3. Click .

The **Scan Settings** window is displayed.

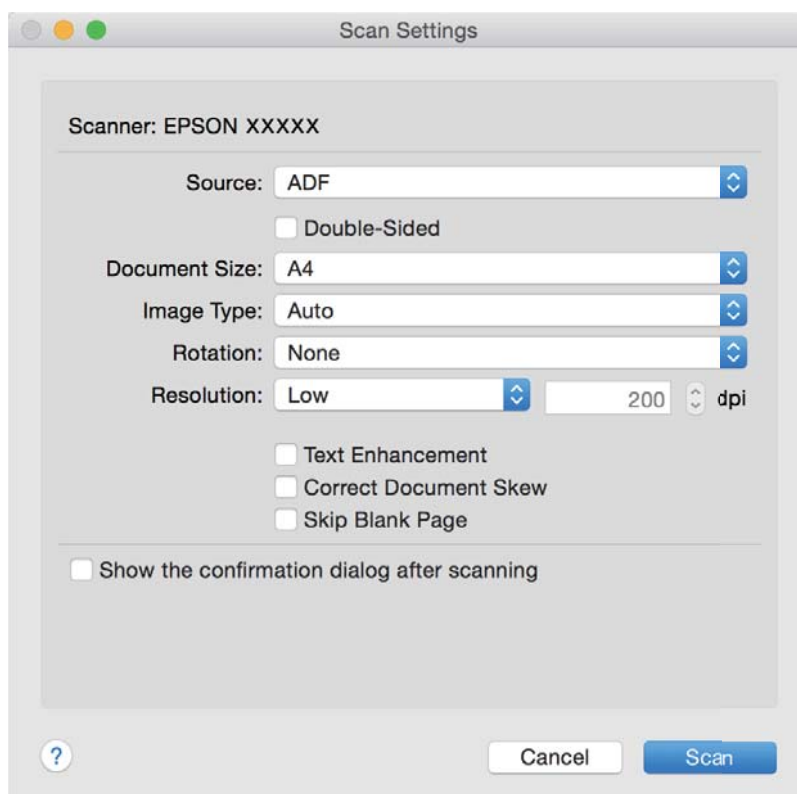

Basic Scanning

4. Make the following settings.

- Source:** Select the source where the original is placed.
- Document Size:** Select the size of the original you placed.
- Image Type:** Select the color you want to use to save the scanned image.
- Rotation:** Select the rotation angle depending on the original you want to scan.
- Resolution:** Select the resolution.

Note:

You can also adjust the image using following items.

- Text Enhancement:** Select to make blurred letters in the original clear and sharp.
- Correct Document Skew:** Select to correct the slant of the original.
- Skip Blank Page:** Select to skip blank pages if there are any in the originals.

5. Make sure the feed selector on the scanner is set correctly.

To scan originals using ADF, set the feed selector to  (ADF). To scan a plastic card using the card slot, set the feed selector to  (card).

6. Click **Scan**.

The scanned document is displayed in Document Capture.

7. Check the scanned images, and edit them if necessary.

8. When you have finished checking the image, click one of the destination icons.

One of the transfer settings windows is displayed depending on the icon you selected.

Note:

- If you want to upload to a cloud service, you need to set up your account with the cloud service in advance.*
- If you want to use Evernote as the destination, download the Evernote application from the Evernote Corporation Website and install it before using this feature.*

9. Make settings for each item in the window, and then click **Send** or **OK**.

10. Follow the on-screen instructions.

The scanned image is saved to a folder, attached to an email, uploaded to a cloud service, and so on depending on the function you selected.

Related Information

- ➔ [“Specifications of Originals and Placing Originals” on page 24](#)
- ➔ [“Document Capture Pro / Document Capture” on page 18](#)
- ➔ [“Setting a Resolution That Suits the Scanning Purpose” on page 55](#)

Scanning Using a Scanner Button

You can scan using the button on your scanner.

Basic Scanning



Note:

- ❑ *Make sure that Epson Scan 2 is installed on your computer and the scanner is connected to your computer correctly.*
- ❑ *When Document Capture Pro (Windows) or Document Capture (Mac OS X) is installed on your computer, you can assign the job to a button on the scanner and run the job by pressing it.*

However, this is not available over a wireless connection.

- ❑ *When using a wireless connection, launch Epson Scan 2 on your computer before scanning.*

1. Place the original.
2. Make sure the feed selector on the scanner is set correctly.

To scan originals using ADF, set the feed selector to  (ADF). To scan a plastic card using the card slot, set the feed selector to  (card).

3. Press the  button.

Note:

*When using Document Capture Pro (Windows) or Document Capture (Mac OS X), the product starts the job that was assigned in the **Job Settings** window.*

Related Information

- ➔ [“Specifications of Originals and Placing Originals” on page 24](#)
- ➔ [“Buttons and Lights” on page 15](#)
- ➔ [“Document Capture Pro / Document Capture” on page 18](#)
- ➔ [“Scanning Using Specified Scanning Settings \(Job\)” on page 77](#)

Advanced Scanning

Scanning Different Sizes or Types of Originals One by One (Automatic Feeding Mode)

You can scan different sizes or types of originals one by one using Automatic Feeding Mode. In this mode, the scanner starts scanning automatically when originals are loaded in the ADF.

You can also use the card slot to scan plastic cards in Automatic Feeding Mode.

1. Start Epson Scan 2.
2. Select **Automatic Feeding Mode** on the **Main Settings** tab.

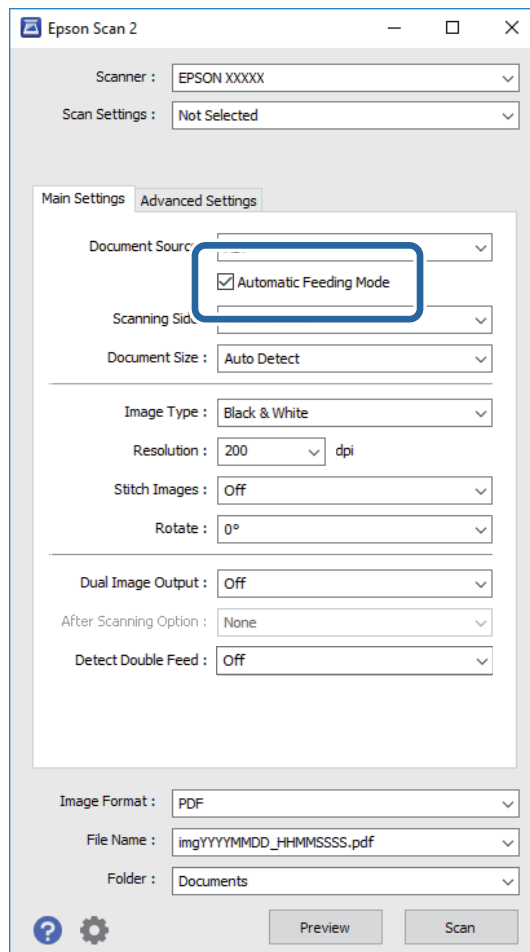

3. Make other settings for scanning on the Epson Scan 2 main window.
4. Click **Scan**.
Automatic Feeding Mode starts.

Advanced Scanning

The  light on the scanner turns on, and the **Automatic Feeding Mode** window is displayed on your computer.

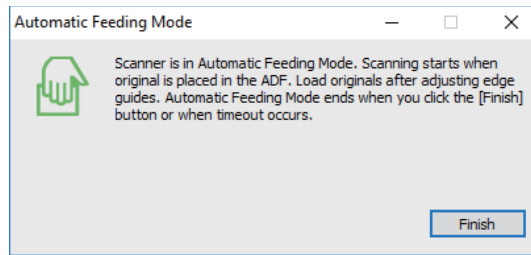

5. Make sure the feed selector on the scanner is set correctly.

To scan originals using ADF, set the feed selector to  (ADF). To scan a plastic card using the card slot, set the feed selector to  (card).

6. Adjust the edge guides, and then place the original in the ADF until it is fed automatically into the ADF. If you want to scan a plastic card, insert the card into the card slot. Scanning starts automatically.
7. After scanning stops, place the next original in the ADF. Repeat this procedure until you have scanned all originals.

Note:

Make sure that the feed selector is set correctly before placing originals.

8. After you have scanned all originals, press the  button on the scanner to close Automatic Feeding Mode.

Note:

- You can also close Automatic Feeding Mode by pressing **Finish** on the **Automatic Feeding Mode** window displayed on your computer.
- You can make timeout settings to finish **Automatic Feeding Mode**.

Select **Settings** on the **Document Source** list to open the **Document Source Settings** window. Set **Automatic Feeding Mode Timeout (minutes)** on the window.

The scanned image is saved to the folder you specified.

Related Information

➔ [“Specifications of Originals and Placing Originals” on page 24](#)

Creating Scanned Images to Suit Your Needs

Image Adjustment Features

You can adjust scanned images using the features on the **Advanced Settings** tab in Epson Scan 2.

Except for a few features, you can check the adjustment results in the preview window.

Advanced Scanning

Note:

Some items may not be available depending on other settings you made.

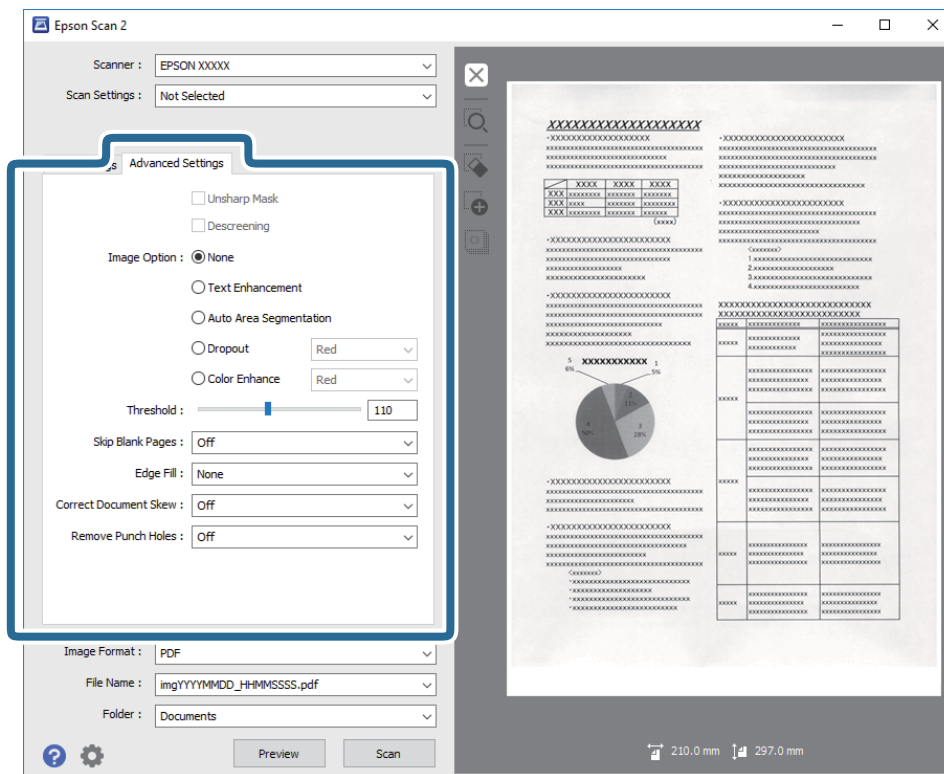
**Related Information**

- ➔ [“Unsharp Mask” on page 66](#)
You can enhance and sharpen the outlines of the image.
- ➔ [“Descreening” on page 66](#)
You can remove moiré patterns (web-like shadows) that appear when scanning printed paper such as a magazine.
- ➔ [“Text Enhancement” on page 67](#)
You can make blurred letters in the original clear and sharp. You can also reduce the offset or unevenness of the background.
- ➔ [“Auto Area Segmentation” on page 67](#)
You can make letters clear and images smooth when performing black and white scanning for a document that contains images.
- ➔ [“Dropout” on page 67](#)
You can remove the color specified from the scanned image, and then save it in grayscale or black and white. For example, you can erase marks or notes you wrote in the margins with color pen when scanning.
- ➔ [“Color Enhance” on page 68](#)
You can enhance the color specified for the scanned image, and then save it in grayscale or black and white. For example, you can enhance letters or lines that are in light colors.
- ➔ [“Brightness” on page 68](#)
You can adjust the brightness for the whole image.
- ➔ [“Contrast” on page 68](#)
You can adjust the contrast for the whole image. If you increase the contrast, the bright areas become brighter, and the dark areas become darker. On the other hand, if you lower the contrast, the differences between the bright and dark areas of the image are less defined.

Advanced Scanning

➔ “Gamma” on page 69

You can adjust the gamma (brightness of the intermediate range) for the whole image. If the image is too light or too dark, you can adjust the brightness.

➔ “Threshold” on page 69

You can adjust the border for monochrome binary (black and white). Increase the threshold, the black color area becomes larger. Decrease the threshold, the white color area becomes larger.

➔ “Skip Blank Pages” on page 69

You can skip blank pages if there are any in the originals.

➔ “Edge Fill” on page 70

You can remove the shadow created around the scanned image.

➔ “Correct Document Skew” on page 70

You can correct the slant of the original.

➔ “Remove Punch Holes” on page 71

You can remove the shadows of holes on the scanned image when scanning originals with punched holes.

Unsharp Mask

You can enhance and sharpen the outlines of the image.



Note:

This feature is not available when selecting the **Main Settings** tab > **Image Type** > **Black & White**.

Descreening

You can remove moiré patterns (web-like shadows) that appear when scanning printed paper such as a magazine.



To check for moiré patterns, display the image at 100 % (1:1). If the displayed image is zoomed out, the image appears rough and may look like it has moiré patterns.

Note:

- To use this feature, set the **Resolution** on the **Main Settings** tab to 600 dpi or less.
- This feature is not available when selecting the **Main Settings** tab > **Image Type** > **Black & White**.
- The effect of this feature cannot be checked in the preview window.
- This feature softens the sharpness of the scanned image.

Advanced Scanning

Image Option

You can select the effect for the scanned image.

Text Enhancement

You can make blurred letters in the original clear and sharp. You can also reduce the offset or unevenness of the background.



You can select the level of the effect when selecting the **Main Settings** tab > **Image Type** > **Color** or **Grayscale**.

Note:

To use this feature, set the **Resolution** on the **Main Settings** tab to 600 dpi or less.

Auto Area Segmentation

You can make letters clear and images smooth when performing black and white scanning for a document that contains images.



You can adjust the quality of the image part of the original from **Brightness** and **Contrast**.

Note:

- You can only make settings for this feature when selecting the **Main Settings** tab > **Image Type** > **Black & White**.
- To use this feature, set the **Resolution** on the **Main Settings** tab to 600 dpi or less.

Dropout

You can remove the color specified from the scanned image, and then save it in grayscale or black and white. For example, you can erase marks or notes you wrote in the margins with color pen when scanning.



Advanced Scanning

If you select **Customize** from the color list in **Dropout**, you can make settings for the color you want to remove while checking the preview window (for Windows only).

Note:

*This feature is not available when selecting the **Main Settings tab > Image Type > Auto or Color.***

Color Enhance

You can enhance the color specified for the scanned image, and then save it in grayscale or black and white. For example, you can enhance letters or lines that are in light colors.



If you select **Customize** from the color list in **Color Enhance**, you can make settings for the color you want to enhance while checking the preview window (for Windows only).

Note:

*This feature is not available when selecting the **Main Settings tab > Image Type > Auto or Color.***

Brightness

You can adjust the brightness for the whole image.



Note:

*This feature is not available depending on the settings on the **Main Settings tab > Image Type** or the settings on the **Advanced Settings tab.***

Contrast

You can adjust the contrast for the whole image. If you increase the contrast, the bright areas become brighter, and the dark areas become darker. On the other hand, if you lower the contrast, the differences between the bright and dark areas of the image are less defined.



Advanced Scanning

Note:

This feature is not available depending on the settings on the **Main Settings** tab > **Image Type** or the settings on the **Advanced Settings** tab.

Gamma

You can adjust the gamma (brightness of the intermediate range) for the whole image. If the image is too light or too dark, you can adjust the brightness.



Note:

This feature is not available depending on the settings on the **Main Settings** tab > **Image Type** or the settings on the **Advanced Settings** tab.

Threshold

You can adjust the border for monochrome binary (black and white). Increase the threshold, the black color area becomes larger. Decrease the threshold, the white color area becomes larger.

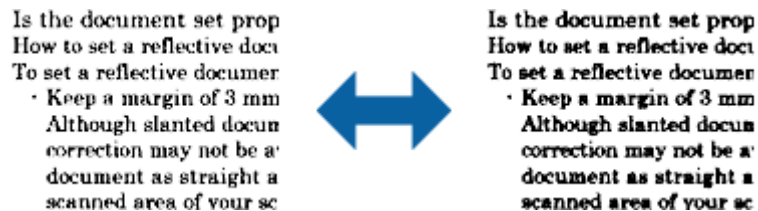

Note:

This feature may not be available depending on the settings on the **Main Settings** tab > **Image Type** or the settings on the **Advanced Settings** tab.

Skip Blank Pages

You can skip blank pages if there are any in the originals.

You can select the amount of blank page detection. If you set this to a high level, you can skip any originals with light colors or offset as blank pages.

If the result is not what you expected, select **Skip Blank Pages** > **Settings**, and then adjust **User Defined Level**. Select again **Skip Blank Pages** > **User Defined Level**.

Note:

- Some pages may be incorrectly skipped as blank pages.
- This feature is not available when scanning double-sided originals that are stitched.

Advanced Scanning

Edge Fill

You can remove the shadow created around the scanned image.



For double-sided scanning, the settings for the edge fill range are mirror-reversed for the back of the original.

If you select **Settings**, the **Edge Fill Level** screen is displayed, and you can adjust the edge fill ranges for the top, bottom, left, and right.

Note:

The effect of this feature cannot be checked in the preview window.

Correct Document Skew

You can correct the slant of the original.



Off

The slant of the original is not corrected.

Paper Skew

Corrects the slant of originals that are fed askew.

Contents Skew

Corrects the slant of the content of the original that was printed at an angle and so on.

Paper and Contents Skew

Corrects the slant of the original that is fed askew as well as the content of the original.

Note:

- When using this feature, areas that are fed askew are corrected using white.
- To use this feature, set the **Resolution** on the **Main Settings** tab to 600 dpi or less.
- This feature may not be able to correct documents that have been over skewed.
- The effect of this feature cannot be checked in the preview window.

Advanced Scanning

Remove Punch Holes

You can remove the shadows of holes on the scanned image when scanning originals with punched holes.

You can remove the shadows of round or square punch holes that are within a range of 20 mm (0.79 in.) from the edges of the original.



Note:

- This feature is only available when you are scanning white or light colored originals.
- Depending on the scanned originals, the shadows of the punch holes may not be removed.
- The effect of this feature cannot be checked in the preview window.

Editing Scanned Pages Using Epson Scan 2

You can edit pages of scanned images using the features on the **Main Settings** tab in Epson Scan 2.

Stitch Images

You can stitch the images on the front and rear when scanning both sides of the original. Select the layout for stitching the images.

Note:

This feature is available when you have selected **Double-Sided** in **Scanning Side**.

Rotate

You can rotate the original clockwise and scan it. Select the rotation angle depending on the original you want to scan.

Note:

If you select **Auto** and scan the original, the image is rotated by detecting the orientation of the text information. However, this may take some time depending on the image size, and so on.

Auto is only available if the EPSON Scan OCR component (Windows) or EPSON Scan 2 OCR component (Mac OS X) is installed.

Saving as a Searchable PDF

You can save the scanned image as a Searchable PDF. This is a PDF in which searchable text data is embedded.

Advanced Scanning

Note:

- Text on the originals is recognized using Optical Character Recognition (OCR), and then embedded in the scanned image.
- This feature is only available when the EPSON Scan OCR component (Windows) or Epson Scan 2 OCR component (Mac OS X) is installed.

1. Place the original.
2. Start Epson Scan 2.
3. Make settings for each item on the **Main Settings** tab.
4. Click **Preview**.
5. Place the ejected original again when using the ADF.
6. Check the preview, and make other settings on the **Advanced Settings** tab if necessary.
7. Select **Searchable PDF** from the **Image Format** list.
8. Select **Options** from the **Image Format** list to open the **Image Format Options** window.
9. Select the **Text** tab on the **Image Format Options** window.
10. Check that the language of the original is selected in the **Text Language** list.
11. Click **OK** to close the **Image Format Options** window.
12. Check the save file name displayed in **File Name**.
13. Select the save folder for the scanned image from the **Folder** list.
14. Click **Scan**.

The scanned image is saved as a Searchable PDF.

Related Information

- ➔ [“Scanning Using Epson Scan 2” on page 52](#)
- ➔ [“Specifications of Originals and Placing Originals” on page 24](#)
- ➔ [“Text is Not Recognized Correctly when Saving as a Searchable PDF” on page 124](#)

Saving as an Office Format File (for Windows Only)

You can save the scanned image as a Microsoft® Office format file using Document Capture Pro.

You can select the following formats.

- Microsoft® Word (.docx)
- Microsoft® Excel® (.xlsx)
- Microsoft® PowerPoint® (.pptx)

Note:

This feature is only available when the EPSON Scan OCR component is installed.

Advanced Scanning

1. Place the original.
2. Start Document Capture Pro.
3. Click  .
The **Scan** window is displayed.
4. Make the scanning settings, and then click **Scan**.
5. Check the scanned images, and edit them if necessary.
6. When you have finished checking the image, click one of the destination icons.

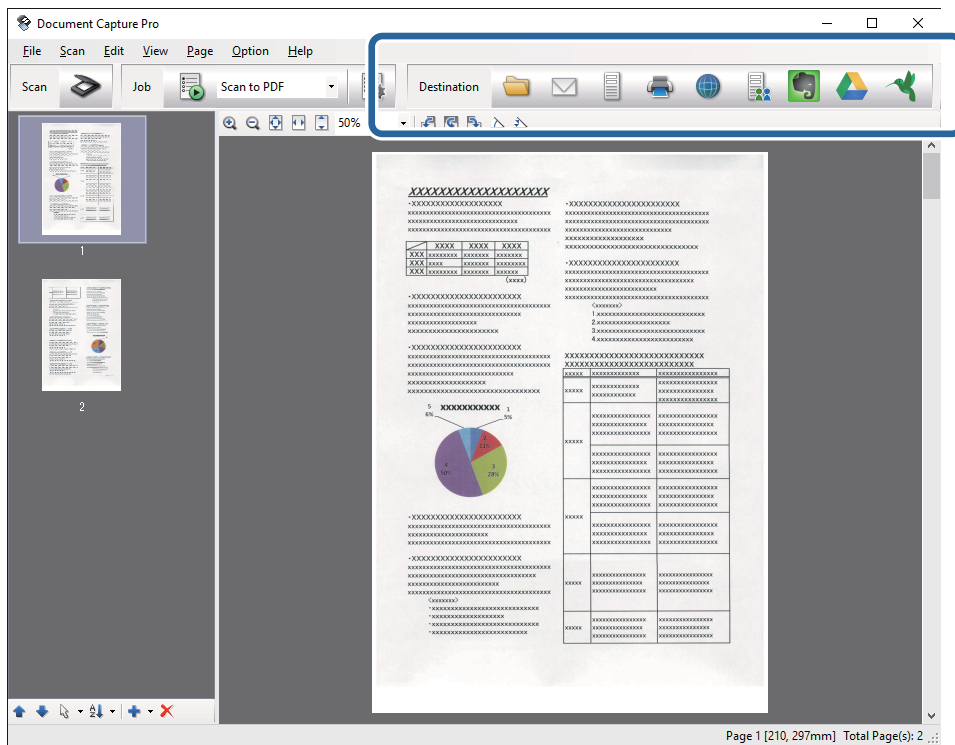

The **Batch Save**, **Transfer Settings**, or another window opens.

7. Select the Office format file you want to save as from the **File Type** list.
8. Click **Options** to display the **Detailed Settings** window.
9. Make settings for each item, and then click **OK** to close the **Detailed Settings** window.
10. Make other settings if necessary, and then click **Send** or **OK**.
The scanned image is saved as an Office format file.

Related Information

- ➔ [“Scanning Using Document Capture Pro \(Windows\)” on page 56](#)
- ➔ [“Specifications of Originals and Placing Originals” on page 24](#)

Various Types of Saving and Transferring

Sorting and Saving Scanned Images into a Separate Folder (for Windows Only)

You can sort scanned images automatically and save them to a separate folder using Document Capture Pro.

To sort scanned images, you can use a variety of detection methods such as blank pages inserted between the originals or barcodes on the originals.

1. Place the originals including indicators, such as blank pages, between the pages where you want to separate the scanned images.
2. Start Document Capture Pro.
3. Click .
The **Scan** window is displayed.
4. Make the scanning settings, and then click **Scan**.
5. Check the scanned images, and edit them if necessary.
6. When you have finished checking the image, select the destination.
The **Batch Save** window or the **Transfer Settings** window is displayed.
7. Click **File Name & Separation Settings**.
8. Select **Apply job separation**, and then click **Separation Settings**.
9. Select the separation method and the method for specifying the folder name on the **Job Separation Settings** window, and then click **OK**.
10. Make other settings on the **File Name & Separation Settings** window, and then click **OK**.
11. Make other settings on the **Batch Save** window or the **Transfer Settings** window, and then click **OK** or **Send**.
Scanned images are saved separately based on the separation method selected.

Related Information

- ➔ [“Scanning Using Document Capture Pro \(Windows\)” on page 56](#)
- ➔ [“Specifications of Originals and Placing Originals” on page 24](#)

Scanning to a Cloud Service

You can upload scanned images to cloud services using Document Capture Pro (Windows) or Document Capture (Mac OS X).

Advanced Scanning

Note:

- ❑ Create a cloud service account before using this function.
- ❑ If you want to use Evernote as the destination, download the Evernote application from the Evernote Corporation Website, and then install it before using this feature.

1. Place the original.
2. Start Document Capture Pro (Windows) or Document Capture (Mac OS X).
3. Click  .
The **Scan** window is displayed.
4. Make the scanning settings, and then click **Scan**.
5. Check the scanned images, and edit them if necessary.
6. When you have finished checking the image, click the destination icon.

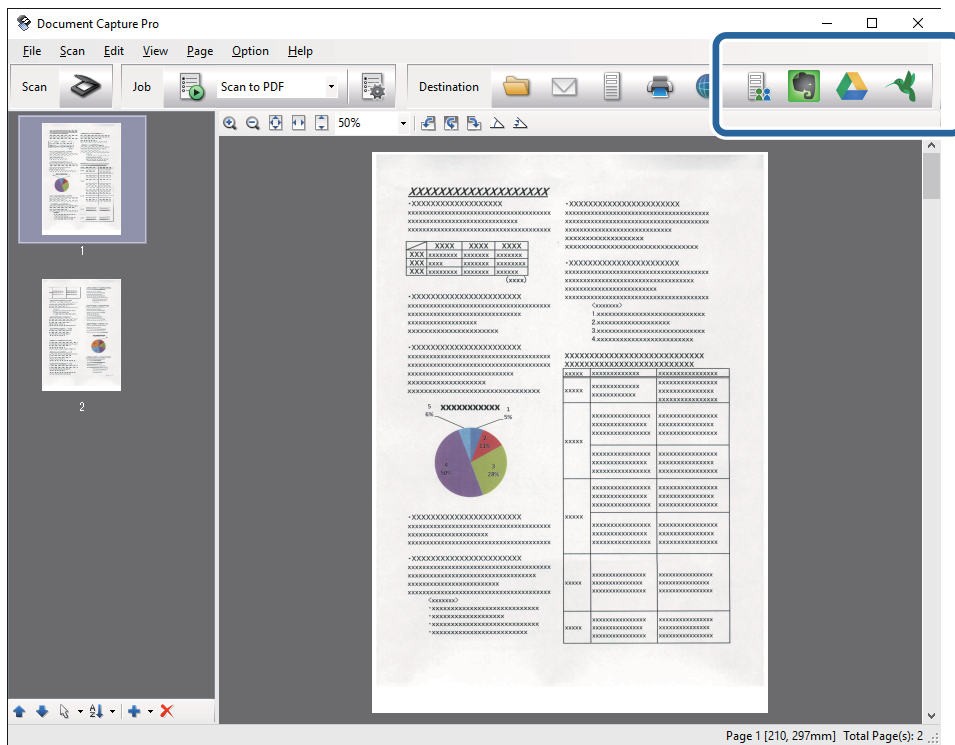

The **Transfer Settings** window is displayed.

7. Make settings for each item, and then click **Send**.
The scanned Image is sent to the selected cloud service.



Related Information

- ➔ [“Scanning Using Document Capture Pro \(Windows\)” on page 56](#)
- ➔ [“Scanning Using Document Capture \(Mac OS X\)” on page 59](#)
- ➔ [“Specifications of Originals and Placing Originals” on page 24](#)

Advanced Scanning

Uploading to an FTP Server

You can upload scanned images to an FTP server using Document Capture Pro (Windows) or Document Capture (Mac OS X).

1. Place the original.
2. Start Document Capture Pro (Windows) or Document Capture (Mac OS X).
3. Click .
The **Scan** window is displayed.
4. Make the scanning settings, and then click **Scan**.
5. Check the scanned images, and edit them if necessary.
6. When you have finished checking the image, click the  icon.
The **Transfer Settings** window is displayed.
7. Make settings for each item, and then click **Send**.

Note:

Contact your network administrator for the settings of your FTP server.



The scanned image is sent to your FTP server.

Related Information

- ➔ [“Scanning Using Document Capture Pro \(Windows\)” on page 56](#)
- ➔ [“Scanning Using Document Capture \(Mac OS X\)” on page 59](#)
- ➔ [“Specifications of Originals and Placing Originals” on page 24](#)

Attaching Scanned Images to an Email

You can attach scanned images directly to an email using Document Capture Pro (Windows) or Document Capture (Mac OS X).

1. Place the original.
2. Start Document Capture Pro (Windows) or Document Capture (Mac OS X).
3. Click .
The **Scan** window is displayed.
4. Make the scanning settings, and then click **Scan**.
5. Check the scanned images, and edit them if necessary.
6. When you have finished checking the image, click the  icon.
The **Batch Save** window is displayed.

Advanced Scanning

7. Make settings for each item, and then click **OK**.

The email client on your computer starts automatically, and the scanned image is attached to an email.

Related Information

- ➔ [“Scanning Using Document Capture Pro \(Windows\)” on page 56](#)
- ➔ [“Scanning Using Document Capture \(Mac OS X\)” on page 59](#)
- ➔ [“Specifications of Originals and Placing Originals” on page 24](#)



Printing Scanned Images

You can print scanned images directly from an Epson printer connected to the computer.

Note:

Before using this feature, check the following.

- The Epson printer is connected to the same computer to which the scanner is connected.
- The printer driver is correctly installed on the computer.

1. Place the original.
2. Start Document Capture Pro (Windows) or Document Capture (Mac OS X).
3. Click .
The **Scan** window is displayed.
4. Make the scanning settings, and then click **Scan**.
5. Check the scanned images, and edit them if necessary.
6. When you have finished checking the image, click the  icon.
The **Print Settings** window opens.
7. Make settings for each item, and then click **OK**.
The scanned image is printed from the printer.

Related Information

- ➔ [“Scanning Using Document Capture Pro \(Windows\)” on page 56](#)
- ➔ [“Scanning Using Document Capture \(Mac OS X\)” on page 59](#)
- ➔ [“Specifications of Originals and Placing Originals” on page 24](#)

Scanning Using Specified Scanning Settings (Job)

You can create a "Job" which is a set of specified scanning settings such as the sorting method, saving format, destination, and so on.

You can set the job in Document Capture Pro (Windows) or Document Capture (Mac OS X).

Advanced Scanning

You can also assign the job to a button on the scanner, and run the job by pressing it. (Only when using a USB connection.)

Note:



Document Capture Pro and Document Capture do not support scanning from the button over a wireless connection.

Setting a Job

1. Start Document Capture Pro (Windows) or Document Capture (Mac OS X).
2. Click the  (**Manage Job**) icon on the main window.
The **Job Management** window is displayed.
3. On the **Job Management** window, click **Add** (Windows) or the + icon (Mac OS X).
The **Job Settings** window opens.
4. Make the job settings on the **Job Settings** window.
 - Job Name:** Enter a name for the job.
 - Scan** tab: Set scanning settings on the tab.
 - Output** tab: Set the output format of the scanned image on the tab.
 - Destination:** Select the destination of the scanned image.
5. Click **OK** to close the **Job Settings** window.
6. Click **OK** on the **Job Management** window.
The job is set in the Document Capture Pro or Document Capture.

Assigning a Job to the Scanner Button

You can assign a job to the scanner's button, and run the job by pressing the button.

1. Start Document Capture Pro (Windows) or Document Capture (Mac OS X).
2. Click the  (**Manage Job**) icon on the main window.
The **Job Management** window is displayed.
3. Click **Event Settings** on the **Job Management** window (Windows), or click the  icon at the bottom of the screen (Mac OS X).
4. Click the job name to select the job you want to assign from the pull-down menu.
5. Click **OK** on the **Job Management** window.
The job is assigned to the scanner button.

Related Information

➔ [“Buttons and Lights” on page 15](#)

Advanced Scanning

- ➔ “Scanning Using a Scanner Button” on page 61
- ➔ “Specifications of Originals and Placing Originals” on page 24

Scanning Business Cards Using Presto! BizCard

You can scan business cards and convert them to editable text using Presto! BizCard.

See the software’s help for more information on using the software and its functions. To display the help, select it from the software’s help menu.

1. Place the business card on the scanner.
2. Start Presto! BizCard.
 - Windows 10
Click the start button, and then select **All apps > NewSoft > Presto! BizCard**.
 - Windows 8.1/Windows 8
Enter the application name in the search charm, and then select the displayed icon.
 - Windows 7/Windows Vista/Windows XP
Click the start button, and then select **All Programs or Programs > NewSoft > Presto! BizCard**.
 - Mac OS X
Select **Go > Applications > Presto! BizCard**.

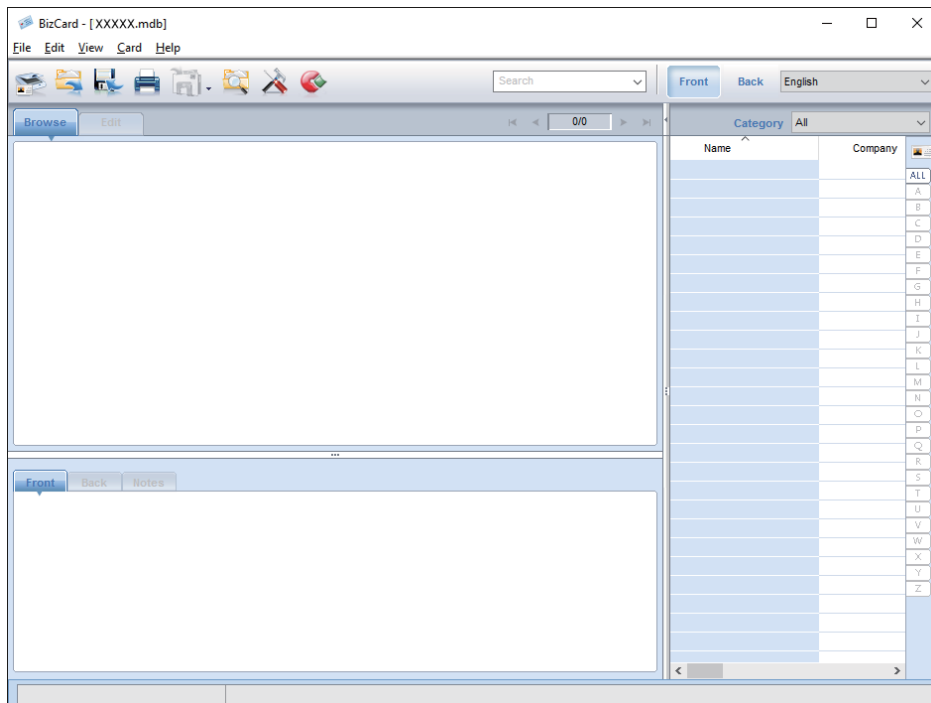

3. Click the  icon at the top-left of the window.
The Epson Scan 2 window opens.

Advanced Scanning

4. Set each item on the Epson Scan 2 window, and then scan.

The business card is scanned and converted into editable text in the Presto! BizCard window.

Related Information

- ➔ [“Presto! BizCard” on page 18](#)
- ➔ [“Specifications of Originals and Placing Originals” on page 24](#)

Network Settings

Network Connection Types

Wi-Fi Connection

Connect the scanner and the computer or smart device to the access point. This is the typical connection method for home or office networks where computers are connected by Wi-Fi through the access point.

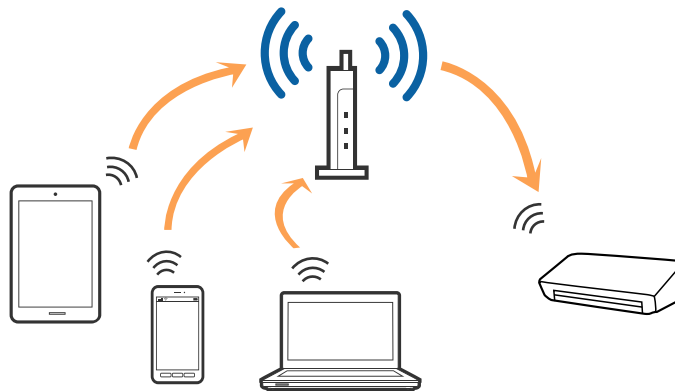

Related Information

- ➔ [“Connecting to a Computer” on page 82](#)
- ➔ [“Connecting to a Smart Device” on page 84](#)
- ➔ [“Making Wi-Fi Settings from the Control Panel” on page 84](#)

AP Mode Connection

Use this connection method when you are not using Wi-Fi at home or at the office, or when you want to connect the scanner and the smart device directly. In this mode, the scanner acts as an access point and you can connect up to four devices to the scanner without having to use a standard access point. However, devices directly connected to the scanner cannot communicate with each other through the scanner.

Network Settings

Note:

AP mode is a connection method designed to replace Ad Hoc mode.

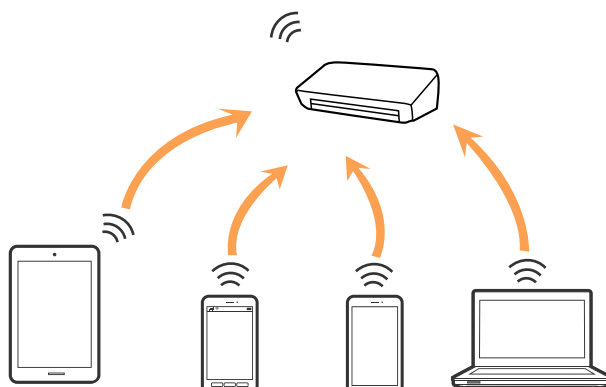
**Related Information**

- ➔ “Making AP Mode Settings” on page 93
- ➔ “Making AP Mode Settings Using Push Button” on page 95

Connecting to a Computer

We recommend using the installer to connect the scanner to a computer. You can run the installer using one of the following methods.

- Setting up from the website

Access the following website, and then enter the product name.

<http://epson.sn>

Go to **Setup**, and then click **Download** in the download and connect part. Click or double-click the downloaded file to run the installer. Follow the on-screen instructions.

- Setting up using the software disc (only for the models that come with a software disc and users with computers with disc drives.)

Insert the software disc into the computer, and then follow the on-screen instructions.

Selecting the Connection Methods

Follow the on-screen instructions until the following screen is displayed and then select the connection method of the scanner to the computer.

Network Settings

Windows

Select the connection type and then click **Next**.

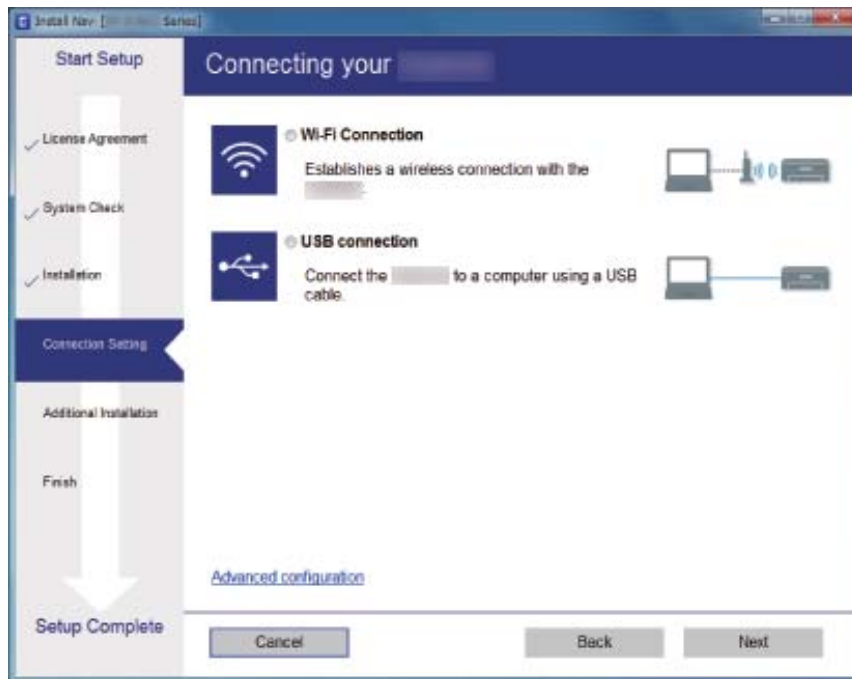

Mac OS X

Select the connection type.



Follow the on-screen instructions. The necessary software is installed.

Connecting to a Smart Device

You can use the scanner from a smart device when you connect the scanner to the same Wi-Fi network (SSID) as the smart device. To use the scanner from a smart device, set up from Epson DocumentScan.

Note:

- If you want to connect a computer and a smart device to the scanner at the same time, we recommend connecting the computer first.
- You can install Epson DocumentScan from App Store or Google Play.

Making Wi-Fi Settings from the Control Panel

You can make network settings from the scanner's control panel. After connecting the scanner to the network, connect to the scanner from the device that you want to use (computer, smart phone, tablet, and so on.)

Making Wi-Fi Settings by Push Button Setup

You can automatically set up a Wi-Fi network by pressing a button on the access point. If the following conditions are met, you can set up by using this method.

- The access point is compatible with WPS (Wi-Fi Protected Setup).
- The current Wi-Fi connection was established by pressing a button on the access point.

Note:

If you cannot find the button or you are setting up using the software, see the documentation provided with the access point.

1. Set the connection mode switch on the scanner to .

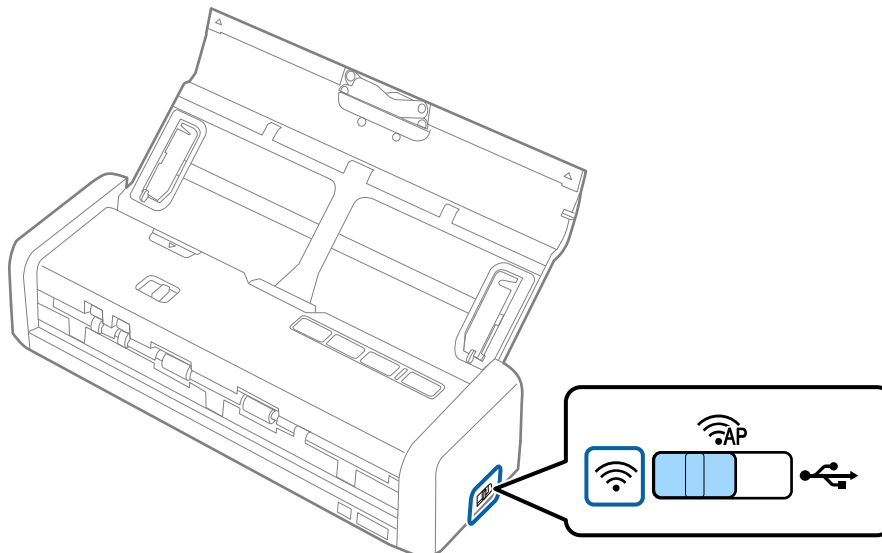

Network Settings

2. Turn on the scanner.

You need to wait until Ready and  lights on the scanner flash simultaneously.

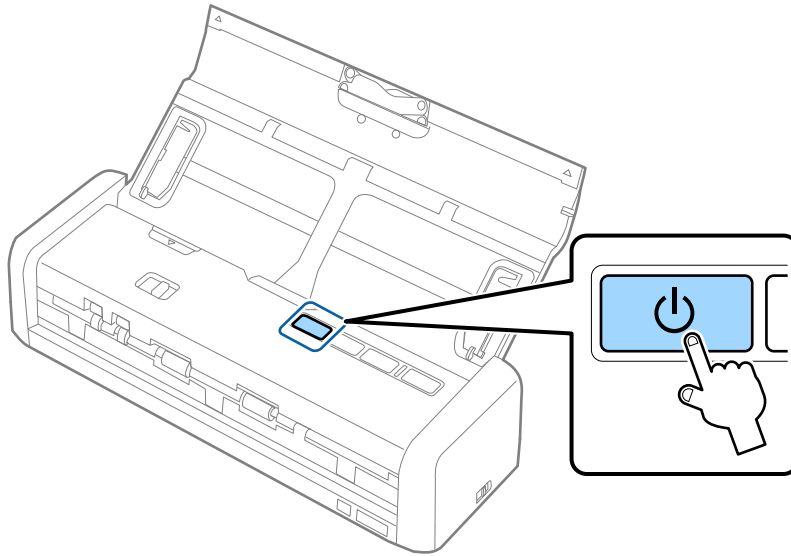

3. Hold down the  button on the scanner for at least three seconds.

You need to wait until the Ready and  lights on the scanner flash alternately.

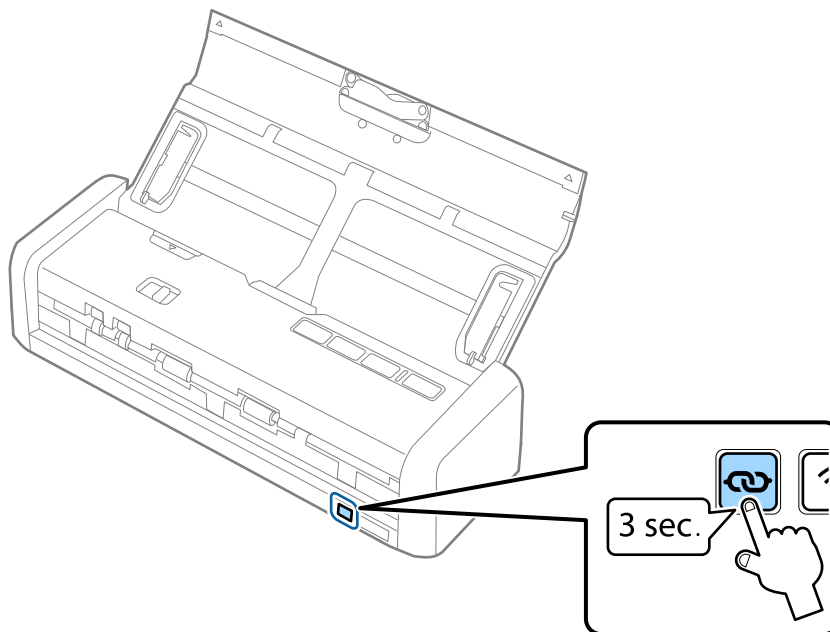

Network Settings

4. Hold down the [WPS] button on the access point until the security light flashes.



When the Ready and  lights on the scanner stay on, the connection has been established. It may take a few minutes.

Note:

- If you do not know where the [WPS] button is, or there are no buttons on the access point, see the documentation provided with your access point for details.
- Connection fails when the  light turns on. Restart the scanner and access point, move them closer together, and then try the network settings again.

Related Information

- ➔ [“Basic Scanning” on page 52](#)
- ➔ [“Advanced Scanning” on page 63](#)
- ➔ [“Network Problems” on page 125](#)

Making Wi-Fi Settings by PIN Code Setup (WPS)

You can connect to an access point by using a PIN code. You can use this method to set up if an access point is capable of WPS (Wi-Fi Protected Setup). Use a computer to enter a PIN code into the access point.

Network Settings

1. Set the connection mode switch on the scanner to .

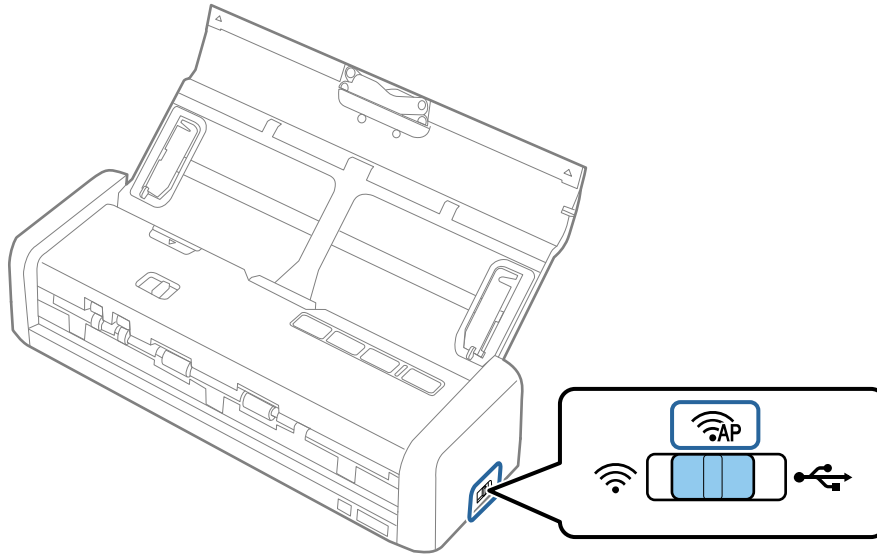

Note:

Even though the PIN code method sets up the scanner for Wi-Fi network, you need to set the connection mode switch to  in this step.

2. Hold down the  button on the scanner and turn it on.

Continue holding down the  button until the Ready and  lights on the scanner flash alternately.

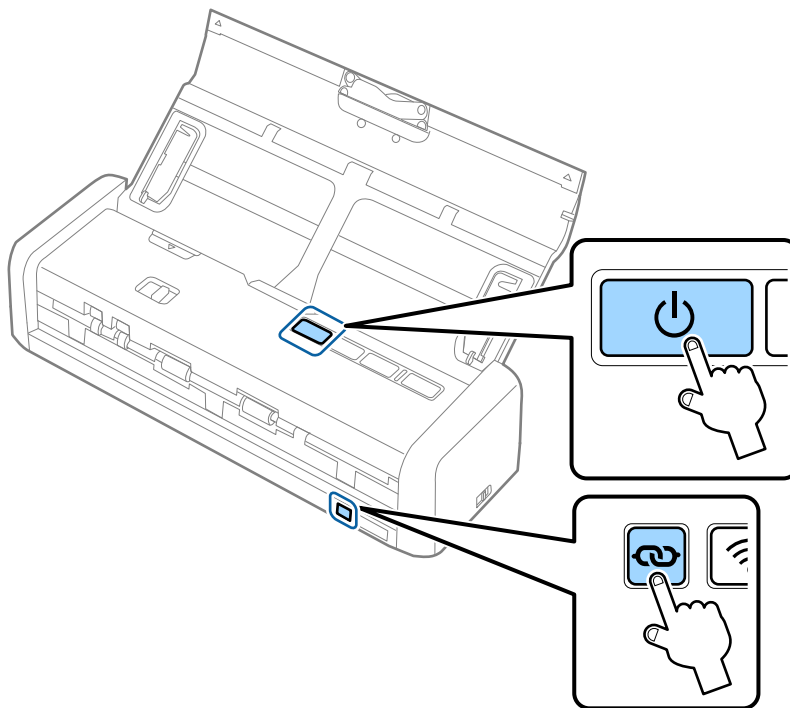

3. Use your computer to enter the PIN code (an eight-digit number) on the label stuck to the bottom face of the scanner into the access point within two minutes.

When the Ready and  lights on the scanner stay on, Wi-Fi setup for the scanner is complete.

Network Settings

Note:

See the documentation provided with the access point for details on entering a PIN code.

4. Turn off the scanner.

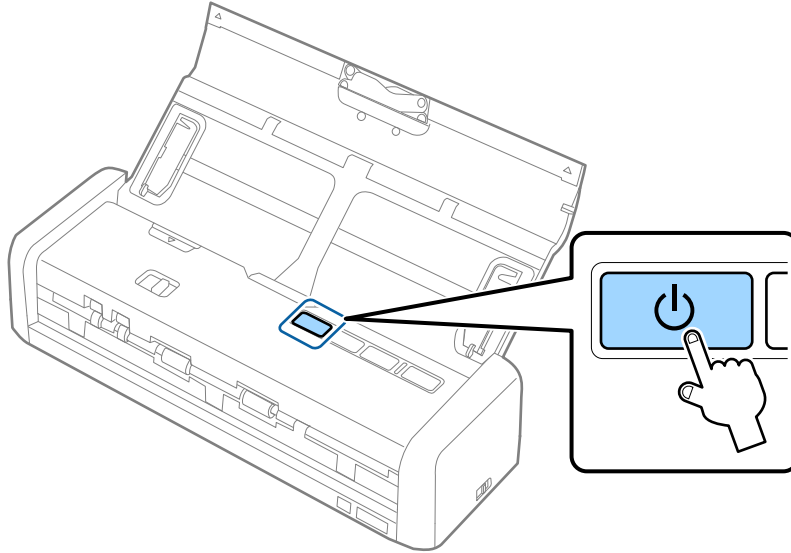

5. Set the connection mode switch on the scanner to , and then turn on the scanner.

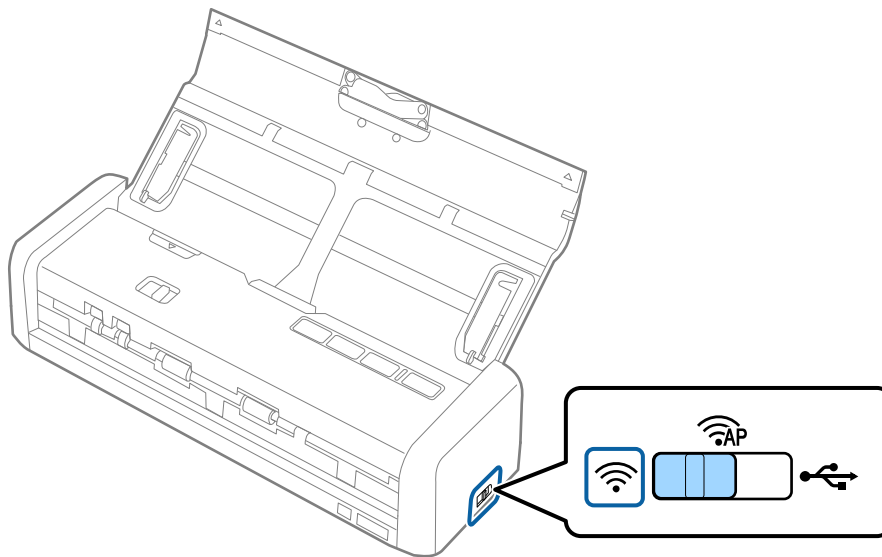

When the Ready and  lights on the scanner stay on, the connection has been established.

Note:

Connection fails when the  light turns on. Restart the scanner and access point, move them closer together, and then try the network settings again.

Related Information

- ➔ [“Basic Scanning” on page 52](#)
- ➔ [“Advanced Scanning” on page 63](#)
- ➔ [“Network Problems” on page 125](#)

Making Wi-Fi Settings by Using EpsonNet Config

You can use EpsonNet Config to connect the scanner to a Wi-Fi network. Connect the scanner to your computer using a AP mode first to register the Wi-Fi network settings on the scanner. Next, reboot the scanner in Wi-Fi connection mode to connect it to your Wi-Fi network.

Check the following settings before you start.

- EpsonNet Config is installed on your computer. If it is not installed, install it from the software disc or download it from the following web site.

<http://epson.sn> > **Setup** > **Download**

- The scanner and your computer are turned on and connected with AP mode connection.

Note:

If you are using iOS or Android devices, you can use Epson DocumentScan to connect the scanner on Wi-Fi network.

1. Run EpsonNet Config on your computer.

- Windows 10

Click the start button, and then select **All apps** > **EpsonNet** > **EpsonNet Config VX** > **EpsonNet Config**.

- Windows 8.1/Windows 8/Windows Server 2012 R2/Windows Server 2012

Enter the application name in the search charm, and then select the displayed icon.

- Windows 7/Windows Vista/Windows XP/Windows Server 2008 R2/Windows Server 2008/Windows Server 2003 R2/Windows Server 2003

Click the start button, and then select **All Programs** (or **Programs**) > **EpsonNet** > **EpsonNet Config VX** > **EpsonNet Config**.

- Mac OS X

Select **Go** > **Applications** > **EPSON Software** > **EpsonNet** > **EpsonNet Config VX** > **EpsonNet Config**.

Note:

Where "X" is the software version.

Network Settings

2. Select your scanner from the list, and then click **Configuration**.

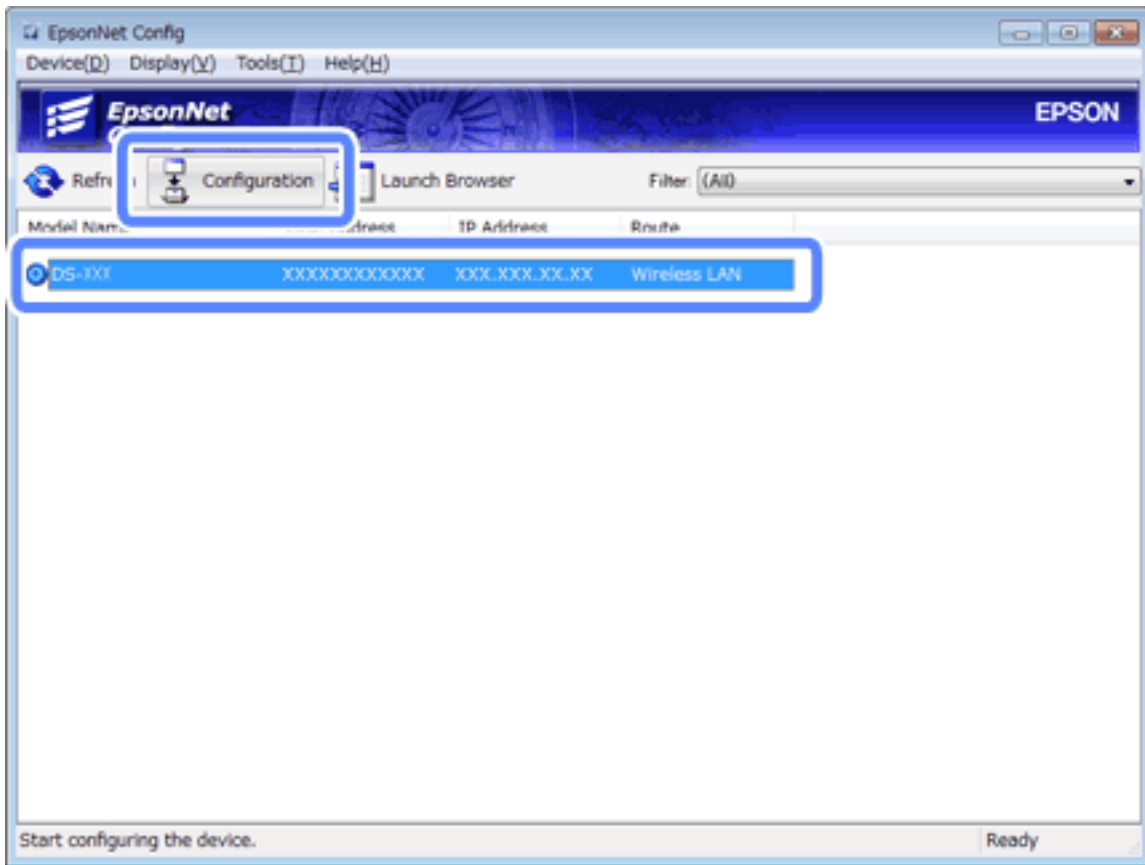

3. Select **Network Interface > Network > Basic (Wireless)**.

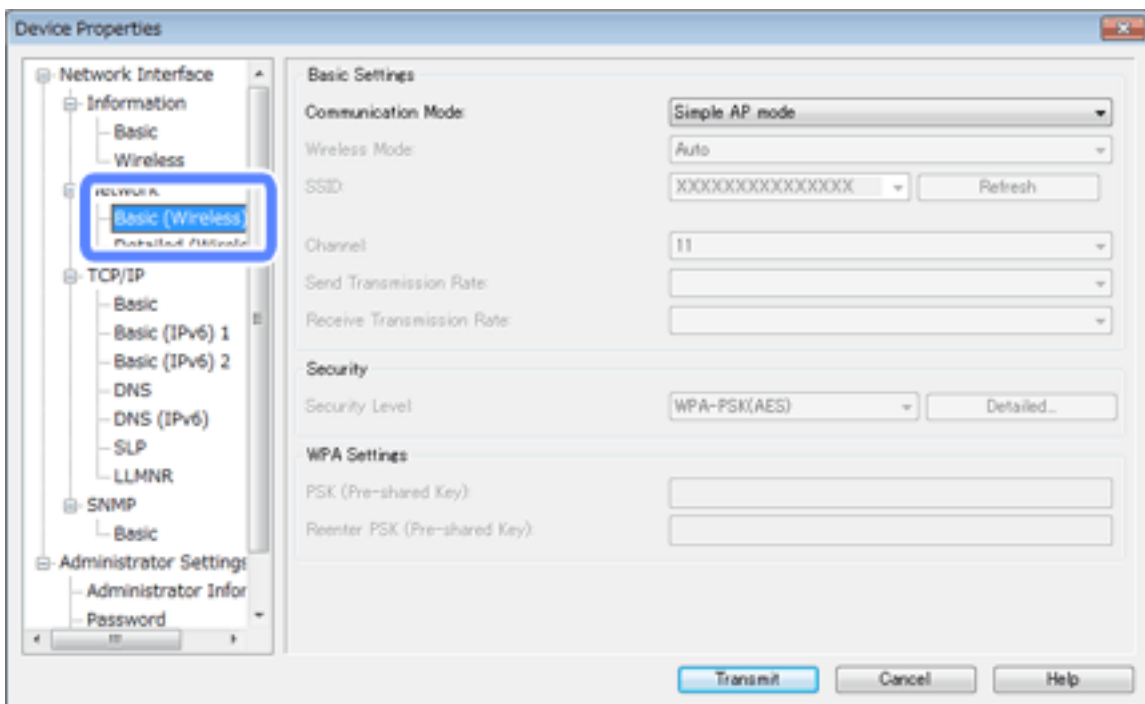

Network Settings

4. Make the necessary settings for your Wi-Fi connection.

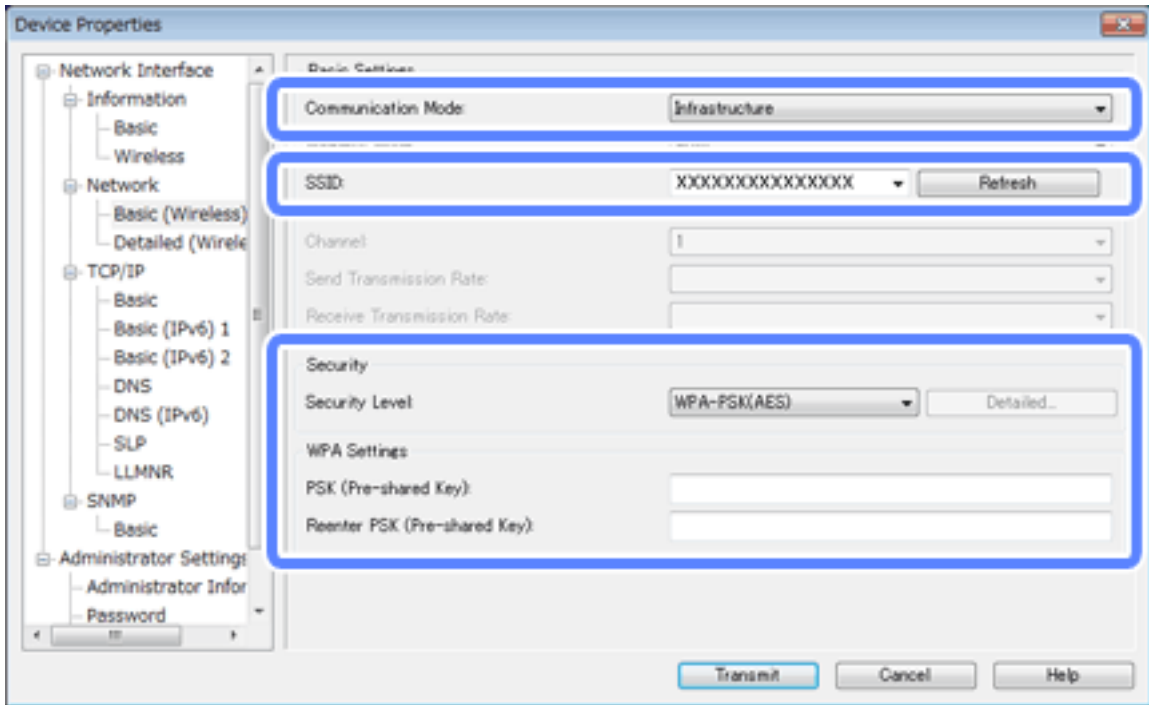

Item	Settings
Communication Mode	Set to Infrastructure
SSID	Set the SSID of the access point you want to connect to.
Security Level	Set the security level of your wireless connection.
WEP Settings WPA Settings	Set the password of your wireless connection.

Note:

- ❑ Make additional settings if necessary.
- ❑ If you do not know the security settings for the access point, see the documentation provided with the access point or contact your network administrator.

5. Click **Transmit**.
6. Quit EpsonNet Config.
Click **Device**, and then click **Quit**.

Network Settings

7. Turn off the scanner.

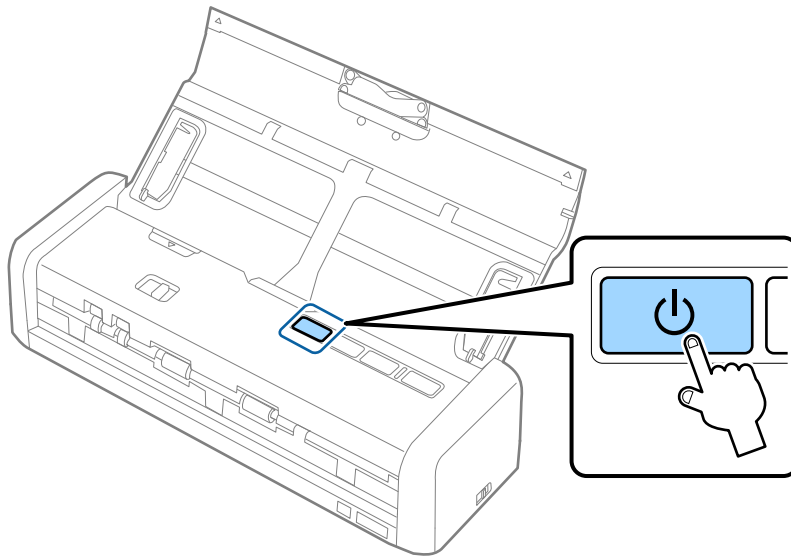

8. Connect your computer to your Wi-Fi network.

9. Set the connection mode switch on the scanner to .

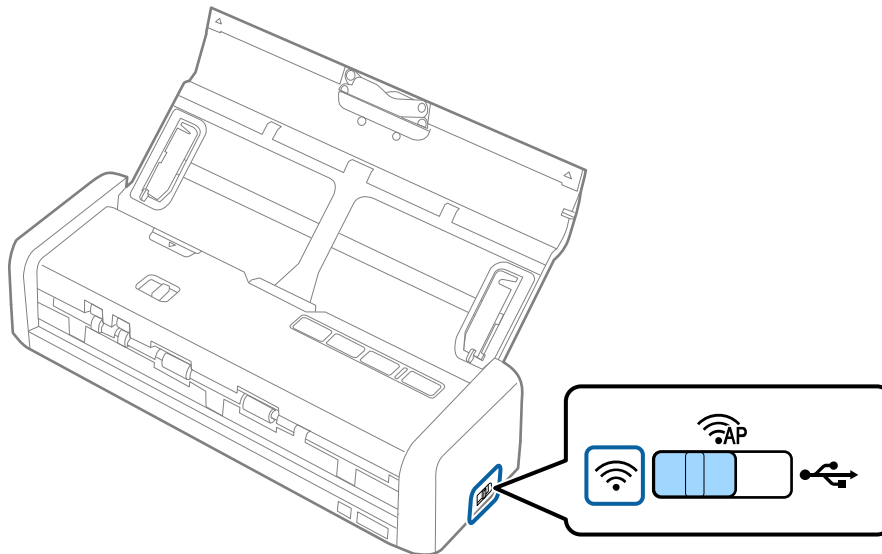

Network Settings

10. Turn on the scanner.

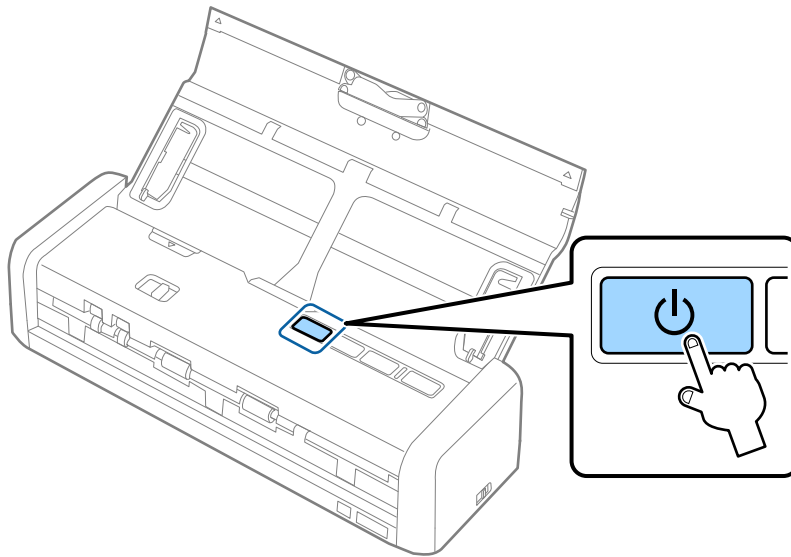

When the Ready and  lights on the scanner stay on, the connection has been established.

Related Information

- ➔ [“Making AP Mode Settings” on page 93](#)
- ➔ [“Basic Scanning” on page 52](#)
- ➔ [“Advanced Scanning” on page 63](#)
- ➔ [“Network Problems” on page 125](#)

Making AP Mode Settings

This method allows you to connect the scanner directly to devices without an access point. The scanner acts as an access point.

Important:

When you connect from a computer or smart device to the scanner using the AP mode connection, the scanner is connected to the same Wi-Fi network (SSID) as the computer or smart device and communication is established between them. Since the computer or smart device is automatically connected to other connectable Wi-Fi networks if the scanner is turned off, it is not connected to the previous Wi-Fi network again if the scanner is turned on. Connect to the scanner's SSID in AP mode from the computer or smart device again. If you do not want to connect every time you turn the scanner on or off, we recommend using a Wi-Fi network by connecting the scanner to an access point.

Network Settings

1. Set the connection mode switch on the scanner to .

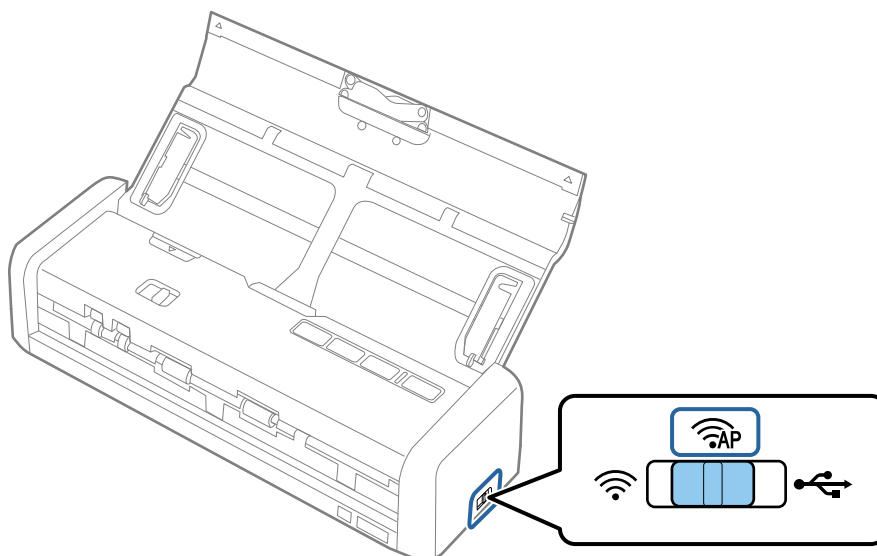

2. Turn on the scanner.

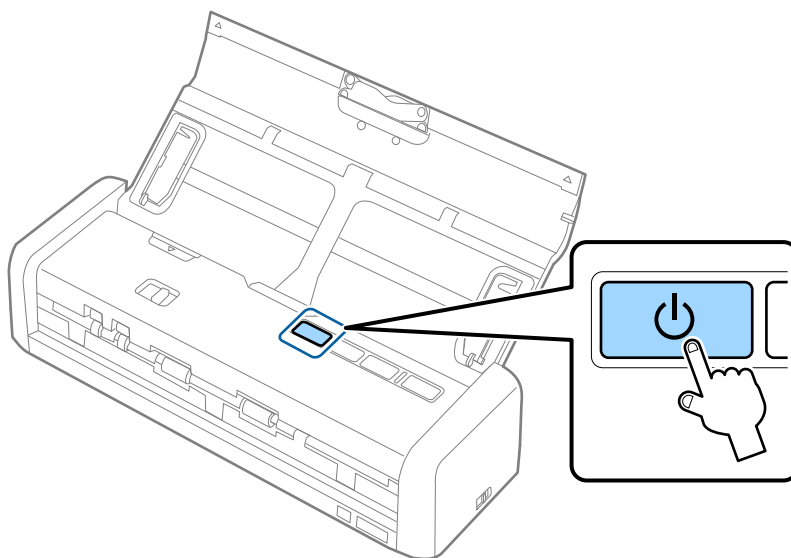

You need to wait until the Ready and  lights stay on.

3. Connect from the smart device or computer to the scanner using the scanner's SSID and password.

Note:

- You can check the SSID and password on the label stuck to the bottom face of the scanner.
- See the documentation provided with your smart device or computer for the operating instructions.

Related Information

- ➔ [“Basic Scanning” on page 52](#)
- ➔ [“Advanced Scanning” on page 63](#)
- ➔ [“Network Problems” on page 125](#)

Network Settings

Making AP Mode Settings Using Push Button

You can setup AP mode by pushing the WPS push button or by using the WPS function if your device supports this method.

Note:

- ❑ Before connecting the scanner to the network, check that your device supports the WPS function.
- ❑ See the documentation provided with your smart device or computer for the operating instructions.

1. Set the connection mode switch on the scanner to .

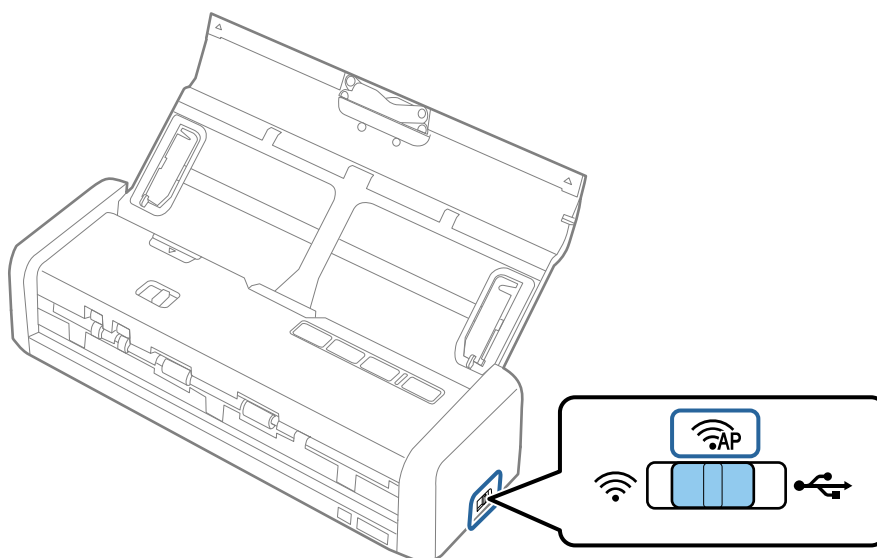

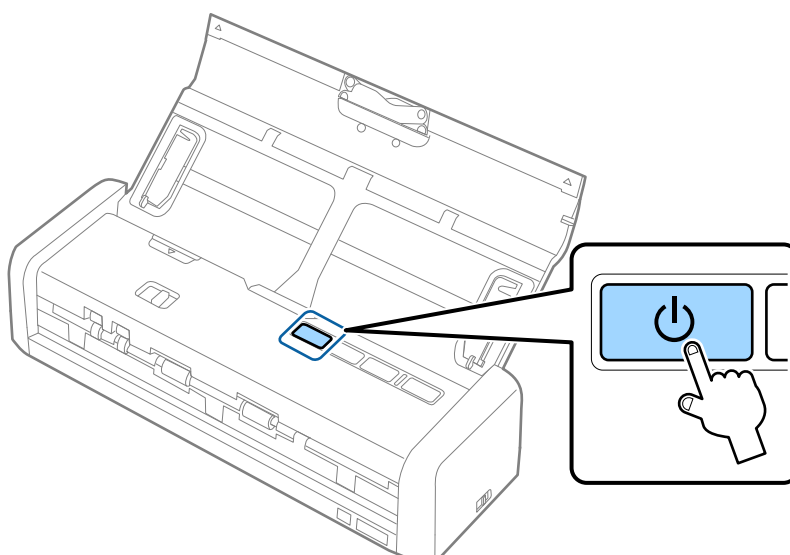

2. Turn on the scanner.



You need to wait until the Ready and  lights stay on.

Network Settings

3. Hold down the  button on the scanner for at least three seconds until the Ready and  lights on the scanner flash alternately.

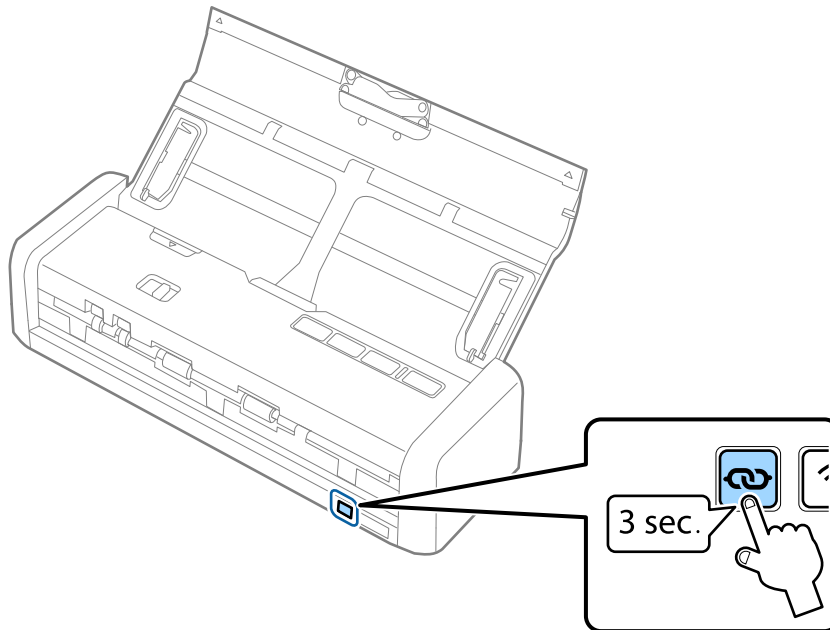

The scanner enters standby status for WPS connection for two minutes, and the Ready and  lights stay on.

4. On the device you want to connect the scanner to, press the WPS button or start the WPS function.
You need to finish this step within approximately two minutes. Otherwise, the standby status for WPS connection is cancelled.

Note:

See the documentation provided with your smart device or computer for the operating instructions.

Related Information

- ➔ [“Basic Scanning” on page 52](#)
- ➔ [“Advanced Scanning” on page 63](#)
- ➔ [“Network Problems” on page 125](#)

Checking the Network Status Using Network Light

You can check the network connection status using the network light on the scanner's control panel.

Related Information

- ➔ [“Buttons and Lights” on page 15](#)
- ➔ [“Error Indicators” on page 16](#)

Replacing or Adding New Access Points

If the SSID changes due to the replacement of an access point, or an access point is added and a new network environment is established, re-set the Wi-Fi settings.

Related Information

➔ “Changing the Connection Method to a Computer” on page 97

Changing the Connection Method to a Computer

Using the installer and re-set up in a different connection method.

- Setting up from the website

Access the following website, and then enter the product name.

<http://epson.sn>

Go to **Setup**, and then click **Download** in the download and connect part. Click or double-click the downloaded file to run the installer. Follow the on-screen instructions.

- Setting up using the software disc (only for the models that come with a software disc and users with computers with disc drives.)

Insert the software disc into the computer, and then follow the on-screen instructions.

Selecting Change the Connection Methods

Follow the on-screen instructions until the following screen is displayed.

- Windows

Select **Change or re-set the connection method** on the Select Software Installation screen, and then click **Next**.

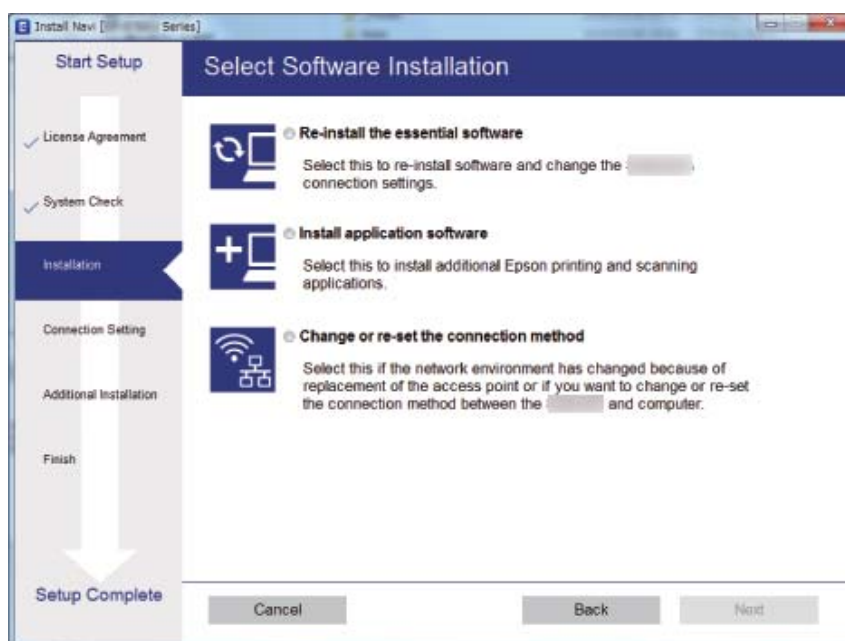

Network Settings

Mac OS X

Select how you want to connect the scanner to your computer.



Restoring the Network Settings from the Control Panel

You can restore all network settings to their defaults.

1. Set the connection mode switch on the scanner to .

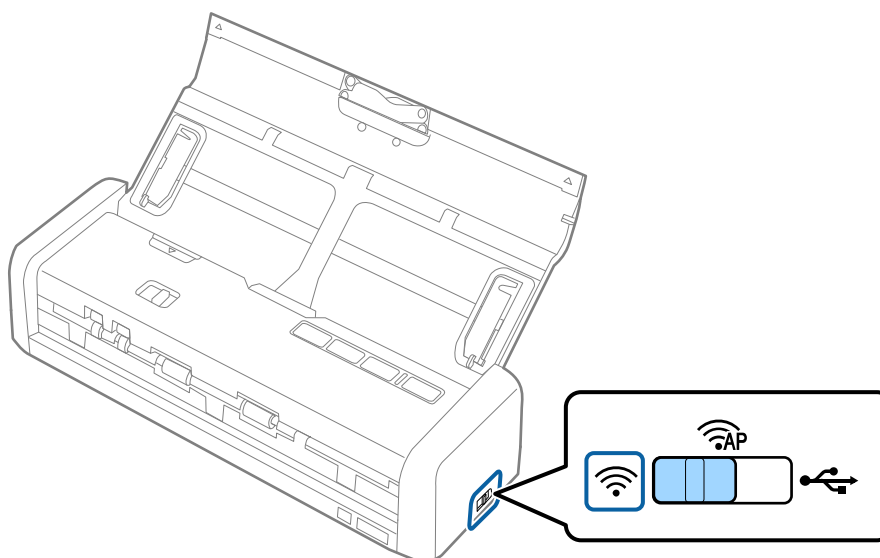

Network Settings

2. Hold down the  button on the scanner and turn it on.

Continue holding down the  button until the Ready and  lights on the scanner flash alternately.

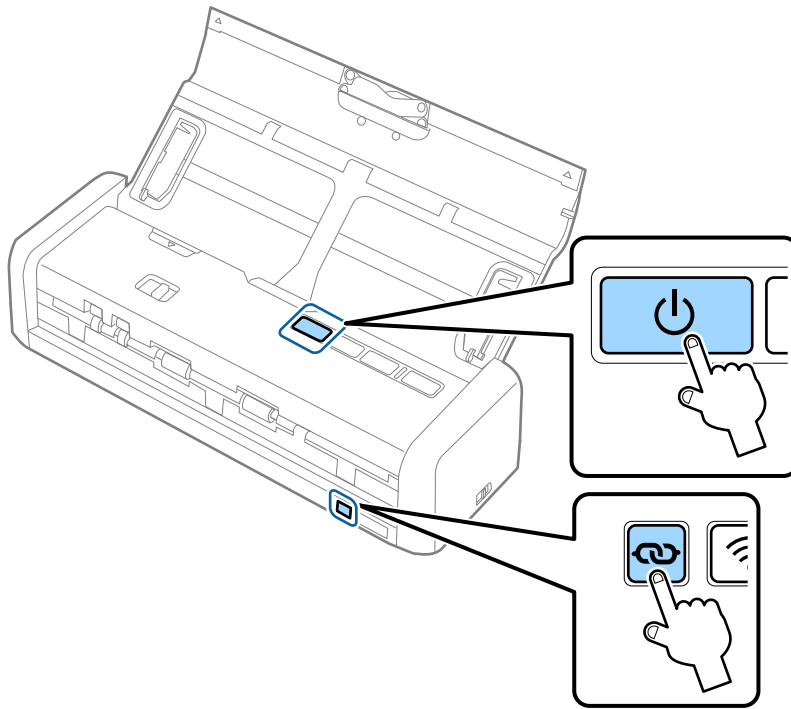

3. Turn off the scanner.

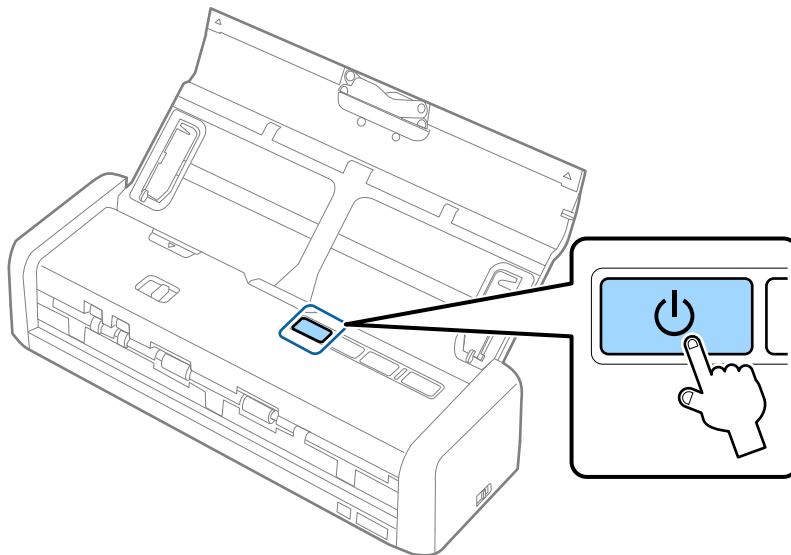

Maintenance

Cleaning Outside the Scanner

Wipe off any stains on the outer case with a dry cloth or a cloth dampened with mild detergent and water.

**Important:**

- Never use alcohol, thinner, or any corrosive solvent to clean the scanner. Deformation or discoloration may occur.*
- Do not let water get inside the product. This could cause a malfunction to occur.*
- Never open the scanner case.*

1. Press the  button to turn off the scanner.
2. Unplug the AC adapter from the scanner.
3. Clean the outer case with a cloth dampened with mild detergent and water.

Cleaning Inside the Scanner

After using the scanner for a while, paper and room dust on the roller or the glass part inside the scanner may cause paper feed or scanned image quality problems. In such cases, clean the inside of the scanner using a dry cloth or a cloth dampened with water.

**Important:**

- Never use alcohol, thinner, or any corrosive solvent to clean the scanner. Deformation or discoloration may occur.*
- Never spray any liquid or lubricant on the scanner. Damage to equipment or circuits may cause abnormal operations.*
- Never open the scanner case.*

1. Press the  button to turn off the scanner.
2. Unplug the AC adapter from the scanner.

Maintenance

3. Pull the edge of the scanner cover firmly at the ▼ mark to open it.

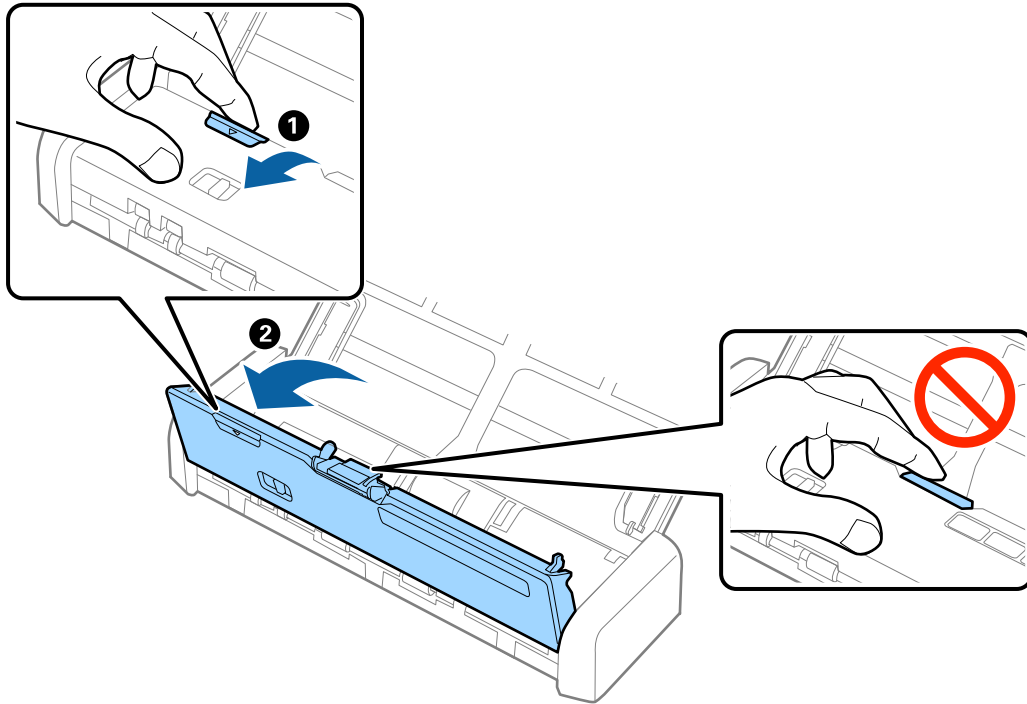

4. Wipe off any stains on the plastic roller and glass surface at the bottom inside of the scanner cover using a soft cloth.

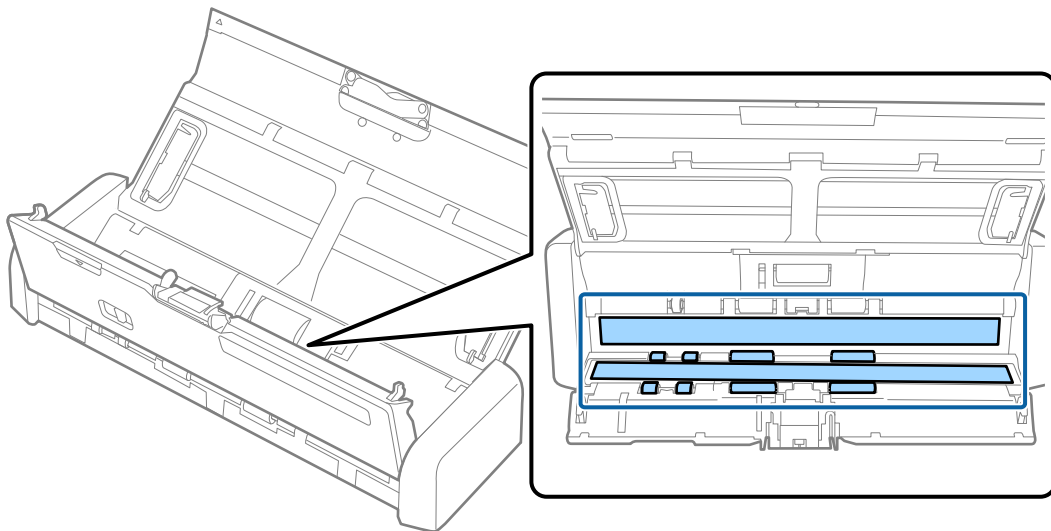

! **Important:**

- ❑ Do not place too much force on the glass surface.
- ❑ Do not use a brush or a hard tool. Any scratches on the glass may affect the scan quality.
- ❑ Do not spray cleaner directly onto the glass surface.

Maintenance

5. Hold the hooks on both sides of the separation pad, and then remove it.

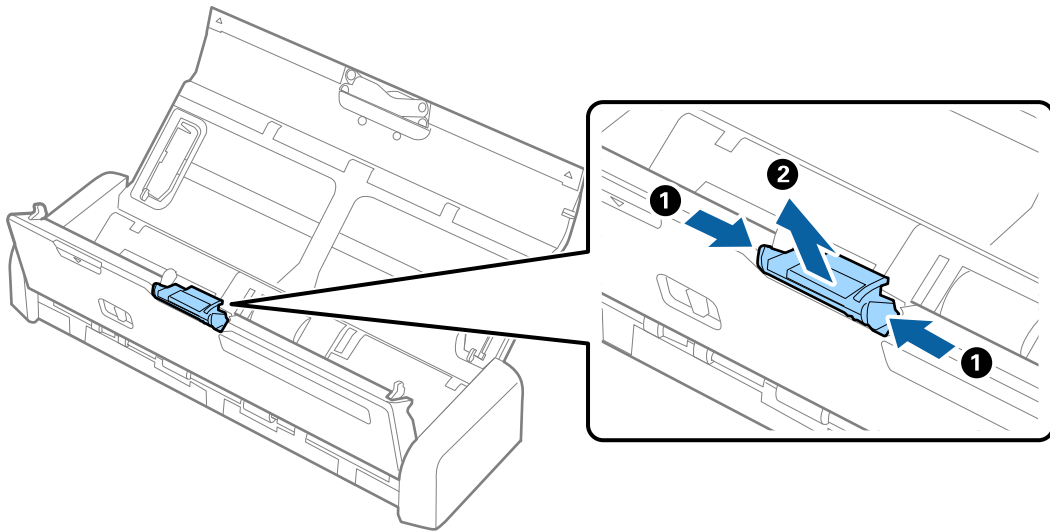

6. Wipe off any stains on the separation pad using a soft cloth.

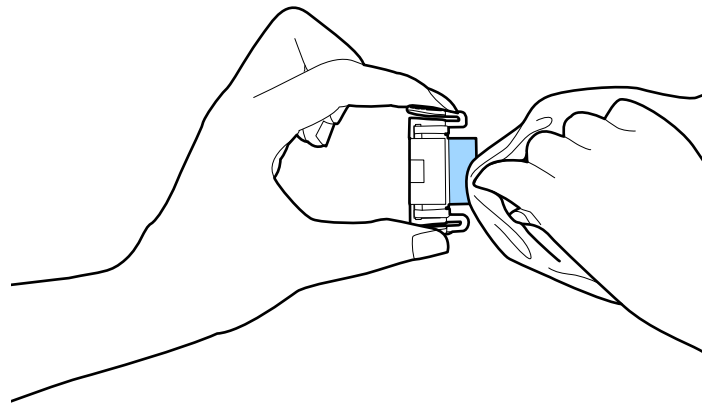

Maintenance

- Put the separation pad into the groove in the body to install it.

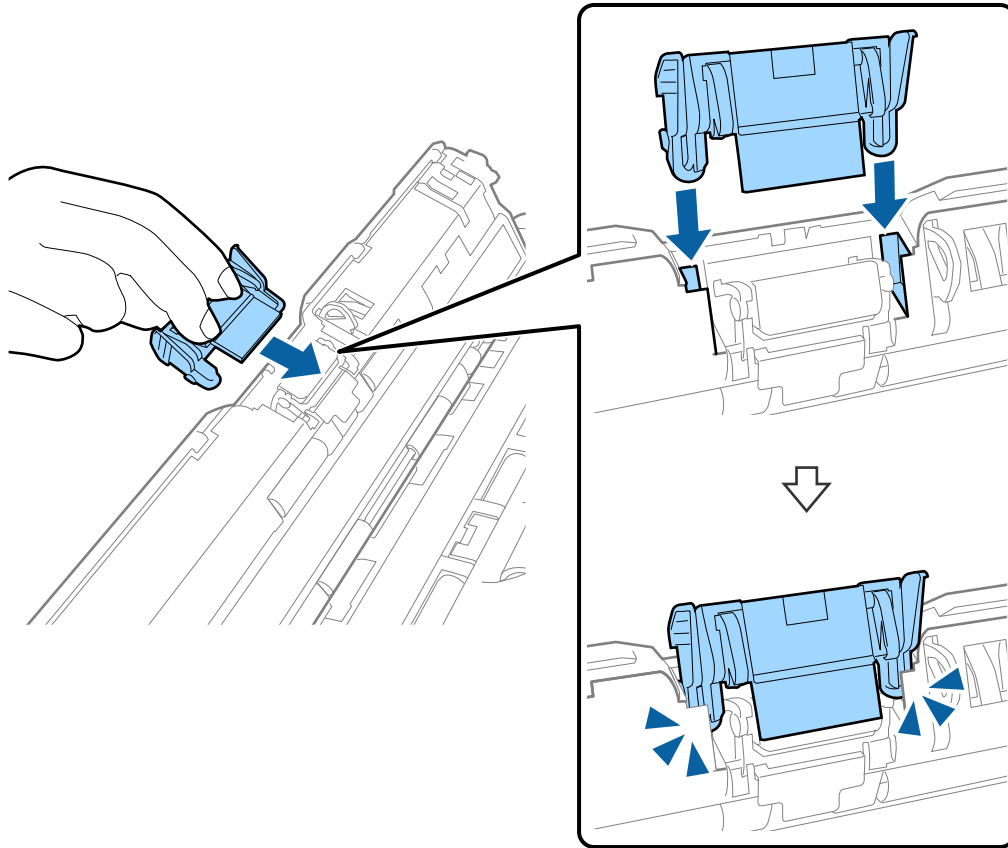

- Remove the cover of the pickup roller.

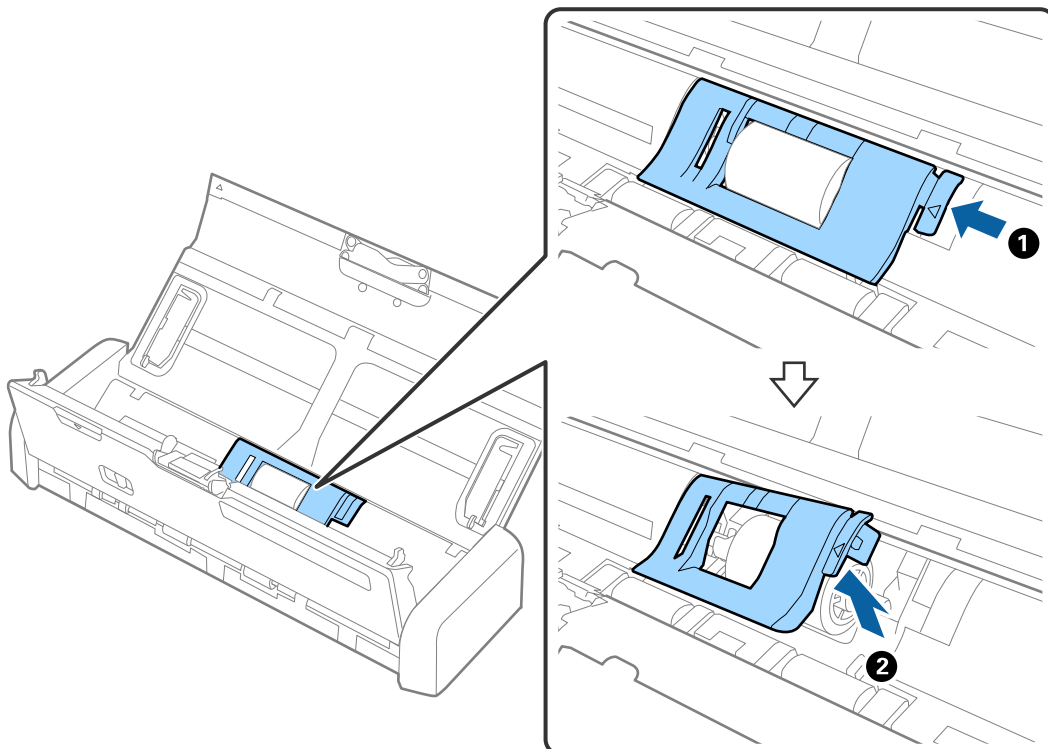

Maintenance

9. Remove the pickup roller.

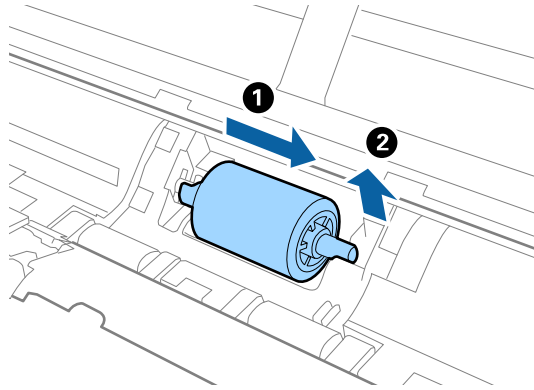

10. Wipe off any stains on the pickup roller using a soft cloth.

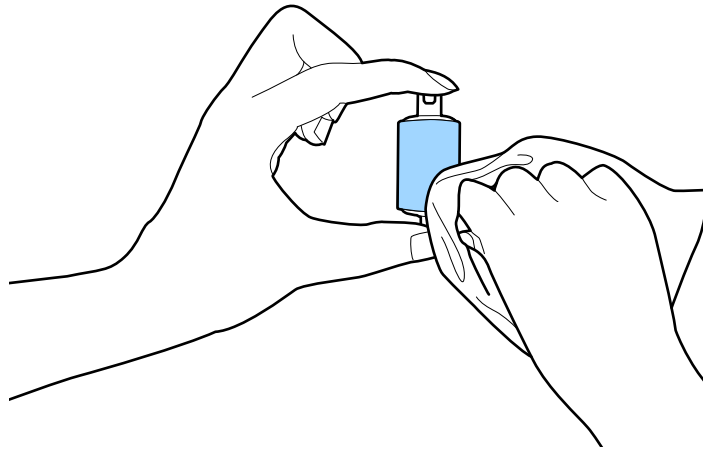

11. Slide the pickup roller to the left and insert it into the metallic axis in the body.

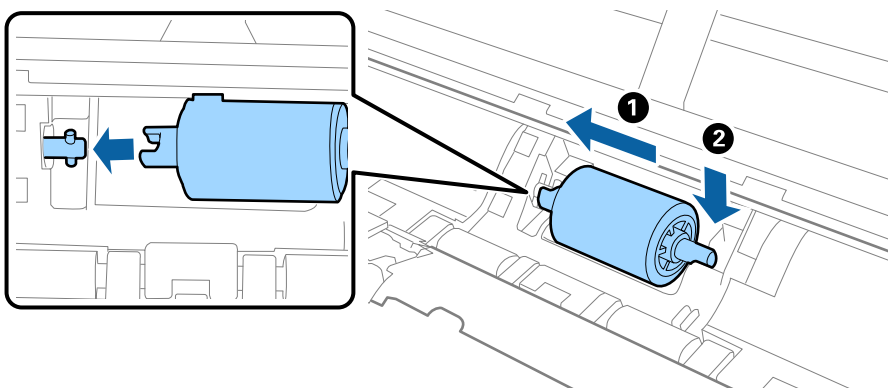

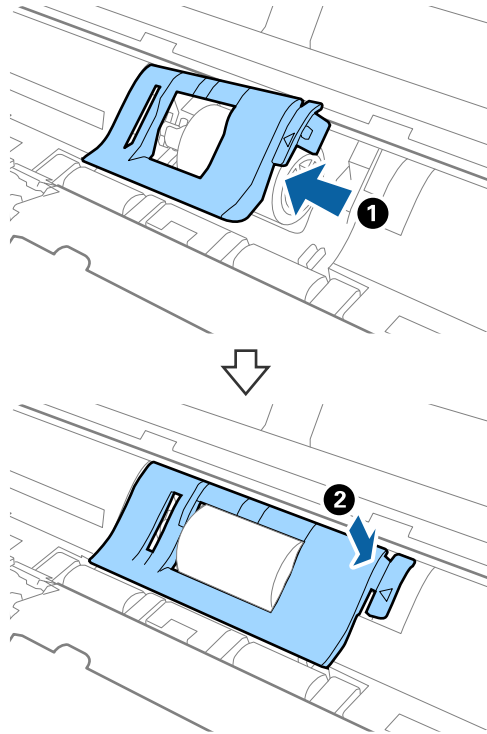

Maintenance

12. Install the cover of the pickup roller.



13. Plug in the AC adapter, and then turn on the scanner.

14. Press the  button for more than two seconds while opening the scanner cover. The rollers on the bottom and the output slot move momentarily, and then the scanner enters cleaning mode. The rollers rotate a bit each time you press the  button. Press the  button to move the rollers, and then wipe the surface of the rollers with a soft cloth. Repeat this steps several times.

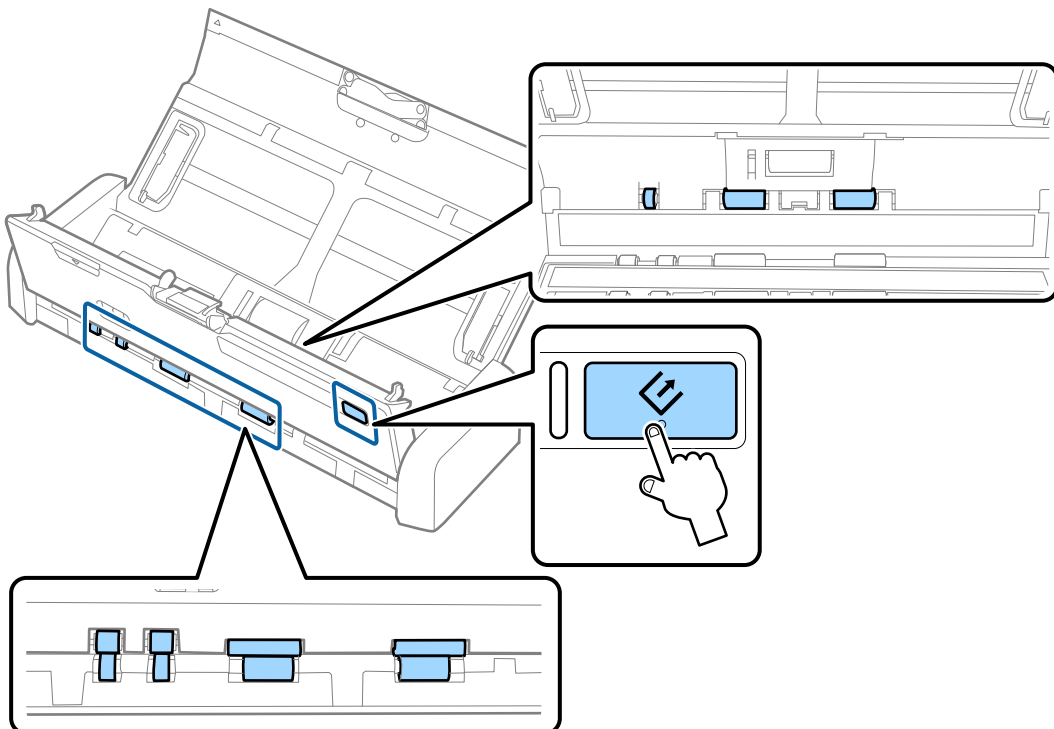

Maintenance

 **Caution:**

Be careful not to get your hands or hair caught in the mechanism when operating the roller. This could cause an injury.

15. Press the edge of the scanner cover firmly at the ▼ mark to close it.

The scanner exits cleaning mode.

Related Information

- ➔ “Pickup Roller Codes” on page 19
- ➔ “Separation Pad Codes” on page 19

Replacing Consumables

The pickup roller and the separation pad need to be replaced when the number of scans exceeds the life cycle of the roller or the pad. When a replacement message is displayed on your computer, follow the steps below to replace it and reset the scan number using Epson 2 Utility.

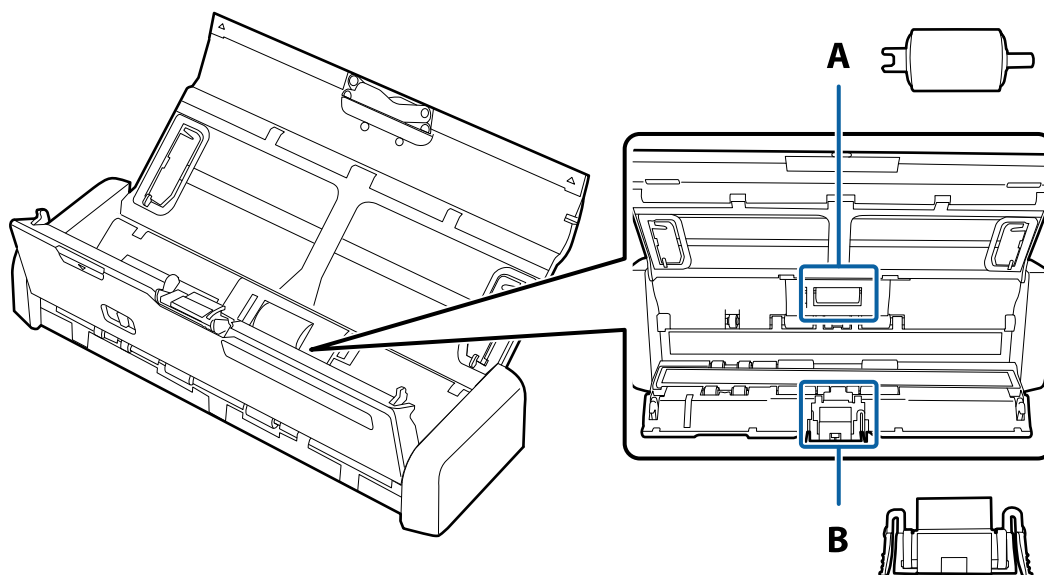

A: pickup roller, B: separation pad

Replacing the Pickup Roller

1. Press the  button to turn off the scanner.
2. Unplug the AC adapter from the scanner.

Maintenance

3. Pull the edge of the scanner cover firmly at the ▼ mark to open it.

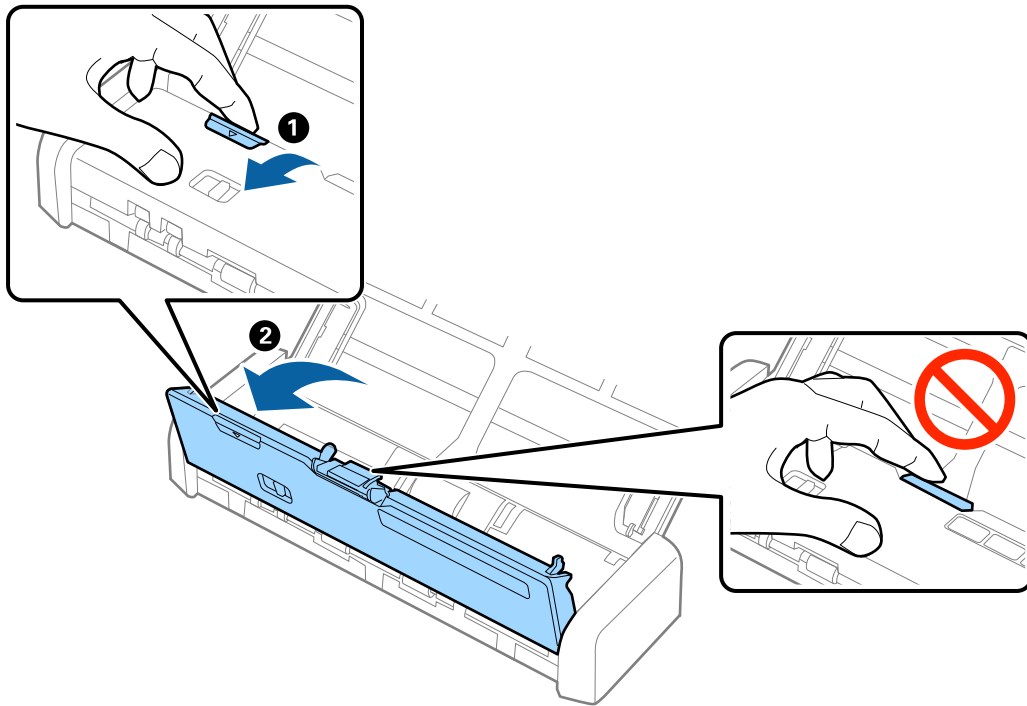

4. Remove the cover of the pickup roller.

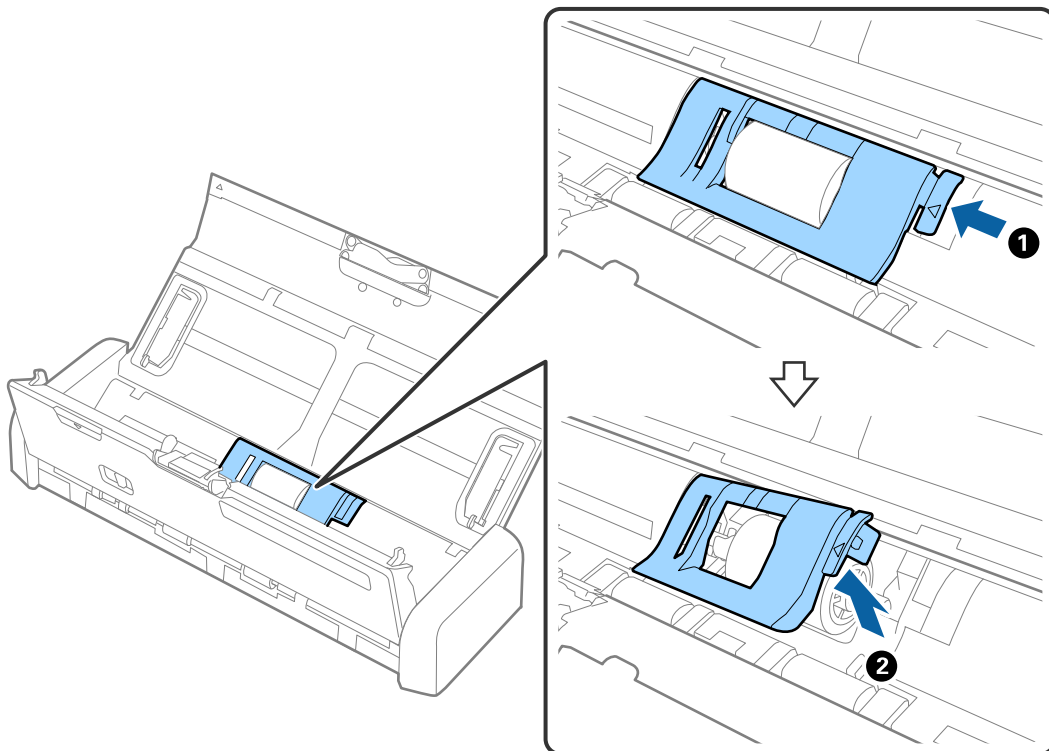

Maintenance

5. Remove the pickup roller.

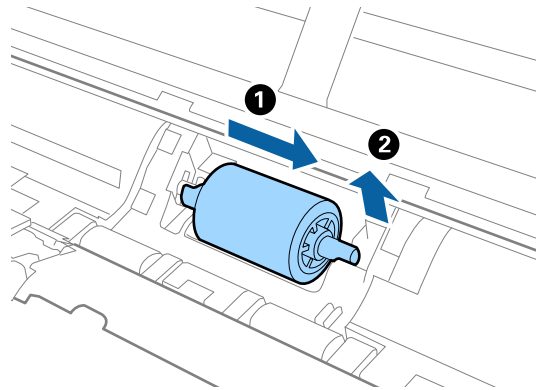

Note:

Dispose of the used pickup roller following the rules and regulations of your local authority. Do not disassemble them.

6. Slide the new pickup roller to the left and insert it into the metallic axis in the body.

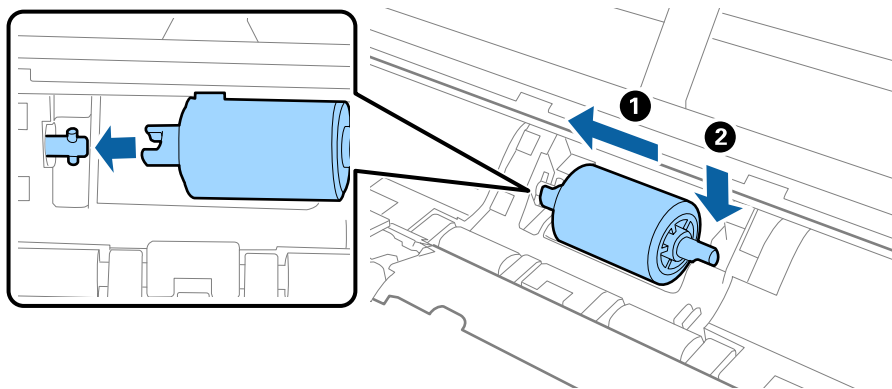

Maintenance

7. Install the cover of the pickup roller.

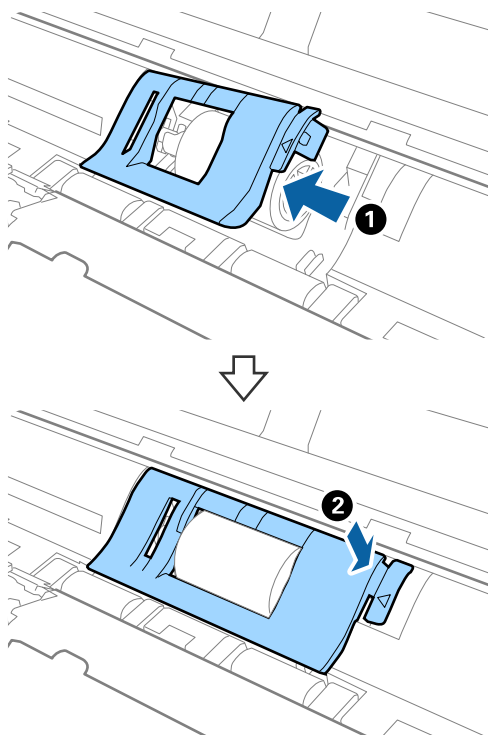

Important:

Make sure the pickup rollers are installed correctly if the cover is hard to close.

8. Press the edge of the scanner cover firmly at the ▼ mark to close it.
9. Plug in the AC adapter, and then turn on the scanner.
10. Reset the scan number using Epson Scan 2 Utility.

Replacing the Separation Pad

1. Press the  button to turn off the scanner.
2. Unplug the AC adapter from the scanner.

Maintenance

3. Pull the edge of the scanner cover firmly at the ▼ mark to open it.

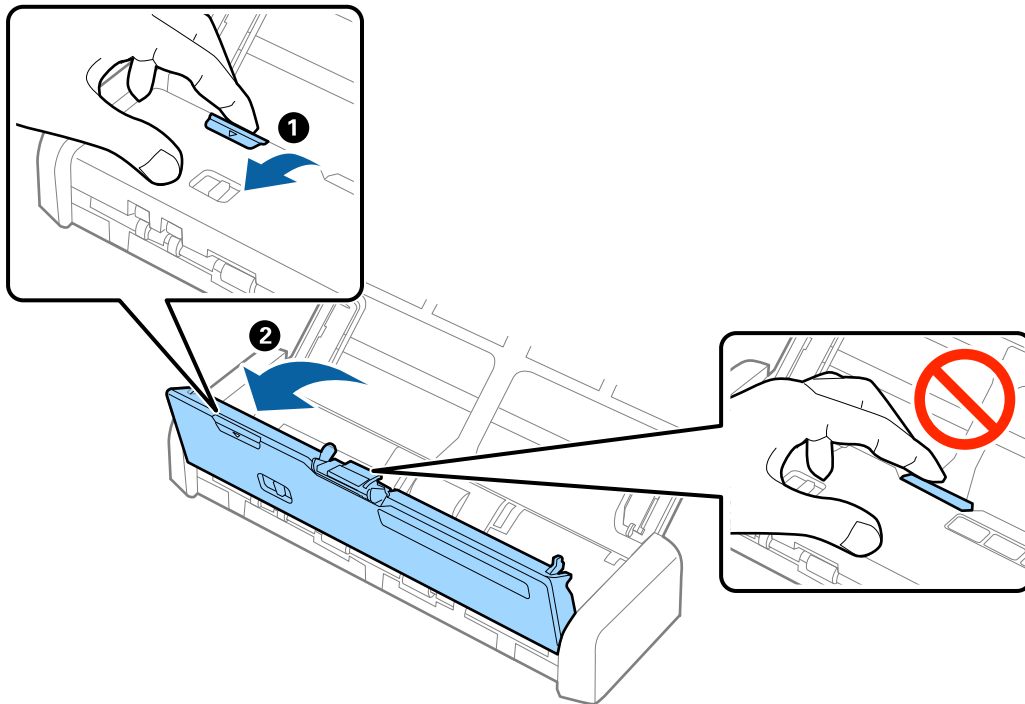

4. Hold the hooks on both sides of the separation pad, and then remove it.

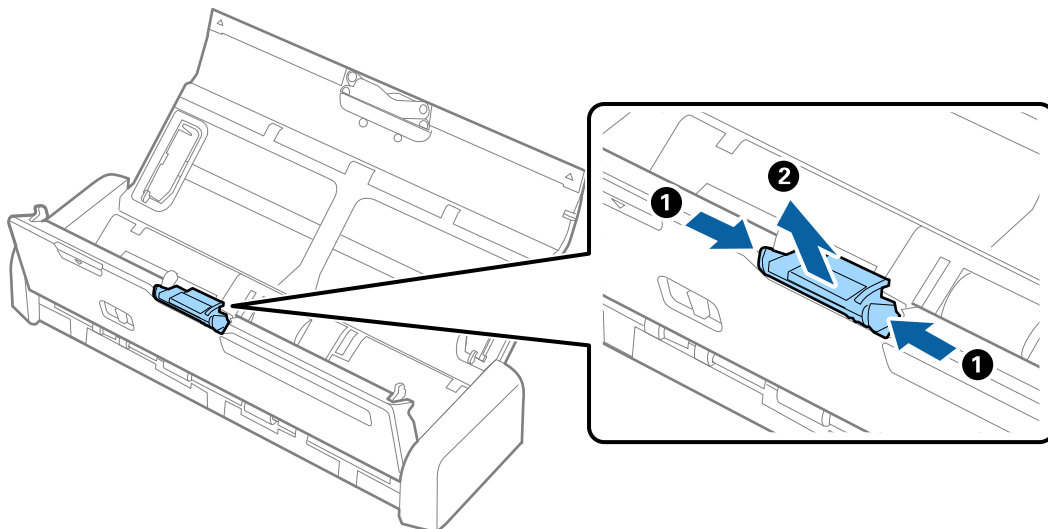

Note:

Dispose of the used separation pad following the rules and regulations of your local authority. Do not disassemble them.

Maintenance

- Put the new separation pad into the groove in the body to install it.

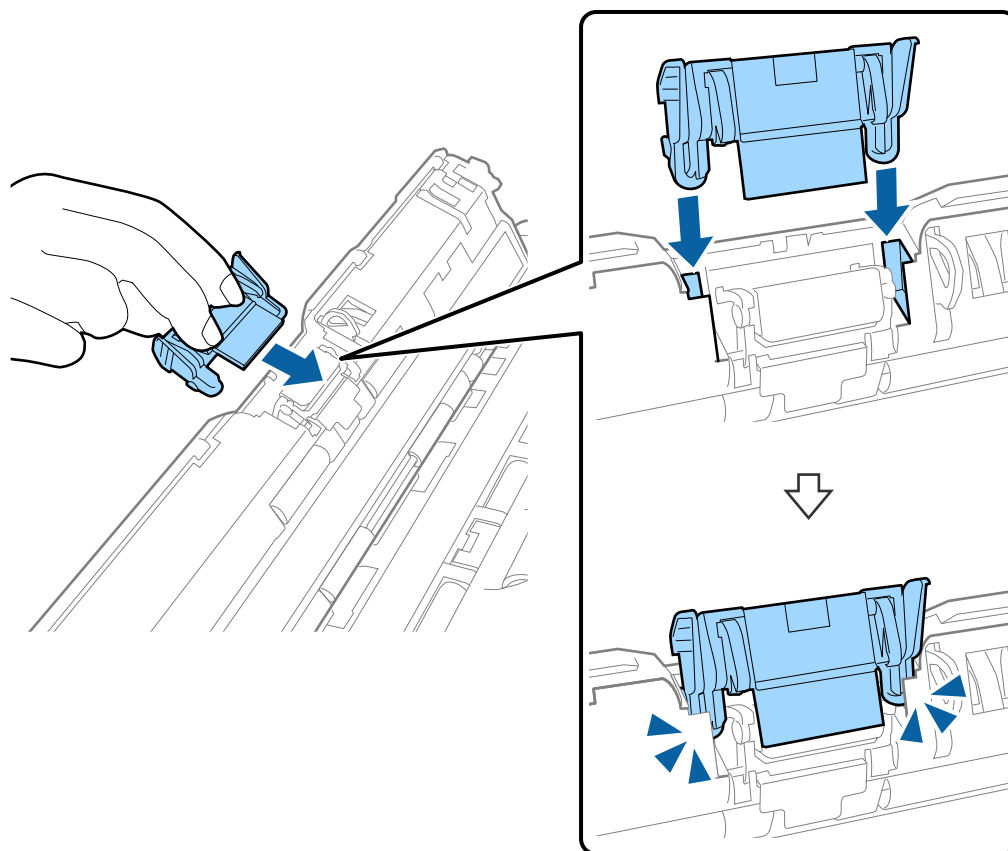

- Press the edge of the scanner cover firmly at the ▼ mark to close it.
- Plug in the AC adapter, and then turn on the scanner.
- Reset the scan number using Epson Scan 2 Utility.

Resetting the Number of Scans

Reset the number of scans using the Epson Scan 2 Utility after replacing the pickup roller or the separation pad.

- Turn on the scanner.
- Start Epson Scan 2 Utility.
 - ❑ Windows 10
Click the start button, and then select **All apps > EPSON > Epson Scan 2 > Epson Scan 2 Utility**.
 - ❑ Windows 8.1/Windows 8/Windows Server 2012 R2/Windows Server 2012
Start screen > Apps > Epson > Epson Scan 2 Utility.
 - ❑ Windows 7/Windows Vista/Windows XP/Windows Server 2008 R2/Windows Server 2008/Windows Server 2003 R2/Windows Server 2003
Click the start button, and then select **All Programs (or Programs) > EPSON > Epson Scan 2 > Epson Scan 2 Utility**.

Maintenance

❑ Mac OS X

Select **Go > Applications > EPSON Software > Epson Scan 2 Utility**.

3. Click the **Counter** tab.
4. Click **Reset** for the pickup roller or the separation pad.

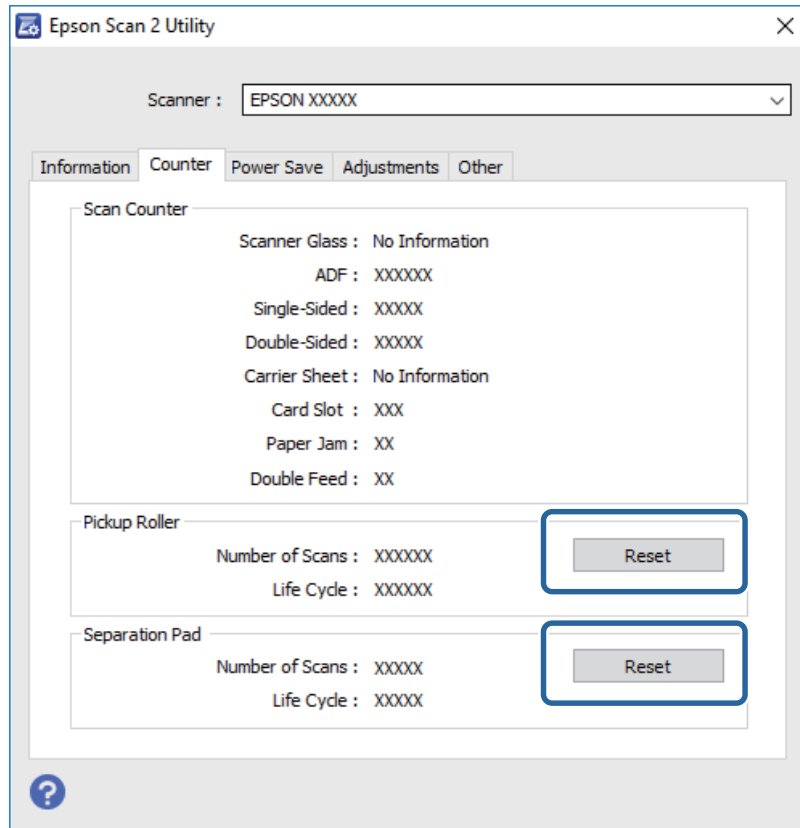

Related Information

- ➔ [“Pickup Roller Codes” on page 19](#)
- ➔ [“Separation Pad Codes” on page 19](#)

Energy Saving

You can save energy by using the sleep mode or auto power off mode when no operations are performed by the scanner. You can set the time period before the scanner enters sleep mode and turns off automatically. Any increase will affect the product's energy efficiency. Consider the environment before making any changes.

1. Start Epson Scan 2 Utility.
 - ❑ Windows 10
Click the start button, and then select **All apps > EPSON > Epson Scan 2 > Epson Scan 2 Utility**.
 - ❑ Windows 8.1/Windows 8/Windows Server 2012 R2/Windows Server 2012
Start screen > Apps > Epson > Epson Scan 2 Utility.

Maintenance

- ❑ Windows 7/Windows Vista/Windows XP/Windows Server 2008 R2/Windows Server 2008/Windows Server 2003 R2/Windows Server 2003

Click the start button, and then select **All Programs** (or **Programs**) > **EPSON** > **Epson Scan 2** > **Epson Scan 2 Utility**.

- ❑ Mac OS X

Select **Go** > **Applications** > **EPSON Software** > **Epson Scan 2 Utility**.

2. Click the **Power Save** tab.
3. Set the **Sleep Timer (minutes)** or **Power Off Timer (minutes)**, and then click **Set**.

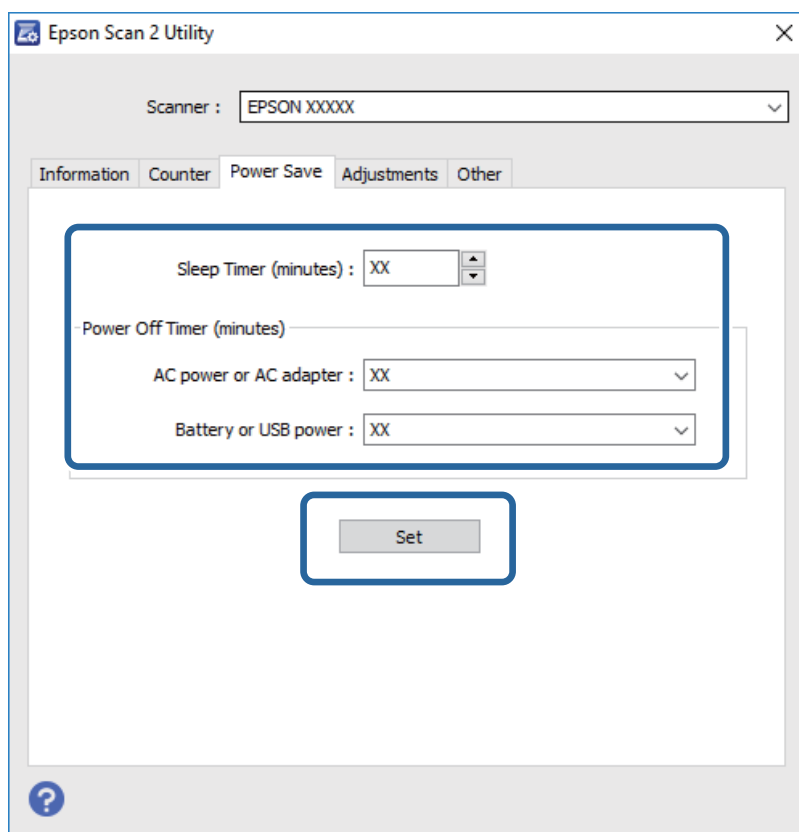

Carrying the scanner

When you need to carry or transport the scanner to move it or to make repairs, follow the steps below to pack the scanner.

Caution:

- ❑ *Strong impacts may damage the scanner.*
- ❑ *Do not expose the scanner to direct sunlight or leave it near heaters, in locations subject to high temperatures such as inside a car, and so on. The heat may cause the body to deform.*
- ❑ *We recommend taking the scanner as hand luggage on airplanes. Contact your airline to confirm if you can take the device on their airplanes. Depending on handling at the airport, the scanner could be damaged by a strong impact.*

Maintenance

1. Press the  button to turn off the scanner.
2. Unplug the AC adapter from the scanner.
3. Remove the USB cable.
4. Store the input tray extension to close the input tray.

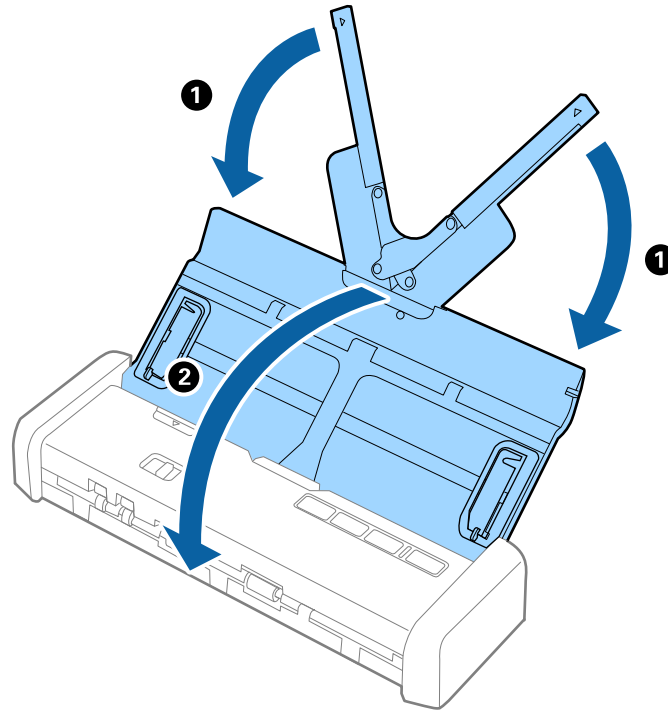

5. When transporting the scanner, attach the packing materials that came with the scanner, and then repack the scanner in its original box or a sturdy box.

Updating Applications and Firmware

You may be able to clear certain problems and improve or add functions by updating the applications and the firmware. Make sure you use the latest version of the applications and firmware.

1. Make sure that the scanner and the computer are connected, and the computer is connected to the internet.
2. Start EPSON Software Updater, and update the applications or the firmware.

Note:

Windows Server operating systems are not supported.

Windows 10

Click the start button, and select **All apps > Epson Software > EPSON Software Updater**.

Windows 8.1/Windows 8

Enter the application name in the search charm, and then select the displayed icon.

Maintenance

- Windows 7/Windows Vista/Windows XP

Click the start button, and then select **All Programs** or **Programs > Epson Software > EPSON Software Updater**.

- Mac OS X

Select **Finder > Go > Applications > Epson Software > EPSON Software Updater**.



Important:

Do not turn off the computer or the scanner while updating.

Note:

If you cannot find the application you want to update in the list, you cannot update using the EPSON Software Updater. Check for the latest versions of the applications on your local Epson website.

<http://www.epson.com>

Solving Problems

Scanner Problems

Scanner Lights Indicate an Error

Check the following if the scanner lights indicate an error.

- Make sure there are no originals jammed in the scanner.
- When feeding multiple originals, open the ADF cover and remove the originals. Next, close the ADF cover.
- Make sure the scanner cover is closed.
- Make sure the scanner is connected to your computer properly.
If a Wi-Fi connection error has occurred, check the Wi-Fi connection settings.
- Make sure Epson Scan 2 is installed correctly.
- If the firmware update fails and the scanner enters recovery mode, update the firmware again using a USB connection.
Also make sure that the AC adapter is connected to the scanner.
- Turn off the scanner and turn it on again. If this does not solve the problem, the scanner may be malfunctioning, or the light source in the scanner unit may need to be replaced. Contact your dealer.

Related Information

➔ [“Error Indicators” on page 16](#)

The Scanner Does Not Turn On

- Connect the AC adapter to the scanner.
- When using the AC adapter, make sure it is securely connected to the scanner and an electrical outlet.
Also, check that the electrical outlet is working correctly. Plug another device into the electrical outlet and check that you can turn the power on.
- To run the scanner while the battery is flat but without using the AC adapter, do the following.
 - Use USB 3.0 (SuperSpeed) port. You cannot use USB 2.0 (Hi-Speed) port or USB 1.1 port to run the scanner on a USB power supply.
 - Use the USB cable that came with the scanner.
 - Connect the scanner directly to the computer's USB port. The scanner may not work properly when connected to the computer through one or more USB hubs.
- If the scanner is running on the battery under low or high temperatures, the scanner will not turn on. Use the scanner within the operating temperature range.

The Scanner Turns Off when Running on the Battery

- ❑ Connect the AC adapter to the scanner.
- ❑ Use the scanner within the operating temperature range. The scanner may turn off suddenly under low or high temperatures.

- ❑ **Power Save** settings might be set in **Epson Scan 2 Utility**.

Start **Epson Scan 2 Utility**, select the **Power Save** tab, and then check the settings. To start **Epson Scan 2 Utility**, see following for details.

- ❑ Windows 10

Click the start button, and then select **All apps > EPSON > Epson Scan 2 Utility**.

- ❑ Windows 8.1/Windows 8/Windows Server 2012 R2/Windows Server 2012

Enter the application name in the search charm, and then select the displayed icon.

- ❑ Windows 7/Windows Vista/Windows XP/Windows Server 2008 R2/Windows Server 2008/Windows Server 2003 R2/Windows Server 2003

Click the start button, and then select **All Programs** or **Programs > EPSON > Epson Scan 2 > Epson Scan 2 Utility**.

- ❑ Mac OS X

Select **Go > Applications > Epson Software > Epson Scan 2 Utility**.

The Scanner Does not Turn Off when Running on the Battery

Make sure the AC adapter and the USB cable are disconnected. Then press the reset button on the bottom of the scanner.

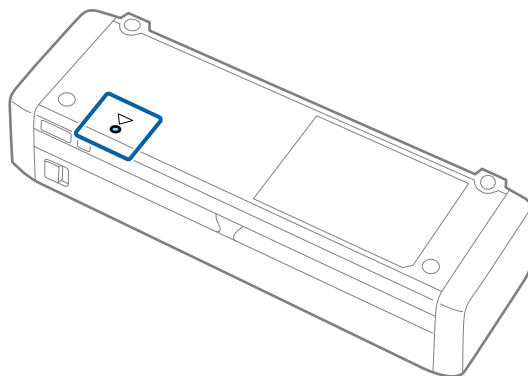

Problems Starting Scanning

Cannot Start Epson Scan 2

- ❑ Make sure the scanner is connected to your computer properly.
If a Wi-Fi connection error has occurred, check the Wi-Fi connection settings.
- ❑ Make sure the USB cable is securely connected to the scanner and the computer.
- ❑ Use the USB cable that came with the scanner.

Solving Problems

- Make sure the scanner is turned on.
- Wait until the status light stops flashing indicating that the scanner is ready to scan.
- Connect the scanner directly to the computer's USB port. The scanner may not work properly when connected to the computer through one or more USB hubs.
- If you are using any TWAIN-compliant applications, make sure that the correct scanner is selected as the scanner or source setting.

Pressing a Scanner Button Does Not Start the Correct Application

- Make sure the scanner is connected to your computer properly.
- Make sure Epson Scan 2 and other applications are installed correctly.
- Make sure Document Capture Pro (Windows) or Document Capture (Mac OS X) is installed correctly.
- Check the correct setting is assigned to the scanner button in Document Capture Pro (Windows) or Document Capture (Mac OS X).
- When using a wireless connection, you cannot run the job assigned to a scanner button by pressing it because Document Capture Pro and Document Capture do not support scanning from the button over a wireless connection.

To start scanning by pressing the button, launch Epson Scan 2 on your computer before scanning.

Related Information

➔ [“Scanning Using a Scanner Button” on page 61](#)

Paper Feeding Problems

Multiple Originals Are Fed

If multiple originals are fed, open the scanner cover and remove the originals. Next, close the scanner cover.

If multiple originals are fed frequently, try the following.

- Make sure the number of sheets you loaded into the ADF does not exceed the loading capacity.
The following information provides the standard loading capacities.
 - Plain Paper: 20
 - Business Cards: 6
 - Receipts: 1

Solving Problems

- ❑ To feed stacks of originals correctly, slide the leading edge so that it is at an angle before loading them into the scanner.

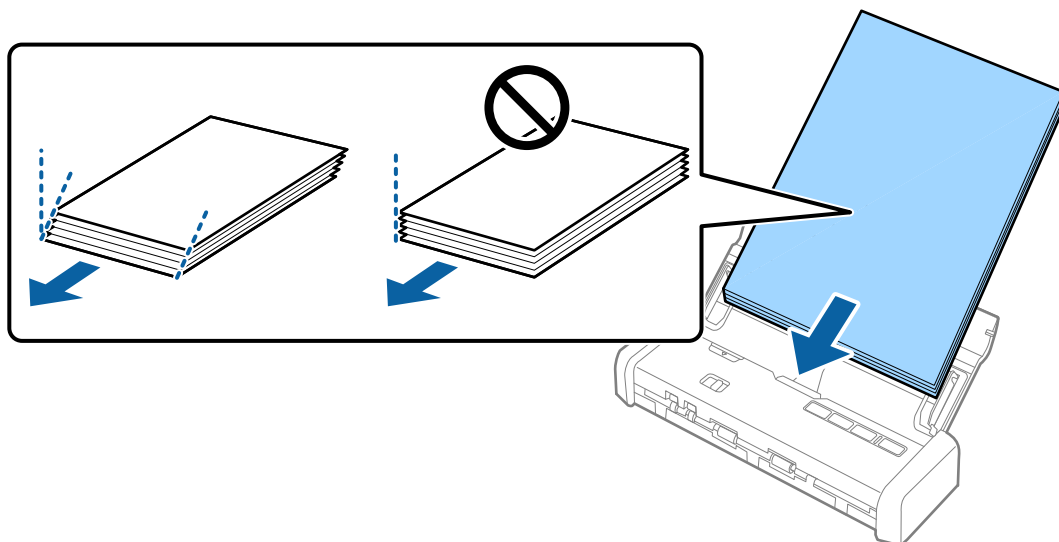

- ❑ If you load unsupported originals, the scanner may feed multiple originals at a time.
- ❑ Clean the rollers inside the scanner.
- ❑ Reduce the number of originals being placed at a time.
- ❑ Use **Automatic Feeding Mode** in Epson Scan 2, and scan originals one by one.

Related Information

- ➔ [“Specifications of Originals for Scanning from the ADF” on page 24](#)
- ➔ [“Cleaning Inside the Scanner” on page 100](#)
- ➔ [“Scanning Different Sizes or Types of Originals One by One \(Automatic Feeding Mode\)” on page 63](#)
- ➔ [“Placing Standard Size Originals” on page 30](#)

Removing Jammed Originals from the Scanner

If an original has jammed inside the scanner, follow these steps to remove it.

Note:

If the AC adapter is disconnected while scanning, the scanner stops and an error is displayed. Do not disconnect the AC adapter when scanning.

1. Remove all originals remaining in the input tray.

Solving Problems

2. Pull the edge of the scanner cover firmly at the ▼ mark to open it.

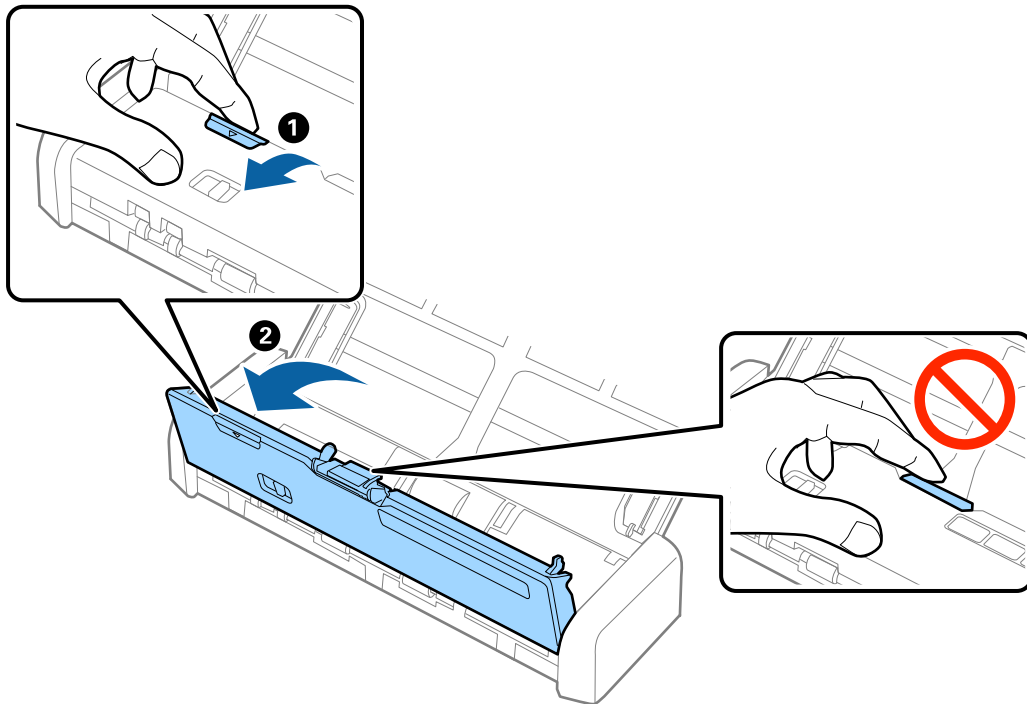

3. Carefully remove any originals remaining inside the scanner.

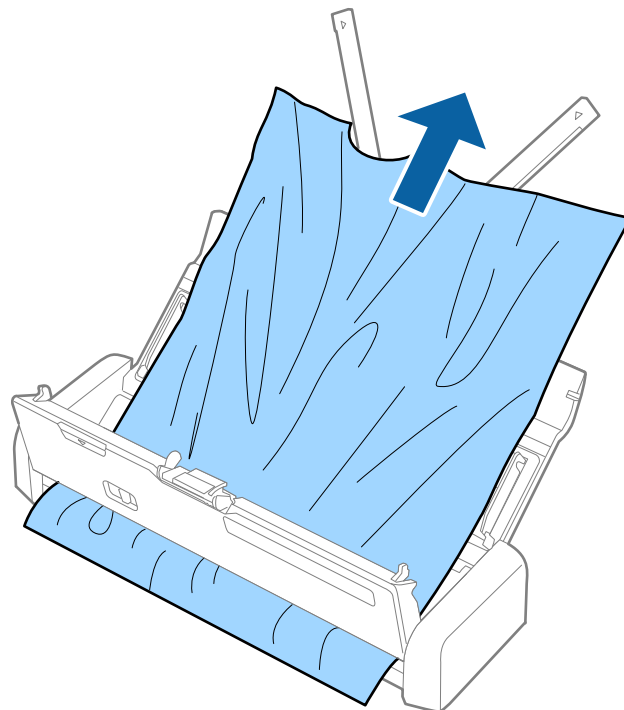

4. Press the edge of the scanner cover firmly at the ▼ mark to close it.

The Originals Get Dirty

Clean the inside of the scanner.

Related Information



➔ [“Cleaning Inside the Scanner” on page 100](#)

Scanning Takes a Long Time

- If the scanner is running on a USB power supply, scanning speed is reduced. If you want to increase the scanning speed, connect the AC adapter to the scanner.
- If the scanner is running on the battery and the battery level is low, scanning speed is reduced. Connect the AC adapter to the scanner.
- When the resolution is high, scanning may take some time.
- Computers with USB 3.0 (SuperSpeed) or USB 2.0 (Hi-Speed) ports can scan faster than those with USB 1.1 ports. If you are using a USB 3.0 or USB 2.0 port with the scanner, make sure the computer meets the system requirements for the operating system.
- When using security software, exclude the TWAIN.log file from monitoring, or set the TWAIN.log as a read-only file. For more information on your security software's functions, see the help and so on supplied with the software. The TWAIN.log file is saved in the following locations.
 - Windows 10/Windows 8.1/ Windows 8/ Windows 7/ Windows Vista:
C:\Users\(\user name)\AppData\Local\Temp
 - Windows XP:
C:\Documents and Settings\(\user name)\Local Settings\Temp

Scanned Image Problems

Scanned Text or Images are Blurred

- Make sure the feed selector on the scanner is set correctly. To scan originals using ADF, set the feed selector to  (ADF). To scan a plastic card using the card slot, set the feed selector to  (card).
- In Epson Scan 2, select the **Advanced Settings** tab, and then **Image Option > Text Enhancement**.
- In Epson Scan 2, when **Image Type** on the **Main Settings** tab is set to **Black & White**, adjust the **Threshold** on the **Advanced Settings** tab. When you increase the **Threshold**, black becomes stronger.
- If the resolution is low, try increasing the resolution and then scanning.

Straight Lines Appear when Scanning from ADF

- Clean the ADF.
Straight lines may appear in the image when trash or dirt gets into the ADF.
- Remove any trash or dirt that adheres to the original.

Solving Problems

Related Information

- ➔ [“Cleaning Inside the Scanner” on page 100](#)

The Image Quality is Rough

- ❑ If the resolution is low, try increasing the resolution and then scanning.
- ❑ In Epson Scan 2, adjust the image using items on the **Advanced Settings** tab, and then scan.

Related Information

- ➔ [“Setting a Resolution That Suits the Scanning Purpose” on page 55](#)
- ➔ [“Image Adjustment Features” on page 64](#)

Expanding or Contracting the Scanned Image

When expanding or contracting the scanned image, you can adjust the expansion ratio by using the **Adjustments** feature in Epson Scan 2 Utility. This feature is only available for Windows.

Note:

Epson Scan 2 Utility is an application that comes with Epson Scan 2.

1. Start Epson Scan 2 Utility.
 - ❑ Windows 10
Click the start button, and then select **All apps > EPSON > Epson Scan 2 > Epson Scan 2 Utility**.
 - ❑ Windows 8.1/Windows 8/Windows Server 2012 R2/Windows Server 2012
Enter the application name in the search charm, and then select the displayed icon.
 - ❑ Windows 7/Windows Vista/Windows XP/Windows Server 2008 R2/Windows Server 2008/Windows Server 2003 R2/Windows Server 2003
Click the start button, and then select **All Programs or Programs > EPSON > Epson Scan 2 > Epson Scan 2 Utility**.
2. Select the **Adjustments** tab.
3. Use **Expansion/Contraction** to adjust the expansion ratio for scanned images.
4. Click **Set** to apply the settings to the scanner.

Offset Appears in the Background of Images

Images on the back of the original may appear in the scanned image.

- ❑ In Epson Scan 2, select the **Advanced Settings** tab, and then adjust the **Brightness**.
This feature may not be available depending on the settings on the **Main Settings** tab > **Image Type** or other settings on the **Advanced Settings** tab.
- ❑ In Epson Scan 2, select the **Advanced Settings** tab, and then **Image Option > Text Enhancement**.

Solving Problems

Related Information

➔ [“Brightness” on page 68](#)

You can adjust the brightness for the whole image.

➔ [“Text Enhancement” on page 67](#)

You can make blurred letters in the original clear and sharp. You can also reduce the offset or unevenness of the background.

Moiré Patterns (Web-Like Shadows) Appear

If the original is a printed document, moiré patterns (web-like shadows) may appear in the scanned image.

- ❑ On the **Advanced Settings** tab in Epson Scan 2, set **Descreening**.



- ❑ Change the resolution, and then scan again.

Related Information

➔ [“Descreening” on page 66](#)

You can remove moiré patterns (web-like shadows) that appear when scanning printed paper such as a magazine.

➔ [“Setting a Resolution That Suits the Scanning Purpose” on page 55](#)

The Edge of the Original is Not Scanned when Automatically Detecting the Size of the Original

- ❑ In Epson Scan 2, select the **Main Settings** tab, and then select **Document Size > Settings**. On the **Document Size Settings** window, adjust **Crop Margins for Size "Auto"**.
- ❑ Depending on the original, the area of the original may not be detected correctly when using the **Auto Detect** feature. Select the appropriate size of the original from the **Document Size** list.

Note:

*If the size of the original you want to scan is not on the list, select **Customize**, and then create the size manually.*

When Scanning a Plastic Card, the Image is Curved, Tilted, Incomplete, or Contains Lines

The card may not be scanned correctly if you load it at an angle, or to the left or right of the card slot. Load the plastic card straight, within the white border lines of the card slot.

Solving Problems

Text is Not Recognized Correctly when Saving as a Searchable PDF

- ❑ On the **Image Format Options** window in Epson Scan 2, check that **Text Language** is set correctly on the **Text** tab.
- ❑ Check that the original is placed straight.
- ❑ Use an original with clear text. Text recognition may decline for the following types of originals.
 - ❑ Originals that have been copied a number of times
 - ❑ Originals received by fax (at low resolutions)
 - ❑ Originals on which the letter spacing or line spacing is too small
 - ❑ Originals with ruled lines or underlining over the text
 - ❑ Originals with hand-written text
 - ❑ Originals with creases or wrinkles
- ❑ In Epson Scan 2, when **Image Type** on the **Main Settings** tab is set to **Black & White**, adjust the **Threshold** on the **Advanced Settings** tab. When you increase the **Threshold**, the black color area becomes larger.
- ❑ In Epson Scan 2, select the **Advanced Settings** tab, and then **Image Option > Text Enhancement**.

Related Information

➔ [“Saving as a Searchable PDF” on page 71](#)

➔ [“Text Enhancement” on page 67](#)

You can make blurred letters in the original clear and sharp. You can also reduce the offset or unevenness of the background.

➔ [“Threshold” on page 69](#)

You can adjust the border for monochrome binary (black and white). Increase the threshold, the black color area becomes larger. Decrease the threshold, the white color area becomes larger.

Cannot Solve Problems in the Scanned Image

If you have tried all of the solutions and have not solved the problem, initialize the Epson Scan 2 settings using Epson Scan 2 Utility.

Note:

Epson Scan 2 Utility is an application that comes with Epson Scan 2.

1. Start Epson Scan 2 Utility.

❑ Windows 10

Click the start button, and then select **All apps > EPSON > Epson Scan 2 Utility**.

❑ Windows 8.1/Windows 8/Windows Server 2012 R2/Windows Server 2012

Enter the application name in the search charm, and then select the displayed icon.

❑ Windows 7/Windows Vista/Windows XP/Windows Server 2008 R2/Windows Server 2008/Windows Server 2003 R2/Windows Server 2003

Click the start button, and then select **All Programs** or **Programs > EPSON > Epson Scan 2 > Epson Scan 2 Utility**.

❑ Mac OS X

Select **Go > Applications > Epson Software > Epson Scan 2 Utility**.

Solving Problems

2. Select the **Other** tab.
3. Click **Reset**.

Note:

If initialization does not solve the problem, uninstall and re-install Epson Scan 2.

Network Problems

When You Cannot Make Network Settings

Turn off the devices you want to connect to the network. Wait for about 10 seconds, and then turn on the devices in the following order; access point, computer or smart device, and then scanner. Move the scanner and computer or smart device closer to the access point to help with radio wave communication, and then try to make network settings again.

Cannot Connect from Devices Even Though Network Settings are No Problems

If you cannot connect from the computer or smart device to the scanner even though network settings of the scanner are no problem, see the following.

- When you are using multiple access points at the same time, you may not be able to use the scanner from the computer or smart device depending on the settings of the access points. Connect the computer or smart device to the same access point as the scanner.

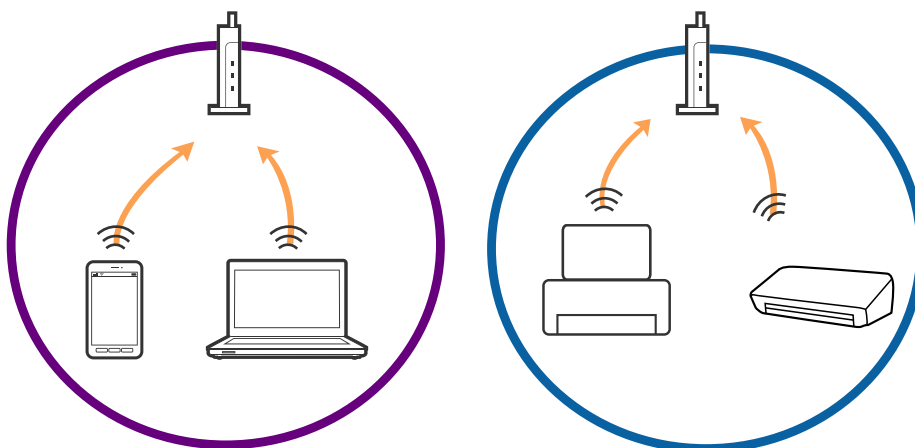

Solving Problems

- ❑ You may not be able to connect to the access point when the access point has multiple SSIDs and devices are connected to different SSIDs on the same access point. Connect the computer or smart device to the same SSID as the scanner.

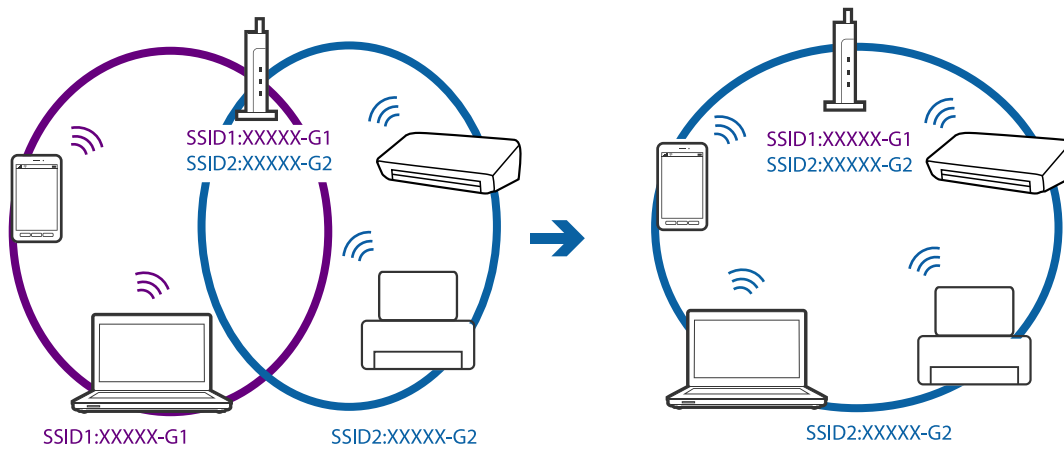

- ❑ An access point that is compliant with both IEEE802.11a and IEEE802.11g has SSIDs of 2.4 GHz and 5 GHz. If you connect the computer or smart device to a 5 GHz SSID, you cannot connect to the scanner because the scanner only supports communication over 2.4 GHz. Connect the computer or smart device to the same SSID as the scanner.

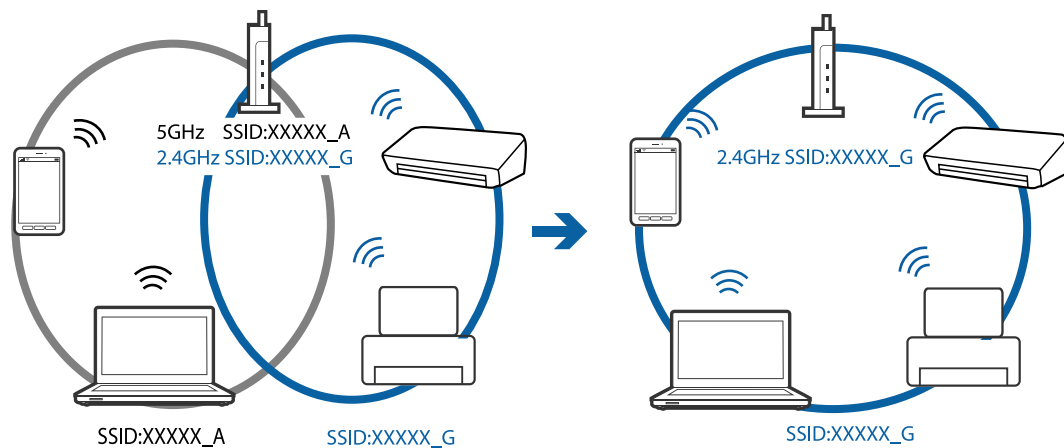

- ❑ Most access points have a privacy separator feature that blocks communication between connected devices. If you cannot communicate between the scanner and the computer or smart device even if they are connected to the same network, disable the privacy separator on the access point. See the manual provided with the access point for details.

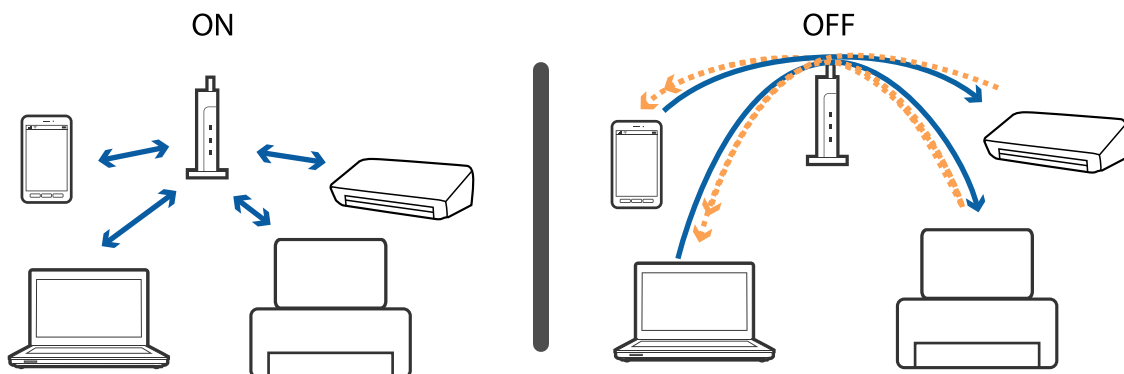

Solving Problems

Related Information

- ➔ [“Checking the SSID Connected to the Scanner” on page 127](#)
- ➔ [“Checking the SSID for the Computer” on page 127](#)

Checking the SSID Connected to the Scanner

You can check the connected SSID on EpsonNet Config.

And you can check the SSID and password of scanner itself on the label stuck to the bottom face of the scanner. These are used when you connect the scanner in AP mode connection.

Related Information

- ➔ [“EpsonNet Config” on page 18](#)

Checking the SSID for the Computer

Windows

Select **Control Panel > Network and Internet > Network and Sharing Center**.

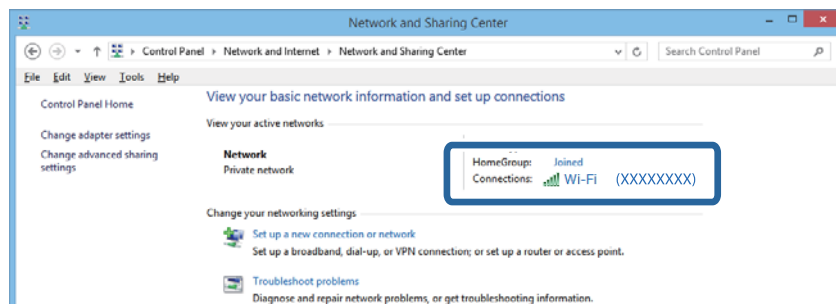

Mac OS X

Click the Wi-Fi icon at the top of the computer screen. A list of SSIDs is displayed and the connected SSID is indicated with a check mark.



The Scanner Suddenly Cannot Scan over a Network Connection

- ❑ When you have changed your access point or provider, try making network settings for the scanner again. Connect the computer or smart device to the same SSID as the scanner.
- ❑ Turn off the devices you want to connect to the network. Wait for about 10 seconds, and then turn on the devices in the following order; access point, computer or smart device, and then scanner. Move the scanner and computer or smart device closer to the access point to help with radio wave communication, and then try to make network settings again.
- ❑ Try accessing any website from your computer to make sure that your computer's network settings are correct. If you cannot access any websites, there is a problem on the computer. See the manual provided with your computer for more details.
- ❑ Check if the network setting is correct on Epson Scan 2 Utility.
- ❑ When scanning from the scanner button, make sure you start Epson Scan 2 on your computer before pressing the scanner button.

Related Information

- ➔ [“Checking the SSID Connected to the Scanner” on page 127](#)
- ➔ [“Checking the SSID for the Computer” on page 127](#)
- ➔ [“Cannot Connect from Devices Even Though Network Settings are No Problems” on page 125](#)
- ➔ [“Scanning Using Epson Scan 2” on page 52](#)

Suddenly the Scanner became Unable to Scan - USB

- ❑ Make sure the connection mode switch is set to .
- ❑ Disconnect the USB cable from the computer. Right-click on the scanner icon displayed on the computer, and then select **Remove Device**. Connect the USB cable to the computer and try a test scan. If scanning is possible, the setup is complete.
- ❑ Re-set the USB connection following the steps in [Changing the Connection Method to a Computer] in this manual.

Related Information

- ➔ [“Changing the Connection Method to a Computer” on page 97](#)

Uninstalling and Installing Applications

Uninstalling Your Applications

You may need to uninstall and then reinstall your applications to solve certain problems or if you upgrade your operating system. Log on to your computer as an administrator. Enter the administrator password if the computer prompts you.

Uninstalling Your Applications for Windows

1. Quit all running applications.
2. Disconnect the scanner from your computer.
3. Open the Control Panel:
 - Windows 10
Right-click the start button or press and hold it, and then select **Control Panel**.
 - Windows 8.1/Windows 8/Windows Server 2012 R2/Windows Server 2012
Select **Desktop > Settings > Control Panel**.
 - Windows 7/Windows Vista/Windows XP/Windows Server 2008 R2/Windows Server 2008/Windows Server 2003 R2/Windows Server 2003
Click the start button and select **Control Panel**.
4. Open **Uninstall a program** (or **Add or Remove Programs**):
 - Windows 10/Windows 8.1/Windows 8/Windows 7/Windows Vista/Windows Server 2012 R2/Windows Server 2012/Windows Server 2008 R2/Windows Server 2008
Select **Uninstall a program** in **Programs**.
 - Windows XP/Windows Server 2003 R2/Windows Server 2003
Click **Add or Remove Programs**.
5. Select the application you want to uninstall.
6. Uninstall the applications:
 - Windows 10/Windows 8.1/Windows 8/Windows 7/Windows Vista/Windows Server 2012 R2/Windows Server 2012/Windows Server 2008 R2/Windows Server 2008
Click **Uninstall/Change** or **Uninstall**.
 - Windows XP/Windows Server 2003 R2/Windows Server 2003
Click **Change/Remove** or **Remove**.

Note:

If the User Account Control window is displayed, click Continue.

7. Follow the on-screen instructions.

Note:

*A message may be displayed prompting you to restart your computer. If it is displayed, make sure **I want to restart my computer now** is selected, and then click **Finish**.*

Uninstalling Your Applications for Mac OS X

Note:

Make sure you installed EPSON Software Updater.

1. Download the Uninstaller using EPSON Software Updater.
Once you have downloaded the Uninstaller, you do not need to download it again each time you uninstall the application.

Solving Problems

2. Disconnect the scanner from your computer.
3. To uninstall the scanner driver, select **System Preferences** from the  menu > **Printers & Scanners** (or **Print & Scan, Print & Fax**), and then remove the scanner from the enabled scanner list.
4. Quit all running applications.
5. Select **Finder > Go > Applications > Epson Software > Uninstaller**.
6. Select the application you want to uninstall, and then click Uninstall.

**Important:**

The Uninstaller removes all drivers for Epson scanners on the computer. If you use multiple Epson scanners and you only want to delete some of the drivers, delete all of them first, and then install the necessary scanner drivers again.

Note:

*If you cannot find the application you want to uninstall in the application list, you cannot uninstall using the Uninstaller. In this situation, select **Finder > Go > Applications > Epson Software**, select the application you want to uninstall, and then drag it to the trash icon.*

Installing Your Applications

Follow the steps below to install the necessary applications.

Note:

- Log on to your computer as an administrator. Enter the administrator password if the computer prompts you.
- When reinstalling applications, you need to uninstall them first.

1. Quit all running applications.
2. When installing Epson Scan 2, disconnect the scanner and the computer temporarily.

Note:

Do not connect the scanner and the computer until you are instructed to do so.

3. Install the application by following the instructions on the Website below.

<http://epson.sn>

Note:

For Windows, you can also use the software disc that came with the scanner.

Technical Specifications

General Scanner Specifications

Note:

Specifications are subject to change without notice.

Scanner type	Portable sheet-feed, one pass duplex color scanner
Photoelectric device	CIS
Effective pixels	5,100×8,700 at 600 dpi 5,100×13,200 at 300 dpi
Light source	RGB LED
Scanning resolution	600 dpi (main scan) 600 dpi (sub scan)
Output resolution	50 to 1,200 dpi (in 1 dpi increments)* ¹
Document Size	Max: 215.9×1,117.6 mm (8.5×44 inches) Min: 89×70 mm (3.5×2.75 inches)
Paper input	Face-down loading (ADF) Face-up loading (Card Slot)
Paper output	Face-down ejection (ADF) Face-up ejection (Card Slot)
Paper capacity	Thickness of the originals stack: under 2 mm (0.07 in.) 64 g/m ² : 25 sheets 80 g/m ² : 20 sheets 128 g/m ² : 12 sheets The loading capacity varies depending on the paper type.
Color Depth	Color <input type="checkbox"/> 48 bits per pixel internal (16 bits per pixel per color internal) <input type="checkbox"/> 24 bits per pixel external (8 bits per pixel per color external) Grayscale <input type="checkbox"/> 16 bits per pixel internal <input type="checkbox"/> 8 bits per pixel external Black and white <input type="checkbox"/> 16 bits per pixel internal <input type="checkbox"/> 1 bit per pixel external

Technical Specifications

Interface ^{*2}	Super-Speed USB IEEE802.11b/g/n
-------------------------	------------------------------------

*1 50 to 300 dpi (368.3 to 1,117.6 mm (14.5 to 44 in.) in length)

*2 You cannot use a USB and network connection at the same time.

Wi-Fi Specifications

Standards	IEEE802.11b/g/n
Frequency Range	2.4 GHz
Maximum radio-frequency power transmitted	18.2 dBm (EIRP)
Coordination Modes	Infrastructure mode, AP mode ^{*1 *2}
Wireless Security	WEP (64/128bit), WPA2-PSK (AES) ^{*1 *3}

*1 Not supported for IEEE 802.11b.

*2 AP mode connection and Wi-Fi connection can be used at the same time.

*3 Complies with WPA2 standards with support for WPA/WPA2 Personal.

Dimensional Specifications

Dimensions [*]	Width: 288 mm (11.3 inches) Depth: 88.5 mm (3.5 inches) Height: 67 mm (2.6 inches)
Weight	Approx. 1.3 kg (2.9 lb)

* Without protruding parts.

Electrical Specifications

Scanner Electrical Specifications

Rated DC Input Power Supply Voltage	DC 5 V
Rated DC Input Current	3 A

Technical Specifications

Power Consumption *	USB Connection <input type="checkbox"/> Operating: Approx. 8 W <input type="checkbox"/> Ready mode: Approx. 3 W <input type="checkbox"/> Sleep mode: Approx. 1.2 W <input type="checkbox"/> Power off: 0.3 W or below Wi-Fi Connection <input type="checkbox"/> Operating: Approx. 10 W <input type="checkbox"/> Ready mode: Approx. 4.3 W <input type="checkbox"/> Sleep mode: Approx. 2.5 W <input type="checkbox"/> Power off: 0.3 W or below
---------------------	---

* When the battery is fully charged.

AC Adapter Electrical Specifications

Model	A491H (AC 100-240 V) A492E (AC 220-240 V)
Rated Input Current	0.6 A
Rated Frequency Range	50-60 Hz
Rated Output Power Supply Voltage	DC 5 V
Rated Output Current	3 A

Note:

For European users, see the following Website for details on power consumption.

<http://www.epson.eu/energy-consumption>

Battery Specifications

Type	Li-ion
Rated Voltage	3.6 V
Rated Capacity	2090mAh
Charging Time	<input type="checkbox"/> AC Adapter: Approx. 3 hours <input type="checkbox"/> USB 3.0 Port: Approx. 4 hours* <input type="checkbox"/> USB 2.0 Port: Approx. 20 hours*

* These values are measured under the condition that the scanner is turned on. If the scanner is off, charging takes longer.

Technical Specifications

Environmental Specifications

Temperature	When operating	5 to 35 °C (41 to 95 °F)
	When charging	8 to 35 °C (47 to 95 °F)
	When stored	-20 to 60 °C (-4 to 140 °F)
Humidity	When operating	15 to 80% (without condensation)
	When stored	15 to 85% (without condensation)
Operating conditions		Ordinary office or home conditions. Avoid operating the scanner in direct sunlight, near a strong light source, or in extremely dusty conditions.

System Requirements

Windows	<p>Windows 10 (32-bit, 64-bit)</p> <p>Windows 8.1 (32-bit, 64-bit)</p> <p>Windows 8 (32-bit, 64-bit)</p> <p>Windows 7 (32-bit, 64-bit)</p> <p>Windows Vista (32-bit, 64-bit)</p> <p>Windows XP Professional x64 Edition Service Pack 2</p> <p>Windows XP (32-bit) Service Pack 3</p> <p>Windows Server 2012 R2</p> <p>Windows Server 2012</p> <p>Windows Server 2008 R2</p> <p>Windows Server 2008 (32-bit, 64-bit)</p> <p>Windows Server 2003 R2 (32-bit, 64-bit)</p> <p>Windows Server 2003 (32-bit, 64-bit) Service Pack 2</p>
Mac OS X *1 *2	<p>Mac OS X v10.11.x</p> <p>Mac OS X v10.10.x</p> <p>Mac OS X v10.9.x</p> <p>Mac OS X v10.8.x</p> <p>Mac OS X v10.7.x</p> <p>Mac OS X v10.6.8</p>

*1 Fast User Switching on Mac OS X or later is not supported.

*2 The UNIX File System (UFS) for Mac OS X is not supported.

Standards and Approvals

Standards and Approvals for U.S. Models

Product

EMC	FCC Part 15 Subpart B Class B CAN/CSA-CEI/IEC CISPR 22 Class B
-----	---

This equipment contains the following wireless module.

Manufacturer: Askey Computer Corporation

Type: WLU6117-D69 (RoHS)

This product conforms to Part 15 of the FCC Rules and RSS-210 of the IC Rules. Epson cannot accept responsibility for any failure to satisfy the protection requirements resulting from a non-recommended modification of the product. Operation is subject to the following two conditions: (1) this device may not cause harmful interference, and (2) this device must accept any interference received, including interference that may cause undesired operation of the device.

To prevent radio interference to the licensed service, this device is intended to be operated indoors and away from windows to provide maximum shielding. Equipment (or its transmit antenna) that is installed outdoors is subject to licensing.

This equipment complies with FCC/IC radiation exposure limits set forth for an uncontrolled environment and meets the FCC radio frequency (RF) Exposure Guidelines in Supplement C to OET65 and RSS-102 of the IC radio frequency (RF) Exposure rules. This equipment should be installed and operated so that the radiator is kept at least 7.9 inches (20 cm) or more away from a person's body (excluding extremities: hands, wrists, feet and ankles).

AC adapter (A491H)

Safety	UL60950-1 CAN/CSA-C22.2 No.60950-1
EMC	FCC Part 15 Subpart B Class B CAN/CSA-CEI/IEC CISPR 22 Class B

Standards and Approvals for European Models

Product and AC adapter

For European users

Hereby, Seiko Epson Corporation declares that the following radio equipment models are in compliance with Directive 2014/53/EU. The full text of the EU declaration of conformity is available at the following website.

<http://www.epson.eu/conformity>

J391A

A491H, A492E

Standards and Approvals

For use only in Ireland, UK, Austria, Germany, Liechtenstein, Switzerland, France, Belgium, Luxembourg, Netherlands, Italy, Portugal, Spain, Denmark, Finland, Norway, Sweden, Iceland, Croatia, Cyprus, Greece, Slovenia, Malta, Bulgaria, Czech, Estonia, Hungary, Latvia, Lithuania, Poland, Romania, and Slovakia.

Epson cannot accept responsibility for any failure to satisfy the protection requirements resulting from a non-recommended modification of the product.



Standards and Approvals for Australian Models

Product

EMC	AS/NZS CISPR22 Class B
-----	------------------------

Epson hereby declares that the following equipment Models are in compliance with the essential requirements and other relevant provisions of AS/NZS4268:

J391A

Epson cannot accept responsibility for any failure to satisfy the protection requirements resulting from a non-recommended modification of the product.

AC adapter (A491H)

Safety	AS/NZS 60950.1
EMC	AS/NZS CISPR22 Class B

Where to Get Help

Technical Support Web Site

If you need further help, visit the Epson support website shown below. Select your country or region and go to the support section of your local Epson website. The latest drivers, FAQs, manuals, or other downloadables are also available from the site.

<http://support.epson.net/>

<http://www.epson.eu/support> (Europe)

If your Epson product is not operating properly and you cannot solve the problem, contact Epson support services for assistance.

Contacting Epson Support

Before Contacting Epson

If your Epson product is not operating properly and you cannot solve the problem using the troubleshooting information in your product manuals, contact Epson support services for assistance. If Epson support for your area is not listed below, contact the dealer where you purchased your product.

Epson support will be able to help you much more quickly if you give them the following information:

- Product serial number
(The serial number label is usually on the back of the product.)
- Product model
- Product software version
(Click **About**, **Version Info**, or a similar button in the product software.)
- Brand and model of your computer
- Your computer operating system name and version
- Names and versions of the software applications you normally use with your product

Note:

Depending on the product, the dial list data for fax and/or network settings may be stored in the product's memory. Due to breakdown or repair of a product, data and/or settings may be lost. Epson shall not be responsible for the loss of any data, for backing up or recovering data and/or settings even during a warranty period. We recommend that you make your own backup data or take notes.

Help for Users in Europe

Check your Pan-European Warranty Document for information on how to contact Epson support.

Where to Get Help

Help for Users in Taiwan

Contacts for information, support, and services are:

World Wide Web

<http://www.epson.com.tw>

Information on product specifications, drivers for download, and products enquiry are available.

Epson HelpDesk

Phone: +886-2-80242008

Our HelpDesk team can help you with the following over the phone:

- Sales enquiries and product information
- Product usage questions or problems
- Enquiries on repair service and warranty

Repair service center:

<http://www.tekcare.com.tw/branchMap.page>

TekCare corporation is an authorized service center for Epson Taiwan Technology & Trading Ltd.

Help for Users in Australia

Epson Australia wishes to provide you with a high level of customer service. In addition to your product manuals, we provide the following sources for obtaining information:

Internet URL

<http://www.epson.com.au>

Access the Epson Australia World Wide Web pages. Worth taking your modem here for the occasional surf! The site provides a download area for drivers, Epson contact points, new product information and technical support (e-mail).

Epson Helpdesk

Phone: 1300-361-054

Epson Helpdesk is provided as a final backup to make sure our clients have access to advice. Operators on the Helpdesk can aid you in installing, configuring and operating your Epson product. Our Pre-sales Helpdesk staff can provide literature on new Epson products and advise where the nearest dealer or service agent is located. Many types of queries are answered here.

We encourage you to have all the relevant information on hand when you ring. The more information you prepare, the faster we can help solve the problem. This information includes your Epson product manuals, type of computer, operating system, application programs, and any information you feel is required.

Transportation of Product

Epson recommends retaining product packaging for future transportation.

Where to Get Help

Help for Users in Singapore

Sources of information, support, and services available from Epson Singapore are:

World Wide Web

<http://www.epson.com.sg>

Information on product specifications, drivers for download, Frequently Asked Questions (FAQ), Sales Enquiries, and Technical Support via e-mail are available.

Epson HelpDesk

Toll Free: 800-120-5564

Our HelpDesk team can help you with the following over the phone:

- Sales enquiries and product information
- Product usage questions or problem troubleshooting
- Enquiries on repair service and warranty

Help for Users in Thailand

Contacts for information, support, and services are:

World Wide Web

<http://www.epson.co.th>

Information on product specifications, drivers for download, Frequently Asked Questions (FAQ), and e-mail are available.

Epson Call Centre

Phone: 66-2685-9899

Email: support@eth.epson.co.th

Our Call Centre team can help you with the following over the phone:

- Sales enquiries and product information
- Product usage questions or problems
- Enquiries on repair service and warranty

Help for Users in Vietnam

Contacts for information, support, and services are:

Epson Service Center

65 Truong Dinh Street, District 1, Ho Chi Minh City, Vietnam.

Phone(Ho Chi Minh City): 84-8-3823-9239, 84-8-3825-6234

29 Tue Tinh, Quan Hai Ba Trung, Hanoi City, Vietnam

Where to Get Help

Phone(Hanoi City): 84-4-3978-4785, 84-4-3978-4775

Help for Users in Indonesia

Contacts for information, support, and services are:

World Wide Web

<http://www.epson.co.id>

- Information on product specifications, drivers for download
- Frequently Asked Questions (FAQ), Sales Enquiries, questions through e-mail

Epson Hotline

Phone: +62-1500-766

Fax: +62-21-808-66-799

Our Hotline team can help you with the following over the phone or fax:

- Sales enquiries and product information
- Technical support

Epson Service Center

Province	Company Name	Address	Phone E-mail
JAKARTA	Epson Sales and Service Jakarta (SUDIRMAN)	Wisma Keiai Lt. 1 Jl. Jenderal Sudirman Kav. 3 Jakarta Pusat - DKI JAKARTA 10220	021-5724335 ess@epson-indonesia.co.id; ess.support@epson-indonesia.co.id
SERPONG	Epson Sales and Service Serpong	Ruko Melati Mas Square Blok A2 No.17 Serpong-Banten	082120090084 / 082120090085 esstag@epson-indonesia.co.id; esstag.support@epson-indonesia.co.id
SEMARANG	Epson Sales and Service Semarang	Komplek Ruko Metro Plaza Block C20 Jl. MT Haryono No. 970 Semarang -JAWA TENGAH	024 8313807 / 024 8417935 esssmg@epson-indonesia.co.id; esssmg.support@epson-indonesia.co.id
JAKARTA	Epson Sales and Service Jakarta (MANGGA DUA)	Ruko Mall Mangga Dua No. 48 Jl. Arteri Mangga Dua, Jakarta Utara - DKI JAKARTA	021 623 01104 jkt-technical1@epson-indonesia.co.id; jkt-admin@epson-indonesia.co.id
BANDUNG	Epson Sales and Service Bandung	Jl. Cihampelas No. 48 A Bandung Jawa Barat 40116	022 420 7033 bdg-technical@epson-indonesia.co.id; bdg-admin@epson-indonesia.co.id

Where to Get Help

Province	Company Name	Address	Phone E-mail
MAKASSAR	Epson Sales and Service Makassar	Jl. Cendrawasih NO. 3A, kunjung mae, mariso, MAKASSAR - SULSEL 90125	0411- 8911071 mksr-technical@epson-indonesia.co.id; mksr-admin@epson-indonesia.co.id
MEDAN	Epson Service Center Medan	Jl. Bambu 2 Komplek Graha Niaga Nomor A-4, Medan - SUMUT	061- 42066090 / 42066091 mdn-technical@epson-indonesia.co.id; mdn-adm@epson-indonesia.co.id
PALEMBANG	Epson Service Center Palembang	Jl. H.M Rasyid Nawawi No. 249 Kelurahan 9 Ilir Palembang Sumatera Selatan	0711 311 330 escplg@epson-indonesia.co.id; escplg.support@epson-indonesia.co.id
PEKANBARU	Epson Service Center Pekanbaru	Jl. Tuanku Tambusai No. 459 A Kel. Tangkerang barat Kec Marpoyan damai Pekanbaru - Riau 28282	0761- 8524695 pkb-technical@epson-indonesia.co.id; pkb-admin@epson-indonesia.co.id
PONTIANAK	Epson Service Center Pontianak	Komp. A yani Sentra Bisnis G33, Jl. Ahmad Yani - Pontianak Kalimantan Barat	0561- 735507 / 767049 pontianak-technical@epson-indonesia.co.id; pontianak-admin@epson-indonesia.co.id
SAMARINDA	Epson Service Center Samarinda	Jl. KH. Wahid Hasyim (M. Yamin) Kelurahan Sempaja Selatan Kecamatan Samarinda UTARA - SAMARINDA - KALTIM	0541 7272 904 escsmd@epson-indonesia.co.id; escsmd.support@epson-indonesia.co.id
SURABAYA	Epson Sales & Service Surabaya (barat)	Jl. Haji Abdul Wahab Saimin, Ruko Villa Bukit Mas RM-11, Kec. Dukuh Pakis, Surabaya - 60225	031- 5120994 sby-technical@epson-indonesia.co.id; sby-admin@epson-indonesia.co.id
YOGYAKARTA	Epson Service Center Yogyakarta	YAP Square, Block A No. 6 Jl. C Simanjutak Yogyakarta - DIY	0274 581 065 ygy-technical@epson-indonesia.co.id; ygy-admin@epson-indonesia.co.id
JEMBER	Epson Service Center Jember	Jl. Panglima Besar Sudirman Ruko no.1D Jember-Jawa Timur (Depan Balai Penelitian & Pengolahan Kakao)	0331- 488373 / 486468 jmr-admin@epson-indonesia.co.id; jmr-technical@epson-indonesia.co.id
MANADO	EPSON SALES AND SERVICE Manado	Jl. Piere Tendean Blok D No 4 Kawasan Mega Mas Boulevard - Manado 95111	0431- 8805896 MND-ADMIN@EPSON-INDONESIA.CO.ID; MND-TECHNICAL@EPSON-INDONESIA.CO.ID
CIREBON	EPSON SERVICE CENTER Cirebon	Jl. Tuparev No. 04 (Depan Hotel Apita) Cirebon, JAWA BARAT	0231– 8800846 cbn-technical@epson-indonesia.co.id

Where to Get Help

Province	Company Name	Address	Phone E-mail
CIKARANG	EPSON SALES AND SERVICE CIKARANG	Ruko Metro Boulevard B1 Jababeka cikarang - Jawa Barat,	021- 89844301 / 29082424 ckg-admin@epson-indonesia.co.id; ckg-technical@epson-indonesia.co.id
MADIUN	EPSON SERVICE CENTER MADIUN	Jl. Diponegoro No.56, MADIUN - JAWA TIMUR	0351- 4770248 mun-admin@epson-indonesia.co.id ; mun-technical@epson-indonesia.co.id
PURWOKERTO	EPSON SALES AND SERVICE Purwokerto	Jl. Jendral Sudirman No. 4 Kranji Purwokerto - JAWA TENGAH	0281- 6512213 pwt-admin@epson-indonesia.co.id ; pwt-technical@epson-indonesia.co.id
BOGOR	EPSON SALES AND SERVICE Bogor	Jl.Pajajaran No 15B Kel Bantarjati Kec Bogor Utara - JAWA BARAT 16153	0251- 8310026 bgr-admin@epson-indonesia.co.id ; bgr-technical@epson-indonesia.co.id
SERANG	EPSON SERVICE CENTER Serang	Jl. Ahmad Yani No.45C, SERANG - BANTEN	0254- 7912503 srg-admin@epson-indonesia.co.id ; srg-technical@epson-indonesia.co.id
PALU	EPSON SALES AND SERVICE Palu	Jl. Juanda No. 58, Palu - Sulteng	0451- 4012 881 plw-admin@epson-indonesia.co.id; plw-technical@epson-indonesia.co.id
BANJARMASIN	EPSON SERVICE CENTER BANJARMASIN	Jl. Gatot Soebroto NO. 153 BANJARMASIN - KALSEL 70235	0511- 6744135 (TEKNISI) / 3266321 (ADMIN) bdj-admin@epson-indonesia.co.id; bdj-technical@epson-indonesia.co.id
DENPASAR	EPSON SALES AND SERVICE Denpasar	JL. MAHENDRADATA NO. 18, DENPASAR - BALI	0361- 3446699 / 9348428 dps-admin@epson-indonesia.co.id; dps-technical@epson-indonesia.co.id
JAKARTA	EPSON SALES AND SERVICE CILANDAK	CIBIS Business Park Tower 9 LT. MEZZANINE, Jalan TB Simatupang No.2, Jakarta Selatan - DKI JAKARTA 12560	021- 80866777 esscibis.support1@epson-indonesia.co.id; esscibis.support2@epson-indonesia.co.id; esscibis.admin@epson-indonesia.co.id; esscibis.sales@epson-indonesia.co.id

Where to Get Help

Province	Company Name	Address	Phone E-mail
SURABAYA	EPSON SALES AND SERVICE SURABAYA (GUBENG)	JL. RAYA GUBENG NO. 62, SURABAYA - JAWA TIMUR	031- 99444940 / 99446299 / 99446377 esssby@epson-indonesia.co.id; esssby.support@epson-indonesia.co.id
AMBON	EPSON SERVICE CENTER AMBON	Jl. Diponegoro No.37 (Samping Bank Mandiri Syariah) Kel.Ahusen, Kec.Sirimau - Ambon 97127	-

For other cities not listed here, call the Hot Line: 08071137766.

Help for Users in Hong Kong

To obtain technical support as well as other after-sales services, users are welcome to contact Epson Hong Kong Limited.

Internet Home Page

<http://www.epson.com.hk>

Epson Hong Kong has established a local home page in both Chinese and English on the Internet to provide users with the following information:

- Product information
- Answers to Frequently Asked Questions (FAQs)
- Latest versions of Epson product drivers

Technical Support Hotline

You can also contact our technical staff at the following telephone and fax numbers:

Phone: 852-2827-8911

Fax: 852-2827-4383

Help for Users in Malaysia

Contacts for information, support, and services are:

World Wide Web

<http://www.epson.com.my>

- Information on product specifications, drivers for download
- Frequently Asked Questions (FAQ), Sales Enquiries, questions through e-mail

Epson Call Centre

Phone: 1800-81-7349 (Toll Free)

Email: websupport@emsb.epson.com.my

Where to Get Help

- Sales enquiries and product information
- Product usage questions or problems
- Enquiries on repair services and warranty

Head Office

Phone: 603-56288288

Fax: 603-5628 8388/603-5621 2088

Help for Users in India

Contacts for information, support, and services are:

World Wide Web

<http://www.epson.co.in>

Information on product specifications, drivers for download, and products enquiry are available.

Helpline

- Service, product information, and ordering consumables (BSNL Lines)
Toll-free number: 18004250011
Accessible 9am to 6pm, Monday through Saturday (Except public holidays)
- Service (CDMA & Mobile Users)
Toll-free number: 186030001600
Accessible 9am to 6pm, Monday through Saturday (Except public holidays)

Help for Users in the Philippines

To obtain technical support as well as other after sales services, users are welcome to contact the Epson Philippines Corporation at the telephone, fax numbers and e-mail address below:

World Wide Web

<http://www.epson.com.ph>

Information on product specifications, drivers for download, Frequently Asked Questions (FAQ), and E-mail Enquiries are available.

Epson Philippines Customer Care

Toll Free: (PLDT) 1-800-1069-37766

Toll Free: (Digital) 1-800-3-0037766

Metro Manila: (632) 8441 9030

Web Site: <https://www.epson.com.ph/contact>

E-mail: customercare@epc.epson.com.ph

Accessible 9am to 6pm, Monday through Saturday (Except public holidays)

Where to Get Help

Our Customer Care team can help you with the following over the phone:

- Sales enquiries and product information
- Product usage questions or problems
- Enquiries on repair service and warranty

Epson Philippines Corporation

Trunk Line: +632-706-2609

Fax: +632-706-2663