



AL-M320DN/AL-M310DN/AL-M220DN

User's Guide

NPD5658-00 EN

Contents

Contents

Introduction

Where to Find Information.	5
Warning, Caution, Important and Note.	5
Prerequisites of Description in This Manual.	5
Abbreviations of Operating Systems.	5
Note For This Publication.	6

Important Instructions

Important Safety Instructions.	7
Setting up the printer.	7
Finding the place for the printer.	8
Using the printer.	8
Handling the consumable products and maintenance parts.	9
Safety Information.	10
Laser safety labels.	10
Internal laser radiation.	10
Ozone safety.	10
Restrictions on Making Copies.	10
Making copies of the following items is prohibited by law.	11
Exercise caution when making copies of the following items.	11
Responsible use of copyrighted materials.	11

Getting to Know Your Printer

Printer Parts.	12
Front and right side view.	12
Inside the printer.	12
Rear view.	12
Control Panel for AL-M320DN/AL-M310DN	14
Control Panel for AL-M220DN.	15
Using the Control Panel.	17
When to make control panel settings.	17
How to access the control panel menus (AL-M320DN/AL-M310DN).	17
How to access the control panel menus (AL-M220DN).	17
Language.	19
System Information.	19
Quick Print JobMenu (AL-M320DN/AL-M310DN only).	20

ConfidentialJobMenu (AL-M320DN/AL-M310DN only).	20
Common Settings.	21
Printer Settings.	28
Admin Settings.	38
Bookmark Menu (For AL-M320DN/AL-M310DN).	39

Loading Paper

Available Paper and Capacities.	40
Available paper types and weights.	42
Loading Paper.	44
Paper cassette.	44
MP tray.	45
Paper Output Settings.	46
Orientation to eject paper.	46
Selecting and Using Print Media.	46
Envelopes.	46
Other paper.	47
Custom paper size.	47

Printing Tasks

Basics of Printing.	49
Setting the Main Screen.	50
Setting the More Options Screen.	51
Setting the Maintenance Screen.	53
Setting Advanced Features.	54
Printing multiple print jobs at one time.	54
Printing a booklet.	54
Printing data for a single page across multiple sheets (poster printing).	55
Using the Reserve Job function (AL-M320DN/AL-M310DN).	57
Printing with an overlay.	58
Improving the clarity of color documents.	59
Making Printer Settings (AL-M220DN only).	59
Using Sleep Mode to Save Energy.	59
Entering the sleep mode manually (For AL-M320DN/AL-M310DN).	60
Entering the sleep mode automatically.	60
Changing the Printer Driver's Default Settings (for Administrators).	61
Changing the default settings.	61
Locking the default settings.	61
Using EPSON Status Monitor.	61

Contents

Accessing EPSON Status Monitor.	61	The ready light is on.	92
Notice Settings.	62	Printout Problems.	93
Tray Icon Settings.	62	Print quality is poor.	93
Canceling a Print Job.	62	The printout is not what you expected.	94
From the printer.	62	Printing in the PS3 Mode Problems.	95
From the computer.	63	The printer does not print correctly in the PostScript mode.	96
Uninstalling and Installing Software		The printer does not print.	96
Uninstalling Software.	64	The printer or its driver does not appear in utilities in the printer configuration (Mac OS only).	96
Installing Software.	64	The font on the printout is different from that on the screen.	96
Installing the PostScript printer driver with Windows.	65	The edges of texts and/or images are not smooth.	97
Installing the PostScript printer driver with Mac OS.	66	The printer does not print normally via the USB interface.	97
Installing the PCL printer driver (For Windows only).	67	The printer does not print normally via the network interface.	97
		An undefined error occurs (Mac OS only).	97
Maintaining the Printer		Other Problems.	98
Replacing Consumable Products/Maintenance Parts.	68	The optional product is not available.	98
Precautions during replacement.	68	Correcting USB problems.	98
Replacement Messages/Lights.	68	Cannot access the shared printer.	99
Cleaning the Printer.	70	Transporting the Printer.	100
Cleaning the inner roller.	70	For short distances.	100
		For long distances.	100
Troubleshooting		Installing Options (AL-M320DN/AL-M310DN)	101
Status and Error Messages on the Control Panel (for AL-M320DN/AL-M310DN).	72	Optional paper cassette unit.	101
Status and Error Lights (for AL-M220DN).	78	Appendix	
Printing a Status Sheet.	84	Technical Specifications.	103
Printing from the control panel (For AL- M320DN/310DN).	84	General.	103
Printing from the control panel (For AL- M220DN).	84	Electrical.	105
Clearing Jammed Paper.	84	Supported operating systems.	105
F (Cover F).	85	Support Mode Settings using the control panel	105
E (Cover E).	87	Consumable Products and Options.	109
C1 DM (Cassette1/DM knob).	88	Consumable products.	109
MP (MP tray).	88	Options.	109
C1 - C3 (Cassette 1 - 3).	89	Copyrights, Trademarks, and Licenses.	110
Paper Does Not Feed Properly.	90	SOFTWARE LICENSE.	110
Power and Control Panel Problems.	90	Standard and Approvals.	110
The ready light does not turn on.	90	Where To Get Help	
The printer turns off automatically.	91	Contacting Epson Support.	111
The Printer does not turn off.	91	Before Contacting Epson.	111
The Printer Does Not Print.	92		
Ready light is off.	92		

Contents

Help for Users in Europe.	111
Help for Users in Taiwan.	111
Help for Users in Singapore.	112
Help for Users in Thailand.	112
Help for Users in Vietnam.	113
Help for Users in Indonesia.	113
Help for Users in Hong Kong.	115
Help for Users in Malaysia.	115
Help for Users in the Philippines.	116

Introduction

Introduction

Where to Find Information

❑ Setup Guide

Provides you with information on assembling the printer and installing the printer software.

❑ Password Setup Sheet (for AL-M320DN/AL-M310DN)

Provides you with information on how to set a password for the printer. When using it as a network printer, an administrator password must be set for the printer.

❑ IP Address and Password Setup Sheet (for AL-M220DN)

Provides you with information on how to set an IP Address and password. When using it as a network printer, an administrator password must be set for the printer. This sheet provides you with information on how to set a password for the printer.

❑ User's Guide (this manual)

Provides you with detailed information on the printer's functions, optional products, maintenance, troubleshooting, and technical specifications.

❑ Network Guide

Provides network administrators with information on both the printer driver and network settings.

❑ Font Guide

Provides you with information on fonts used on the printer. There are two font guides for the printer. Confirm the printer's internal fonts by printing the font list from *System Report*, and see the appropriate *font guide*.

❑ Online Help for printer software

Click **Help** for detailed information and instructions on the printer software that controls

your printer. Online help is automatically installed when you install the printer software.

Warning, Caution, Important and Note

**Warning**

must be followed carefully to avoid serious bodily injury.

**Caution**

must be observed to avoid bodily injury.

**Important**

must be observed to avoid damage to your equipment.

Note

contains important information and useful tips on the operation of your printer.

Prerequisites of Description in This Manual

The following illustrations and screenshots are used in this guide unless otherwise indicated.

❑ AL-M320DN

❑ Windows 7

The PostScript used on this printer is compatible with PostScript Level 3.

Abbreviations of Operating Systems

In this manual, the following abbreviations are used.

Windows 10

Microsoft® Windows® 10 Operating System

Introduction

Windows 8.1	Microsoft® Windows® 8.1 Operating System
Windows 8	Microsoft® Windows® 8 Operating System
Windows 7	Microsoft® Windows® 7 Operating System
Windows Vista	Microsoft® Windows Vista® Operating System
Windows XP	Microsoft® Windows® XP Operating System
Windows Server 2016	Microsoft® Windows Server® 2016 Operating System
Windows Server 2012 R2	Microsoft® Windows Server® 2012 R2 Operating System
Windows Server 2012	Microsoft® Windows Server® 2012 Operating System
Windows Server 2008 R2	Microsoft® Windows Server® 2008 R2 Operating System
Server 2008	Microsoft® Windows Server® 2008 Operating System
Server 2003	Microsoft® Windows Server® 2003 Operating System
Windows	Generic name of operating systems above

Mac OS X v10.12.x	macOS Sierra
Mac OS X v10.11.x	OS X El Capitan
Mac OS X v10.10.x	OS X Yosemite
Mac OS X v10.9.x	OS X Mavericks
Mac OS X v10.8.x	OS X Mountain Lion
Mac OS X v10.7.x	OS X Lion
Mac OS X v10.6.8	OS X Snow Leopard
Mac OS	Generic name of operating systems above

Note For This Publication

No part of this publication may be reproduced, stored in a retrieval system, or transmitted in any form or by any means, mechanical, photocopying, recording, or otherwise, without the prior written permission of Seiko Epson Corporation. No patent liability is assumed with respect to the use of the information contained herein. Neither is any liability assumed for damages resulting from the use of the information contained herein.

Neither Seiko Epson Corporation nor its affiliates shall be liable to the purchaser of this product or third parties for damages, losses, costs, or expenses incurred by purchaser or third parties as a result of: accident, misuse, or abuse of this product or unauthorized modifications, repairs, or alterations to this product, or (excluding the U.S.) failure to strictly comply with Seiko Epson Corporation's operating and maintenance instructions.

Seiko Epson Corporation and its affiliates shall not be liable against any damages or problems arising from the use of any options or any consumable products other than those designated as Original Epson Products or Epson Approved Products by Seiko Epson Corporation.

Important Instructions

Important Instructions

Important Safety Instructions

Setting up the printer

- Be sure to lift the printer by the correct positions as shown below.

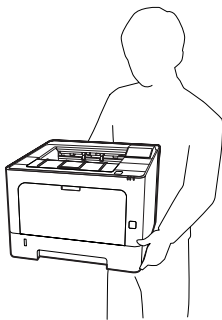

- When moving the printer, always keep it horizontal.
- If you are unable to insert the AC plug into the electrical outlet, contact an electrician.
- Do not connect to an uninterruptible power source. If you connect to one, it may cause malfunctions or damage.
- Be sure the AC power cord meets the relevant local safety standards. Use only the power cord that comes with this product. Use of another cord may result in fire or electric shock. This product's power cord is for use with this product only. Use with other equipment may result in fire or electric shock.
- If damage occurs to the plug, replace the cord set or consult a qualified electrician. If there are fuses in the plug, make sure you replace them with fuses of the correct size and rating.
- Use a grounded outlet that matches the printer's power plug. Do not use an adapter plug.
- Avoid using an electrical outlet that is controlled by wall switches or automatic timers. Accidental disruption of power can erase valuable information in your computer's and printer's memory.

- Make sure that there is no dust on the socket.
- Be sure to insert the plug completely into the electrical outlet.
- Do not handle the plug with wet hands.
- Unplug this printer from the wall outlet and refer servicing to a qualified service representative under the following conditions:

A.	When the power cord or plug is damaged or frayed.
B.	If liquid has been spilled into it.
C.	If it has been exposed to rain or water.
D.	If it does not operate normally when the operating instructions are followed. Adjust only those controls that are covered by the operating instructions since improper adjustment of other controls may result in damage and will often require extensive work by a qualified technician to restore the product to normal operation.
E.	If it has been dropped or the cabinet has been damaged.
F.	If it exhibits a distinct change in performance, indicating a need for service.

- Avoid sharing outlets with other appliances.
- Connect all equipment to properly grounded power outlets. Avoid using outlets on the same circuit as photocopiers or air control systems that regularly switch on and off.
- Connect your printer to an electrical outlet that meets the power requirements of this printer. Your printer's power requirements are indicated on a label attached to the printer. If you are not sure of the power supply specifications in your area, contact your local power company or consult your dealer.
- If you use an extension cord, make sure that the total of the ampere ratings on the products plugged into the extension cord does not exceed the extension cord ampere rating.

Important Instructions

- ❑ When connecting this product to a computer or other device with a cable, ensure the correct orientation of the connectors. Each connector has only one correct orientation. Inserting a connector in the wrong orientation may damage both devices connected by the cable.
- ❑ Use only optional products, such as the paper cassette units and the printer stand, produced specifically for this product. Using options produced for other products may cause the product to fall over and injure someone.

Finding the place for the printer

When relocating the printer, always choose a location that has adequate space for easy operation and maintenance. Use the following illustration as a guide for the amount of space required around the printer to ensure smooth operation.

Note:

Figures are rounded off to the nearest whole number.

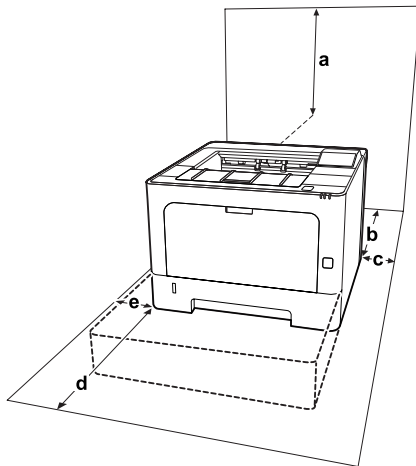

a	20 cm	d	50 cm
b	30 cm	e	30 cm
c	30 cm		

In addition to space considerations, always heed the following precautions when finding a place to locate the printer:

- ❑ Place the printer near an electrical outlet where you can easily plug in and unplug the power cord.
- ❑ Do not put your printer where the cord will be stepped on.
- ❑ Do not use printer in a damp environment.
- ❑ Avoid locations that are subject to direct sunlight, excessive heat, moisture, oil vapor, or dust.
- ❑ Avoid locations that are subject to the air coming directly from an air conditioner.
- ❑ Do not place the printer on an unstable surface.
- ❑ Slots and openings in the cabinet and the back or bottom are provided for ventilation. Do not block or cover them. Do not put the printer on a bed, sofa, rug, or other similar surface or in a built-in installation unless proper ventilation is provided.
- ❑ Keep the entire computer and printer system away from potential sources of interference, such as loudspeakers or the base units of cordless telephones.
- ❑ Leave adequate room around the printer to allow for sufficient ventilation.

Using the printer

- ❑ Some of the symbols used on your printer are to ensure safety and proper use of the printer. Visit the following web site to learn the meaning of the symbols:
<http://support.epson.net/symbols/>
- ❑ Be careful not to touch the fuser, which is marked with a caution label, or the surrounding areas. If the printer has been in use, the fuser and the surrounding areas may be very hot. If you must touch one of these areas, wait 40 minutes to allow the heat to subside before doing so.

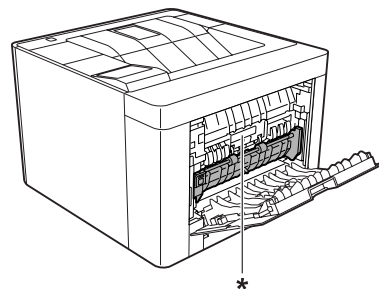

* caution label

Important Instructions

- ❑ Do not insert your hand deep into the fuser unit as some components are sharp and may cause injury.
- ❑ Never push objects of any kind through cabinet slots as they may touch dangerous voltage points or short out parts that could result in a risk of fire or electric shock.
- ❑ Do not sit or lean on the printer. Do not put heavy objects on the printer.
- ❑ Do not use any kind of combustible gases in or around the printer.
- ❑ Never force the printer's components into place. Although the printer is designed to be sturdy, rough handling can damage it.
- ❑ Do not leave jammed paper inside the printer. This can cause the printer to overheat.
- ❑ Never spill liquid of any kind on the printer.
- ❑ Adjust only those controls that are covered by the operating instructions. Improper adjustment of other controls may result in damage and may require repair by a qualified service representative.
- ❑ Do not turn off the printer:
 - After turning on the printer, wait until **Ready** appears on the LCD panel (AL-M320DN/AL-M310DN), or the Ready light turns on (AL-M220DN).
 - While the Data light is on or flashing.
 - While printing.
- ❑ Avoid touching the components inside the printer unless instructed to do so in this guide.
- ❑ Follow all warnings and instructions marked on the printer.
- ❑ Except as specifically explained in the printer's documentation, do not attempt to service this product yourself.
- ❑ Periodically disconnect the plug from the electrical outlet and clean the blades.
- ❑ Do not disconnect the plug while the printer is on.
- ❑ If the printer will not be used for a long time, disconnect the plug from the electrical outlet.
- ❑ Unplug this printer from the wall outlet before cleaning.

- ❑ Use a well-wrung cloth for cleaning and do not use liquid or aerosol cleaners.

Handling the consumable products and maintenance parts

- ❑ Do not burn used consumable products and maintenance parts because they might explode and injure someone. Dispose of them according to local regulations.
- ❑ Be sure to keep consumable products and maintenance parts out of the reach of children.
- ❑ When handling a toner cartridge, always place it on a clean, smooth surface.
- ❑ Do not attempt to modify or take it apart consumable products and maintenance parts.
- ❑ Do not touch the toner. Always keep toner away from your eyes. If toner gets on your skin or clothes, wash it off with soap and water immediately.
- ❑ If toner is spilled, use a broom and dustpan or a damp cloth with soap and water to clean it up. Because the fine particles can cause a fire or explosion if they come into contact with a spark, do not use a vacuum cleaner.
- ❑ Wait at least one hour before using a toner cartridge or photoconductor after moving it from a cool to a warm environment to prevent damage from condensation.
- ❑ To get the best print quality, do not store the toner cartridge in an area subject to direct sunlight, dust, salty air, or corrosive gases (such as ammonia). Avoid locations subject to extreme or rapid changes in temperature or humidity.
- ❑ When removing the photoconductor unit, do not expose it to sunlight at all and avoid exposing it to room light for more than three minutes. The photoconductor unit contains a light-sensitive drum. Exposure to light can damage the drum, causing dark or light areas to appear on the printed page and reducing the service life of the drum. If you need to keep the photoconductor unit out of the printer for long periods, cover it with an opaque cloth.

Important Instructions

- Be careful not to scratch the surface of the drum. When you remove the photoconductor unit from the printer, always place it on a clean, smooth surface. Avoid touching the drum, since oil from your skin can permanently damage its surface and affect print quality.
- Do not touch the transfer roller to avoid damaging it.
- Do not let the paper's edge slide across your skin because the edge of the paper may cut you.

Safety Information

Laser safety labels



Warning:

The performance of procedures and adjustments other than those specified in the printer's documentation may result in hazardous radiation exposure. Your printer is a Class 1 laser product as defined in the IEC60825 specifications. The label similar to the one shown below is attached to the back of the printer in countries where required.



Internal laser radiation

There is a Class III b Laser Diode Assembly that has an invisible laser beam inside the printer head unit. The printer head unit is NOT A SERVICE ITEM, therefore, the printer head unit should not be opened under any circumstances. An additional laser warning label is affixed to the inside of the printer.

Ozone safety

Ozone emission

Ozone gas is generated by laser printers as a by-product of the printing process. Ozone is produced only when the printer is printing.

Ozone exposure limit

The Epson laser printer generates less than 1.5 mg/h of continuous printing.

Minimize the risk

To minimize the risk of exposure to ozone, you should avoid the following conditions:

- Use of multiple laser printers in a confined area
- Operation in conditions of extremely low humidity
- Poor room ventilation
- Long, continuous printing together with any of the above

Printer location

The printer should be located so that the exhaust gases and heat generated are:

- Not blown directly into the user's face
- Vented directly out of the building whenever possible

Restrictions on Making Copies

Observe the following restrictions in order to ensure the responsible and legal use of this printer.

Important Instructions

Making copies of the following items is prohibited by law

- Bank bills, coins, government-issued marketable securities, government bond securities, and municipal securities
- Unused postage stamps, pre-stamped postcards, and other official postal items bearing valid postage
- Government-issued revenue stamps, and securities issued according to legal procedure

Exercise caution when making copies of the following items

- Private marketable securities (stock certificates, negotiable notes, checks, etc.), monthly passes, concession tickets, etc.
- Passports, driver's licenses, warrants of fitness, road passes, food stamps, tickets, etc.

Responsible use of copyrighted materials

The printer may be used mistakenly or improperly to illegally copy copyrighted materials. You must act responsibly when copying copyrighted materials; by acquiring the permission of the copyright holder or acting on the advice of a knowledgeable attorney.

Getting to Know Your Printer

Getting to Know Your Printer

Printer Parts

Front and right side view

AL-M320DN/AL-M310DN

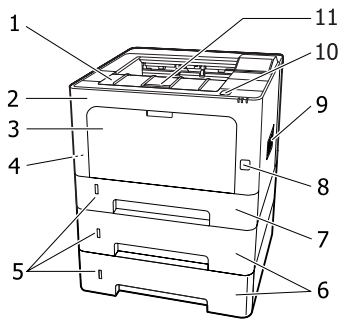

AL-M220DN

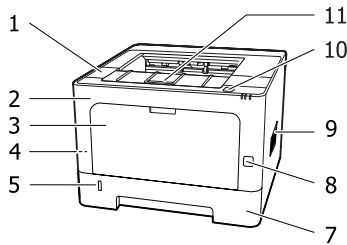

1.	cover F2
2.	cover F1
3.	MP tray
4.	security slot
5.	window for knowing the remaining amount of paper
6.	cassette 2/3 (optional paper cassette)
7.	cassette 1 (standard paper cassette)
8.	power switch
9.	ventilation window
10.	button to open covers F1 and F2

11.	paper support
-----	---------------

Inside the paper cassette

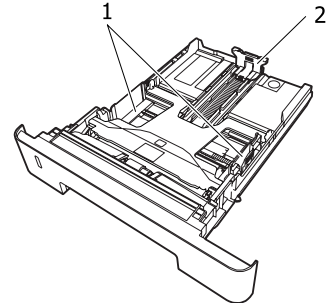

1.	paper guide (side guide)
2.	paper guide (back guide)

Inside the printer

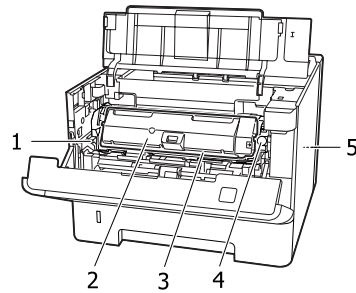

1.	lever to remove maintenance unit A
2.	toner cartridge
3.	maintenance unit A
4.	lock release button for toner cartridge
5.	maintenance unit B

Rear view

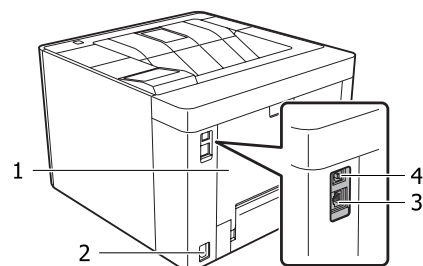

Getting to Know Your Printer

1.	cover E
2.	AC inlet
3.	Ethernet interface connector LED1: data light LED2: status light For the information that the lights indicate, see the table below.
4.	USB interface connector

LED Status

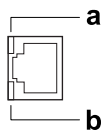

a: LED1	b: LED2	Network Status
Yellow	Green	Ready (1000BASE-T)
Yellow (Flashing)	Green	Receiving packets (1000BASE-T)
Yellow	Orange	Ready (100BASE-TX)
Yellow (Flashing)	Orange	Receiving packets (100BASE-TX)
Yellow	Off	Ready (10BASE-Te)
Yellow (Flashing)	Off	Receiving packets (10BASE-Te)
Off	Green	Deep sleep mode* (1000BASE-T)
Off	Off	Deep sleep mode* (100BASE-TX/10BASE-Te) Power off mode*

* See "Energy Saver Menu" on page 25 for details.

Getting to Know Your Printer

Control Panel for AL-M320DN/AL-M310DN

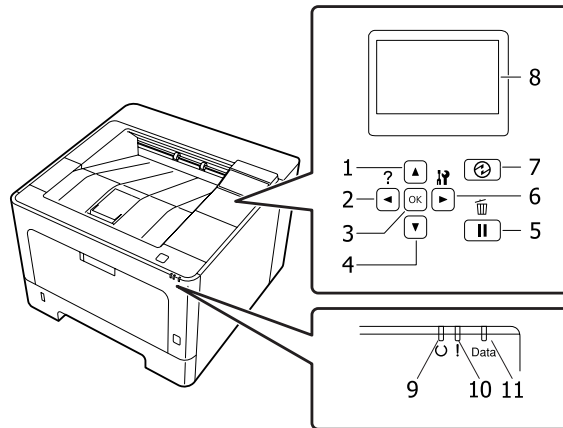

1.	▲ Up button	Press to scroll the items on the control panel menus.
2.	◀ Left button	Press to go back to the previous menu, or press to show the help if <code>◀Press for help</code> is displayed.
3.	OK button	Press to set the menu, item or setting. When the error light is flashing, pressing this button clears the error and switches the printer to ready status.
4.	▼ Down button	Press to scroll the items on the control panel menus.
5.	Pause/Release button	Press once to pause. Press again to recover from pause. While paused, the following operations are available on the control panel. <ul style="list-style-type: none"> <input type="checkbox"/> Canceling the current print job or stored print jobs. See "Cancelling a Print Job" on page 62. <input type="checkbox"/> Interrupting print jobs to print a stored print job. <input type="checkbox"/> Ejecting a paper (Form Feed) by holding down the OK button for more than 2 seconds.
6.	▶ Right button	Press to go to the next menu, item or setting.
7.	Wakeup/Sleep button	Press to switch the status between available for printing and saving power. This button lights up when the printer is in the sleep mode (the deep sleep mode). This button blinks when the printer enters the power off mode, which saves power because almost all functions are not available. For more details about the power off mode, see "Energy Saver Menu" on page 25.
8.	LCD panel	Displays printer status messages and control panel menu settings.
9.	Ready light	On when the printer is ready, indicating that the printer is ready to receive and print data. Off when the printer is not ready, or in the sleep mode.
10.	Error light (Orange)	On or flashes when an error has occurred. Pressing the OK button or <code>Auto Cont</code> setting in the <code>Setup Menu</code> clears the errors that are flashing.

Getting to Know Your Printer

11.	Data light	On when print data is stored in the print buffer (the section of printer memory reserved for receiving data) but not yet printed. Flashes when the printer is processing data. Off when no data remains in the print buffer.
-----	-------------------	--

Control Panel for AL-M220DN

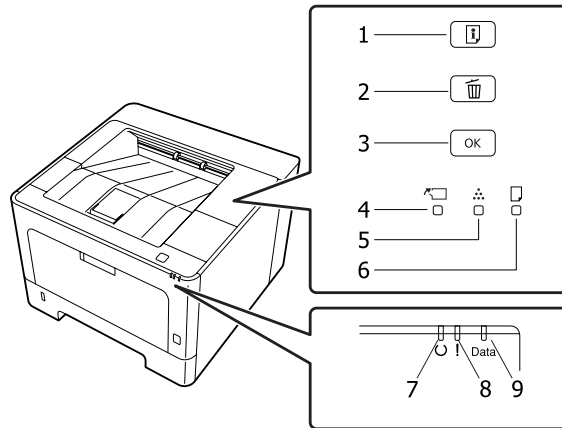

1.	Information button	Prints status sheets when the Error light is off and no warning is indicated. Prints a status sheet when pressed once. Pressing this button for more than two seconds prints a network status sheet. Clears the warning when a warning is indicated.
2.	Job Cancel button	Press once to cancel the current print job. Press and hold for more than two seconds to delete all jobs from the printer memory.
3.	OK button	When the error light is flashing, pressing this button clears the error and switches the printer to ready status.
4.	Cover & Maintenance light	Lit when the printer's cover is open, or when an error related to consumable products or maintenance parts other than toner occurred. Flashes when a warning related to these occurred.
5.	Toner light	On when the printer's toner cartridge has run out of toner. Flashes to indicate that toner is running low. If this light is flashing, have a new toner cartridge ready.
6.	Paper light	Turns on or flashes, and when in combination with the Error light, usually indicates a paper-related problem. On usually indicates a paper jam, while flashing usually indicates a paper-related error or warning, such as when the paper source is empty.
7.	Ready light	On when the printer is ready, indicating that the printer is ready to receive and print data. Off when the printer is not ready. This light also comes on in combination with other lights to indicate error situations.
8.	Error light (Orange)	On or flashes when an error has occurred.
9.	Data light	On when print data is stored in the print buffer (the section of printer memory reserved for receiving data) but not yet printed. Flashes when the printer is processing data. Off when no data remains in the print buffer.

Getting to Know Your Printer

Note:

- When the printer is in sleep or deep sleep mode, all lights are off. When in sleep or deep sleep mode, pressing any button returns the printer to the ready state.
- For details about LED light statuses, see [“Status and Error Lights \(for AL-M220DN\)”](#) on page 78.

Getting to Know Your Printer

Using the Control Panel

When to make control panel settings

In general, printer driver settings override settings made using the control panel.

You should make the following settings by using the control panel because these settings cannot be made in the printer driver.

- Settings to select emulation modes and IES (Intelligent Emulation Switching) mode
- Settings to specify a channel and configure the interface
- Settings to specify the size of the memory buffer used to receive data

For AL-M220DN, which does not have an LCD panel, you can do the control panel settings using EpsonNet Config. See [“How to access the control panel menus \(AL-M220DN\)”](#) on page 17.

How to access the control panel menus (AL-M320DN/AL-M310DN)

Note:

Some menus and items appear only when a corresponding optional device is installed or an appropriate setting has been done.

- 1** Press the **▶ Right** button to access the control panel menus.

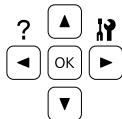

- 2** Use the **▲ Up** and **▼ Down** buttons to scroll through the menus.

- 3** Press the **▶ Right** button to view the items in a menu. Depending on the menu, the LCD panel displays an item and the current setting separated (**▲YYY=ZZZZ**), or only an item (**▲YYY**).

- 4** Use the **▲ Up** and **▼ Down** buttons to scroll through the items, or press the **◀ Left** button to return to the previous level.

- 5** Press the **▶ Right** button to carry out the operation indicated by an item, such as printing a configuration status sheet or resetting the printer, or to view the settings available for an item, such as paper sizes or emulation modes.

Use the **▲ Up** and **▼ Down** buttons to scroll through available settings, then press the **▶ Right** button to select a setting and return to the previous level. Press the **◀ Left** button to return to the previous level without changing the setting.

Note:

- You need to turn the printer off and then on to activate the settings you changed in the Network Menu, USB Menu or RAM Disk in the Setup Menu.
- The OK button can be used instead of the **▶ Right** button in step 3 or 5.

- 6** Press the **◀ Left** button once or more times to exit the control panel menus.

How to access the control panel menus (AL-M220DN)

Although there are no panels that can display menus, you can do settings that correspond to the operation panel menus from a computer that is connected to the printer. You can do the settings using the following procedure.

From EpsonNet Config (web version)

You can do settings when the printer is connected to the network.

The method to open the settings screen is shown below.

Getting to Know Your Printer

- 1 Connect the printer to the same network as your computer.

Note:

See the following manuals for how to connect the printer to the network.

- Setup Guide
- IP Address and Password Setup Sheet

- 2 Enter the printer's IP address into the address bar of your web browser.

From the printer driver

You can set the following items that you think you will use often as printer settings, whether the printer is connected via USB or a network.

- MP Tray Size / MP Tray Type
- Cassette1 Size / Cassette1 Type
- Density
- Emphasize Thin Lines
- Paper Source
- Wide A4
- MP Tray Priority
- Page Protect
- Auto Eject Page
- I/F Time Out
- Size Ignore
- Time Setting
- Auto Cont
- Time to Sleep
- Language (Status Sheet)

Note:

For references for the corresponding control panel menus, see the following sections.

- "Tray Menu" on page 28
- "Printing Menu" on page 29
- "Setup Menu" on page 21
- "Energy Saver Menu" on page 25

To open the screen to do settings, follow the steps below:

- 1 Access the printer driver's properties from Start -Devices and Printers.

- 2 Click the **Optional Settings** tab, and then click the **Printer Settings** button.

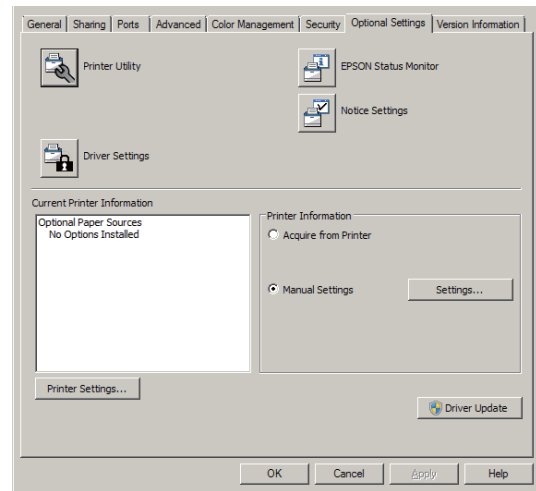

Note:

A warning appears if the time is not set after purchasing the printer. Use Printer Settings to set the time.

Getting to Know Your Printer

Language

Item	Explanation
Language	Specifies the language displayed on the LCD panel (AL-M320DN/AL-M310DN only) and that printed on the status sheet.
	Settings (default in bold): English , Français, Deutsch, Italiano, ESPAÑOL, SVENSKA, Dansk, Nederlands, SUOMI, Português, Norsk, CATALÀ, РУССКИЙ, Türkçe, Polski, Čeština, Magyar, Română, 中文, 繁體中文, 한국어

System Information

System Information

Note:

To use EpsonNet Config with a web browser to confirm settings, access **Information > System > System Information**.

Item	Explanation
Main Version	Displays the version of the firmware installed on each printer.
IPL Version	
MCU Version	
Serial No	Displays the serial number of each printer.
Memory	Displays the amount of memory of each printer.
MAC Address	Displays the MAC address of each printer.

System Report

Note:

To use EpsonNet Config with a web browser to print a report, access **Information > Confirmation**.

Item	Explanation
Print Configuration Status Sheet	Prints a sheet showing the current printer settings and installed options. This sheet can be useful to confirm whether option have been installed correctly.
Print Supplies Status Sheet	Prints a sheet showing information about consumables.
Print Usage History Sheet	Prints a sheet showing the history of the printer's usage.
Reserve Job List (AL-M320DN/AL-M310DN only)	Prints a list of reserved print jobs stored on the printer's memory. This item is available only when the jobs are stored by using the Quick Print Job feature.

Getting to Know Your Printer

Item	Explanation
Network Status Sheet	Prints a sheet showing the working status of the network. This item is available only when the Network I/F setting in Network Menu is set to On.
PS3 Font List	Prints a sample of the fonts available for your selected printer emulation.
PCL Font Sample	
ESCP2 Font Sample	
FX Font Sample	
I239X Font Sample	

Machine Status

Note:

To use EpsonNet Config with a web browser to do settings, access **Information > System > Machine status**.

Item	Explanation
Toner	The number of asterisks (*) between "E" and "F" indicates the remaining service lives of replacement parts. If a non-genuine replacement part is used, "?" is displayed instead of the indicator.
Fuser Unit Life (AL-M320DN only)	
Maintenance Unit A Life (AL-M320DN/AL-M310DN only)	
Maintenance Unit B Life (AL-M320DN/AL-M310DN only)	
Total Pages	Displays the total number of pages printed by the printer.

Quick Print JobMenu (AL-M320DN/AL-M310DN only)

This menu allows you to print or delete print jobs that were stored in the printer's memory using the Quick Print Job feature (Re-Print Job, Verify Job) of the printer driver's Reserve Job function. For instructions on using this menu, see ["Using the Reserve Job function \(AL-M320DN/AL-M310DN\)"](#) on page 57.

ConfidentialJobMenu (AL-M320DN/AL-M310DN only)

This menu allows you to print or delete print jobs stored in the printer's memory using the Confidential Job feature of the printer driver's Reserve Job function. You need to enter the correct password to access this data. For instructions on using this menu, see ["Using the Reserve Job function \(AL-M320DN/AL-M310DN\)"](#) on page 57.

Getting to Know Your Printer

Common Settings

Setup Menu

Note:

To use EpsonNet Config with a web browser to do settings, access **Configuration > Common Settings > Setup Menu**.

Item	Explanation
I/F Time Out	Specifies the length of the time, in seconds, before a time out when interfaces are being switched automatically. The time before a time out occurs is the length of time from the point when no data is being received from an interface until the point of switching the interface. If the printer has a print job when switching the interface, the printer prints the print job.
	Settings (default in bold): 0, 5 ... 60 ... 300 in increments of 1
MP Tray Priority	This setting determines whether the MP tray has the highest or lowest priority when Auto is selected as the Paper Source setting in the printer driver. When Normal (default) is selected as the MP Tray Priority, the MP tray has the highest priority as the paper source. If you select Last , the MP tray has the lowest priority.
Cassette Order (AL-M320DN/ AL-M310DN only)	Specifies the cassette order for feeding paper when the setting for the printer driver's Paper Source is Auto Select.
	Settings: Top>Bottom , Bottom>Top
Manual Feed	Allows you to select the manual feed mode for the MP tray.
	Settings (default in bold): Off , 1st Page, EachPage
Copies	Designates the number of copies to be printed, from 1 through 999.
Duplex	Turns duplex printing on or off. This allows you to print on both sides of a page. For the paper sizes for which duplex printing is available, see "Available Paper and Capacities" on page 40 .
	Settings (default in bold): Off, On
Binding	Specifies the binding direction of the printout. For the paper sizes for which duplex printing is available, see "Available Paper and Capacities" on page 40 .
	Settings (default in bold): Long Edge , Short Edge

Getting to Know Your Printer

Item	Explanation
Start Page	<p>Specifies whether duplex printing starts from the front or back of the page.</p> <p>For the paper sizes for which duplex printing is available, see “Available Paper and Capacities” on page 40.</p>
	<p>Settings (default in bold):</p> <p>Front, Back</p>
Skip Blank Page	<p>Enables you to skip blank pages when printing.</p> <p>This function is available only for ESCP2, FX, or I239X mode.</p>
	<p>Settings (default in bold):</p> <p>Off, On</p>
Auto Eject Page	<p>Specifies whether or not to eject paper when the limit specified in the I/F Time Out setting is reached. The default is Off, which means paper is not ejected when the time-out limit is reached.</p> <p>This function is not available in PS3 and PCL.</p>
	<p>Settings (default in bold):</p> <p>Off, On</p>
Size Ignore	<p>If you want to ignore a paper size error, select On. When you turn this item on, the printer keeps printing even if the image size exceeds the printable area for the specified paper size. This may cause smudges because of the toner that is not transferred onto the paper properly. When this item is turned off, the printer stops printing if a paper size error occurs.</p>
	<p>Settings (default in bold):</p> <p>Off, On</p>
Auto Cont	<p>When you turn this setting on, the printer automatically continues printing after a certain period of time when one of the following errors occurs: Set Paper, Print Overrun, or Memory Overflow. When this option is off, you must press the OK button to resume printing.</p>
	<p>Settings (default in bold):</p> <p>Off, On</p>
Page Protect	<p>Allocates additional printer memory for printing data, as opposed to receiving it. You may need to turn this setting on if you are printing a very complex page. If a Print Overrun error message appears on the LCD panel (AL-M320DN/AL-M310DN), or on the computer screen while printing, turn this setting on and reprint your data. This reduces the amount of memory reserved for processing data so your computer may take longer to send the print job, but it will allow you to print complex jobs. Page Protect usually works best when Auto is selected.</p> <p>Note:</p> <ul style="list-style-type: none"> <input type="checkbox"/> Changing the Page Protect setting reconfigures the printer's memory, which causes any downloaded fonts to be deleted. <input type="checkbox"/> This function is available only for ESCP2, FX, or I239X mode.
	<p>Settings (default in bold):</p> <p>Auto, On</p>

Getting to Know Your Printer

Item	Explanation
A4/LT Auto Switching	<p>If LT->A4 (or A4->LT) is selected, if letter (or A4) size paper is selected for printing but there is no paper source set to letter (or A4), the printout is output on A4 (or Letter).</p> <p>If A4<->LT is selected, if A4 or letter size paper is selected for printing but there is no paper source set to the selected paper size, the printout is output on the alternate paper size. (A4 for letter or letter for A4)</p> <p>Settings (default in bold): LT->A4, A4->LT, A4<->LT, Off</p>
LCD Contrast (AL-M320DN/ AL-M310DN)	<p>Adjusts the contrast of the LCD panel. Use the ▲ Up and ▼ Down buttons to set the contrast between 0 (lowest contrast) and 15 (highest contrast).</p> <p>Settings (default in bold): 0 ... 7 ... 15</p>
LCD Backlight (AL-M320DN/ AL-M310DN)	<p>If Auto is selected, the LCD backlight lights. Also, it turns off during Sleep or Deep Sleep mode. If Off is selected, the LCD backlight is always off.</p> <p>Settings (default in bold): Auto, Off</p>
RAM Disk (AL-M320DN/ AL-M310DN)	<p>Specifies the RAM disk size available for the Reserve Job function.</p> <p>After this item is changed, the setting value takes effect after a warm boot or after the power is turned on again.</p> <p>Settings (default in bold): Off, Normal, Maximum</p>
Convert to Simplex	<p>In the duplex printing mode, specifies whether to print the last page of a job in one side printing mode. Setting Odd Page or 1 Page can prevent the last page from being printed on an unexpected page when you are printing on preprinted paper or hole-punched paper.</p> <ul style="list-style-type: none"> <input type="checkbox"/> Odd Page: 1-page jobs or the last page of a job with an odd number of pages are printed in one side printing mode. <input type="checkbox"/> 1 Page: 1-page jobs are printed in one side printing mode. <input type="checkbox"/> Off: The last page of all jobs (including 1-page jobs or jobs with an odd number of pages) is printed in duplex printing mode.
Confirm Media Type	<p>Displays a message when the paper type in the tray selected for printing is different from that selected on Paper Type in the printer driver.</p> <p>Settings (default in bold): No, Yes</p>
Cassette Warning (AL-M320DN/AL-M310DN)	<p>Sets whether to display messages in the following situations when cassettes have been added.</p> <ul style="list-style-type: none"> - No cassette other than the lowest tray is inserted - A cassette other than the lowest tray has run out of paper <ul style="list-style-type: none"> <input type="checkbox"/> Off: Does not display <input type="checkbox"/> Warning: Indicates that there is no paper <input type="checkbox"/> Warning & Error: First, a message indicating to check the conditions of the cassettes appears. When the print data is received, it shows that the cassette has been pulled out, and the printer stops operating.

Getting to Know Your Printer

Item	Explanation
Job Information (M320DN/ M310DN)	<p>Selects the pattern in which the job information is displayed on the control panel. If Off is selected, no job information is displayed on the control panel, even if the Pause/Release button is pressed to cancel or skip a job.</p> <p>If Norsk, CATALÀ, РУССКИЙ, Türkçe, 中文, 繁體中文, or 한국어 is selected as Language when the printer is turned on for the first time after you purchase it, the default value is Off. If other language is selected, the default value is Display Pattern 1.</p> <p>Do not select Display Pattern 1 when the following languages are selected as Language: Norsk, CATALÀ, РУССКИЙ, Türkçe, 中文, 繁體中文, 한국어</p> <p>Settings: Display Pattern 1, Display Pattern 2, Off</p>
Local Time Diff.	<p>Specifies the current date and time by entering the time difference from Greenwich Mean time.</p> <p>Settings (default in bold): -14:00 ... 0:00 ... +14:00</p>
Time Setting	<p>Specifies the current date and time by entering them directly.</p> <p>Settings: 2010/ 01/01 00:00 to 2098/12/31 23:59</p>
Date Format	<p>Specifies the format to display the date.</p> <p>Settings (default in bold): DD/MM/YY, MM/DD/YY, YY/MM/DD</p>

USB Menu

<p>Note:</p> <ul style="list-style-type: none"> <input type="checkbox"/> After any item in the menu is changed, the setting takes effect after a warm boot or after the power is turned on again. While it is reflected in the Status Sheet, the actual change takes effect after a warm boot or after the power is turned on again. <input type="checkbox"/> To use EpsonNet Config with a web browser to do settings, access Configuration > Common Settings > USB Menu.
--

Item	Explanation
USB I/F	<p>Allows you to activate or deactivate the USB interface.</p> <p>Settings (default in bold): On, Off</p>
USB Speed	<p>Allows you to select the operation mode of USB interface. Selecting HS is recommended. Select FS if HS does not work on your computer system.</p> <p>Settings (default in bold): HS, FS</p>

Getting to Know Your Printer

Item	Explanation
Buffer Size	<p>Determines the amount of memory to be used for receiving data and printing data.</p> <p>Note:</p> <ul style="list-style-type: none"> <input type="checkbox"/> To activate Buffer Size settings, you must turn off the printer for more than five seconds then turn it back on. Or, you can perform a Reset All operation, as explained in Reset Menu. <input type="checkbox"/> Resetting the printer erases all print jobs. Make sure the Ready light is not flashing when you reset the printer.
	<p>Settings (default in bold):</p> <p>Normal, Maximum, Minimum</p>

Network Menu

See the *Network Guide* for each setting.

<p>Note:</p> <ul style="list-style-type: none"> <input type="checkbox"/> In order to do IP address settings for AL-M220DN's first setup, you must install EpsonNet Config for Windows or for Mac OS X. Note that you cannot do IP address settings using EpsonNet Config on a web browser for the first setup. For details, see the <i>IP Address and Password Setup Sheet</i>, and <i>Network Guide</i>. <input type="checkbox"/> After any item in the menu is changed, the setting takes effect after a warm boot or after the power is turned on again. While it is reflected in the <i>Status Sheet</i>, the actual change takes effect after a warm boot or after the power is turned on again.
--

Energy Saver Menu

<p>Note:</p> <p>To use EpsonNet Config with a web browser to do settings, access Configuration > Common Settings > Energy Saver Menu.</p>

Item	Explanation
Time to Sleep(Auto)	<p>When this setting is set to Enable, the printer automatically determines the time to enter the sleep or deep sleep mode, based on the operation history of the printer. Note if Enable is selected, the Time to Sleep and Eco Fuser settings are ignored.</p> <p>Settings (default in bold):</p> <p>Enable, Disable</p>
Time to Sleep	<p>Specifies the length of the time until the printer enters the sleep mode or deep sleep mode if there are no button operations and no jobs to be printed.</p> <p>Settings (default in bold):</p> <p>1Min, 3Min, 5Min, 15Min, 30Min, 60Min, 120Min</p>

Getting to Know Your Printer

Item	Explanation
Deep Sleep Mode	<p>When this setting is set to On, the printer switches to the deep sleep mode instead of the sleep mode if the printer is not operated or receives no jobs. In deep sleep mode, the Wakeup/Sleep button lights (for AL-M320DN/AL-M310DN) or the Ready light blinks (for AL-M220DN) and more power is saved than when in sleep mode.</p> <p>Note: <i>The printer does not enter the deep sleep mode in the following cases:</i></p> <ul style="list-style-type: none"> - PS3 is selected in Network of Emulation Menu. - MS Network is set to On in Network Menu. - Network Administrator - UPnP - Universal Plug and Play is enabled (default) in EpsonNet Config (web version) <p>The printer recovers from the deep sleep mode in the following cases:</p> <ul style="list-style-type: none"> - When the printer receives a print job - When the Wakeup/Sleep button is pressed (For AL-M320DN/AL-M310DN) - When any button is pressed (for AL-M220DN) <p>Settings (default in bold): On, Off</p>
Power Off If Inactive (Power Off mode)	<p>When this setting is set to On, the printer automatically turns off at the time specified in the Time to Off setting. If EU is selected as Region Setting when the printer is turned on for the first time after you purchase it, the default value is On. If some other region is selected, the default value is set to Off.</p> <p>Note: <i>The printer does not enter the power off mode if it is receiving or sending data.</i></p> <p>The printer recovers from the power off mode when the power switch is turned on.</p> <p>Settings (default in bold): On, Off</p>
Time to Off (Inactive)	<p>Specifies the length of the time until the printer enters the power off mode if there are no button operations and no jobs to be printed.</p> <p>Note: <i>You can adjust the time before power management is applied. Any increase will affect the product's energy efficiency. Please consider the environment before making any change.</i></p> <p>Settings: 120Min, 180Min, 240Min, 360Min, 480Min</p>
Power Off If Disconnect	<p>When these settings are enabled, the printer enters power off mode when it detects that no interfaces have been in use for over 30 minutes.</p> <p>States in which interfaces are unavailable are:</p> <ul style="list-style-type: none"> - When a cable is not connected to the interface - When panel settings do not use interfaces - When the hub and connected computers are off <p>Settings: On, Off</p>

Getting to Know Your Printer

Sleep Schedule Menu

Note:

You need to use *EpsonNet Config* with a web browser to reset the history, because this item is not displayed on the control panel. See the *Network Guide* for the procedure to access *EpsonNet Config* with a web browser.

Item	Explanation
Reset Operate History	Resets the printer's operation history, which is based on the <code>Time to Sleep(Auto)</code> calculation.
Sleep Schedule	<p>Sets a start time and a sleep pattern for up to five time periods through the day. The <code>Sleep Pattern</code> options are as follows:</p> <ul style="list-style-type: none"> <input type="checkbox"/> On: Enters sleep mode according to the <code>Time to Sleep(Auto)</code> or <code>Time to Sleep</code> settings. <input type="checkbox"/> Quick: Enters sleep mode as soon as possible. <p>Note: For an image of these settings, see "Making a weekly sleep schedule" on page 60.</p>
Excluded Day	Specifies a special date on which to apply the sleep pattern for some other day, and specifies the day for up to two days. Each specified date setting is valid once within the each coming specified date.
Sleep Status	Displays the status of the sleep settings for one week starting from the current day. For example, after <code>Time to Sleep(Auto)</code> is set to <code>Enable</code> , you can check if each time-to-sleep value, based on the operation history, has been calculated or is still being prepared.

Reset Menu

Item	Explanation
Clear Warning	Clears warnings except for those that occur from consumable products or mandatory-replacement parts.
Clear All Warnings	Clears all warnings that are shown on the LCD panel or by LED lights.
Reset All	<p>Stops printing and clears the printer memory. The print jobs received from all interfaces are erased. Also resets the life counters for maintenance units A and B.</p> <p>Note: <i>Performing <code>Reset All</code> clears print jobs received from all interfaces. Be careful not to interrupt someone else's job.</i></p>
Reset Maintenance A Counter	<p>Reset the maintenance unit life counter when you replace the maintenance unit. For instructions on replacing the maintenance unit, see the documentation supplied with the maintenance unit.</p> <p>Note: <i>After <code>Performing Reset Maintenance Counter A</code> or <code>Reset Maintenance Counter B</code>, the printer reboots automatically. Be careful not to interrupt someone else's job.</i></p>
Reset Maintenance B Counter	

Getting to Know Your Printer

Printer Settings

Note:

- The settings in the **Printings Menu** are overridden by the settings done in the printer driver from the **Printing Preferences**.
- You can also set items in **Printings Menu** from **Printer Properties > Optional Settings > Printer Settings**.

Tray Menu



Item	Explanation
Paper Size Warning (AL-M320DN/AL-M310DN)	Specifies the trays that need a message to confirm that the paper size in the tray matches the settings on the control panel. This warning message is displayed on the control panel when you load paper in the MP tray and when you close a paper cassette. Settings (default in bold): Off , Cassette , Cassette & MP , MP Tray
Size Warning Timeout (AL-M320DN/AL-M310DN)	Specify the length of the time until the Paper Size Warning message is turned off. Settings (default in bold): 5 sec, 10 sec
MP Tray Size	Specifies the paper size loaded in MP Tray. For the sizes of paper that are available, refer to “Available Paper and Capacities” on page 40 .
MP Tray Type	Specifies the paper type loaded in the MP tray. For the types of paper that are available, refer to “Available Paper and Capacities” on page 40 .
Cassette1 Size	Specifies the paper size loaded in the standard paper cassette. For the sizes of paper that are available, refer to “Available Paper and Capacities” on page 40 .
Cassette1 Type	Specifies the paper type loaded in the standard paper cassette. For the types of paper that are available, refer to “Available Paper and Capacities” on page 40 .
Cassette2 Size/Cassette3 Size (AL-M320DN/AL-M310DN only)	Specifies the paper size loaded in the optional paper cassette. For the sizes of paper that are available, refer to “Available Paper and Capacities” on page 40 .
Cassette2 Type/Cassette3 Type (AL-M320DN/AL-M310DN only)	Specifies the paper type loaded in the optional paper cassette. For the types of paper that are available, refer to “Available Paper and Capacities” on page 40 .
MP Tray AutoSel/Cassette1 AutoSel/Cassette2 AutoSel*/Cassette3 AutoSel* * AL-M320DN/AL-M310DN only	Specifies whether the tray can be selected for printing when Paper Source is selected for Auto Selection in the printer driver. Settings (default in bold): On , Off

Getting to Know Your Printer

Printing Menu

Item	Explanation
Page Size	Specifies the paper size.
	Settings (default in bold): A4 , A5, A6, B5, LT, HLT, LGL, GLT, GLG, EXE, F4, MON, C10, DL, C5, C6, IB5, CTM* * For the sizes of paper that are available for CTM, refer to “Available Paper and Capacities” on page 40 .
Wide A4	Selecting On decreases the left and right margins to 3.4 mm.
	Settings (default in bold): Off , On
Media Type	Specifies the paper type.
	Settings (default in bold): Unspecified , Plain, SemiThk, Preprinted, Letterhead, Recycled, Color, Transparency, Labels, Thick, ExtraThk, SuperThk, Thin, Envelope, Special
Page Side	Specifies 2-sided printing manually. Select Back when printing on the back side of the paper.
	Settings (default in bold): Front , Back
Paper Source	Specifies whether paper feeds into the printer from the MP tray, the standard paper cassette (Cassette 1), or the optional paper cassette unit (Cassette 2/3/4/5). If you select Auto , paper feeds from the paper source containing paper that matches your Paper Size setting.
	Settings (default in bold): Auto , MP Tray, Cassette1, Cassette2*, Cassette3* * For AL-M320DN/AL-M310DN only
Orientation	Specifies whether the page is printed in portrait or landscape orientation.
	Settings (default in bold): Port , Land
Resolution	Specifies the printing resolution.
	Settings (default in bold): 300, 600 , 1200
RITech	Turning on RITech (Resolution Improvement Technology) on produces smoother and crisper lines, text, and graphics.
	Settings (default in bold): On , Off

Getting to Know Your Printer

Item	Explanation
Toner Save	When this setting is selected, the printer saves toner by substituting a gray shade for the black inside of characters. The characters are outlined in full black on the right and lower edges.
	Settings (default in bold): Off , On
Density	Specifies the printing density. The printout becomes darker as the value increases.
	Settings (default in bold): 1, 2, 3 , 4, 5
Emphasize Thin Lines	<p>Adjusts the weight of thin lines so they are printed clearly. The correction results differ depending on the application software.</p> <p>More: Makes thin lines even easier to see (thickens them) than Emphasize, and then prints them</p> <p>Emphasize: Makes thin lines easier to see (thickens them), and then prints</p> <p>Off: Prints without emphasizing thin lines</p>
Top Offset	<p>Makes fine adjustments to the vertical printing position of the page.</p> <p> Important: <i>Make sure that the printed image does not extend beyond the edge of the paper. Otherwise, you may damage the printer.</i></p>
	Settings (default in bold): -99.0 ... 0.0 ... 99.0 mm in 0.5 mm increments
Left Offset	<p>Makes fine adjustments to the horizontal printing position of the page.</p> <p> Important: <i>Make sure that the printed image does not extend beyond the edge of the paper. Otherwise, you may damage the printer.</i></p>
	Settings (default in bold): -99.0 ... 0.0 ... 99.0 mm in 0.5 mm increments
T Offset B	Adjusts the vertical printing position on the back of the paper when printing on both sides. Use this if the printout on the back is not where you expected.
	Settings (default in bold): -99.0 ... 0.0 ... 99.0 mm in 0.5 mm increments
L Offset B	Adjusts the horizontal printing position on the back of the paper when printing on both sides. Use this if the printout on the back is not where you expected.
	Settings (default in bold): -99.0 ... 0.0 ... 99.0 mm in 0.5 mm increments

Getting to Know Your Printer

Item	Explanation
Low Speed Mode	When this mode is selected, the printing speed is slow. The slow printing is expected the following effects: - improves the fixing failure. - lowers the mechanical sounds. - reduces feeding problems of the thick paper.
	Settings (default in bold): Off , On

Emulation Menu

Item	Explanation
USB/Network	Specifies emulation mode for each interface.
	Settings (default in bold): Auto , ESCP2, FX, I239X, PS3, PCL

PCL Menu

Item	Explanation
FontSource	Sets the default font source.
	Settings (default in bold): Resident , Download* * Available only when downloaded fonts are available.
Font Number	Sets the default font number for the default font source. The available number depends on the settings you made.
	Settings (default in bold): 0 ... 65535 (depending on your settings)
Pitch	Specifies the default font pitch if the font is scalable and of fixed-pitch. This item may not appear depending on the FontSource or Font Number settings.
	Settings (default in bold): 0.44 ... 10.00 ... 99.99 cpi in 0.01 cpi increment
Height	Specifies the default font height if the font is scalable and proportional. This item may not appear depending on the FontSource or Font Number settings.
	Settings (default in bold): 4.00 ... 12.00 ... 999.75 pt in 0.25 pt increment

Getting to Know Your Printer

Item	Explanation
SymSet	Selects the default symbol set. If the font you selected in FontSource and Font Number is not available in the new SymSet setting, the FontSource and the Font Number settings are automatically replaced with the default value, IBM-US.
	Settings (default in bold): IBM-US , Roman-8, Roman-9, ECM94-1, 8859-2 ISO, 8859-9 ISO, 8859-10 ISO, 8859-15 ISO, PcBlit775, IBM-DN, PcMultiling, PcE.Europe, PcTk437, PcEur858, Pc1004, WiAnsi, WiE.Europe, WiTurkish, WiBALT, DeskTop, PsText, VeInternati, VeUS, MsPublishin, Math-8, PsMath, VeMath, PiFont, Legal, UK, ANSI ASCII, Swedis2, Italian, Spanish, German, Norweg1, French2, Windows, McText, Hebrew7, 8859-8 ISO, Hebrew8, Arabic8, OCR A, OCR B, Pc866Cyr, Pc866Ukr, WinCyr, ISOCyr, Pc8Grk, Pc851Grk, WinGrk, ISOGrk, Greek8, Pc862Heb, Pc864Ara, HPWARA
Form	Selects the number of lines for the selected paper size and orientation. This also causes a line spacing (VMI) change, and the new VMI value is stored in the printer. This means that later changes in the Page Size or Orientation settings cause changes in the Form value, based on the stored VMI.
	Settings (default in bold): 5 ... 64 ... 128Lines
CR Function	These functions are included for users of particular operating systems, such as UNIX.
	Settings (default in bold): CR , CR+LF
LF Function	These functions are included for users of particular operating systems, such as UNIX.
	Settings (default in bold): LF , CR+LF
Tray Assign	Changes the assignment for the paper source select command. When 4 is selected, the commands are set as compatible with the HP LaserJet 4. When 4K is selected, the commands are set as compatible with the HP LaserJet 4000, 5000, and 8000. When 5S is selected, the commands are set as compatible with the HP LaserJet 5S.
	Settings (default in bold): 4K , 5S, 4

PS3 Menu

Item	Explanation
Error Sheet	When you select On , the printer prints out an error sheet when an error occurs in the PS3 mode or when the PDF file you tried to print is not a supported version.
	Settings (default in bold): Off , On

Getting to Know Your Printer

Item	Explanation
Binary	Specifies the data format. Select On for the Binary data and select Off for the ASCII data. Note: <i>Binary can only be used with network connection. To use the Binary data, make sure your application supports Binary data and that SEND CTRL-D Before Each Job and SEND CTRL-D After Each Job are set to No. When this setting is set to On, you cannot use TBCP (Tagged binary communication protocol) in the printer driver settings.</i>
	Settings (default in bold): Off, On
PDF Page Size	Specifies the paper size when you send the PDF file directory from a computer or some other device. If Auto is selected, the paper size is determined based on the size of the first page that is printed.
	Settings (default in bold): Auto, A4, A5, A6, B5, LT, HLT, LGL, GLT, GLG, EXE, F4, MON, C10, DL, C5, C6, IB5

ESCP2 Menu

Item	Explanation
Font	Selects the font.
	Settings (default in bold): Courier, Prestige, Roman, Sans serif, Roman T, Orator S, Sans H, Script, OCR A, OCR B
Pitch	Selects the pitch (the horizontal spacing) of the font in fixed pitch, measured in cpi (characters per inch). You can also choose proportional spacing.
	Settings (default in bold): 10cpi, 12cpi, 15cpi, Prop.
Condensed	Turns condensed printing on or off.
	Settings (default in bold): Off, On
T.Margin	Sets the distance from the top of the page to the baseline of the first printable line. The distance is measured in inches. The smaller the value, the closer the printable line is to the top.
	Settings (default in bold): 0.40 ... 0.50 ... 1.50 inch in 0.05-inch increments
Text	Sets the page length in lines. For this option, a line is assumed to be 1 pica (1/6 inch). If you change the Orientation, Page Size, or T.Margin settings, the page length setting automatically returns to the default for each paper size.
	Settings (default in bold): 1 ... 66 Lines

Getting to Know Your Printer

Item	Explanation
CGTable	Use the character generator (CG) table option to select the graphics character table or the italics table. The graphics table contains graphic characters for printing lines, corners, shaded areas, international characters, Greek characters, and mathematical symbols. If you select <i>Italic</i> , the upper half of the character table is defined as italic characters.
	Settings (default in bold): PcUSA , Italic, PcMultilin, PcPortugue, PcCanFrenc, PcNordic, PcTurkish2, Pclcelandic, PcE.Europe, BpBRASCI, BpAbicomp, Roman-8, PcEur858, ISO Latin1, 8859-15 ISO, PcSI437, PcTurkish1, 8859-9 ISO, Mazowia, CodeMJK, PcGk437, PcGk851, PcGk869, 8859-7 ISO, PcCy855, PcCy866, PcUkr866, PcLit771, Bulgarian, Hebrew7, Hebrew8, PcHe862, PcAr864, PcAr864Ara, PcAr720, PcLit774, Estonia, ISO Latin2, PcLat866
Country	Use this option to select one of the fifteen international symbol sets. See the <i>Font Guide</i> for samples of the characters in each country's symbol set.
	Settings (default in bold): USA , France, Germany, UK, Denmark, Sweden, Italy, Spain1, Japan, Norway, Denmark2, Spain2, LatinAmeric, Korea, Legal
Auto CR	Specifies whether the printer performs a carriage-return/line-feed (CR-LF) operation whenever the printing position goes beyond the right margin. If you select <i>Off</i> , the printer does not print any characters beyond the right margin and does not perform any line wrapping until it receives carriage-return character. This function is handled automatically by most applications.
	Settings (default in bold): On , Off
Auto LF	If you select <i>Off</i> , the printer does not send an automatic line-feed (LF) command with each carriage-return (CR). If <i>On</i> is selected, a line-feed command is sent with each carriage-return. Select <i>On</i> if your text lines overlap.
	Settings (default in bold): Off , On
Bit Image	The printer is able to emulate the graphics densities set with the printer commands. If you select <i>Dark</i> , the bit image density is high, and if you select <i>Light</i> , the bit image density is low.
	If you select <i>BarCode</i> , the printer converts bit images to bar codes by automatically filling in any vertical gaps between dots. This produces unbroken vertical lines that can be read by a bar code reader. This mode will reduce the size of the image being printed, and may also cause some distortion when printing bit image graphics.
ZeroChar	Specifies whether the printer prints a slashed or unslashed zero.
	Settings (default in bold): 0 , (or the zero character with a slash)

Getting to Know Your Printer

FX Menu

Item	Explanation
Font	Selects the font.
	Settings (default in bold): Courier , Prestige, Roman, Sans serif, Script, Orator S, OCR A, OCR B
Pitch	Selects the pitch (the horizontal spacing) of the font in fixed pitch, measured in cpi (characters per inch). You can also choose proportional spacing.
	Settings (default in bold): 10cpi , 12cpi, 15cpi, Prop.
Condensed	Turns condensed printing on or off.
	Settings (default in bold): Off , On
T.Margin	Sets the distance from the top of the page to the baseline of the first printable line. The distance is measured in inches. The smaller the value, the closer the printable line is to the top.
	Settings (default in bold): 0.40 ... 0.50 ... 1.50 inch in 0.05-inch increments
Text	Sets the page length in lines. For this option, a line is assumed to be 1 pica (1/6 inch). If you change the Orientation, Page Size, or T.Margin settings, the page length setting automatically returns to the default for each paper size.
	Settings (default in bold): 1 ... 66 Lines
CGTable	Use the character generator (CG) table option to select the graphics character table or the italics table. The graphics table contains graphic characters for printing lines, corners, shaded areas, international characters, Greek characters, and mathematical symbols. If you select <i>Italic</i> , the upper half of the character table is defined as italic characters.
	Settings (default in bold): PcUSA , Italic, PcMultilin, PcPortugue, PcCanFrenc, PcNordic, PcTurkish2, Pclcelandic, PcE.Europe, BpBRASCI, BpAbicomp, Roman-8, PcEur858, ISO Latin1, 8859-15 ISO
Country	Use this option to select one of the fifteen international symbol sets. See the <i>Font Guide</i> for samples of the characters in each country's symbol set.
	Settings (default in bold): USA , France, Germany, UK, Denmark, Sweden, Italy, Spain1, Japan, Norway, Denmark2, Spain2, LatinAmeric
Auto CR	Specifies whether the printer performs a carriage-return/line-feed (CR-LF) operation whenever the printing position goes beyond the right margin. If you select Off , the printer does not print any characters beyond the right margin and does not perform any line wrapping until it receives a carriage-return character. This function is handled automatically by most applications.
	Settings (default in bold): On , Off

Getting to Know Your Printer

Item	Explanation
Auto LF	If you select Off , the printer does not send an automatic line-feed (LF) command with each carriage-return (CR). If On is selected, a line-feed command is sent with each carriage-return. Select On if your text lines overlap.
	Settings (default in bold): Off, On
Bit Image	The printer is able to emulate the graphics densities set with the printer commands. If you select Dark , the bit image density is high, and if you select Light , the bit image density is low. If you select BarCode , the printer converts bit images to bar codes by automatically filling in any vertical gaps between dots. This produces unbroken vertical lines that can be read by a bar code reader. This mode will reduce the size of the image being printed, and may also cause some distortion when printing bit image graphics.
	Settings (default in bold): Dark, Light, BarCode
ZeroChar	Specifies whether the printer prints a slashed or unslashed zero.
	Settings (default in bold): 0 , (or the zero character with a slash)

I239X Menu

Item	Explanation
Font	Selects the font.
	Settings (default in bold): Courier, Prestige, Gothic, Orator, Script, Presentor, Sans serif
Pitch	Selects the pitch (the horizontal spacing) of the font in fixed pitch, measured in cpi (characters per inch). You can also choose proportional spacing.
	Settings (default in bold): 10cpi, 12cpi, 15cpi, 17cpi, 20cpi, 24cpi, Prop.
Code Page	Selects the character tables. Character tables contain the characters and symbols used by different languages. The printer prints text based on the selected character table.
	Settings (default in bold): 437, 850, 858, 860, 863, 865
T.Margin	Sets the distance from the top of the page to the baseline of the first printable line. The distance is measured in inches. The smaller the value, the closer the printable line is to the top.
	Settings (default in bold): 0.30 ... 0.40 ... 1.50 inch in 0.05-inch increments

Getting to Know Your Printer

Item	Explanation
Text	Sets the page length in lines. For this option, a line is assumed to be 1 pica (1/6 inch). If you change the <code>Orientation</code> , <code>Page Size</code> , or <code>T.Margin</code> settings, the page length setting automatically returns to the default for each paper size.
	Settings (default in bold): 1 ... 67 Lines
Auto CR	Specifies whether the printer performs a carriage-return/line-feed (CR-LF) operation whenever the printing position goes beyond the right margin. If you select <code>Off</code> , the printer does not print any characters beyond the right margin and does not perform any line wrapping until it receives a carriage-return character. This function is handled automatically by most applications.
	Settings (default in bold): Off , On
Auto LF	If you select <code>Off</code> , the printer does not send an automatic line-feed (LF) command with each carriage-return (CR). If <code>On</code> is selected, a line-feed command is sent with each carriage-return. Select <code>On</code> if your text lines overlap.
	Settings (default in bold): Off , On
Alt. Graphics	Turns the Alternate Graphics option on or off.
	Settings (default in bold): Off , On
Bit Image	The printer is able to emulate the graphics densities set with the printer commands. If you select <code>Dark</code> , the bit image density is high, and if you select <code>Light</code> , the bit image density is low.
	Settings (default in bold): Dark , Light
ZeroChar	Specifies whether the printer prints a slashed or unslashed zero.
	Settings (default in bold): 0 , (or the zero character with a slash)
CharacterSet	Selects character table 1 or 2.
	Settings (default in bold): 1, 2

Getting to Know Your Printer

Admin Settings

Note:

- ❑ To set a password using EpsonNet Config with a web browser, access **Network Administrator > Administrator > Password**.
- ❑ Enter the administrator password to access the Admin Settings menu for AL-M320DN/AL-M310DN.
- ❑ The password is not set in default. For AL-M320DN/AL-M310DN press the **OK** button to proceed when the Admin Password is required.
- ❑ If you forget your password, contact your dealer. Note that when the password is initialized, the settings and data stored on the printer are deleted. Depending on your environment, settings, such as network connection settings, may need to be done again. We recommend making a note or backup of the necessary data and setting information.

Password Config Menu

Item	Explanation
Change Password	Specifies an administrator password. Enter the old password first and then enter the new password twice. To enter the password on the AL-M320DN/AL-M310DN' LCD panel, press the ▲ Up or ▼ Down buttons to select the characters and press the ► Right button to confirm. After all characters are determined, press the OK button.
	Settings : (up to 20 characters) Note: The following characters and blank spaces can be used. 0123456789abcdefghijklmnopqrstuvwxyzABCDEFGHIJKLMNOPQRSTUVWXYZ !"#\$%&'()*+,-./:;<=>?@^_`{ }~
Limitation	When Interface is selected, you need to enter the password to change interface settings. When Config is selected, you need to enter the password to change the items you configured. Note: The settings for this item cannot be changed using EpsonNet Config with a web browser.
	Settings (default in bold): Disable , Interface, Config, All

Init SelectType

Item	Explanation
Init All SelectType	For AL-M320DN/AL-M310DN, if Yes (Unprinted data is deleted) is selected, all control panel settings are changed to their factory settings. Note: To do this from EpsonNet Config with a web browser, access Network Administrator > Administrator > Default Settings .

Getting to Know Your Printer

Bookmark Menu (For AL-M320DN/AL-M310DN)

The bookmark menu appears by pressing the **OK** button while the LCD panel displays *Ready*.

In the bookmark menu, the bookmarked setting items are listed and you can select one of them. The following menus are bookmarked by default.

- Reset Menu
- MP Tray Size
- System Information

To replace a bookmarked menu to another menu, display the menu you want to add and press the **OK** button for more than two seconds.

Note:

The maximum number of menus you can register as bookmarks is 3.

Loading Paper

Loading Paper

Available Paper and Capacities

Since the quality of any particular brand or type of paper may be changed by the manufacturer at any time, Epson cannot guarantee the quality of any type of paper. Always test samples of paper stock before purchasing large quantities or printing large jobs.

Paper type	Paper size	Loading capacity or paper height			Duplex (Auto)
		MP tray	Paper cassette 1	Paper cassette 2*1/3*1	
Plain Recycled Preprinted Special	A4, A5 Portrait* ² , B5, Letter (LT), Half Letter (HLT)* ² , Legal (LGL)* ³ , Government Letter (GLT), Government Lagal (GLG)* ³ , Executive (EXE), F4* ³	100 sheets	250 sheets	250 sheets	✓
	A5 Landscape, A6	100 sheets	250 sheets	250 sheets	-
	Custom (CTM) or User Defined Size				
	Width : 70 - 216 mm Length* ⁴ : 148 - 365 mm	16.5 mm	-	-	-
	Width : 105 - 216 mm Length* ⁴ : 148 - 365 mm	-	27.5 mm	27.5 mm	-
Semi-thick Color Letterhead Special	A4, A5 Portrait* ² , B5, Letter (LT), Half Letter (HLT)* ² , Legal (LGL), Government Letter (GLT), Government Lagal (GLG), Executive (EXE), F4	16.5 mm	27.5 mm	27.5 mm	✓
	A5 Landscape, A6	16.5 mm	27.5 mm	27.5 mm	-
	Custom (CTM) or User Defined Size				
	Width : 70 - 216 mm Length* ⁴ : 148 - 365 mm	5 sheets	-	-	-
	Width : 105 - 216 mm Length* ⁴ : 148 - 365 mm	-	27.5 mm	27.5 mm	-

Loading Paper

Paper type	Paper size	Loading capacity or paper height			Duplex (Auto)
		MP tray	Paper cassette 1	Paper cassette 2*1/3*1	
Thick Extra-Thick Special	A4, A5 Portrait* ² , B5, Letter (LT), Half Letter (HLT)* ² , Legal (LGL), Government Letter (GLT), Government Lagal (GLG), Executive (EXE), F4	5 sheets	5 sheets	5 sheets	✓
	A5 Landscape, A6	5 sheets	5 sheets	5 sheets	-
	Custom (CTM) or User Defined Size				
	Width : 70 - 216 mm Length* ⁴ : 148 - 365 mm	5 sheets	-	-	-
Width : 105 - 216 mm Length* ⁴ : 148 - 365 mm	-	5 sheets	5 sheets	-	
Super-Thick Special	A4, A5 Portrait* ² , B5, Letter (LT), Half Letter (HLT)* ² , Legal (LGL), Government Letter (GLT), Government Lagal (GLG), Executive (EXE), F4	5 sheets	-	-	-
	A5 Landscape, A6	5 sheets	-	-	-
Envelopes	C5, C6, C10, DL, Monarch (Mon)	5 sheets	-	-	-
Transparencies	A4, Letter (LT)	1 sheets	-	-	-
Labels	A4, Letter (LT)	1 sheets	-	-	-

*1 AL-M320DN/AL-M310DN only

*2 2-sided printing cannot be done if the grain of the paper is perpendicular to the direction of the paper feed.

*3 Support the trailing edge of the paper with your hands when loading.

*4 For paper longer than 297 mm, support the trailing edge of the paper with your hands when loading.

Note:

- ❑ Even paper with a thickness within range may not be able to feed due to the paper's characteristics and qualities (e.g.: direction of the grain, stiffness). It may also have an effect on the print results.
- ❑ If you select Auto Select in Paper Source in the printer driver, the printer will search for a paper source containing the paper size specified in Document Size, and prints from the paper source until there is no more paper, then it prints from the next paper source automatically. Using this auto select function, for plain paper (80 g/m²), the printer can continuously print up to 850 sheets (for AL-M320DN/AL-M310DN), or up to 350 sheets (for AL-M220DN).
- ❑ The output tray capacity for plain paper (80 g/m²) is up to 250 sheets (standard output tray)
- ❑ In continuous printing, such as when printing on paper with a smaller width than A4, the print speed may slow down when printing several pages, depending on the circumstances, due to the printer's temperature adjustments.
- ❑ When printing on damp paper in a low-temperature environment, moisture on the paper is vaporized by the heat when the toner is fixed, which may be seen as water vapor when the paper is ejected. Increasing the room temperature makes this disappear.

Loading Paper

Available paper types and weights

Paper type	Paper weight	Remarks
Plain	60 - 90 g/m ²	<ul style="list-style-type: none"> ❑ For the paper less than 64 g/m², set the paper type to Thin on the control panel or EpsonNet Config with a web browser, and in the printer driver. See "Using the Control Panel" on page 17 for how to access the control panel. ❑ For paper over 65 to 74 g/m², Set 001 Plain to 1 in the Printer Adjust Menu. For details, see "Printer Adjust Menu" on page 106. ❑ Use only at normal temperature (15 - 25°C) and humidity (40 - 60%). Poor quality paper may reduce print quality, or cause paper jams and other problems.
Recycled	60 - 90 g/m ²	
Semi-thick	75 - 90 g/m ²	-
Color	91 - 105 g/m ²	-
Letterhead	91 - 105 g/m ²	-
Preprinted	60 - 90 g/m ²	-
Thick	106 - 135 g/m ²	Thick
	136 - 163 g/m ²	Extra-Thick
	164 - 216 g/m ²	Super-Thick
Custom	60 - 216 g/m ²	MP tray only
	60 - 163 g/m ²	Paper cassette1/2/3 (for AL-M320DN/AL-M310DN) Paper cassette1 (for AL-M220DN)

Loading Paper

**Important:**

You cannot use the following paper in this printer. It may cause printer damage, paper jams, and poor print quality:

- Media meant for other black-and-white laser printers, color laser printers, color copiers, black-and-white copiers, or ink jet printers*
- Previously printed paper by any other black-and-white laser printers, color laser printers, color copiers, black-and-white copiers, ink jet printers, or thermal transfer printers*
- Very thin paper (59 g/m² or less), or very thick paper (221 g/m² or more)*
- Carbon paper, carbonless paper, thermal-sensitive paper, pressure-sensitive paper, acid paper, or paper that uses high-temperature-sensitive ink (around 160°C)*
- Labels that peel easily or labels that do not cover the backing sheet completely*
- Special surface-coated paper or special surface-colored paper*
- Paper that has binder holes or is perforated*
- Paper that has glue, staples, paper clips, or tape on it*
- Paper that attracts static electricity*
- Moist or damp paper*
- Paper of uneven thickness*
- Overly thick or thin paper*
- Paper that is too smooth or too rough*
- Paper that is different on the front and back*
- Paper that is folded, curled, wavy, or torn*
- Paper of irregular shape, or paper that does not have right angle corners*
- Paper for which the grain is perpendicular to the direction of the paper feed*

Loading Paper

Loading Paper

Paper cassette

Perform the same procedure to load paper into the optional paper cassette.

Note:

For AL-M320DN/AL-M310DN, a warning message appears if the cassette that is higher than the cassette from which the printer is fed (if feeding from C3, then C2 and C1) is not inserted. You can print.

If you do not want this message to appear, set the operation panel's **Common Settings > Setup Menu > Cassette Warning to Off**.

["Setup Menu" on page 21](#)

- 1** Pull out the paper cassette.

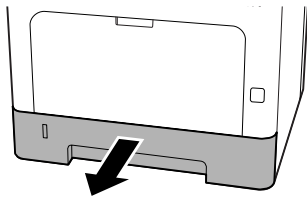

- 2** If the paper lifting plate inside the cassette is raised, press down on the center of the paper lifting plate until the locking tab is locked.

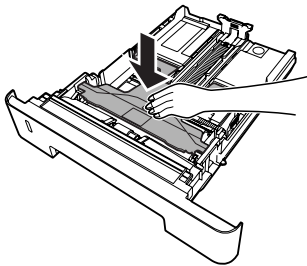

- 3** Pinch the knobs and slide the paper guides to accommodate the paper you are loading.

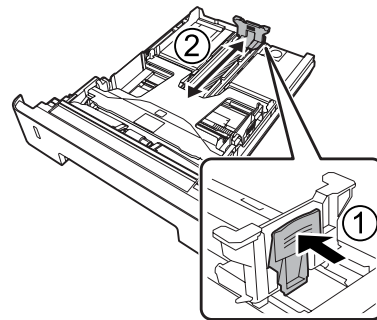

Note:

For paper larger than A4, press down the button on the bottom edge of the cassette, pull out the cassette, and then load the paper.

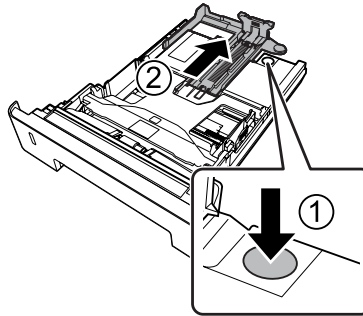

- 4** Grip the paper guides and pull them out sideways to align them with the appropriate position for the paper you are loading.

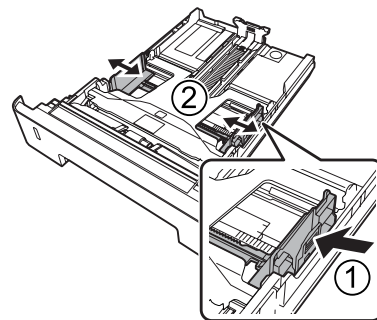

Note:

Be sure to adjust the paper guides according to the size of the paper you loaded, to prevent paper feed failures, paper jams or other errors.

Loading Paper

- 5** Load a stack of the desired paper on the center of the paper cassette with the printable surface facing down.

Note:

- ❑ Make sure that you do not load paper beyond the limit mark. See [“Available Paper and Capacities” on page 40](#).
- ❑ Do not move the paper guide after the paper is loaded; if you do, the paper may not be able to feed correctly.

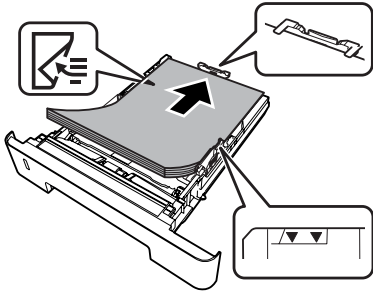

- 6** Push the paper cassette into the printer.

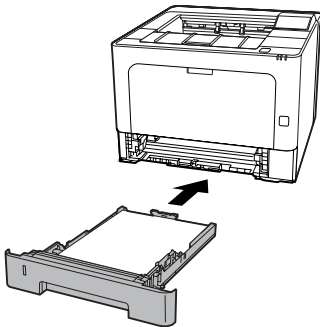

- 7** Extend the paper support according to the size of the paper to prevent the paper from slipping off the printer.

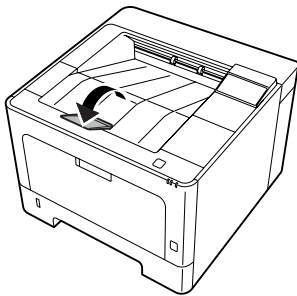

- 8** Set the paper size on the paper size setting dial (or Cassette Size on the control panel) and Cassette Type settings to match the loaded paper size and paper type on the control panel. For details, see [“Tray Menu” on page 28](#).

MP tray

Note:

To load envelopes, see [“Envelopes” on page 46](#).

- 1** Open the MP tray.

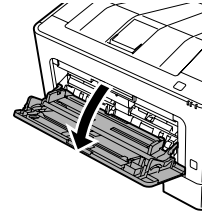

- 2** Extend the paper support of the MP tray.

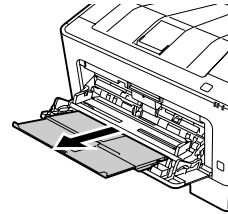

- 3** Slide the paper guides to accommodate the paper you are loading.

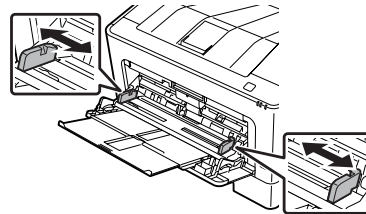

Note:

Be sure to adjust the paper guides according to the size of the paper you loaded to prevent paper feed failures, paper jams or any other errors.

- 4** Load a stack of the desired paper with the printable surface facing up.

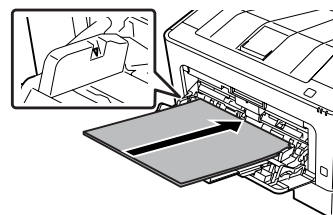

Loading Paper

Note:

Make sure that you do not load paper beyond the maximum limit guide. See “Available Paper and Capacities” on page 40.

- 5** Extend the paper support according to the size of the paper to prevent the paper from slipping off the printer.

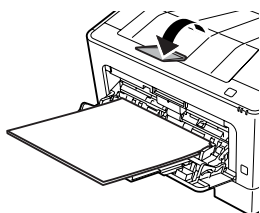

Note:

To eject paper to the optional face-up tray, see “Paper Output Settings” on page 46.

- 6** Set the MP Type setting on the control panel to match the type of paper loaded. For details, see “Tray Menu” on page 28.

Paper Output Settings

Orientation to eject paper

If the paper is A5, the printer can print on it in either orientation (landscape or portrait).

- 1** Set the paper size (portrait or landscape) using the Tray Menu according to the table below.

1) Paper in the tray	2) Tray Menu
A5 portrait	A5 Portrait
A5 landscape*	A5 Landscape

* Standard orientation

- 2** Access the printer driver's Main tab, click Paper Output Settings, and select a radiobutton for the output orientation.

Selecting and Using Print Media

You can use special media, such as envelopes, thick paper, labels, and transparencies.

When loading special media, you should make paper settings. You can also do these settings in the Tray Menu in the control panel (for AL-M320DN/AL-M310DN), in EpsonNet Config on your web browser, or in Printer Settings in the printer driver (for AL-M220DN). See “Tray Menu” on page 28 and “How to access the control panel menus (AL-M320DN/AL-M310DN)” on page 17.

Note:

Since the quality of any particular brand or type of media may be changed by the manufacturer at any time, Epson cannot guarantee the quality of any type of media. Always test samples of media stock before purchasing large quantities or printing large jobs.

Envelopes

Available envelopes

- Envelopes that have no glue or no tape



Important:

Do not use window envelopes. The plastic on most window envelopes will melt.

Available paper source

- MP tray

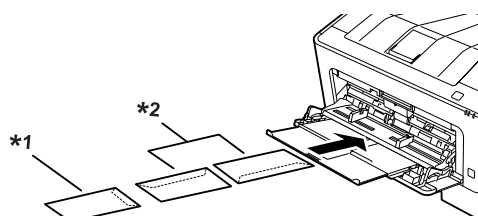

*1 C5, IB5

*2 MON, C10, DL, C6

Loading Paper

Printer driver settings

Make the following settings according to the envelopes you loaded on the printer.

	Printer driver settings
Paper Size	Refer to “Available Paper and Capacities” on page 40.
Paper Source	MP Tray
Paper Type	Envelope

Note:

- Depending on the quality of envelopes, the printing environment, or the printing procedure, envelopes might be wrinkled. Make a trial print run before you print on a lot of envelopes.
- Duplex printing is not available for envelopes.
- If you do not load envelopes in the MP tray right after they have been removed from the packaging, they may bulge. To avoid jams, flatten them as shown below before loading them in the MP tray.

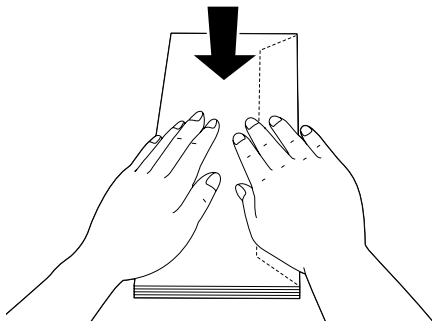

- If envelopes do not feed well, reducing the number of envelopes that are loaded may solve the problem.

Other paper

You can use super-thick paper, labels, and transparencies. See [“Available Paper and Capacities” on page 40.](#)

Available paper source

- MP tray
For loading paper, see [“MP tray” on page 45.](#)

Printer driver settings

Make the following settings according to the paper you loaded on the printer. See [“Available Paper and Capacities” on page 40.](#)

	Printer driver settings
Paper Size	Refer to “Available Paper and Capacities” on page 40.
Paper Source	MP Tray
Paper Type	Refer to “Available Paper and Capacities” on page 40.

Available labels

- Labels designed for laser printers or plain-paper copiers
- Labels that completely cover the backing sheet, with no gaps between the individual labels

Note:

- Depending on the quality of labels, the printing environment, or the printing procedure, labels might be wrinkled. Make a trial print run before you print on a lot of labels.
- Duplex printing is not available for labels.
- Press a sheet of paper on top of each sheet of labels. If the paper sticks, do not use those labels in your printer.

Custom paper size

Available paper source

- MP tray
- Paper cassettes

Printer driver settings

Make the following settings according to the envelopes you loaded on the printer.

	Printer driver settings
Paper Size	User Defined Size* * For available sizes, refer to “Available Paper and Capacities” on page 40.

Loading Paper

Printer driver settings	
Paper Source	MP Tray, Cassette 1, Cassette 2*, Cassette 3* *For AL-M320DN/AL-M310DN only
Paper Type	Refer to "Available Paper and Capacities" on page 40.

Note:

- ❑ Depending on the quality of the non-standard size paper, the printing environment, or the printing procedure, the paper might skew. Make a trial print run before you print on a lot of non-standard size paper.
- ❑ For Windows, access the printer driver, then select **User Defined Size** from the Document Size list on the Main tab. In the User Defined Paper Size dialog box, adjust the Paper Width, Paper Height, and Unit settings to match your custom paper. Then click **OK** and your custom paper size will be saved.
- ❑ When sharing the printer on a network, you cannot create User Defined Size at the client.
- ❑ If you cannot use the printer driver as explained above, access the control panel (for AL-M320DN/AL-M310DN), or EpsonNet Config from your web browser, select Printer Settings > Printing Menu, and set Page Size to CTM (custom).

Printing Tasks

Basics of Printing

This section describes the basics of printing using the Windows printer driver (**ESC/Page** language) as an example. Printing can also be done by similar procedures using other supported operating systems or emulation languages.

1

Load a stack of paper.

For available paper, see [“Available Paper and Capacities” on page 40](#).

For how to load paper in the paper source, see [“Loading Paper” on page 44](#).

2

Make the appropriate settings in the control panel (for AL-M320DN/AL-M310DN), in Printer Settings in the printer driver (for AL-M220DN), or in **EpsonNet Config** on your web browser.

The items to be set are different depending on the paper you use.

See [“Using the Control Panel” on page 17](#).

See [“Selecting and Using Print Media” on page 46](#).

3

Click **Print** from the File menu on the application you are using.

4

Select your printer.

5

Click **Properties** or **Printing Preferences**. The printer driver's Main screen appears.

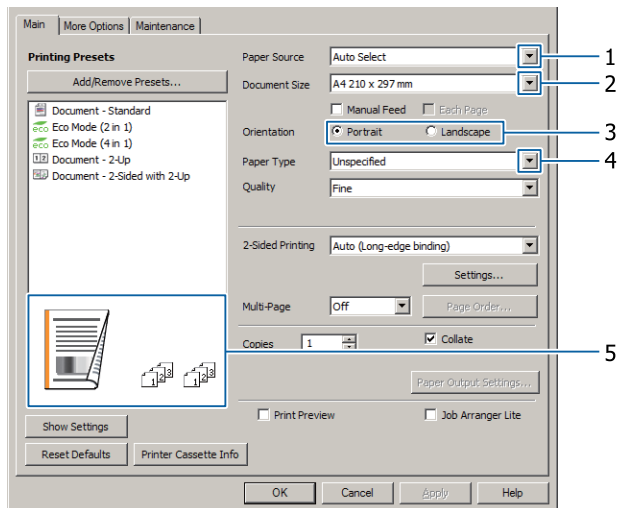

6

Make the settings in the table below:

Item		Explanation
1	Paper Source	Selects the paper source in which the paper to be printed is loaded.
2	Document Size	Selects the size of paper you set in applications.
3	Orientation	Selects the orientation you set in applications.

Printing Tasks

Item		Explanation
4	Paper Type	Selects the type of print media loaded in the paper source.
5	(printout image)	Displays an image of the printout.

Note:

- To show the help for each item, right-click the item and click **Help** on the printer driver.
- In the Main screen, you can also make settings for 2-sided printing and collating.
- In the More Options screen, you can make settings for reducing/enlarging the document or watermark feature. See “Setting Advanced Features” on page 54.

7 Click **OK** to close the printer driver screen.

8 Click **Print** to start printing.

Setting the Main Screen

This screen enables basic settings for printing such as paper source or paper size, and also enables the settings for the basic functions such as multi-page printing or 2-sided printing.

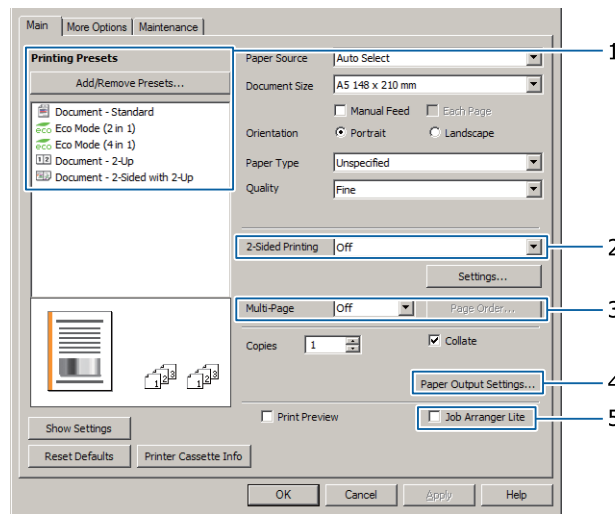

Note:
The printer driver’s online help provides explanations on printer driver settings.

Item		Explanation
1	Printing Presets	The settings, such as Document - 2-Up, or Document - 2-Sided, are preset. You can register the print settings you desire to the list.

Printing Tasks

Item		Explanation
2	2-Sided Printing	Prints on the front and back of the sheet. Combined with the Reduce/Enlarge function, a 2 page A3 document can be printed on one A4 size sheet. Click Settings to make Binding Edge, Binding Margin and folded booklet settings. See "Printing a booklet" on page 54.
3	Multi-Page	<input type="checkbox"/> Multi-Page: Enables 2 pages or 4 pages per sheet printing on the same paper size as the original document. 2-Sided Printing can be combined with this function. <input type="checkbox"/> Poster: For example, you can make large, about A2 size, printouts by printing data for A4 size on four A4 sheets and stick them together. See "Printing data for a single page across multiple sheets (poster printing)" on page 55.
4	Paper Output Settings	Selects the paper output orientation for the paper sizes which are supported to be fed in both portrait and landscape orientations. See "Paper Output Settings" on page 46.
5	Job Arranger Lite	Allows you to print several documents created by different applications at one time by arrange settings. See "Printing multiple print jobs at one time" on page 54.

Setting the More Options Screen

This screen enables settings, such as for secure printing, reduced, enlarged, or printing with an overlay.

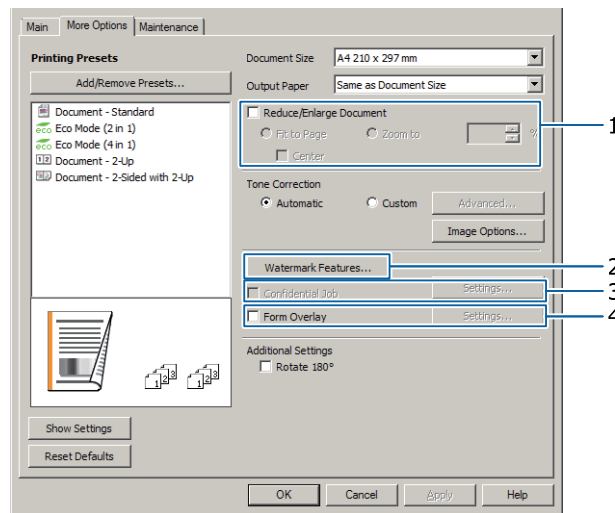

Item		Explanation
1	Reduce/Enlarge Document	This function allows you to reduce or enlarge the image to be printed. 2-Sided Printing can be combined with this function.

Printing Tasks

Item		Explanation
2	Watermark Features	<p>Anti-Copy Pattern</p> <p>This function allows you to print a document as a copy-protected document. When you try to copy a copy-protected document, "Copy" is printed several times on the document. This function is useful to prevent unauthorized copying. Any text string can be registered.</p> <p>Note:</p> <ul style="list-style-type: none"> <input type="checkbox"/> <i>Epson does not guarantee protection from information leakage or any other damages caused by using this function. Hidden letters may appear in some cases.</i> <input type="checkbox"/> <i>Screen-tone may be too dark, hidden letters may not be printed on the entire image, or hidden letters may not appear when photocopied. This depends on the models, settings, and combinations of photocopiers, fax machine, input devices such as digital cameras and scanners, output devices such as printers; printer driver settings of this product; condition of consumables, such as toner and output paper type.</i> <hr/> <p>Watermark</p> <p>This function allows you to print a text-based or image-based watermark on your document.</p> <p>Note:</p> <p><i>You can register up to 10 original watermarks.</i></p> <hr/> <p>Header/Footer</p> <p>This function allows you to print user name, computer name, date, time, document name, or collate number, at the top or bottom of each page in a document.</p>
3	Confidential Job (AL-M320DN/AL-M310DN only)	<p>This function allows you to apply a password to the print job. You can print the job by entering the password on the printer's control panel. See the "Using the Reserve Job function (AL-M320DN/AL-M310DN)" on page 57.</p>
4	Form Overlay	<p>This function allows you to print a standard form or letterhead onto original documents. See "Printing with an overlay" on page 58.</p>

Printing Tasks

Setting the Maintenance Screen

This screen enables you to start Job Arranger Lite, enables settings, such as Notice Settings for EPSON Status Monitor. For details, see the help for each item.

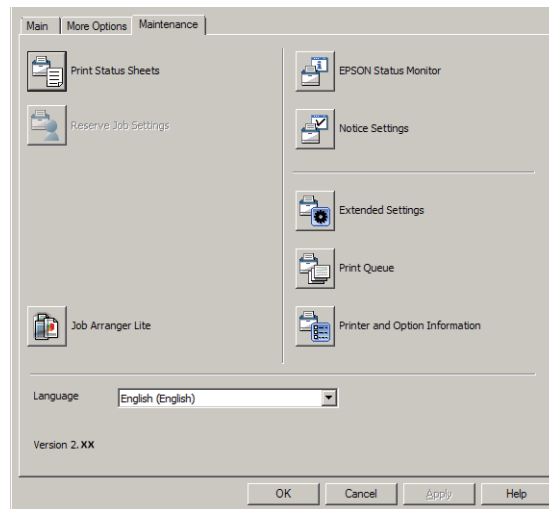

For AL-M220DN users

You can do Printer Adjust Menu settings on the printer's control panel from this screen. See [“Printer Adjust Menu” on page 106](#) for how to access the menu.

Printing Tasks

Setting Advanced Features

The printer driver has useful functions such as 2-sided printing or multi-page printing to save paper and toner, or adding an anti-copy pattern to prevent unauthorized copying.

The explanations in this section use the standard ESC/Page printer driver on Windows as an example.

Note:

- There are features that are not supported by the printer driver on other emulation language or operating systems.
- These features may not be applied with other settings (such as paper type).

Printing multiple print jobs at one time

This function allows you to print several documents created by different applications at one time by arranging settings, such as the printing order, duplexing, and the print layout.

- 1 Click the **Main** tab.
- 2 Select the **Job Arranger Lite** check box.
- 3 Click **OK**.

The Print Job Arranger screen appears when a print job is executed. Make appropriate settings. For details, see the Print Job Arranger help.

Printing a booklet

This function allows you to arrange pages to be a booklet. Two pages are printed on both sides of the paper that is the same size as the print data.

Combined with Reduce/Enlarge Document printing, the output paper size can be changed.

Set paper that is suitable for 2-sided printing (duplex printing). See “Available Paper and Capacities” on page 40.

Printing to fold a batch of pages in half

This function prints a booklet ready for center binding. Fold the entire document in half, and then bind it at the center of the printout. This setting is suitable for documents that have only a few pages.

For example, eight pages of an A4 size document are printed on two sheets. Folding the pages in half by overlapping all the sheets makes an A5 size booklet of eight pages.

- 1 Select **Auto (Long-edge binding)** or **Auto (Short-edge binding)** in the 2-sided Printing list box and click **Settings**.

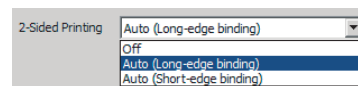

- 2 Select the **Booklet** check box and select **Center Binding**.
- 3 Click **OK** to close setting dialog box.
- 4 Print the document, fold all sheets in half, and then bind them.

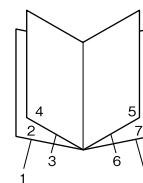

Printing to fold each page in half

This function prints a booklet ready for side binding, fold each sheet individually in half, and then bind at the side of the printout. This setting is suitable for documents that have many pages.

For example, 40 pages of an A4 size document are printed, then each sheet is folded in half and stacking them all makes an A5 size booklet of 40 pages.

Printing Tasks

- 1 Select **Auto (Long-edge binding)** or **Auto (Short-edge binding)** in the 2-sided Printing list box and click **Settings**.

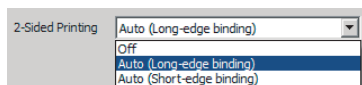

- 2 Select the **Booklet** check box and select **Side Binding**.

- 3 Click **OK** to close setting dialog box.

- 4 Print the document, fold in half 5 sheets by 5 sheets, overlap all sheets, and then bind them.

Printing data for a single page across multiple sheets (poster printing)

Print data for a single page across multiple sheets. Pasting the paper together after it has been printed creates a large, poster-like printout.

Example: Printing the data for A4 size paper in 4 parts on A4 paper (2 × 2 poster) and pasting them together makes a poster that is about A2 size.

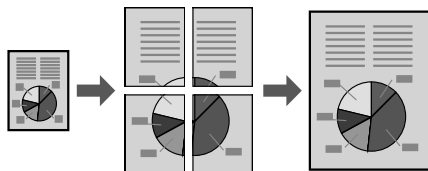

Print by dividing a page of data into multiple sheets (poster printing)

- 1 Turn 2-Sided Printing Off in Main.
- 2 On Multi-Page, select how to divide the data.
 - 2x1Poster: Divided into 2 parts (prints on 2 pages)
 - 2x2Poster: Divided into 4 parts (prints on 4 pages)
 - 3x3Poster: Divided into 9 parts (prints on 9 pages)
 - 4x4Poster: Divided into 16 parts (prints on 16 pages)
 Preview the printout by clicking Settings.

- 3 If you want to print alignment marks, select Settings - Print Cutting Guides, select either one, and then click **OK**.

Overlapping Alignment Marks: Print guides (refer to “How to Stick Papers Together” on page 55)

Trim Lines: Only print lines

- 4 Select the paper source and the size of the paper on which to print and other settings.

Do any other necessary settings.

- 5 Click **OK**, and then click **Print**.

How to Stick Papers Together

This section explains how to stick papers together an example of a 2x2Poster with Overlapping Alignment Marks as an example. Stick the papers together using the following steps.

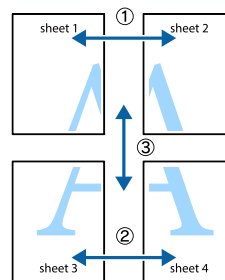

- 1 Cut along the line joining the top and bottom of Sheet 1 - the vertical line (blue) intersecting the × marks.

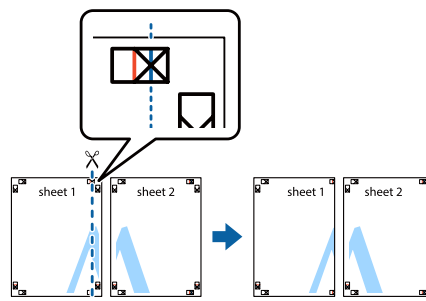

Printing Tasks

- 2** Lay Sheet 1 on Sheet 2 so that the × marks align. Place tape on the back to hold it temporarily.

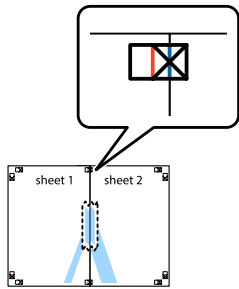

- 3** Cut along the vertical line (red) joining the left sides of the × marks.

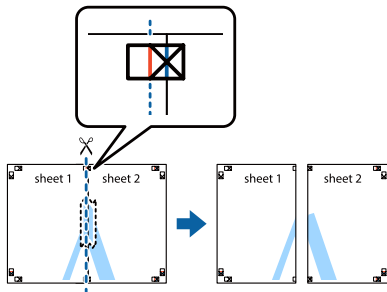

- 4** Stick the paper together by placing tape on the back.

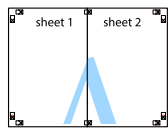

- 5** Stick Sheet 3 and Sheet 4 together.
Repeat steps 1 and 4.

- 6** Cut along the horizontal line (blue) that intersects the × marks on Sheet 1 and Sheet 2.

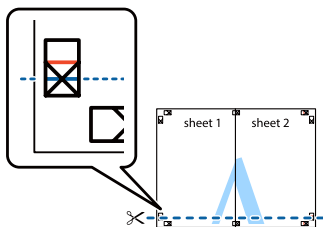

- 7** Lay Sheet 1 and Sheet 2 on Sheet 3 and Sheet 4 so that the × marks align. Place tape on the back to hold it temporarily.

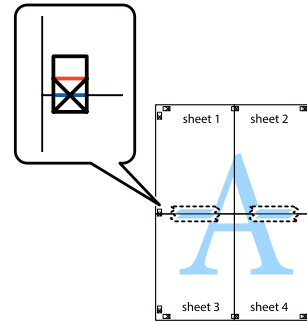

- 8** Cut along the horizontal line (red) joining the top sides of the × marks.

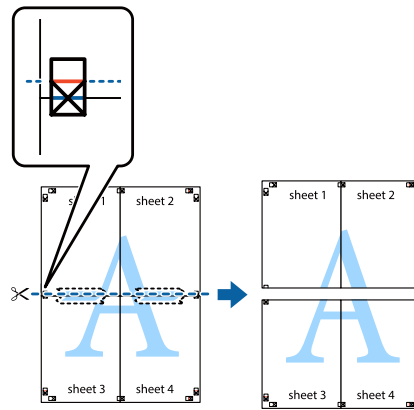

- 9** Stick the paper together by placing tape on the back.

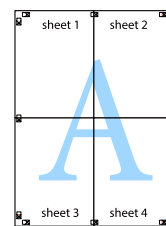

Printing Tasks

- 10** Cut off the margins along the outer alignment marks.

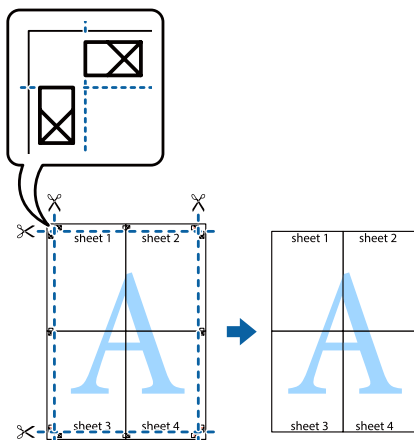

Using the Reserve Job function (AL-M320DN/AL-M310DN)

This function allows you to store print jobs on the printer's memory and to print them later directly from the printer's control panel. You can prevent the printed document from being looked at by other people by applying a password to the print job.

This function uses the following memory.

Printer's Storage	Description
RAM Disk	To enable the RAM disk, you have to set the RAM Disk setting on the control panel to Normal or Maximum.

The table below gives an overview of the options.

Option	Description
Re-Print Job	Lets you print the job now and store it on the printer's memory. You can print the same job several times.
Verify Job	Lets you print one copy now to verify the content. You can print multiple copies later.
Confidential Job	Lets you apply a password to the print job. You can print the job by entering the password on the printer's control panel. See "Using Confidential Job" on page 57 .

Using Re-Print Job/Verify Job (Quick Print Job feature)

Sending the print job

- 1 Click the **Maintenance** tab, then click **Reserve Jobs Settings**. The Reserve Jobs Settings dialog box appears.
- 2 Select the **Reserve Jobs** check box, then select **Re-Print Job** or **Verify Job**.
- 3 Enter a user name and job name in the corresponding text boxes.
- 4 Click **OK**.

Printing using the Quick Print Job Menu

- 1 Make sure the LCD panel displays **Ready**, then press the **▶ Right** button to access the control panel menus.
- 2 Press the **▼ Down** button repeatedly until **Quick Print Job Menu** appears on the LCD panel, then press the **▶ Right** button.
- 3 Use the **▼ Down** or **▲ Up** button to scroll to the appropriate user name, then press the **▶ Right** button.
- 4 Use the **▼ Down** or **▲ Up** button to scroll to the appropriate job name, then press the **▶ Right** button.
- 5 Press the **▶ Right** button, then use the **▼ Down** and **▲ Up** buttons to select the number of copies.

To delete the print job without printing any copies, press the **▼ Down** button to display **Delete** on the LCD panel.
- 6 Press the **▶ Right** button to start printing or to delete the data.

Using Confidential Job

Sending the print job

- 1 Click the **More Options** tab, then click **Confidential Job**. The Confidential Job Settings dialog box appears.

Printing Tasks

2 Enter a four-digit number for Password.

3 Enter a user name and job name if necessary.

Note:

The **OK** button becomes available after the password has been entered.

4 Click **OK**.

Printing using the Confidential Job Menu

1 Make sure the LCD panel displays **Ready**, then press the ► **Right** button to access the control panel menus.

2 Press the ▼ **Down** button repeatedly until **ConfidentialJobMenu** appears on the LCD panel, then press the ► **Right** button.

3 Use the ▼ **Down** or ▲ **Up** button to scroll to the appropriate user name, then press the ► **Right** button.

4 Enter your four-digit password.

To enter the password, press the ▼ **Down** or ▲ **Up** button to select the character and press the ► **Right** button to determine the character. After all characters are determined, press the ► **Right** button.

Note:

If no print jobs have been saved with the password you entered, **Wrong Password** appears briefly on the LCD panel then the printer exits the control panel menus. Confirm the password and try again.

5 Use the ▼ **Down** or ▲ **Up** button to scroll to the appropriate job name, then press the ► **Right** button.

6 Use the ▼ **Down** or ▲ **Up** button to display **Print**.

To delete the print job, press the ▼ **Down** or ▲ **Up** button to display **Delete** on the LCD panel.

7 Press the ► **Right** button to start printing or to delete the data.

Printing with an overlay

This function allows you to print documents onto form templates, which you register on your printer in advance.

Note:

- This function is for Windows only.
- The application featured in these instructions is Microsoft WordPad. The actual procedure may differ slightly when printing from other applications.

Creating an overlay

Note:

You first need to install EPSON FormOverlayUTL utility to create overlay or underlay data. See [“Installing Software”](#) on page 64 for details.

Follow the steps below to create the form data.

1 Open the data to be an overlay data using an application.

2 Select **Print** from the File menu, select **EPSON FormOverlayUTL**, then click **Preferences**.

3 In the Basic Settings tab — Form Overlay — Create Overlay Data, click **More Settings**. The Create Form dialog box appears.

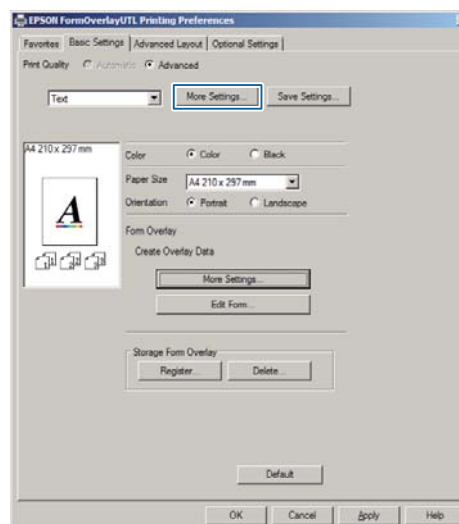

Printing Tasks

- 4 Type the form name in the Form data box and its description in the Description box.

Note:

The following 9 characters cannot be used for form names: \ / : * ? " < > |.

- 5 Select **Foreground Document** or **Background Document** to specify whether the overlay will be printed as foreground or background of the document, then click **OK**.

- 6 Make the appropriate settings for other settings such as paper size, print quality or orientation.

- 7 Click **OK**.

- 8 Click **Print** to create the form data.

Note:

To change the settings of the overlay form data you created, after doing steps 1 and 2 and the settings in the Basic Settings tab — Form Overlay — Create Overlay Data, click the **Edit Form**.

Printing an overlaid document

- 1 Open the document on which you want to overlay the form data.
- 2 Select **Print** from the File menu, select your printer name, then click **Preferences**.
- 3 In the More Options tab, check the **Form Overlay** check box, and click **Settings**. The Form Selection dialog box appears.
- 4 Select one form data in the Form data box, select **Overlay** or **Underlay** in the Layering list, then click **OK**.
- 5 Click **OK**.
- 6 Click **Print** to print the document with the form data.

Improving the clarity of color documents

Printing text clearly in black

When you print a color document, the quality of text can be made more legible by printing it in black.

- 1 Click the **More Options** tab, and click **Image Options**.
- 2 Select **Print Text in Black** from the Visibility drop-down list.
- 3 Click **OK**.

For more information, see the printer driver help.

Making Printer Settings (AL-M220DN only)

You can check and set printer items that are frequently used such as Cassette1 Size, Cassette1 Type, Time Setting, and Time to Sleep, from the Printer Settings menu in the printer driver.

On how to access this menu and what items you can set, see [“How to access the control panel menus \(AL-M320DN/AL-M310DN\)”](#) on page 17.

Note:

A warning appears if the time is not set after purchasing the printer. Use Printer Settings to set the time.

Using Sleep Mode to Save Energy

Your printer can enter sleep mode (or deep sleep mode) to save energy.

You can know whether the printer is in sleep mode (or deep sleep mode).

For AL-M320DN/AL-M310DN:
The **Wakeup/Sleep** button is lit.

Printing Tasks

For AL-M220DN:
The **Ready** light flashes.

Note:

To wake up the printer from sleep mode, do one of the following operations:

- Press the Wakeup/Sleep button (For AL-M320DN/AL-M310DN)
- Press any button (for AL-M220DN)
- Turn the printer off and then back on
- Send a print job to the printer

Entering the sleep mode manually (For AL-M320DN/AL-M310DN)

To immediately enter the sleep mode, press the Wakeup/Sleep button.

Entering the sleep mode automatically

Setting the time-to-sleep time

Selecting a value from the time-to-sleep options in the Energy Saver Menu.

Item	Value
Time to Sleep(Auto)	Disable (default)
Time to Sleep	1 minute by default, or you can select a value. For the values, see "Energy Saver Menu" on page 25.

To make a weekly sleep schedule, see "Making a weekly sleep schedule" on page 60.

Selecting the value (time) which is calculated from the printer's operation history

Item	Value
Time to Sleep(Auto)	Enable
Time to Sleep	-

To make a weekly sleep schedule, see "Making a weekly sleep schedule" on page 60.

Making a weekly sleep schedule

This section shows an image of a weekly sleep schedule.

See "Sleep Schedule Menu" on page 27 for the setting items.

Use EpsonNet Config with a web browser for these settings. See the *Network Guide* for the procedure to access EpsonNet Config with a web browser.

Note:

Changing the settings for Time to Sleep (Auto), Time to Sleep, and Sleep Schedule may affect printer power consumption, the service life of the fuser unit (the maintenance unit for AL-M320DN/AL-M310DN), or the printer (for AL-M220DN).

Example of one day sleep schedule:

The printer is set to immediately enter the sleep mode during the time in shaded areas.

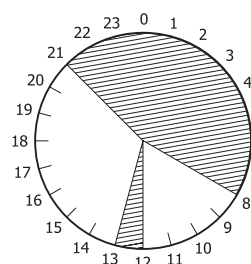

Example of one week sleep schedule:

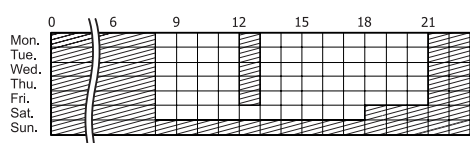

Printing Tasks

Note:

- ❑ If Deep Sleep Mode is set to On (default), the printer enters deep sleep mode and consumes less power.
- ❑ The printer cannot enter the deep sleep mode under the following conditions:
 - MS Network in the Network Menu is set to On.
 - Network in the Emulation Menu is set to PS3.
 - Network Administrator - UPnP - Universal Plug and Play in EpsonNet Config (web version) is enabled (default).
- ❑ The printer may not enter the deep sleep mode immediately under the following conditions:
 - A network communication has been planned to start within a minute.
 - Bonjour is set to On (default) and within 10 minutes after the printer has been turned on.

Changing the Printer Driver's Default Settings (for Administrators)

Note:

- ❑ The explanations below use Windows 7 as an example.
- ❑ Power User or higher privileges are required to change the printer driver's default settings.

Changing the default settings

Access the printer driver's properties from Start - Devices and Printers. The settings you change becomes the new default values for printing from all applications.

However, if you access the properties from an application, the changed settings are only temporarily available in that application.

Locking the default settings

The settings for functions, such as Watermark and Header/Footer, can be locked to prevent users from changing the printer driver settings.

1

Access the printer driver's properties from Start - Devices and Printers.

2

Access the Optional Settings tab, click the Driver Settings button, and select the functions you want to lock.

3

Click OK.

Using EPSON Status Monitor

Accessing EPSON Status Monitor

EPSON Status Monitor is a utility program on your computer that monitors your printer and gives you information about its current status such as printer errors, the remaining service lives of the replacement parts, or progress of printing.

To install the utility, see [“Installing Software” on page 64](#).

With this utility installed, Simple Status appears on the computer screen when an error occurs. Clicking the **Details** button displays the Detailed Status.

Simple Status:

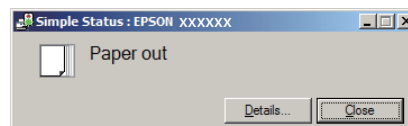

Detailed Status:

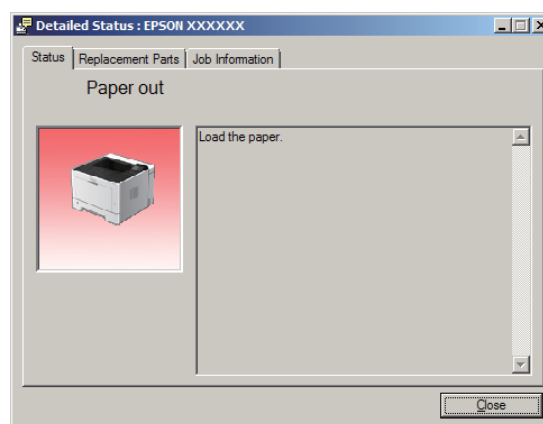

Printing Tasks

When you want to know the current status of the printer, click the EPSON Status Monitor tray icon on the taskbar, then select the printer name and menu you want to access.

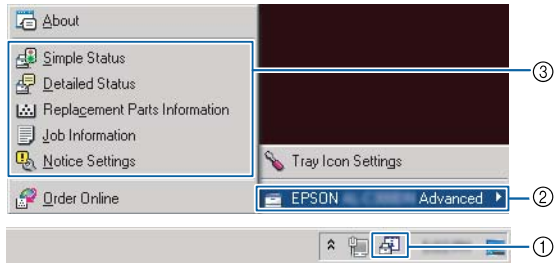

When you want to know the remaining service lives of the replacement parts, click **Replacement Parts Information**.

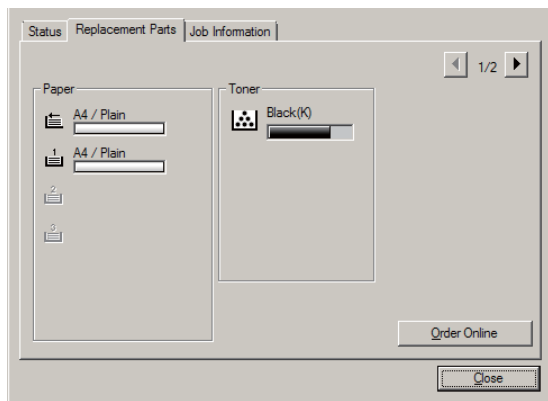

Notice Settings

This setting decides what states of the printer the utility sends you a notice.

Accessing from the taskbar:

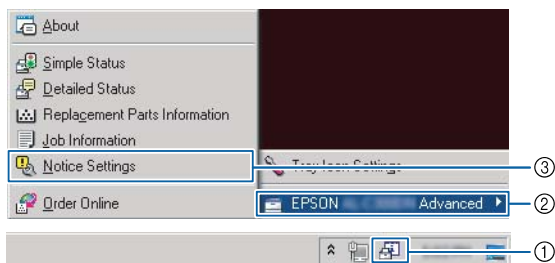

Accessing from the printer driver:

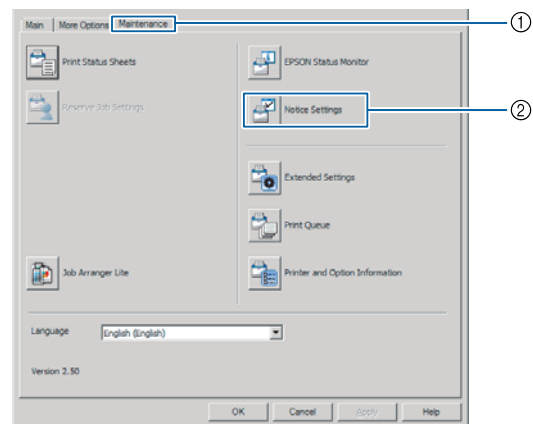

Tray Icon Settings

This setting decides the screen to be opened when you double-click the EPSON Status Monitor tray icon on the taskbar.

- 1 Right-click the tray icon on the taskbar and click **Tray Icon Settings**.
- 2 Set the printer name and information to display in the Tray Icon Settings.

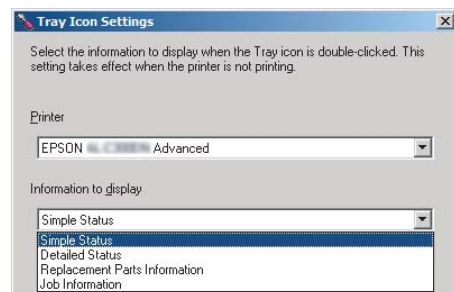

Cancelling a Print Job

This section describes how to delete and cancel a print job in the computer or in a printer.

From the printer

For AL-M320DN/AL-M310DN

Follow the steps below to cancel a job.

- 1 Press the **Pause/Release** button.

Printing Tasks

- 2 Press the ▼ **Down** or ▲ **Up** button to select the job that you want to cancel, then press the **OK** button.
- 3 Press the ▼ **Down** or ▲ **Up** button to select **Cancel Job**, then press the **OK** button. Printing is canceled.

Note:

Select **Cancel All Jobs** in step 3 to cancel all print jobs in the printer's memory.

For AL-M220DN

To cancel a job, press the  **Job Cancel** button on the printer's control panel.

From the computer

For Windows

- 1 Click the **Maintenance** tab on the printer driver, then click **Print Queue**.
- 2 Right-click the job you want to cancel, and select **Cancel**.

Uninstalling and Installing Software

Uninstalling and Installing Software

Uninstalling Software

You must uninstall the software before you can upgrade it or reinstall it.

Note:

- Uninstalling the printer software may require administrator privileges.
- Restart the computer before you reinstall the software you uninstalled.

To uninstall the printer software, close all applications first, and then uninstall the printer software from the following menu on the Control Panel.

- Uninstall a Program** (for Windows 10, Windows 8.1, Windows 8, Windows Server 2012/R2, Windows Server 2016)
- Program and Features** (for Windows 7, Windows Vista, Windows Server 2008/R2)
- Change or Remove Programs** (for Windows XP or Windows Server 2003)

Select the printer software that you want to uninstall, and then click the item below.

- Uninstall/Change** (for Windows 10, Windows 8.1, Windows 8, Windows 7, Windows Vista, Windows Server 2008/R2, Windows Server 2016)
- Change/Remove** (for Windows XP or Windows Server 2003)

Note:

If you uninstall the printer driver, EPSON Status Monitor is also uninstalled.

Note for Mac OS users:

- To uninstall all drivers for Epson page printer at once, use the uninstaller. Download the uninstaller from the Epson website.
<http://www.epson.eu/Support> (Europe)
<http://support.epson.net/> (outside Europe)
- To use the uninstaller, double-click the uninstaller icon, from the list displayed select the check box for the printer software you want to uninstall, then click **Uninstall**.

Installing Software

If you want to install or reinstall software you did not install in the setup, you can choose the software and install it.

Note:

- Uninstalling the printer software may require administrator privileges.
- Restart the computer before you reinstall the software you uninstalled.

- 1** Close all applications.
- 2** To install the printer driver via a USB interface, disconnect the USB cable from the printer and do not connect it until instructed to do so.
- 3** Go to the following Epson web site to download and install the printer software.
<http://www.epson.eu/Support> (Europe)
<http://support.epson.net/> (outside Europe)

Note:

- For Windows users, if the computer has a disc drive, you can install the printer driver from the Software Disc that came with your printer.
- The following Epson websites are available for Windows users who want to install the ESC/Page printer driver.
<http://epson.sn/>

Uninstalling and Installing Software

Installing the PostScript printer driver with Windows

To print in the PostScript mode, you will have to install the printer driver. See the appropriate sections below for installation instructions according to the interface that you are using to print.

Installing the PostScript printer driver for the USB interface

Note:

- Installing the printer software for Windows may require administrator privileges. If you have problems, ask your administrator for more information.
- Turn off all virus protection programs before installing the printer software.

- 1** Make sure that the printer is turned off. Insert the printer Software Disc into your disc drive.

Note:

If your computer does not have a disc drive, download the driver from the Epson website. <http://www.epson.eu/Support> (Europe)

- 2** Connect your computer to the printer with a USB cable, then turn on the printer.

Note for Windows Vista users:

Without the Windows driver or the PostScript driver, the display shows "Found New Hardware." In this case, click **Ask me again later**.

- 3** Select **Devices and Printers**, and click the **Add a printer** button.

For Windows 10 and Windows Server 2016, right-click the start button or press and hold it, select **Control Panel**, click **View devices and printers**, then click **Add a printer** button.

For Windows 8.1 or Windows 8, right-click the bottom left corner of the screen in the desktop style, select **Control Panel**, click **View devices and printers**, then click **Add a printer** button.

For Windows Vista, Windows XP, or Windows Server 2008/R2, click **Start**, point to **Printer and Faxes**, then click **Add a printer** in the Printer Tasks menu.

For Windows Server 2003, click **Start**, point to **Settings**, and click **Printers**. Then double-click the **Add Printer** icon.

The Add Printer Wizard appears.

- 4** Select **Add a local printer**.

For Windows XP or Windows Server 2003, click **Next** to proceed the next screen, select **Local printer**, then click **Next**.

Note:

Do not select the **Automatically detect and install my Plug and Play printer** check box.

- 5** Select **USB** as the port the printer is connected to, then click **Next**.

- 6** Click **Have Disk** and specify the following path for the Software Disc. If your disc drive is D:, the path will be D:\Driver\PostScript\epsnt.inf. Then click **OK**.

Note:

Change the drive letter as needed for your system.

- 7** Select the printer, then click **Next**.

- 8** Follow the on-screen instructions for the rest of the installation.

- 9** When installation is done, click **Finish**.

Installing the PostScript printer driver for the network interface

Note:

- Set the network settings before installing the printer driver. Refer to the Network Guide for your printer for details.
- Turn off all virus protection programs before installing the printer software.

Uninstalling and Installing Software

- 1 Make sure that the printer is turned on. Insert the printer Software Disc into your disc drive.

Note:

If your computer does not have a disc drive, download the driver from the Epson website.
<http://www.epson.eu/Support> (Europe)

- 2 Select **Devices and Printers**, and click the **Add a printer** button.

For Windows 10 and Windows Server 2016, right-click the start button or press and hold it, select **Control Panel**, click **View devices and printers**, then click **Add a printer** button.

For Windows 8.1 or Windows 8, right-click the bottom left corner of the screen in the desktop style, select **Control Panel**, click **View devices and printers**, then click **Add a printer** button.

For Windows Vista, Windows XP, or Windows Server 2008/R2, click **Start**, point to **Printer and Faxes**, then click **Add a printer** in the Printer Tasks menu.

For Windows Server 2003, click **Start**, point to **Settings**, and click **Printers**. Then double-click the **Add Printer** icon.

The Add Printer Wizard appears.

- 3 Select **Add a local printer**.

For Windows XP or Windows Server 2003, click **Next** to proceed the next screen, select **Local printer**, then click **Next**.

Note:

Do not select the **Automatically detect and install my Plug and Play printer** check box.

- 4 Select the **Create a new port** check box and select **Standard TCP/IP Port** from the drop-down list. Click **Next**.

- 5 (For Windows XP or Windows Server 2003 users only) Click **Next**.

- 6 Specify the IP address and port name, then click **Next**.

- 7 Click **Finish**.

- 8 Click **Have Disk** in the Add Printer Wizard and specify the following path for the Software Disc. If your disc drive is D:, the path will be D:\Driver\PostScript\eppsnt.inf. Then click **OK**.

Note:

Change the drive letter as needed for your system.

- 9 Select the printer and click **Next**.

- 10 Follow the on-screen instructions for the rest of the installation.

- 11 When installation is done, click **Finish**.

Installing the PostScript printer driver with Mac OS

Installing the PostScript printer driver

Go to the following Epson support website to download and install the driver.

<http://www.epson.eu/Support> (Europe)

Selecting the printer

After installing the PostScript printer driver, you need to select the printer.

In a network environment

Note:

- You need to make the settings for your installed options manually when the printer is connected using USB, IP printing, or Bonjour.
- Make sure to specify ASCII as the data format in the application.

- 1 Open the System Preferences, and then double-click the Print & Fax ("Print & Scan" for Mac OS X 10.7 or later) icon. The Print & Fax ("Print & Scan" for Mac OS X 10.7 or later) window appears.

Uninstalling and Installing Software

2 Click  in the Printers window.

3 Select the printer name that you are using from the printer name box.

Note:

If your printer is not listed, check that it is correctly connected to the computer and that the printer is on.

4 Click **Add**.

5 Confirm that your printer's name is added to the Printers list. Then quit **Print & Fax** ("**Print & Scan**" for Mac OS X 10.7 or later).

3 Follow the on-screen instructions for the rest of the installation.

4 After the installation is done, access your printer's **Properties** and **Printing Preferences** to customize the printer driver settings.

Installing the PCL printer driver (For Windows only)

Epson Universal Print Driver is the universal PCL6 compatible print driver that has the following features:

- It supports the basic print functions needed for business situations.
- It supports multiple Epson business printers besides this printer.
- It supports most languages among the print drivers for this printer.

Note:

It also supports printing in ESC/Page mode.

1 Download the driver's executable file from the Epson support website.

<http://www.epson.eu/Support> (Europe)

<http://support.epson.net/> (outside Europe)

Note:

We recommend downloading the latest driver from the website. However you can also find it on the software disc that came with the printer. Access "Driver\Universal".

2 Double-click the executable file that you downloaded from the website or that is on the software disc.

Maintaining the Printer

Maintaining the Printer

Replacing Consumable Products/Maintenance Parts

Precautions during replacement

Always observe the following handling precautions when replacing consumable products/maintenance parts.

For details about the replacements, see the instructions that come with the consumable products.



Caution:

- Be careful not to touch the fuser, which is marked with a caution label, or the surrounding areas. If the printer has been in use, the fuser and surrounding areas may be very hot.
- Do not dispose of used consumable products/maintenance parts in fire, as they may explode and cause injury. Dispose of them according to local regulations.

- Provide enough space for the replacement procedure. You will have to open some parts (such as the printer cover) of the printer when you are replacing consumable products/maintenance parts.
- Do not install used consumable products that reach end of service life into the printer.

For details about the handling precautions, see [“Handling the consumable products and maintenance parts” on page 9](#).

If a consumable product reaches the end of its service life, the printer displays the following message on the LCD panel or the window of EPSON Status Monitor.

Replacement Messages/Lights











For AL-M320DN/AL-M310DN

LCD Panel Message	
	Replace Toner Cartridge
	Replace Maintenance Unit A
	Replace Maintenance Unit B

For AL-M220DN

	light on
	Light off
—	Status-specific (either lit, blinking, or unlit)

Maintaining the Printer

					Data	Statuses and handling methods (status monitor messages in bold)
					—	<p>Replace Toner cartridge</p> <p>The toner cartridge has reached the end of their service life and need to be replaced.</p> <p>For details about replacement, see the instructions that come with the toner cartridge.</p>

Maintaining the Printer

Cleaning the Printer

The printer needs only minimal cleaning to keep it in good condition.

If the printer's outer case is dirty or dusty, turn off the printer and clean it with a soft, clean cloth moistened with a mild detergent.



Important:

Never use alcohol or paint thinner to clean the printer cover. These chemicals can damage the components and the case. Be careful not to get water onto the printer mechanism or any electrical components.

Cleaning the inner roller

1 Turn the printer off, wait until the operation panel is unlit, and then unplug the power plug from the outlet.

2 Press the button on the top, then open covers F1 and F2.

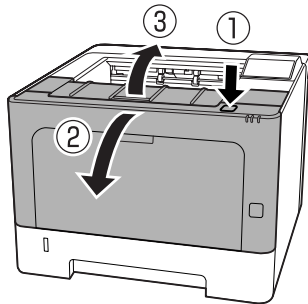

Important:

Do not touch the inner rollers and gears. Doing so may cause malfunctions or a deterioration in print quality.

3 Press lever A on left side.

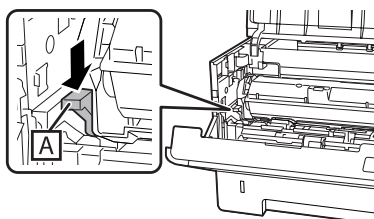

4 Remove the maintenance unit A.

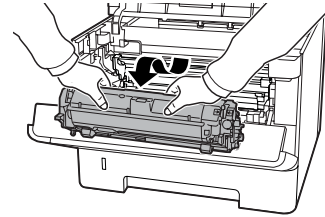

5 Place maintenance unit A horizontally in a clean location.

Do not stand it on end.

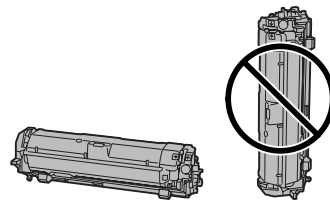

6 Remove the maintenance unit B while holding section B.

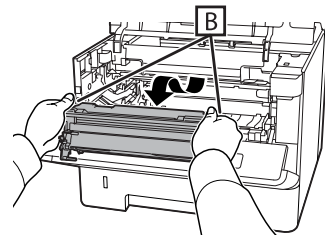

7 Place maintenance unit B horizontally in a clean location.

Do not stand it on end.

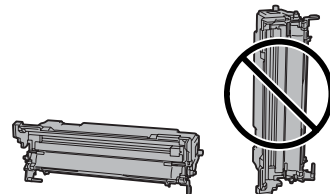

Maintaining the Printer

- 8** Gently wipe the metallic roller inside with a soft and dry cloth to remove the grime and paper particles.

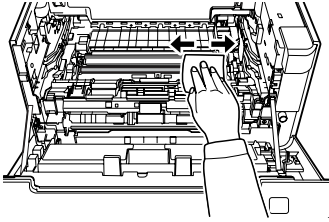

- 9** Hold the grip of the cleaner on the top part of maintenance unit B and move it back and forth, 2 or 3 times.

The first time you do this work, remove the tape stuck securing grip, and then move it.

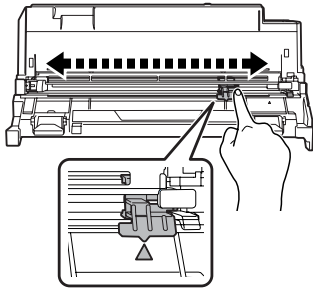

- 10** Return the grip to its original position (▲ mark).

Make sure to return the grip to the ▲ mark position. If it is not in this position, you will not be able to remove Maintenance Unit B the next time.

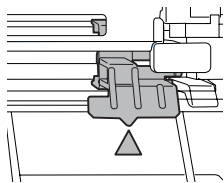

- 11** Insert the maintenance unit B.

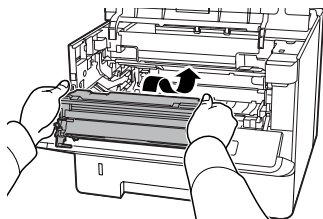

- 12** Insert the maintenance unit A.

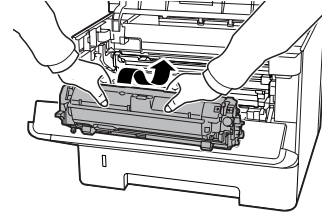

- 13** Close covers F1 and F2.

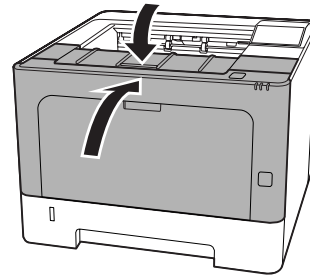

Troubleshooting

Troubleshooting

Status and Error Messages on the Control Panel (for AL-M320DN/AL-M310DN)

This section describes the messages and the meaning of the messages that appear on the LCD panel.

When the **◆** mark is displayed at the right of the warning message, multiple warnings have occurred. Pressing the **▲ Up** or **▼ Down** buttons displays the warnings.

Note:

- ❑ If **◀ Press for help** is displayed on the LCD panel, press the **◀ Left** button to show the help. Then press the **▼ Down** button for next step, the **▲ Up** button for previous step, or **◀ Left** button to close the help.
- ❑ To clear a warning message, select **Reset Menu** in **Common Settings** from the control panel, then select **Clear Warnings**. See [“How to access the control panel menus \(AL-M320DN/AL-M310DN\)”](#) on page 17 for instructions.

Adjusting Printer

Wait a few minutes. Do not open or close the covers, or turn off the printer until this message disappears.

Bookmark Failed

The selected menu cannot be registered as a bookmark. Some menus cannot be registered as bookmarks.

Bookmark Registered

The selected menu is registered as a bookmark.

Canceling All Job

The printer is canceling all print jobs in the printer memory, including jobs the printer is currently receiving or printing. This message appears when **Cancel All Jobs** is selected on the control panel.

Canceling Job

The printer is canceling the specified print job and the current print job. This message appears when **Cancel Job** is selected after you specify the file to be canceled on the control panel.

Can't Print

The print data is deleted because it is incorrect.

Make sure the appropriate paper size and printer driver are used.

Can't Print Duplex

The printer has encountered problems during duplex printing. Make sure you are using an appropriate type and size of paper for the duplex printing. The problem could also be a result of incorrect settings for the paper source you are using. Pressing the **OK** button will print the rest of the print job on only one side of the paper. To cancel the print job, see [“Canceling a Print Job”](#) on page 62.

Can't Use Bookmark

The registered menu cannot be used because the menu is disabled by changing any settings after registered the menu in bookmark.

Check Cassette xx (AL-M320DN/AL-M310DN only)

This is the message that appears when warnings are set for no cassettes and no paper.

The cassette that is indicated by an "x" either has no paper or the cassette is missing. Correctly load the paper and cassette, and then press the **OK** button.

Check Media Type

The paper loaded in the printer does not match the paper type setting in the printer driver. Paper that matches only the paper size setting will be used for printing.

To clear this warning message, select **Clear Warnings** from the control panel's **Reset Menu**.

Check Paper Size

The paper size setting is different from the size of paper loaded in the printer. Check to see if the correct size of paper is loaded in the specified paper source.

Troubleshooting

To clear this warning message, select **Clear Warning** from the control panel's **Reset Menu**.

Clear Paper Jam **www**

The location where the paper jam occurred is displayed at **www**. **www** indicates the location of the error.

If a paper jam occurs at two or more locations simultaneously, the corresponding multiple locations are displayed.

For details about clearing paper jams, see [“Clearing Jammed Paper” on page 84](#).

Close Cover **www**

The specified cover (**www**) does not close securely. Open the cover once, and then close.

Collate Disabled

Printing by specifying the number of copies is no longer possible due to a lack of memory (RAM). If this warning message appears, print only one copy at a time.

To clear this warning message, select **Clear Warning** from the control panel's **Reset Menu**.

Correct Time using Time Setting

The time and date are at their default values. Set the time and date.

To clear this warning message, select **Clear Warning** from the control panel's **Reset Menu**.

Duplex Memory Overflow

There is not enough memory for duplex printing. The printer prints only on the front and ejects the paper. To clear this error, follow the instructions below.

If **Off** is selected as the **Auto Cont** setting on the control panel's **Setup Menu**, press the **OK** button to print on the back of the next sheet, or cancel the print job. To cancel the print job, see [“Cancelling a Print Job” on page 62](#).

If **On** is selected as the **Auto Cont** setting on the control panel's **Setup Menu**, printing continues automatically after a certain period of time.

F/W Update

Firmware is being updated. Do not turn off the power until the update is complete.

F/W Update: Error

The firmware update failed. Turn the power off and on, and then try to update again.

Feed Roller C1 Needed Soon, Feed Roller C2 Needed Soon (AL-M320DN only), Feed Roller C3 (AL-M320DN only)

This warning message indicates that the indicated feed roller is near the end of its service life. You can continue printing until a message to replace the indicated feed roller appears.

Filling Toner **mm min**

Wait **mm** minutes for the toner to fill.

Form Feed

The printer is ejecting paper due to a user request. This message appears when pressing the **Pause/Release** button once, then holding down the **OK** button for more than 2 seconds because the printer has not received a form feed command.

Fuser Needed Soon (AL-M320DN only)

This message indicates that the fuser unit is near the end of its service life. You can continue to print until the **Replace Fuser** message appears.

Image Optimum

There is insufficient memory to print the page at the specified print quality. The printer automatically lowers the print quality so that it can continue printing. If the quality of the printout is not acceptable, try simplifying the page by limiting the number of graphics or reducing the number and size of fonts.

To clear this warning message, select **Clear Warning** from the control panel's **Reset Menu**.

Install Toner Cartridge

The toner cartridge is not installed in the printer.

Install the toner cartridge. See the instructions that come with the toner cartridge.

Invalid Data

Troubleshooting

The spool file on the driver is deleted while printing or the data is abnormal. Press the **OK** button to clear the error.

Invalid PS3

There are errors in the ROM module. Turn off the printer and contact your dealer.

Maintenance Unit A Needed Soon, Maintenance Unit B Needed Soon

The indicated maintenance unit is near the end of its service life. You can continue to print until the `Replace Maintenance Unit A` or `Replace Maintenance Unit B` message appears. To clear this warning message and continue printing, select `Clear All Warnings` from the control panel's `Reset Menu`.

Manual Feed ssss

The manual feed mode is specified for the current print job. Make sure the paper size indicated by `ssss` is loaded, then press the **OK** button.

Memory Overflow

The printer has insufficient memory to execute the current task. Press the **OK** button on the control panel to resume printing, or cancel the print job. To cancel the print job, see [“Cancelling a Print Job” on page 62](#).

Need Memory

The printer has insufficient memory to complete the current print job.

To clear this warning message, select `Clear Warning` from the control panel's `Reset Menu`.

To prevent this problem from recurring, reduce the resolution of the image to be printed.

No trays available (AL-M320DN/AL-M310DN only)

No trays are selected in `Printer Settings > Tray Menu`

- MP Tray AutoSel
- Cassette1 AutoSel
- Cassette2 AutoSel
- Cassette3 AutoSel

Press **Pause/Release** button and cancel the print job.

Non-Genuine Toner Cartridge

The installed toner cartridge is not a genuine Epson toner cartridge. Installing a genuine toner cartridge is recommended.

The printout and remaining service life of the toner cartridge displayed on the control panel may be different from those when using genuine Epson toner cartridges. Epson shall not be liable for any damages or problems arising from the use of consumable products not manufactured or approved by Epson.

Press the **OK** button on the control panel to resume printing.

Paper Out XX

This appears in the following situations.

- Paper is not loaded in paper source "xxxxx" from which the printer tried to feed. Loading size "yyyy" paper into paper source "xxxxx" clears the error and printing starts.
- There is no paper loaded in any paper source. Loading paper into any paper source clears the error and printing starts.
- Paper cassette is not inserted correctly. Slowly push the cassette all the way in, and then confirm that it is securely inserted.
- A4 or LT size is not loaded in paper source "xxxxx" when the setting for A4/LT Auto Switching is something other than Off.

To print, load A4 or LT size paper into paper source "xxxxx", and then press the **OK** button.

To cancel printing, press the **WakeUp/Sleep** button, and then cancel by selecting a job operation.

Paper Out tttt sssss

There is no paper in the specified paper source (tttt). Load paper of the size (sssss) into the paper source.

Paused

A state in which print data is created and data is received, but the print operation does not start. Pressing the **Pause/Release** button returns the printer to a printable state.

Printing restarts if the printer is left paused for about a minute.

Please Wait

Troubleshooting

Printing cannot start because the previous job is being processed. Try again after a few seconds.

Print Overrun

The required time to process the print data exceeded the print engine speed because the current page is too complex. Press the **OK** button to resume printing, or cancel the print job. To cancel the print job, see [“Cancelling a Print Job” on page 62](#). If this message appears again, select **On** as the **Page Protect** setting in the control panel's **Setup Menu**.

If you continue to receive this message when printing a particular page, try simplifying the page by limiting the number of graphics or reducing the number and size of fonts.

RAM CHECK

The printer is checking the RAM.

Ready

The printer is ready to receive data and print.

Reboot to apply settings

You selected **No** when **Do you want to reboot to apply the settings?** was displayed. To clear this warning message, select **Clear Warnings** from the control panel's **Reset Menu**.

Recovery Mode

Because the firmware update failed, the printer started in recovery mode. Use the steps below to try to update the firmware again.

1. Connect the computer and the printer with a USB cable (network connections cannot be done for updates during recovery mode).
2. Download the newest firmware from the Epson web site, and then update.

Replace Feed Roller C1, Replace Feed Roller C2, Replace Feed Roller C3 (AL-M320DN only)

The indicated feed roller has reached the end of its service life and needs to be replaced. Press the **OK** button to clear this error.

Replace Fuser (AL-M320DN only)

The fuser has reached the end of its service life and needs to be replaced. If this error occurs, consult your dealer.

Replace Maintenance Unit A, Replace Maintenance Unit B

The indicated maintenance unit has reached the end of its service life and needs to be replaced. Press the **OK** button to clear this error.

Replace Toner Cartridge

The toner cartridge has reached the end of their service life and needs to be replaced.

For details about replacement, see the instructions that come with the toner cartridge.

Reserve Job Canceled

The printer cannot store the data of your print job using the **Reserve Job** function. The maximum number of print jobs stored on the printer's memory has been reached, or the memory has no more memory available to store a new job. To store a new print job, delete a previously stored job. Also, if you have any **Confidential Job** stored, printing those jobs will make more memory available.

You may also increase the available memory space by changing the **RAM Disk** setting to **Normal** or **Maximum**. For details, see [“Setup Menu” on page 21](#).

To clear this warning message, select **Clear Warnings** from the control panel's **Reset Menu**.

Reset All

All printer's interface has been reset and the buffer has been cleared. The printer reboots automatically.

Reset to Save

A control panel menu setting was changed while the printer was printing. Press the **OK** button to clear this message. The setting will become effective after printing has finished.

Alternatively you can clear this message by performing **Reset All** on the control panel. However, the print data will be deleted.

ROM CHECK

The printer is checking the ROM.

Troubleshooting

Wrong Password (AL-M320DN/AL-M310DN only)

This appears if you change your password in Password Config on the operation panel.

SELF TEST

The printer is currently performing a self test and initialization.

Service Req Cffff/ Service Req Exxx

A controller error or a print engine error has been detected. Turn off the printer. Wait at least a few seconds, then turn it back on. If the error message still appears, write down the error number listed on the LCD panel (Cffff/Exxx), turn off the printer, unplug the power cord, then contact a qualified service representative.

Set Paper tttt pppp

The paper loaded in the specified paper source (tttt) does not match the required paper type (FFFF). Replace the loaded paper with the correct paper type and press the **OK** button to resume printing, or cancel the print job. To cancel the print job, see [“Cancelling a Print Job” on page 62](#).

If you press the **OK** button without replacing the paper, the printer will print on the loaded paper even though it does not match the required paper type.

Set Paper tttt ssss

The paper loaded in the specified paper source (tttt) does not match the required paper size (sssss). Replace the loaded paper with the correct size paper and press the **OK** button to resume printing, or cancel the print job. To cancel the print job, see [“Cancelling a Print Job” on page 62](#).

If you press the **OK** button without replacing the paper, the printer will print on the loaded paper even though it does not match the required size.

Set Paper tttt ssss1 or ssss2

This message appears in the following situations if A4/LT Auto Switching in Setup Menu is set to A4->LT, LT->A4 or A4<->LT:

- When printing a job specified as A4 with the printer driver, there is no paper source that is set as A4 or as LT (alternate size for A4) in the Tray Menu.

- When printing a job specified as letter size with the printer driver, there is no paper source that is set as LT or as A4 (alternate size for LT) in the Tray Menu.

To clear this warning message, make sure that A4 or LT is set to the specified paper source (tttt) in the Tray Menu, load A4 or Letter size paper (ssss1 or ssss2) in the specified paper source (tttt) and click the **OK** button, or cancel the print job. To cancel the print job see [“Cancelling a Print Job” on page 62](#).

Sleep (while the Wakeup/Sleep button is lighting)

The printer is currently in the power-save mode. This mode is canceled when the printer receives print data.

Toner Cartridge Error

There is a problem with the toner cartridge.

Remove the toner cartridge and reinsert it. If that fails to clear the error, replace the toner cartridge with a new one. For details about replacement, see the instructions that come with the toner cartridge.

Toner Low

The toner cartridge is near the end of its service life. Prepare a new toner cartridge.

Turn Paper MP Tray, Turn Paper Cassette1, Turn Paper Cassette2 (AL-M320DN/AL-M310DN only), **Turn Paper Cassette3** (AL-M320DN/AL-M310DN only)

The orientation (portrait or landscape) of the paper that is set in the indicated paper source is not correct. Change the orientation of the paper in the paper source.

Unable Clear Error

The printer cannot clear an error message because the error status still remains. Try solving the problem again.

Warming Up

The printer is warming up the fuser to be ready to print.

Wrong Toner Cartridge

An inappropriate toner cartridge is installed.

Troubleshooting

Install only the toner cartridge listed in [“Consumable Products and Options”](#) on page 109.

Troubleshooting

Status and Error Lights (for AL-M220DN)

You can check the printer status from combinations and patterns of the lights on the control panel.

Note:

You can check the printer status and error easily on the Windows computer by using EPSON Status Monitor. See [“Using EPSON Status Monitor” on page 61](#) for more information.



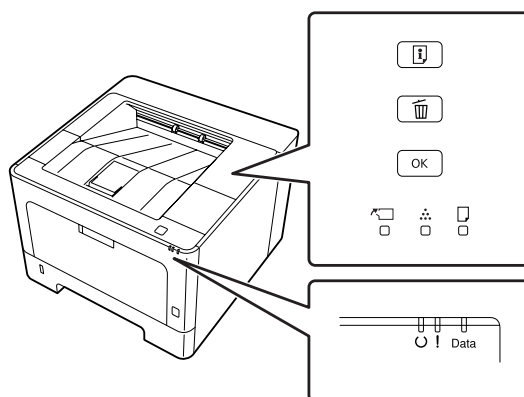





































The status of the lights are illustrated below.











	light on
	blink1: turn on for 0.3 seconds, off for 0.3 seconds
	blink2: turn on for 0.6 seconds, off for 0.6 seconds
	blink3: turn on for 0.6 seconds, off for 2.4 seconds
	blink4: turn on for 1.2 seconds, off for 1.2 seconds
	Light off
—	Status-specific (either lit, blinking, or unlit)

					Data	Statuses and handling methods (status monitor messages in bold)
	—	—	—		—	<p>Correct time using Time Setting</p> <p>Time is not set in the printer. Set time using Time Setting.</p> <p>See “How to access the control panel menus (AL-M220DN)” on page 17.</p>























































Troubleshooting

					Data	Statuses and handling methods (status monitor messages in bold)
					—	<p>Install Toner Cartridge The toner cartridge is not installed in the printer. Install the toner cartridge.</p> <p>Wrong Toner Cartridge An inappropriate toner cartridge is installed. Install only the toner cartridge listed in "Consumable Products and Options" on page 109.</p> <p>Toner Cartridge Error There is a problem with the toner cartridge. Remove the toner cartridge and reinsert it. If that fails to clear the error, replace the toner cartridge with a new one.</p> <p>Replace Toner cartridge The toner cartridge has reached the end of their service life and need to be replaced.</p>
					—	<p>Non-Genuine Toner Cartridge The installed toner cartridge is not a genuine Epson toner cartridge. Installing a genuine toner cartridge is recommended.</p> <p>The printout and remaining service life of the toner cartridge displayed on the control panel may be different from those when using genuine Epson toner cartridges. Epson shall not be liable for any damages or problems arising from the use of consumable products not manufactured or approved by Epson.</p> <p>Press the OK button on the control panel to resume printing.</p>
—		—			—	<p>Toner Low The toner cartridge is near the end of its service life. Prepare a new toner cartridge.</p>
—		—			—	<p>Non-Genuine Toner Cartridge The installed toner cartridge is not a genuine Epson toner cartridge.</p>
					—	<p>Close Cover A cover is open or not closed securely. Open the cover once, and then close it.</p>
					—	<p>Check Paper Size The paper loaded in the specified paper source does not match the required paper size. Replace the loaded paper with the correct size paper and press the OK button to resume printing, or press the Job Cancel button to cancel the print job.</p>
					—	<p>Clear Paper Jam A paper jam occurs. Clear the paper jam. See "Clearing Jammed Paper" on page 84 for instructions.</p>
					—	<p>Manual Feed The Manual Feed setting is selected in the printer driver. Make sure that the desired paper is displayed in the printer driver and loaded in the manual feed slot on the MP tray. You have to press the OK button once when you want to print in manual feed mode. If you want to print from the MP tray or the optional 250-sheet Paper Cassette Unit after printing in the manual mode, be sure to clear the Manual Feed setting in the printer driver settings.</p> <p>Note: <i>Before printing in the manual feed mode, take out the paper from other paper sources.</i></p>

Troubleshooting

					Data	Statuses and handling methods (status monitor messages in bold)
<input type="checkbox"/>	<input type="checkbox"/>	<input checked="" type="checkbox"/>	<input type="checkbox"/>		—	<p>Turn Paper MP Tray, Turn Paper Cassette1</p> <p>The orientation (portrait or landscape) of the paper that is set in the indicated paper source is not correct. Change the orientation of the paper in the paper source.</p>
<input type="checkbox"/>	<input type="checkbox"/>	<input checked="" type="checkbox"/>	<input type="checkbox"/>		—	<p>Can't Print Duplex</p> <p>The printer has encountered problems during duplex printing. The problem could also be a result of incorrect settings for the paper source you are using. Pressing the OK button will print the rest of the print job on only one side of the paper. To cancel the print job, see "Cancelling a Print Job" on page 62.</p> <p>Set Paper</p> <p>The paper loaded in the specified paper source does not match the required paper size or type. Replace the loaded paper with the correct size paper or paper type, and press the OK button to resume printing. Pressing the OK button will print the rest of the print job on only one side of the paper. To cancel the print job, see "Cancelling a Print Job" on page 62. To clear this warning, make sure that A4 or LT is set to the specified paper source in the Tray Menu, load A4 or Letter size paper in the specified paper source and click the OK.</p> <p>Note: If A4/LT Auto Switching in Setup Menu is set to A4->LT, LT->A4 or A4<->LT:</p> <ul style="list-style-type: none"> <input type="checkbox"/> When printing a job specified as A4 with the printer driver, there is no paper source that is set as A4 or as LT (alternate size for A4) in the Tray Menu. <input type="checkbox"/> When printing a job specified as letter size with the printer driver, there is no paper source that is set as LT or as A4 (alternate size for LT) in the Tray Menu.
<input type="checkbox"/>	<input type="checkbox"/>	<input checked="" type="checkbox"/>	<input type="checkbox"/>	<input checked="" type="checkbox"/>	—	<p>Paper Out</p> <ul style="list-style-type: none"> <input type="checkbox"/> Paper is not loaded in the paper source from which the printer tried to feed. Loading paper clears the error and printing starts. <input type="checkbox"/> There is no paper loaded in any paper source. Loading paper into any paper source clears the error and printing starts. <input type="checkbox"/> Paper cassette is not inserted correctly. Push the cassette all the way in to securely insert it.
—	—		—	<input type="checkbox"/>	—	<p>Check Paper Size</p> <p>The paper size setting is different from the size of paper loaded in the printer. Check to see if the correct size of paper is loaded in the specified paper source.</p> <p>Check Media Type</p> <p>The paper loaded in the printer does not match the paper type setting in the printer driver. Paper that matches only the paper size setting will be used for printing.</p>







Troubleshooting

					Data	Statuses and handling methods (status monitor messages in bold)
					—	<p>There is not enough memory in the printer.</p> <p>Print Overrun</p> <p>The required time to process the print data exceeded the print engine speed because the current page is too complex. Press the OK button to resume printing, or cancel the print job. To cancel the print job, see “Cancelling a Print Job” on page 62.</p> <p>Memory Overflow</p> <p>The printer has insufficient memory to execute the current task. Press the OK button on the control panel to resume printing, or cancel the print job. To cancel the print job, see “Cancelling a Print Job” on page 62.</p> <p>Duplex Memory Overflow</p> <p>There is not enough memory for duplex printing. The printer prints only on the front and ejects the paper. Press the OK button to print on the back of the next sheet, or cancel the print job. To cancel the print job, see “Cancelling a Print Job” on page 62.</p> <p>Invalid Data</p> <p>The spool file on the driver is deleted while printing or the data is abnormal. Press the OK button to clear the error and skip the page on which the error occurred. If there is a printable page, restart printing from there. To cancel the print job, see “Cancelling a Print Job” on page 62.</p>
						<p>Unable Clear Error</p> <p>The printer cannot clear an error message because the error status still remains. Try solving the problem again.</p>
						<p>FORMATTING</p> <p>Formatting (initializing). Please wait.</p>
						<p>ROM CHECK</p> <p>The printer is checking the ROM. Please wait.</p>
						<p>RAM CHECK</p> <p>The printer is checking the RAM. Please wait.</p>
						<p>SELF TEST</p> <p>The printer is currently performing a self test and initialization. Please wait.</p>
						<p>Reset All</p> <p>All printer's interface has been reset and the buffer has been cleared. The printer reboots automatically. Please wait.</p>
				—	—	<p>Cancelling All Job</p> <p>The printer is canceling all print jobs in the printer memory, including jobs the printer is currently receiving or printing. Please wait.</p>
				—	—	<p>Cancelling Job</p> <p>The printer is canceling the specified print job and the current print job. Please wait.</p>
—	—	—		—	—	<p>Please wait</p> <p>Please wait. Do not turn off the power to the printer or open and close the cover.</p>

Troubleshooting

						Statuses and handling methods (status monitor messages in bold)
						<p>F/W Update Firmware is being updated. Do not turn off the power until the update is complete.</p> <p>Filling Toner Wait for the toner to fill.</p>
—	—	—	—			<p>Form Feed The printer is ejecting paper due to a user request.</p> <p>Printing Configuration Status Sheet Printing Supplies Status Sheet Printing Usage History Status Sheet ESC/Page Font Sample PCL Font Sample ESC/P2 Font Sample FX Font Sample I239 Font Sample PS3 Font List The corresponding sheet is printed.</p> <p>Screen25 Screen50 Screen100 A pattern is printed to check for uneven printing at the specified density (25%, 50%, or 100%).</p>
—	—	—		—	—	<p>Warming Up The printer is warming up the fuser to be ready to print.</p> <p>Adjusting Printer Wait a few minutes. Do not open or close the covers, or turn off the printer until this message disappears.</p> <p>Canceling Job The printer is canceling the specified print job and the current print job. Please wait.</p>
						<p>Sleep The printer is currently in the power-save mode. This mode is canceled when the printer receives print data or any key on the control panel is pressed.</p>
—	—	—		—	—	<p>Cooling Down The printer is cooling down. This is not an error message, and will clear itself.</p>
—	—	—			—	<p>Ready The printer is ready to receive data and print.</p>

Troubleshooting

					Data	Statuses and handling methods (status monitor messages in bold)
	—	—	—	<input type="checkbox"/>	—	Reboot to apply settings A setting item that is not enabled unless the printer is restarted has been changed. Turn the printer on and off, or do a reset all.
						Can't Print The print data is deleted because it is incorrect. Make sure the appropriate paper size and printer driver are used.
						Collate Disabled The print data is deleted because it is incorrect. Make sure the appropriate paper size and printer driver are used.
						Printing by specifying the number of copies is no longer possible due to a lack of memory (RAM). If this warning appears, print only one copy at a time.
						Image Optimum There is insufficient memory to print the page at the specified print quality. The printer automatically lowers the print quality so that it can continue printing. If the quality of the printout is not acceptable, try simplifying the page by limiting the number of graphics or reducing the number and size of fonts.
Need Memory The printer has insufficient memory to complete the current print job. To prevent this problem from recurring, reduce the resolution of the image to be printed.						
<input checked="" type="checkbox"/>	<input checked="" type="checkbox"/>	<input checked="" type="checkbox"/>	<input checked="" type="checkbox"/>	<input checked="" type="checkbox"/>	<input checked="" type="checkbox"/>	Service Req A controller error or a print engine error has been detected. Turn off the printer. Wait at least a few seconds, then turn it back on. If the error still appears, write down the error number listed on the status monitor (Cffff/Exxx), turn off the printer, unplug the power plug, and then contact a qualified service representative.
<input type="checkbox"/>	<input checked="" type="checkbox"/>	<input checked="" type="checkbox"/>	<input checked="" type="checkbox"/>	<input checked="" type="checkbox"/>	<input checked="" type="checkbox"/>	
<input checked="" type="checkbox"/>	<input checked="" type="checkbox"/>	<input checked="" type="checkbox"/>	<input type="checkbox"/>	<input checked="" type="checkbox"/>	—	F/W Update: Error The firmware update failed. Turn the power off and on, and then try to update again.
<input type="checkbox"/>	<input type="checkbox"/>	<input type="checkbox"/>		<input checked="" type="checkbox"/>	<input checked="" type="checkbox"/>	Recovery Mode Because the firmware update failed, the printer started in recovery mode. Use the steps below to try to update the firmware again.

Troubleshooting

Printing a Status Sheet

To confirm the current status and settings of the printer are suitable for your purpose, print the appropriate status sheet. The following table describes the major status sheets that can be printed from the control panel of your printer.

Note:

There are other printable sheets besides the sheets listed in the table below. See **System Report** menu in “[System Information](#)” on page 19 for more information.

Print Configuration Status Sheet*	Prints the configuration of the hardware and the settings of the control panel menus.
Print Supplies Status Sheet*	Prints the remaining service life of replacement parts and the remaining level of consumables in the printer.
Print Usage History Sheet*	Prints various statistics about the numbers of printouts, such as Paper Size or Paper Path.
Network Status Sheet	Prints the status of the network interface configuration.

* The printer driver can also print status sheets. Access the printer driver's **Maintenance** tab, and click the **Print Status Sheets** icon.

Printing from the control panel (For AL-M320DN/310DN)

Follow the steps below to print and confirm the **Configuration Status Sheet** from the control panel, as an example.

- 1 Turn on the printer. The LCD panel shows **Ready**.
- 2 Press the **▶ Right** button to access the control panel menus.

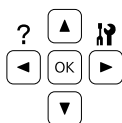

- 3 Use the **▼ Down** button to select **System Information**, then press the **▶ Right** button.

- 4 Use the **▼ Down** button to select **System Report**, then press the **▶ Right** button.
- 5 Use the **▼ Down** button to select **Print Configuration Status Sheet**, then press the **▶ Right** button.
- 6 Confirm that the information about the installed options is correct. If the options are installed correctly, they appear under **Hardware Configuration**. If the options are not listed, try reinstalling them.

Printing from the control panel (For AL-M220DN)

See “[Control Panel for AL-M220DN](#)” on page 15.

Note:

- If the configuration status sheet does not list your installed options correctly, make sure that they are securely connected to the printer.
- If you are unable to get the printer to print a correct configuration status sheet, contact your dealer.
- Print the configuration status sheet on A4 size paper.

Clearing Jammed Paper

If paper becomes jammed in the printer, the printer's LCD panel (AL-M320DN/AL-M310DN), LED lights (AL-M220DN), and EPSON Status Monitor provide alert messages. Paper jams may occur in more than one location simultaneously. For example, for AL-M320DN/AL-M310DN and when the LCD panel displays a message, such as **Clear Paper Jam C1 DM**, clear the jams in the order they are displayed.

Be sure to observe the following points when you clear jammed paper.

- Do not remove jammed paper by force. Torn paper can be difficult to remove and might cause other paper jams. Pull the paper gently and steadily with both hands to avoid tearing it, falling down, and injuring yourself.

Troubleshooting

- ❑ If jammed paper is torn and remains in the printer, or if paper is jammed in a place not mentioned in this section, contact your dealer.
- ❑ Make sure that the paper type that is loaded is the same as the Paper Type setting in the printer driver.
- ❑ If paper jams occur repeatedly, check that the printer's setup is correct, and that the settings on the printer are correct. See [“Paper Does Not Feed Properly”](#) on page 90 for more information.

⚠ Caution:

- ❑ When you open the printer's covers F1, F2, or E while doing these operations, do not touch the areas indicated by the warning labels. High temperatures may cause burns.

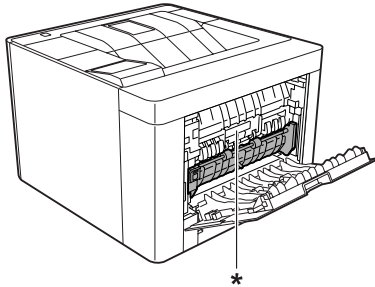

* caution label

⚠ Caution:

- ❑ Be careful of the covers opening and closing quickly. There is a risk of pinching your fingers and being injured.

Inside

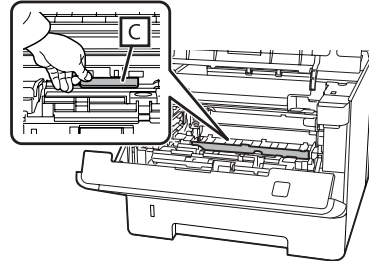

Inside the front

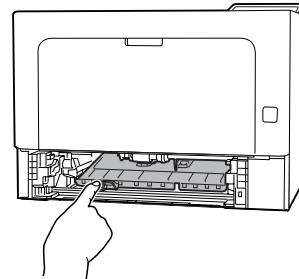

Back

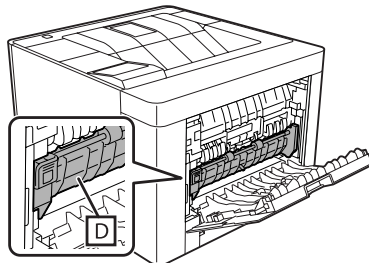

F (Cover F)

- 1 Remove all paper from the MP tray and close it.

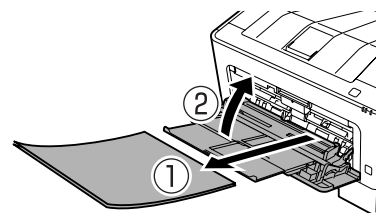

Troubleshooting

- 2** Press the button on the top, then open covers F1 and F2.

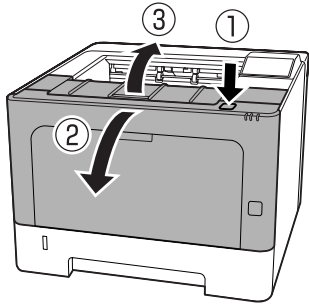

- 3** Press lever A on left side.

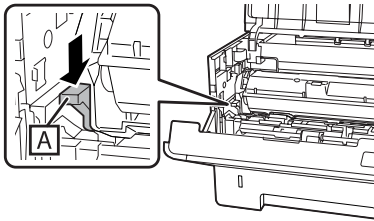

- 4** Remove the maintenance unit A.

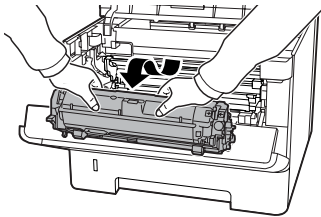

- 5** Remove the maintenance unit B while holding section B.

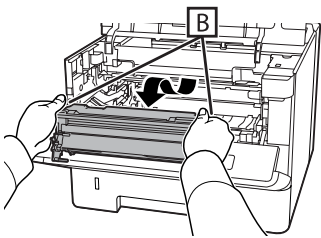

! **Important:**

- ❑ Do not expose maintenance unit B to light for a long period of time.
- ❑ To avoid damaging it, do not touch the photoconductor (drum) in maintenance unit B.

- 6** While holding up inside cover C, remove any sheets of paper.

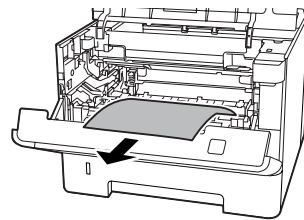
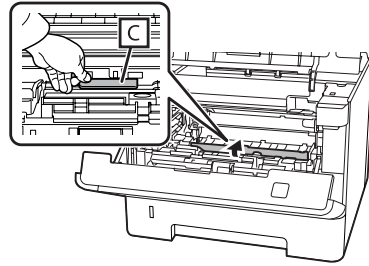

- 7** Insert the maintenance unit B.

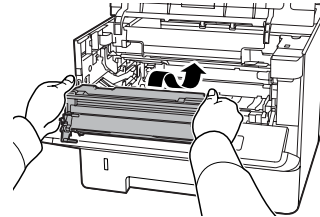

- 8** Insert the maintenance unit A.

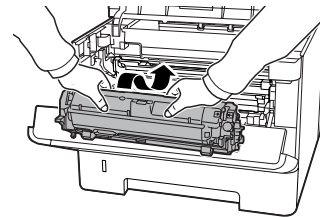

- 9** Close covers F1 and F2.

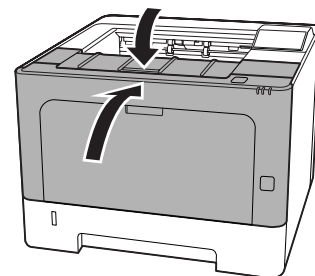

Troubleshooting

E (Cover E)

- 1** Open cover E at the back.

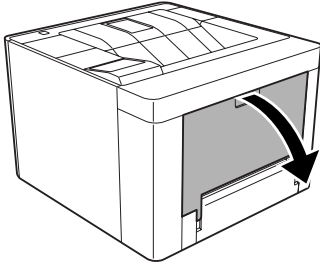

- 2** Remove any sheet of paper.

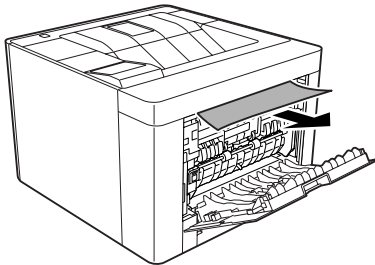

If you cannot pull the paper out from the upper part, go to step 3.

- 3** While opening section D, remove any sheets of paper.

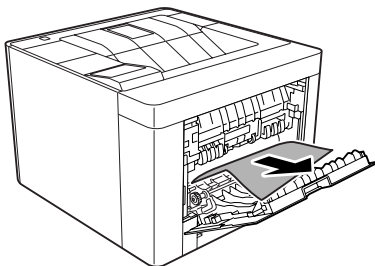
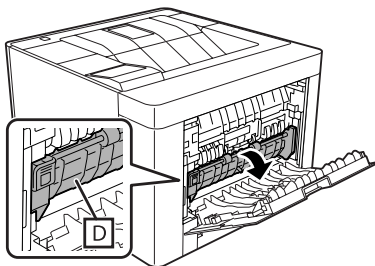

- 4** Close cover E at the back.

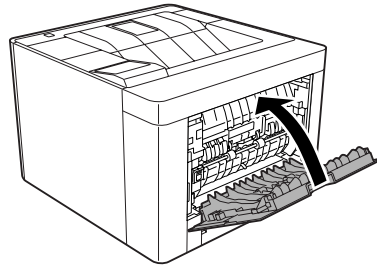

- 5** Press the button on the top, open and close cover F1, then close cover F2.

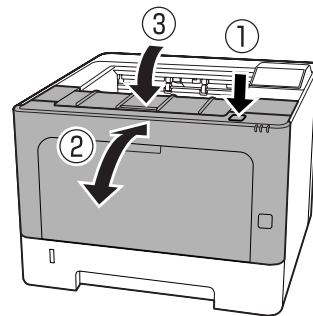

Troubleshooting

C1 DM (Cassette1/DM knob)

1 Remove the paper cassette.

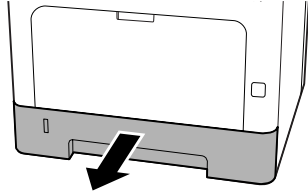

2 Lower the inside cover with your finger on the blue knob.

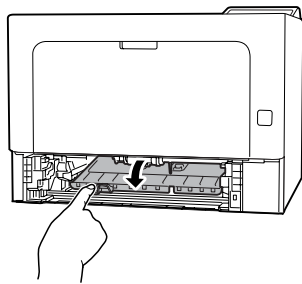

3 Remove any sheets of paper.

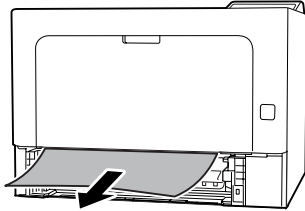

4 Place your finger on the blue knob and firmly raise the inside cover.

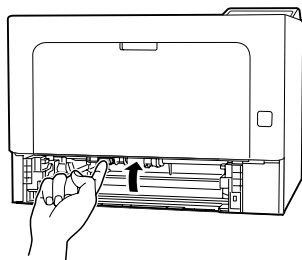

5 Insert the paper cassette.

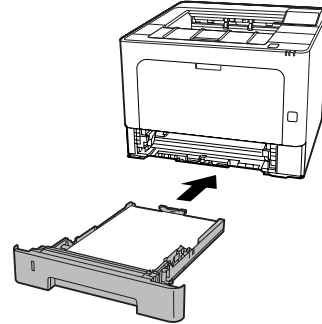

6 Press the button on the top, open and close cover F1, then close cover F2.

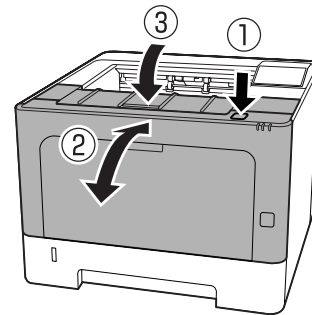

MP (MP tray)

1 Remove any sheets of paper.

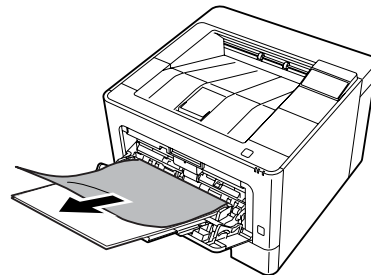

2 Remove all paper from MP tray and reload.

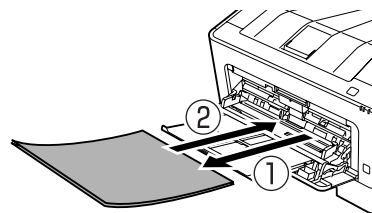

Troubleshooting

- 3** Confirm that the paper size and the orientation match the settings in the control panel (for AL-M320DN/AL-M310DN), in **EpsonNet Config** on your web browser, or in Printer Settings in the printer driver (for AL-M220DN).

C1 - C3 (Cassette 1 - 3)

For AL-M320DN/AL-M310DN, these instructions use the standard paper cassette (C1) as an example. Use the same procedure for optional paper cassettes C2 and C3.

- 1** Remove the paper cassette.

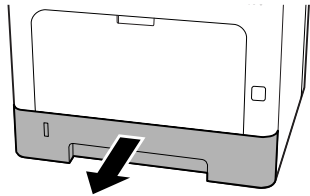

- 2** Remove any sheets of paper.

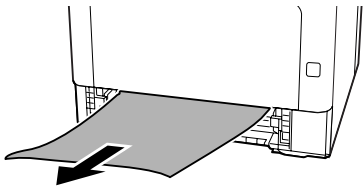

- 3** Insert the paper cassette.

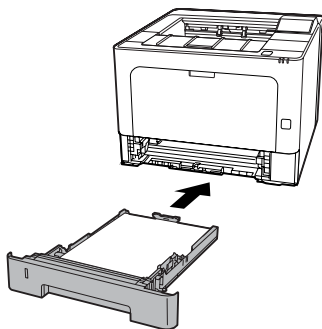

- 4** Press the button on the top, open and close cover F1, then close cover F2.

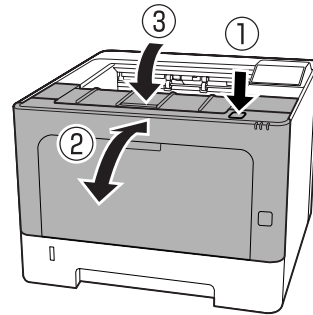

- 5** Confirm that the paper size and the orientation match the settings in the control panel (for AL-M320DN/AL-M310DN), in **EpsonNet Config** on your web browser, or in Printer Settings in the printer driver (for AL-M220DN).

Troubleshooting

Paper Does Not Feed Properly

Cause	What to do
The paper guides are not set correctly.	Make sure that the paper guides in all the paper cassettes and the MP tray are set to the correct paper size positions. Do not move the paper guide after the paper is loaded.
The paper source setting may not be correct.	Make sure that you have selected the correct paper source in your application.
There may be no paper in the paper source.	Load paper into the selected paper source.
The size of loaded paper differs from the control panel or printer driver settings.	Make sure that the correct paper size and paper source are set in the control panel or printer driver.
The printer may have loaded more than one sheet at a time.	Remove the paper stack and fan it. Tap it on a flat surface to even the edges, then reload the paper.
Too many sheets may be loaded in the MP tray or paper cassettes.	Make sure that you have not tried to load too many sheets of paper. For the maximum paper capacity for each paper source, see "Available Paper and Capacities" on page 40.
If paper does not feed from the optional paper cassette unit, the unit may not be installed properly.	For instructions on installing the unit, see "Optional paper cassette unit" on page 101.
If paper does not feed from the optional paper cassette unit, it may be because the printer driver does not recognize the optional paper cassette unit.	Access the Optional Settings tab in the printer driver and do one of the following: <ul style="list-style-type: none"> <input type="checkbox"/> Select the Acquire from Printer check box and click Get to automatically update the installed option information. <input type="checkbox"/> Select the Manual Settings check box and click Settings to do the settings for each installed option.

Power and Control Panel Problems

The ready light does not turn on

Cause	What to do
The power cord may not be properly plugged into the electrical outlet.	Turn off the printer, check the power cord connections between the printer and the electrical outlet, then turn the printer back on.

Troubleshooting

Cause	What to do
The printer is in the sleep mode or deep sleep mode.	<p>Check if your printer is in sleep mode. See "Using Sleep Mode to Save Energy" on page 59.</p> <p>The printer recovers from the sleep mode or the deep sleep mode in the following cases:</p> <ul style="list-style-type: none"> - When the printer receives a print job - For AL-M320DN/AL-M310DN, when the Wakeup/Sleep button is pressed - For AL-M220DN, when any button on the control panel is pressed <p>Note: <i>With AL-M320DN and AL-M310DN, the sleep status can also be shown by a flashing Ready light. This makes the status easier to notice.</i></p> <p>See 17 ShowSleepByRdyLamp in "Support Menu" on page 106.</p>
The printer is in the power off mode (the Wakeup/Sleep button blinks for AL-M320DN/AL-M310DN or all lights are off for AL-M220DN).	<p>Turn on the printer by pressing the power switch. For AL-M320DN/AL-M310DN, pressing the Wakeup/Sleep button also makes the printer available for printing.</p> <p>To not enter the power off mode, access Energy Saver Menu, and set both Power Off if Inactive and Power Off If Disconnected to Off.</p>

The printer turns off automatically

Cause	What to do
The printer is in the power off mode (the Wakeup/Sleep button lights for AL-M320DN/AL-M310DN or all lights are off for AL-M220DN).	To not enter the power off mode, access Energy Saver Menu, and set both Power Off if Inactive and Power Off If Disconnected to Off.

The Printer does not turn off

Cause	What to do
The printer is in the power off mode (the Wakeup/Sleep button lights for AL-M320DN/AL-M310DN or all lights are off for AL-M220DN).	Wait for a while. The printer turns off in approximately ten seconds.
The power switch is pressed while the printer is in deep sleep mode.	<p>Wait for a while. The printer turns off in approximately ten seconds.</p> <p>Note: <i>With AL-M320DN and AL-M310DN, the sleep status can also be shown by a flashing Ready light. This makes the status easier to notice.</i></p> <p>See 17 ShowSleepByRdyLamp in "Support Menu" on page 106.</p>

Troubleshooting

The Printer Does Not Print

Ready light is off

Cause	What to do
The printer is offline.	Press the Pause/Release button (for AL-M320DN/AL-M220DN), or press the OK button (for AL-M220DN), once to switch the printer to a ready status. Make sure that the Ready light turns on.
Some error may have occurred.	For AL-M320DN/AL-M310DN, if an error message appears, see "Status and Error Messages on the Control Panel (for AL-M320DN/AL-M310DN)" on page 72. For AL-M310DN, if an error light is on or flashing, see "Status and Error Lights (for AL-M220DN)" on page 78.
The power cord may not be properly plugged into the electrical outlet.	Turn off the printer, check the power cord connections between the printer and the electrical outlet, then turn the printer back on.
The printer is in the power off mode (All lights go out).	Turn on the printer by pressing the power switch. For AL-M320DN/AL-M310DN, pressing the WakeUp/Sleep button also makes the printer available for printing. To not enter the power off mode, access <code>Energy Saver Menu</code> , and set both <code>Power Off if Inactive</code> and <code>Power Off If Disconnected</code> to Off.

The ready light is on

Cause	What to do
The printer is paused or offline (Windows)	If you stop printing or the printer stops printing because of some error, the printer or status of the print manager changes to Pause Printing. You cannot print in this status. 1. Click Start - Devices and Printers. 2. Select the icon for the printer and open the Printer menu from the Print Jobs display. Clear the checks from Pause Printing and Use Printer Offline.
The interface cable may not be plugged in securely.	Check both ends of the interface cable between the printer and the computer.
You may not be using the correct interface cable.	Use a cable that matches the specifications of the printer. Confirm that there are not breaks in the cable. If you are using the USB interface, use a cable that is compatible with Hi-Speed USB.
Your application software is not properly set up for your printer.	Make sure that the printer is selected in your application software.
Your computer system's memory is too small to handle the volume of data in your document.	Try reducing the image resolution of your document in the application software, or install more memory in your computer if you can.

Troubleshooting

Printout Problems

Print quality is poor

Refer to the table below if your printouts are light, faint, uneven, dark, or dirty or if some areas are not printed.

Cause	What to do
You may not be using the correct type of paper for your printer.	Smooth, high-quality copier paper is recommended for best results. See "Available Paper and Capacities" on page 40 for information on choosing paper.
Your paper may be moist or damp.	Do not store your paper in a humid or damp environment.
The paper type setting may not be appropriate for the loaded paper.	Set the appropriate paper type in the printer driver.
The Toner Save mode may be on.	Turn off the toner save mode using the printer driver, the printer's control panel or EpsonNet Config on your web browser. For Windows users, on the More Options tab in the printer driver, click Image Options and select the Toner Save check box.
The paper path inside the printer may be dusty.	Clean internal printer components by printing three pages with only one character per page. If the printouts get dirty, clean the paper feed roller. See "Cleaning the inner roller" on page 70 .
The voltage for the main charger is not correct. (AL-M320DN/AL-M310DN)	Changing the voltage for the main charger also changes the print density. You can change the voltage from Main Charger in the Printer Adjust Menu.
The Highland setting may not be set correctly for printing in a location at a high altitude.	Select the appropriate value in Highland of the Printer Adjust Menu. See "Printer Adjust Menu" on page 106 .
There may be a problem with the toner cartridge, or the toner cartridge has come to near the end of its service life.	Print several pages to check if the quality of the printouts has improved. If it has not improved, replace the toner cartridge with new one. For information about replacing parts, see the instructions that come with each replacement parts.
Condensation may occur.	Wait at least one hour before using the printer after moving it from a cool to a warm environment. Try refreshing the drum. See "Printer Adjust Menu" on page 106 .
The printer cannot print in the required quality level because of insufficient memory, and the printer lowers the quality automatically so that the printer can continue printing.	Check to see if the printout is acceptable. If not, lower print quality temporarily in the printer driver. For AL-M320DN/AL-M310DN, if RAM Disk is set to Maximum or Normal on the control panel, you can increase the available memory space by changing this setting to Off.

Cannot Read Barcode

Cause	What to do
The Quality setting in the printer driver is set to Fast (300 dpi).	Click Fine (600 dpi) or More Settings, increase the priority level for quality, and then print.

Troubleshooting

Cause	What to do
The Emphasize Text setting in the printer driver is set to Emphasize or Emphasize More.	Set Emphasize Text to Off in Image Options on the More Options tab, and then print.

Note:

Turn the Barcode mode to Mode 1 or Mode 2 in Extended Settings on the Maintenance tab, and then try printing. This setting prints sharply defined barcodes. For the fastest barcode printing, use Mode 1. For the best barcode quality, use Mode 2.

Set the mode to Off when you have finished printing barcodes.

The printout is not what you expected

Some part of the graphics or text looks different from what you see on the computer screen

Cause	What to do
The printer emulation setting in your application may be incorrect.	Make sure that your application is set for the printer emulation you are using. For example, if you are using the ESC/Page mode, make sure that your application is set to use an ESC/Page printer.

The printout position is not correct

Cause	What to do
The page length and margins may be set incorrectly in your application.	Make sure that you are using the correct page length and margin settings in your application.
The paper size setting may be incorrect.	Make sure the correct paper size is set in the Tray Menu using the printer's control panel, EpsonNet Config on your web browser, or the Printer Settings in the printer driver.
The offset values may be changed in the Printer Adjust Menu.	Confirm and adjust the offset values such as Feed Offset or Scan Offset. See " Printer Adjust Menu " on page 106 for details.
The paper guide was touched after the paper was loaded.	Touching the paper guide after the paper is loaded may cause the guide to become misaligned. Refer to " Loading Paper " on page 44 for how to load the paper.

Cannot print all copies

Cause	What to do
The printer does not have sufficient memory to collate print jobs.	Reduce the contents of print jobs, or increase the available memory on your printer. For AL-M320DN/AL-M310DN, if RAM Disk is set to Maximum or Normal on the control panel, you can increase the available memory space by changing this setting to Off.

Troubleshooting

The last page of a two-sided printout is printed on the wrong side of the paper

Cause	What to do
Convert to Simplex is set to Odd Page or 1 Page.	For jobs with three or more pages, set Convert to Simplex to Off or 1 Page to do duplex printing. For jobs with just one page, set Convert to Simplex to Off to do duplex printing. See "Setup Menu" on page 21 .

Printout is garbled

Cause	What to do
The interface cable may not be plugged in securely.	Make sure that both ends of the interface cable are plugged in securely.
You may not be using the correct interface cable.	Use a cable that matches the specifications of the printer. Confirm that there are not breaks in the cable. If you are using the USB interface, use a cable that is compatible with Hi-Speed USB.
The emulation setting for the port may not be correct.	Specify the emulation mode by make sure the correct paper size is set in the Tray Menu using the printer's control panel EpsonNet Config on your web browser, or the Printer Settings in the printer driver. See "Emulation Menu" on page 31 .

Note:

If a configuration status sheet does not print correctly, your printer may be damaged. Contact your dealer or a qualified service representative.

The font cannot be printed

Cause	What to do
For Windows users, you may use the printer fonts substituted for specified TrueType fonts.	In the printer driver, choose the Print TrueType fonts as bitmap check box in the Extended Settings dialog box.
The selected font is not supported by your printer.	Make sure that you have installed the correct font. See the <i>Font Guide</i> for more information.
The Mode is in Low Speed Mode. The Barcode Mode is in Mode 2.	This mode is for printing at low speed. Do the following in Extended Settings on the Maintenance tab. - Clear the check from Low Speed Mode - Turn Barcode Mode Off

Printing in the PS3 Mode Problems

The problems listed in this section are those that you may encounter when printing with the PostScript driver. All procedural instructions refer to the PostScript printer driver.

Troubleshooting

The printer does not print correctly in the PostScript mode

Cause	What to do
The printer's emulation mode setting is incorrect.	The printer is set to the <code>Auto</code> mode by default, so that it can automatically determine the encoding used in the received print job data and select the appropriate emulation mode. However, there are situations where the printer cannot select the correct emulation mode. In this case, it must be set manually to <code>PS3</code> . Set the emulation mode through the <code>SelectType Emulation Menu</code> on the printer. See " Emulation Menu " on page 31.
The printer's emulation mode setting for the interface that you are using is incorrect.	The emulation mode can be set individually for each interface which receives print job data. Set the emulation mode for the interface you are using to <code>PS3</code> . Set the emulation mode through the <code>SelectType Emulation Menu</code> on the printer. See " Emulation Menu " on page 31.

The printer does not print

Cause	What to do
An incorrect printer driver is selected.	Make sure that the PostScript printer driver that you are using to print is selected.
The <code>Emulation Menu</code> in the printer's Control Panel is set to a mode other than <code>Auto</code> or <code>PS3</code> for the interface that you are using.	Change the mode setting to either <code>Auto</code> or <code>PS3</code> .

The printer or its driver does not appear in utilities in the printer configuration (Mac OS only)

Cause	What to do
The printer name has been changed.	Ask the network administrator for details, then select the appropriate printer name.

The font on the printout is different from that on the screen

Cause	What to do
The PostScript screen fonts are not installed.	The PostScript screen fonts must be installed on the computer that you are using. Otherwise, the font that you select is substituted by some other font for display on the screen.
For Windows users only The appropriate substitution fonts are not correctly specified on the Device Settings tab of the printer's Properties dialog box.	Specify the appropriate substitution fonts using the Font Substitution Table.

Troubleshooting

The edges of texts and/or images are not smooth

Cause	What to do
The Print Quality is set to Fast .	Change the Print Quality setting to Fine .

The printer does not print normally via the USB interface

Cause	What to do
<p>For Windows users only</p> <p>The Data Format setting in the printer's Properties is not set to ASCII or TBCP.</p>	<p>The printer cannot print binary data when it is connected to the computer via the USB interface. Make sure that the Data Format setting, which is accessed by clicking Advanced on the PostScript sheet of the printer's Properties, is set to ASCII or TBCP.</p> <p>If your computer is running Windows Vista, Vista x64, XP, XP x64, click the Device Settings tab in the printer's Properties, then click the Output Protocol setting and select ASCII or TBCP.</p>
<p>For Mac OS users only</p> <p>The print setting in the application is set to binary encoding.</p>	<p>The printer cannot print binary data when it is connected to the computer via the USB interface. Make sure that the print setting in the application is set to ASCII encoding.</p>

The printer does not print normally via the network interface

Cause	What to do
<p>For Windows users only</p> <p>The Data Format setting is different from the data format setting specified in the application.</p>	<p>If the file is created in an application that allows you to change the data format or encoding, such as Photoshop, make sure that the setting in the application matches that in the printer driver.</p>
<p>For Windows users only</p> <p>The print data is too large.</p>	<p>Click Advanced on the PostScript sheet of the printer's Properties, then change the Data Format setting from ASCII data (default) to TBCP (Tagged binary communications protocol).</p> <p>When the Binary setting is set to On, TBCP is not available. Use the Binary protocol. See "PS3 Menu" on page 32 for details.</p>
<p>For Windows users only</p> <p>Printing cannot be performed using the network interface.</p>	<p>Click Advanced on the PostScript sheet of the printer's Properties, then change the Data Format setting from ASCII data (default) to TBCP (Tagged binary communications protocol).</p> <p>When the Binary setting is set to On, TBCP is not available. Use the Binary protocol. See "PS3 Menu" on page 32 for details.</p>

An undefined error occurs (Mac OS only)

Cause	What to do
The version of the Mac OS that you are using is unsupported.	This printer's driver can only be used on Mac OS computers running Mac OS X version 10.6.8 or later.

Troubleshooting

Other Problems

The optional product is not available

Cause	What to do
The printer does not recognize the optional product.	Print a configuration status sheet to see if the printer recognizes the optional product. If not, reinstall the optional product.
The setting for recognizing options may be set manually.	<p>Access the Optional Settings tab in the printer driver and do one of the following:</p> <ul style="list-style-type: none"> <input type="checkbox"/> Select the Acquire from Printer check box and click Get to automatically update the installed option information. <input type="checkbox"/> Select the Manual Settings check box and click Settings to do the settings for each installed option.

Correcting USB problems

Cause	What to do
The printer is connected through one or more USB hubs.	For best results, you should connect the printer directly to the computer's USB port. If you must use multiple USB hubs, we recommend that you connect the printer to the first tier of a certified hub.
Microsoft's universal driver is installed. To check if the universal driver has been installed, see the note below.	Reinstall the printer software as described in the <i>Setup Guide</i> .

Note:

To check if the Universal driver has been installed, follow the steps below.

- 1 Open **Devices and Printers**. Then right-click the icon for your printer.
- 2 Click **Printing Preferences** on the menu that appears, then right-click anywhere in the driver.
- 3 If **About** is displayed, click it.
- 4 If a message box with the words "Unidrv Printer Driver" appears, the software has not been installed correctly. Note that if **About** is not displayed, the printer software has been installed correctly.

For Windows Vista, Windows XP, or Windows Server 2003, if the software installation dialog box appears during the installation process, click **Continue Anyway**. If you click **STOP Installation**, you will have to install the printer software again.

Troubleshooting

Cannot access the shared printer

Cause	What to do
Inappropriate texts are used for the Share name of the shared printer.	Do not use spaces or hyphens for the Share name.
An additional driver cannot be installed on the client computer, although the print server's OS and the client OS are different.	Install the printer drivers from the Software Disc.
Your network system causes this problem.	Ask the administrator of the network for assistance.

Note:

For the additional driver to be installed, please see the table below.

Server OS	Client OS	Additional Driver
Windows XP*	Windows XP clients	Intel Windows 2000 or XP
	Windows XP x64 clients	x64 Windows XP
Windows XP x64, Windows Server 2003, or Windows Server 2003 x64*	Windows XP clients	Windows XP and Windows Server 2003
	Windows XP x64 clients	x64 Windows XP and Windows Server 2003
Windows 10, Windows 8.1, Windows 8.1 x64, Windows 8, Windows 8 x64, Windows 7, Windows 7 x64, Windows Vista, Windows Vista x64, Windows Server 2016, Windows Server 2012/R2, Windows Server 2008, 2008 x64/R2	Windows 10, Windows 8.1, Windows 8, Windows 7, Windows Vista, or Windows XP clients	x86 Type 3 - User Mode
	Windows 10, Windows 8.1 x64, Windows 8 x64, Windows 7 x64, Windows Vista x64, or Windows XP x64 clients	x64 Type 3 - User Mode

* The additional driver for Windows XP x64 and Server 2003 x64 can be used on Windows XP Service Pack 3, Windows 2003 Service Pack 2, or later.

Troubleshooting

Transporting the Printer

For short distances

Before you move the printer, prepare the location where you are going to place it. See the following sections.

- ❑ “Setting up the printer” on page 7
- ❑ “Finding the place for the printer” on page 8

1 Make sure the printer is turned off and the operation panel is unlit, and then unplug the power plug from the outlet.

2 Remove the following items from the printer.

- ❑ Power cord
- ❑ Interface cables
- ❑ Loaded paper
- ❑ Installed options (For AL-M320DN/AL-M310DN)

3 Be sure to lift the printer by the correct positions as shown below.

Do not touch the projections on the bottom of the printer that are for connecting an optional paper cassette.

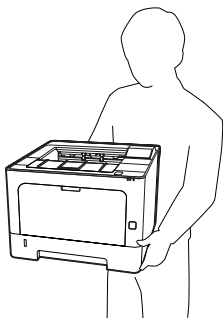

! **Important:**
When moving the printer, always keep it horizontal.

For long distances

Before you move the printer, prepare the location where you are going to place it. See the following sections.

- ❑ “Setting up the printer” on page 7
- ❑ “Finding the place for the printer” on page 8

Repacking the printer

If you need to transport your printer for long distances, carefully repack it using the original box and packing materials.

1 Make sure the printer is turned off and the operation panel is unlit, and then unplug the power plug from the outlet.

2 Remove the following items from the printer.

- ❑ Power cord
- ❑ Interface cables
- ❑ Loaded paper
- ❑ Installed options (For AL-M320DN/AL-M310DN)

3 Press the button on the top to open covers F1 and F2.

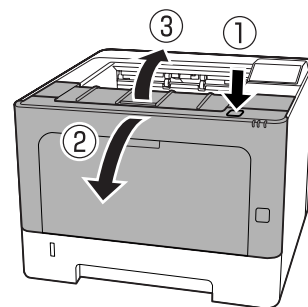

! **Important:**
Do not touch the inner rollers and gears. Doing so may cause malfunctions or deterioration in print quality.

Troubleshooting

- 4** Press down on lever A on the left side.

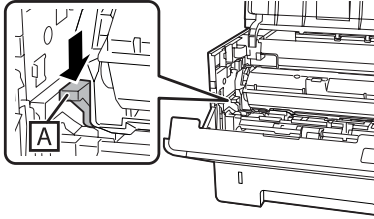

- 5** Remove maintenance unit A.

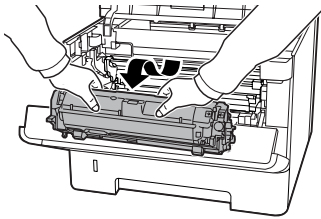

Put maintenance unit A in a plastic bag or wrap it in something like a thick cloth and put it in a packing carton.

! **Important:**

- Do not remove maintenance unit B.
- If you do not remove maintenance unit A before you move the printer, the toner may spill inside the printer.

- 6** Close covers F1 and F2.

- 7** Attach the protective materials onto the printer, then repack the printer in its original box.

! **Important:**

When moving the printer, always keep it horizontal.

Installing Options (AL-M320DN/ AL-M310DN)

Optional paper cassette unit

For details about the paper types and sizes that you can use with the optional paper cassette unit, see [“Available Paper and Capacities”](#) on page 40.

The available optional paper cassette units are as follows:

250-Sheet Paper Cassette Unit × 2

Handling precautions

Always pay attention to the following handling precautions before installing the option:

Be sure to lift the printer from the positions shown below.

Do not touch the projections on the bottom of the printer that are for connecting an optional paper cassette.

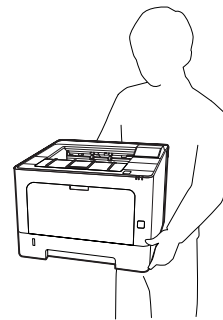

! **Caution:**

If you lift the printer incorrectly, you could drop it and cause injury.

Troubleshooting

Installing the optional paper cassette unit

- 1 Turn the printer off and unplug the power cord and interface cable.



Important:

Be sure to unplug the power cord from the printer to prevent getting an electric shock.

- 2 Carefully take the optional paper cassette unit out from its carton and place it where you intend to set up the printer.
- 3 Place another optional paper cassette unit or the printer onto the first optional paper cassette unit. Align each corner of the other optional paper cassette unit or printer with those of the first optional paper cassette unit. Then lower the other optional paper cassette unit or printer until it rests securely on the optional paper cassette unit.

Optional paper cassette unit

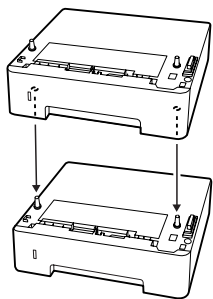

Printer

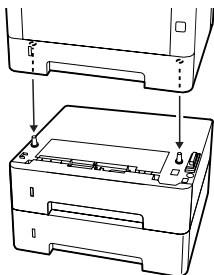

- 4 Reconnect the interface cable and power cord, and then turn the printer on.

To confirm that the option is installed correctly, print a configuration status sheet. See [“Printing a Status Sheet” on page 84](#).

Removing the optional paper cassette unit

Perform the installation procedure in reverse.

Appendix

Appendix

Technical Specifications

General

Item		AL-M320DN	AL-M310DN	AL-M220DN
Printing method		Laser beam scanning and dry electrophotographic process		
Resolution		600 × 600 dpi, 1200 × 1200 dpi		
Continuous printing speed on A4 size paper* ¹		40 ppm	35 ppm	30 ppm
Paper feed		Automatic or manual feed		
Paper feed alignment		Center alignment for all sizes		
Automatic 2-sided printing function		Standard		
Printer language		ESC/Page5 Printing system, ESC/Page ESC/P 2 24-pin printer emulation (ESC/P 2 mode) ESC/P 9-pin printer emulation (FX mode) IBM Proprinter emulation (I239X mode) PostScript compatible with PostScript Level 3 (PS3 mode) PCL6/PCL5 emulation (PCL mode) PDF 1.7		
Memory	RAM	1024MB	512MB	512MB
Interfaces	USB	Hi-Speed USB		
	Ethernet:	1000BASE-T/100BASE-TX/10BASE-Te		
Supported protocols		TCP/IP (IPv4, IPv6), LPR, Port9100, WSD, Bonjour, IPP/IPPS, HTTP/ HTTPS, SNMP, SMTP, LLTD, IPSec, 802.1X		
Resident fonts		84 scalable fonts, and 7 bitmap fonts for ESC/Page 95 scalable fonts, and 5 bitmap for PCL5 80 scalable fonts, and 1 bitmap for PCL6 80 scalable fonts for PostScript3 compatible with PostScript Level 3 10 typeface for ESC/P2 8 typeface for FX 8 typeface for I239		

Appendix

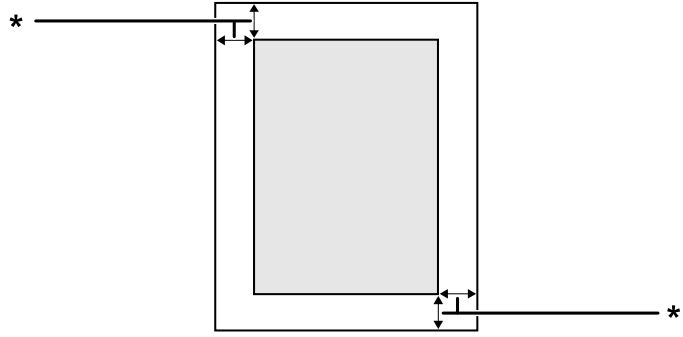
Item		AL-M320DN	AL-M310DN	AL-M220DN
Printable area		The assured printable area is an area 4 mm from all sides.		
		 <p>* 4 mm</p>		
		Note: The printable area may be smaller depending on the application.		
Dimensions (Width × Depth × Height)	Printer ^{*2*} ^{*3*} ^{*4}	375 (W) × 393 (D) × 285 (H) mm (14.8 × 15.5 × 11.2 in.)	375 (W) × 393 (D) × 265 (H) mm (14.8 × 15.5 × 10.4 in.)	
	Optional paper cassette unit ^{*2*} ^{*4}	375 (W) × 393 (D) × 100 (H) mm (14.8 × 15.5 × 11.2 in.)	-	
Weight	Printer ^{*5}	Approx. 14 kg (about 30.9 lb)		
	Optional paper cassette unit	Approx. 2.9 kg (about 6.4 lb)		
Operating environment	Temperature	10 to 32.5°C (50 to 89.6°F)		
	Humidity	15 to 80 %RH		
	Altitude (Air pressure) ^{*6}	0 to 3,500 meters		
Storage environment	Temperature	0 to 35°C (32 to 95°F),		
	Humidity	15 to 85 %RH		
	Altitude (Air pressure)	0 to 3,500 meters (0 to 15,000 in transport)		

^{*1} Depending on the paper type or size, such as printing on paper smaller than A4, the print speed may become slower. The abbreviation "ppm" means "pages per minute".

^{*2} Figures in mm are rounded off to the nearest whole number.

^{*3} MP tray closed.

^{*4} Excluding protrusions.

^{*5} Excluding consumable products and options.

^{*6} For high altitude locations, the printer's Highland setting in the Printer Adjust Menu must be adjusted according to the altitude at which the printer is located. See "Printer Adjust Menu" on page 106 for details.

Appendix

Electrical

			AL-M320DN		AL-M310DN		AL-M220DN
Rated voltage			110 V	220-240 V	110 V	220-240 V	110 V
Rated frequency			50 Hz/60 Hz	50 Hz/60 Hz	50 Hz/60 Hz	50 Hz/60 Hz	50 Hz/60 Hz
Rated current			8.8 A	4.2 A	8.8 A	4.2 A	8.8 A
Power consumption	During printing	MAX	930 W	870 W	940 W	880 W	940 W
		Average	624 W	609 W	569 W	594 W	517 W
	In sleep mode*		2.78 W	2.36 W	2.78 W	2.33 W	2.48 W
	In deep sleep mode		0.87 W	0.87 W	0.86 W	0.87 W	0.92 W
	In ready mode		7 W	7 W	7 W	7 W	7 W
	In power off mode		0.05 W	0.05 W	0.05 W	0.05 W	0.05 W
	Power off		0.05 W	0.05 W	0.05 W	0.05 W	0.05 W

* Values represent power consumption while all operations are completely suspended. Power consumption varies depending on operating conditions.

Note for users in Europe:

See the following Website for details on power consumption.

<http://www.epson.eu/energy-consumption/>

Note for users in Taiwan:

Rated voltage of this printer in Taiwan is 110 V.

Supported operating systems

Windows 10 (32-bit, 64-bit)/Windows 8.1 (32-bit, 64-bit)/Windows 8 (32-bit, 64-bit)/Windows 7 (32-bit, 64-bit)/Windows Vista (32-bit, 64-bit)/Windows XP SP3 or higher (32-bit), Windows XP Professional x64 Edition SP2 or higher/Windows Server 2016/Windows Server 2012 R2/Windows Server 2012/Windows Server 2008 R2/Windows Server 2008/Windows Server 2003 R2/Windows Server 2003 SP2 or higher

Mac OS X v10.6.8 - v10.11.x, macOS 10.12

Support Mode Settings using the control panel



Important:

Remove interface cables before you enter the SUPPORT MODE.

Appendix

Support Menu

You can make special settings by using the control panel. Normally you do not need to change the settings.

For AL-M320DN/AL-M310DN:

Pressing the ▼ **Down** button while turning the printer on, opens the SUPPORT MODE. Press the ► **Right** button, select **Common Settings** by pressing the ▲ **Up** or ▼ **Down** button, then select the **Support Menu**.

For AL-M220DN:

While pressing Alt, Ctrl and Z at the same time, click the **Extended Settings** button. The Support Menu appears.

Item	Explanation
1 Support StatusSheet	Prints a sheet showing information about settings of Support Menu and Printer Adjust Menu.
7 Extend Print Area*	On enlarges the maximum print area according to the printed data.
9 Printer MIBv1 Mode	On uses MIBv1 as a policy rule definition reporting the printer information to the SNMP manager.
10 USB ID	Printers of the same model that are set to Common are recognized as the same device on the computer because they are using a common USB device ID. The plug and play screen is not displayed even if you switch the printer for a different printer that is the same model. Settings (default in bold): Unique , Common
11 MP Size Setting 12 C1 Size Setting 13 C2 Size Setting* 14 C3 Size Setting*	Prints on the paper size specified in the Tray Menu. Paper sizes that were specified for the print job from the printer driver are ignored.
17 ShowSleepByRdyLamp*	The Ready light flashes when in sleep mode. Turning this to On is useful when the printer is installed in a place where it is difficult to see that the sleep mode light is lit.

* AL-M320DN/AL-M310DN only

Printer Adjust Menu

You can make special settings by using the control panel. Normally you do not need to change the settings.

For AL-M320DN/AL-M310DN:

Pressing the ▼ **Down** button while turning the printer on, opens the SUPPORT MODE. Press the ► **Right** button, select **Common Settings** by pressing the ▲ **Up** or ▼ **Down** button, then select the **Printer Adjust Menu**.

For AL-M220DN:

While pressing Alt, Ctrl and Z at the same time, click the **Extended Settings** button. The Printer Adjust Menu appears.

Note:

The settings in this menu may affect the remaining service lives of consumable products.

Appendix

Item	Explanation
001 Plain	<p>Adjusts the print quality for plain paper according to paper type.</p> <p>Settings (default in bold):</p> <p>1: Plain paper 2: Semi-thick paper</p>
020 Special	<p>Adjusts the print quality for special paper according to the paper type.</p> <p>Settings (default in bold):</p> <p>0: Thin paper 1: Plain paper 2: Semi-thick paper 3: Letterhead 4: Thick paper 5: Extra-thick paper 6: Super-thick paper 7: When printing graph patterns, etc., on paper that is damp or paper that has been left out for a long time 8: When printing graph patterns, etc., on paper that is even damper or paper that has been left out for an even longer time than in 7 9: When you want to reduce the effects that hole punches have on images 10: When you want to reduce the effects that hole punches have on images even more than in 9</p>
051 Feed Offset	<p>Do this adjustment after you have eliminated the variation between the paper sources by 055/059/063/067/071/075</p> <p>This function adjusts the vertical position at which to start printing. The position moves lower on the sheet of paper as the value increases. This setting is used when doing single-sided printing or printing on the back side of the sheet of paper for duplex printing.</p> <p>Settings (default in bold):</p> <p>-3.5 ... 0.0 ... 3.5 mm in 0.5 mm increments</p>
052 Scan Offset	<p>Do this adjustment after you have eliminated the variation between the paper sources by 056/060/064/068/072/076.</p> <p>This function adjusts the horizontal position at which to start printing. The position moves to the right of the sheet of paper as the value increases. This setting is used when doing single-sided printing or printing on the back side of the sheet of paper for duplex printing.</p> <p>Settings (default in bold):</p> <p>-3.5 ... 0.0 ... 3.5 mm in 0.5 mm increments</p>
053 Feed Offset2	<p>Do this adjustment after you have eliminated the variation between the paper sources by 057/061/065/069/073/077.</p> <p>This function adjusts the vertical position at which to start printing. The position moves lower on the sheet of paper as the value increases. This setting is used when printing on the front side of the sheet of paper for duplex printing.</p> <p>Settings (default in bold):</p> <p>-3.5 ... 0.0 ... 3.5 mm in 0.5 mm increments</p>

Appendix

Item	Explanation
054 Scan Offset2	<p>Do this adjustment after you have eliminated the variation between the paper sources by 058/062/066/070/074/078.</p> <p>This function adjusts the horizontal position at which to start printing. The position moves to the right of the sheet of paper as the value increases. This setting is used when printing on the front side of the sheet of paper for duplex printing.</p> <p>Settings (default in bold): -3.5 ... 0.0 ... 3.5 mm in 0.5 mm increments</p>
055 Feed Reg1 MP 059 Feed Reg1 C1 063 Feed Reg1 C2* 067 Feed Reg1 C3* *AL-M320DN/AL-M310DN only	<p>Adjusts the vertical position at which to start printing and eliminate the variation between the paper sources. The position moves lower on the sheet of paper as the value increases. This setting is used when feeding paper for single-sided printing or printing on the back side of the sheet of paper for duplex printing.</p> <p>Settings (default in bold): -3.5 ... 0.0 ... 3.5 mm in 0.5 mm increments</p>
056 Scan Reg1 MP 060 Scan Reg1 C1 064 Scan Reg1 C2* 068 Scan Reg1 C3* *AL-M320DN/AL-M310DN only	<p>Adjusts the horizontal position at which to start printing and eliminate the variation between the paper sources. The position moves to the right of the sheet of paper as the value increases. This setting is used when feeding paper for single-sided printing or printing the back side of the sheet of paper for duplex printing.</p> <p>Settings (default in bold): -3.5 ... 0.0 ... 3.5 mm in 0.5 mm increments</p>
057 Feed Reg2 MP 061 Feed Reg2 C1 065 Feed Reg2 C2* 069 Feed Reg2 C3* *AL-M320DN/AL-M310DN only	<p>Adjusts the vertical position at which to start printing and eliminate the variation between the paper sources. The position moves lower on the sheet of paper as the value increases. This setting is used when feeding paper for printing on the front side of the sheet of paper for duplex printing.</p> <p>Settings (default in bold): -3.5 ... 0.0 ... 3.5 mm in 0.5 mm increments</p>
058 Scan Reg2 MP 062 Scan Reg2 C1 066 Scan Reg2 C2* 070 Scan Reg2 C3* *AL-M320DN/AL-M310DN only	<p>Adjusts the horizontal position at which to start printing and eliminate the variation between the paper sources. The position moves to the right of the sheet of paper as the value increases. This setting is used when feeding paper for printing on the front side of the sheet of paper for duplex printing.</p> <p>Settings (default in bold): -3.5 ... 0.0 ... 3.5 mm in 0.5 mm increments</p>
201 Highland	<p>Adjust this setting if black dots appear on the printed page when using the printer in locations at high altitudes. Increasing the value makes the printer more suited for higher altitudes. For the altitudes at which this printer can be operated, see "General" on page 103.</p> <p>Settings (default in bold): 0 ... 3 (step 1)</p>
202 Main Charger	<p>Adjusts the print density by correcting for the voltage of the main charger. The printout becomes lighter as the value increases.</p> <p>Settings (default in bold): 0 ... 4 ... 7 (step 1)</p>
203 Drum Refresh	<p>Refreshes the drum. It may alleviate smears on the printouts. Note that before refreshing the drum, make sure no paper is loaded in the MP tray.</p>

Appendix

Item	Explanation
207 Toner Install	Mixes toner in the developer to spread it evenly, this prevents the printouts from being too light. Do not turn off the printer until the LCD panel displays Ready.
209 Fuser Control	Select 1 if the fluorescent light flickers when printing.
	Settings (default in bold): 0 : Normal mode 1 : Reducing flicker mode
301 Noise Level	Adjusts the image gradation. As the value increases, the image gradation gets better, but the image granularity gets worse.
	Settings (default in bold): 0 ... 3 ... 7 (step 1)
303 Screen 25 304 Screen 50 305 Screen 100	Prints halftone or full pattern which allows you to check the unevenness of the density or pitch of the printout. 303 Screen 25 prints the pattern in a 25% density halftone. 304 Screen 50 prints the pattern in a 50 % density halftone. 305 Screen 100 prints the pattern at 100% density.

Consumable Products and Options

Consumable products

Product name	Part number	Remark
Standard Capacity Toner Cartridge	10080	<input type="checkbox"/> Storage temperature: 10 to 32.5°C (50 to 90.5°F) <input type="checkbox"/> Storage humidity: 15 to 80% RH <input type="checkbox"/> These products comply with CE marking requirements in accordance with EMC Directive 2004/108/EC.
High Capacity Toner Cartridge	10079	
Extra Capacity Toner Cartridge (for AL-M320DN)	10078	
Maintenance Unit A (for AL-M320DN/AL-M310DN)	10081	
Maintenance Unit B (for AL-M320DN/AL-M310DN)	10082	

Options

Product name	Part number	Remark
250-Sheet Paper Cassette Unit (for AL-M320DN/AL-M310DN)	C12C932811	This product complies with CE marking requirements in accordance with EMC Directive 2004/108/EC.

Appendix

Copyrights, Trademarks, and Licenses

EPSON, EPSON EXCEED YOUR VISION, EXCEED YOUR VISION, EPSON ESC Page, EPSON ESC/P and their logos are registered trademarks and Epson ESC/P2 are trademarks of Seiko Epson Corporation.

Microsoft®, Windows®, Windows Server®, Windows Vista®, and Wingdings® are registered trademarks of Microsoft Corporation.

Apple®, Mac®, Mac OS®, OS X®, Bonjour®, ColorSync®, FireWire®, Safari®, and TrueType® are registered trademarks of Apple, Inc.

HP and HP LaserJet are registered trademarks of the Hewlett-Packard Company.

PCL is the registered trademark of Hewlett-Packard Company.

Adobe, the Adobe logo, Acrobat, PostScript®3™, and Reader are either registered trademarks or trademarks of Adobe Systems Incorporated in the United States and/or other countries.

General Notice: Other product names used herein are for identification purposes only and may be trademarks of their respective owners. Epson disclaims any and all rights in those marks.

Copyright © 2017 Seiko Epson Corporation.

SOFTWARE LICENSE

- 1) This product includes open source software programs according to the license terms of each open source software program.
- 2) We provide the source code of some of such open source softwares until five (5) years after the discontinuation of same model of this printer product. If you desire to receive the source code above, please contact the customer support of your region. You shall comply with the license terms of each open source software program.

3) The open source software programs are WITHOUT ANY WARRANTY; without even the implied warranty of MERCHANTABILITY AND FITNESS FOR A PARTICULAR PURPOSE. See the license agreements of each open source software program for more details, which are described on \Manual\LICENSE.pdf.

4) The license terms of each open source software program are described on \Manual\LICENSE_D.pdf.

Standard and Approvals

European model:

Low Voltage Directive 2014/35/EU	EN 60950-1 EN 60825-1
EMC Directive 2014/30/EU	EN 55032 Class B EN 55024 EN 61000-3-2 EN 61000-3-3

Where To Get Help

Contacting Epson Support

Before Contacting Epson

If your Epson product is not operating properly and you cannot solve the problem using the troubleshooting information in your product documentation, contact Epson support services for assistance. If Epson support for your area is not listed below, contact the dealer where you purchased your product.

Epson support will be able to help you much more quickly if you give them the following information:

- Product serial number
(The serial number label is usually on the back of the product.)
- Product model
- Product software version
(Click **About**, **Version Info**, or similar button in the product software.)
- Brand and model of your computer
- Your computer operating system name and version
- Names and versions of the software applications you normally use with your product

Help for Users in Europe

Check your **Pan-European Warranty Document** for information on how to contact Epson support.

Help for Users in Taiwan

Contacts for information, support, and services are:

World Wide Web

<http://www.epson.com.tw>

Information on product specifications, drivers for download, and products enquiry are available.

Epson HelpDesk

Phone: +886-2-80242008

Our HelpDesk team can help you with the following over the phone:

- Sales enquiries and product information

Where To Get Help

- Product usage questions or problems
- Enquiries on repair service and warranty

Repair service center:

<http://www.tekcare.com.tw/branchMap.page>

TekCare corporation is an authorized service center for Epson Taiwan Technology & Trading Ltd.

Help for Users in Singapore

Sources of information, support, and services available from Epson Singapore are:

World Wide Web

<http://www.epson.com.sg>

Information on product specifications, drivers for download, Frequently Asked Questions (FAQ), Sales Enquiries, and Technical Support via e-mail are available.

Epson HelpDesk

Phone: (65) 6586 3111

Our HelpDesk team can help you with the following over the phone:

- Sales enquiries and product information
- Product usage questions or problems
- Enquiries on repair service and warranty

Help for Users in Thailand

Contacts for information, support, and services are:

World Wide Web

<http://www.epson.co.th>

Information on product specifications, drivers for download, Frequently Asked Questions (FAQ), and e-mail are available.

Epson Hotline

Phone: 66-2685-9899

Our Hotline team can help you with the following over the phone:

- Sales enquiries and product information

Where To Get Help

- Product usage questions or problems
- Enquiries on repair service and warranty

Help for Users in Vietnam

Contacts for information, support, and services are:

Epson Hotline

Phone: 84-8-823-9239

Service Center: 80 Truong Dinh Street, District 1, Hochiminh City
Vietnam

Help for Users in Indonesia

Contacts for information, support, and services are:

World Wide Web

<http://www.epson.co.id>

- Information on product specifications, drivers for download
- Frequently Asked Questions (FAQ), Sales Enquiries, questions through e-mail

Epson Hotline

Phone: +62 1500-766

Fax: +62-21 808 66-799

Our Hotline team can help you with the following over the phone or fax:

- Sales enquiries and product information
- Technical support

Epson Service Center

Province	Company Name	Address	Phone E-mail
DKI JAKARTA	ESS Jakarta MG. DUA	RUKO MANGGA DUA MALL NO. 48 JL. ARTERI MANGGA DUA - JAKARTA UTARA- DKI	(+6221)62301104 jkt-technical1@epson-indone sia.co.id
NORTH SUMATERA	ESC Medan	Kompleks Graha Niaga, Jl. Bambu II No. A-4, Medan- 20114	(+6261)42066090/42066091 mdn-technical@epson-indon esia.co.id

Where To Get Help

Province	Company Name	Address	Phone E-mail
WEST JAWA	ESC Bandung	JL. CIHAMPELAS NO. 48A-BANDUNG JABAR 40116	(+6222)4207033 bdg-technical@epson-indonesia.co.id
DI YOGYAKARTA	ESC Yogyakarta	YAP Square, Blok A No.6 Jl. C Simanjutak YOGYAKARTA - DIY	(+62274)581065 ygy-technical@epson-indonesia.co.id
EAST JAWA	ESC Surabaya	HITECH MALL LT.2 BLOK A NO. 24 JL. KUSUMA BANGSA NO. 116 -118 - SURABAYA JATIM	(+6231)5355035 sby-technical@epson-indonesia.co.id
SOUTH SULAWESI	ESC Makassar	JL. GUNUNG BAWAKARAENG NO. 68E - MAKASSAR SULSEL	(+62411)328212 mksr-technical@epson-indonesia.co.id
WESTKALIMANTAN	ESC Pontianak	JL. NUSA INDAH I NO. 40A PONTIANAK KALBAR 78117	(+62561)735507 pontianak-technical@epson-indonesia.co.id
PEKANBARU	ESC PEKANBARU	JL. TUANKU TAMBUSAI NO. 353 - PEKANBARU RIAU	(+62761)21420 pkb-technical@epson-indonesia.co.id
DKI JAKARTA	ESS JAKARTA KEIAI	WISMA KEIAI LT. 1 JL. JEND. SUDIRMAN KAV. 3 JAKPUS DKI JAKARTA	(+6221)5724335 ess.support@epson-indonesia.co.id
EAST JAWA	ESS SURABAYA	JL. JAWA NO. 2-4 KAV. 29, RUKO SURYA INTI, SURABAYA - JATIM	(+6231)5014949 esssby.support@epson-indonesia.co.id
BANTEN	ESS SERPONG	Ruko mall WTC MATAHARI no. 953 SERPONG - Banten	(+6221)53167051 esstag.support@epson-indonesia.co.id
CENTRAL JAWA	ESS SEMARANG	Komplek Ruko Metro Plaza Blok C20 , Jl. MT Haryono No 970 Semarang - Jawa tengah	(+6224)8313807 esssmg.support@epson-indonesia.co.id
EAST KALIMANTAN	ESC SAMARINDA	Jl. KH. Wahid Hasyim (M. Yamin) Kel. Sempaja Selatan Kec. Samarinda Utara Samarinda- Kalimantan Timur (samping kantor pos)	(+62541)7272904 escsmd.support@epson-indonesia.co.id
SOUTH SUMATERA	ESC PALEMBANG	Jl. H.M. Rasyid Nawawi no.249, kelurahan 9 ilir Palembang - Sumsel	(+62711)311330 escplg.support@epson-indonesia.co.id
EAST JAVA	ESC JEMBER	Jl. Panglima Besar Sudirman No.1 D JEMBER - JAWA TIMUR (Depan Balai Penelitian dan Pengolahan Kakao)	(+62331) 486468,488373 jmr-admin@epson-indonesia.co.id jmr-technical@epson-indonesia.co.id

Where To Get Help

Province	Company Name	Address	Phone E-mail
NORTH SULAWESI	ESC MANADO	Tekno @Megamall, Megamall LG TK-21 Jl. Piere Tendean Kawasan Megamas Boulevard Manado 95111	(+62431)7210033 MND-ADMIN@EPSON-INDON ESIA.CO.ID

For other cities not listed here, call the Hot Line: 08071137766.

Help for Users in Hong Kong

To obtain technical support as well as other after-sales services, users are welcome to contact Epson Hong Kong Limited.

Internet Home Page

<http://www.epson.com.hk>

Epson Hong Kong has established a local home page in both Chinese and English on the Internet to provide users with the following information:

- Product information
- Answers to Frequently Asked Questions (FAQs)
- Latest versions of Epson product drivers

Users can access our World Wide Web home page at:

Technical Support Hotline

You can also contact our technical staff at the following telephone and fax numbers:

Phone: 852-2827-8911

Fax: 852-2827-4383

Help for Users in Malaysia

Contacts for information, support, and services are:

World Wide Web

<http://www.epson.com.my>

- Information on product specifications, drivers for download
- Frequently Asked Questions (FAQ), Sales Enquiries, questions through e-mail

Where To Get Help

Epson Helpdesk

- Sales enquiries and product information (Infoline)

Phone: 603-56288222

- Enquiries on repair services & warranty, product usage and technical support (Techline)

Phone: 603-56288333

Head Office

Phone: 603-56288288

Fax: 603-5628 8388

Help for Users in the Philippines

World Wide Web

<https://www.epson.com.ph>

Information on product specifications, drivers for download, Frequently Asked Questions (FAQ), and E-mail Enquiries are available.

Technical support

To obtain technical support as well as other after sales services, users are welcome to contact the Epson Philippines Corporation at the telephone and fax numbers and e-mail address below:

Trunk Line: (63-2) 706 2609

Fax: (63-2) 706 2665

Helpdesk Direct Line: (63-2) 706 2625

E-mail: epchelpdesk@epc.epson.com.ph

Our Hotline team can help you with the following over the phone:

- Sales enquiries and product information
- Product usage questions or problems
- Enquiries on repair service and warranty