

Control Panel Operation

The control panel is made up of three elements: a liquid crystal display (LCD) panel, indicator lights, and buttons. The LCD panel and indicator lights tell you the current status of the printer, and you can use the control panel buttons to make printer settings, check consumable products, and print status sheets. However, settings made in your application and in the printer driver usually override settings made at the control panel.

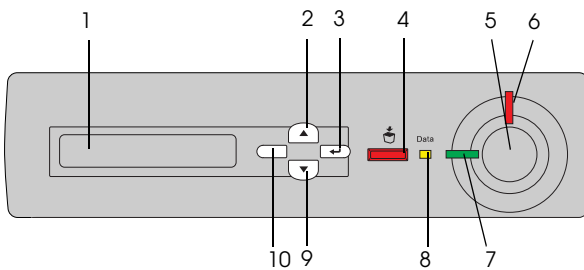

- | | |
|---|---|
| <p>1 LCD panel Displays printer status messages and control panel menu settings.</p> <p>2 Up Use these buttons to access the control panel menus, where you can make printer settings and check the status of consumable products. For instructions on how to use each button, see "Using the Control Panel Menus" in the <i>Reference Guide</i>.</p> <p>3 Enter</p> <p>9 Down</p> <p>10 Back buttons</p> | <p>4 Job Cancel button Press once to cancel the current print job. Press down for more than two seconds to delete all jobs from the printer memory, including jobs the printer is currently receiving, saving to the Hard Disk Drive, or printing.</p> <p>5 Start/Stop button Switches the printer between ready and offline status. When the error light is flashing, pressing this button clears the error and switches the printer to ready status.</p> <p>6 Error light (Red) On or flashes when an error has occurred.</p> <p>7 Ready light (Green) On when the printer is ready, indicating that the printer is ready to receive and print data. When the printer is not ready, this light is off.</p> <p>8 Data light (Yellow) On when print data is stored in the print buffer (the section of printer memory reserved for receiving data) but not yet printed. Flashing when the printer is processing data. Off when no data remains in the print buffer.</p> |
|---|---|

How to access the control panel menus

This section explains how to access, use, and exit the control panel menus. Refer to the illustrations below for an overview of the control panel button functions, and see the steps later in this section for detailed instructions.

For a complete description of the items and settings available in the control panel menu, see "Control Panel Menu" in the *Reference Guide*.

Accessing the control panel menu

When the printer's Ready light is on, pressing any of the control panel buttons shown below accesses the control panel menu.

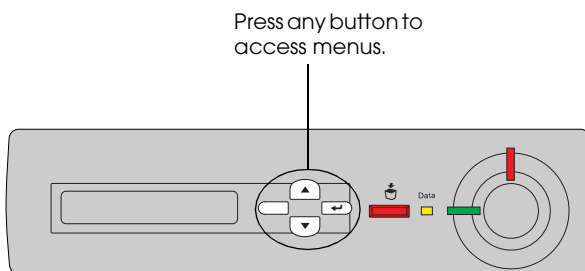



Using the control panel buttons

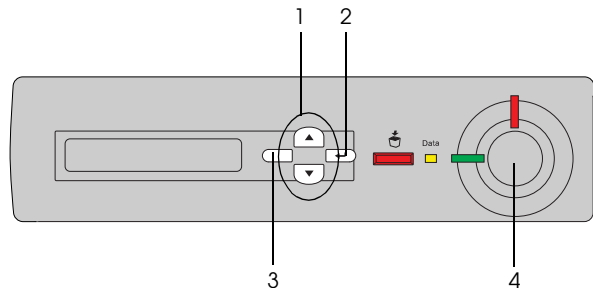

Once you've accessed the menus, the control panel buttons function as shown below.



- | | |
|----------------------|--|
| 1. Up/Down buttons | Scrolls through menus, items, and settings on the current level. |
| 2. Enter button | Advances to the next level, carry out indicated operations, and activate settings. |
| 3. Back button | Returns to the previous level. |
| 4. Start/Stop button | Exits the control panel menu from any level. |

How to use the menus

1. Make sure the Ready light is on, then press any of the buttons indicated above to access the menus.
2. Use the ▲ Up and ▼ Down buttons to scroll through the menus.
3. Press the  Enter button to view the items in a menu. Depending on the menu, the LCD panel displays an item and the current setting separated by an asterisk (YYYY*ZZZZ), or only an item (YYYY).
4. Use the ▲ Up and ▼ Down buttons to scroll through the items, or press the  Back button to return to the previous level.
5. Press the  Enter button to carry out the operation indicated by an item, such as printing a status sheet or resetting the printer, or to view the settings available for an item, such as paper sizes or emulation modes.

Use the ▲ Up and ▼ Down buttons to scroll through available settings, and press the  Enter button to select a setting and return to the previous level. Press the  Back button to return to the previous level without changing the setting.

Note:

You need to turn the printer off and then on to activate some settings. For details, see "Control Panel Menus" in the Reference Guide.

6. Press the Start/Stop button to exit the control panel menus.

Status and Error Messages

This section contains a list of error messages shown on the LCD panel, giving a brief description of each message and suggestions for correcting the problem. Note that not every message shown on the LCD panel indicates a problem.

Calibrating Printer

The printer automatically calibrates itself when any of its covers is opened and when there is no paper jammed inside. This is not an error message, and will clear itself after one minute. While the printer displays this message, do not open the covers or turn off the printer.

Cancel All Print Job

The printer is canceling all print jobs in the printer memory, including jobs the printer is currently receiving or printing. This message appears when the  Job Cancel button has been pressed down for more than 2 seconds.

Cancel Print Job

The print is canceling the current print job. This message appears when the  Job Cancel button has been pressed and released within 2 seconds.

Cannot Print Duplex

The printer has encountered problems during duplex printing. Make sure you are using an appropriate type and size of paper for the Duplex Unit. The problem could also be a result of incorrect settings for the paper source you are using. Pressing the Start/Stop button will print the rest of the print job on only one side of the paper. Press the  Job Cancel button to cancel the print job.

Check Paper Size

The paper size setting is different from the size of paper loaded in the printer. Check to see if the correct size of paper is loaded in the specified paper source.

To clear this error, select **Clear Warning** from the control panel's Reset Menu. See "How to access the control panel menus" for instructions.

Check Paper Type

The media loaded in the printer does not match the paper type setting in the printer driver. Media that matches only the paper size setting will be used for printing.

To clear this error, select **Clear Warning** from the control panel's Reset Menu. See "How to access the control panel menus" for instructions.

Check Transparency

You have loaded media other than transparencies when the Paper Type setting in the printer driver is Transparency. The printer stops loading to prevent printer damage. Load transparencies in the specified paper source, then press the Start/Stop button.

Collate was disabled

Printing by specifying the number of copies is no longer possible due to a lack of memory (RAM) or free disk space on the optional Hard Disk Drive. If this error occurs, print only one copy at a time.

To clear this error, select **Clear Warning** from the control panel's Reset Menu. See "How to access the control panel menus" for instructions.

Cover A Open

Cover A, the output path cover on the left side of the printer, is open. Close the cover and the error is automatically cleared.

Cover D Open

Cover D, the paper cassette cover on the right side of the printer, is open. Close the cover and the error is automatically cleared.

Cover E Open

Cover E, the cover on the right side of the optional Large Capacity Paper Unit, is open. Close the cover and the error is automatically cleared.

Cover F Open

Cover F, the optional Duplex Unit's inverter cover on the left side of the printer, is open. Close the cover and the error is automatically cleared.

Duplex Mem Overflow

There is not enough memory for duplex printing. The printer prints only on the front and ejects the paper. To clear this error, follow the instructions below.

If **Off** is selected as the Auto Cont setting on the control panel's Setup Menu, press the Start/Stop button to print on the back of the next sheet, or press the  Job Cancel button to cancel the print job.

If **On** is selected as the Auto Cont setting on the control panel's Setup Menu, printing continues automatically after a certain period of time.

Format Error ROM A/Format Error Rom B

An unformatted ROM module has been inserted. If the ROM module has been formatted, but is still unreadable, format it again. If the ROM is still unreadable after reformatting, take the module to your dealer for repair or replacement.

To clear this error, either press the Start/Stop button or turn off the printer and remove the ROM module.

Form Data Canceled

Unable to store form overlay data on the printer's Hard Disk Drive. Either the drive is full, or the maximum number of form overlay files has been reached. Delete any form overlay files you no longer need, then try storing the new overlay again.

To clear this error, select **Clear Warning** from the control panel's Reset Menu. See "How to access the control panel menus" for instructions.

Form Feed

The printer is ejecting paper due to a printing error. This message appears when the Start/Stop button has been held down for more than 2 seconds in order to recover from a printing error.

Front Cover Open

The front cover is open. Close the cover and the error is automatically cleared.

Hard Disk Full

The printer has insufficient memory. Delete the unnecessary data from the Hard Disk Drive. To clear this error, select **Clear Warning** from the control panel's Reset Menu. See "How to access the control panel menus" for instructions.

HDD Check

The printer is checking the Hard Disk Drive.

*HDD Format ***%*

The printer is formatting the optional Hard Disk Drive. *** indicates the formatting progress.

Image Optimum

There is insufficient memory to print the page at the specified print quality. The printer automatically lowers the print quality so that it can continue printing. If the quality of the printout is not acceptable, try simplifying the page by limiting the number of graphics or reducing the number and size of fonts.

To clear this error, select **Clear Warnings** from the control panel's **Reset Menu**. See "How to access the control panel menus" for instructions.

Turn the **Image Optimum** setting off on the control panel's **Printing Menu** if you do not want the printer to automatically lower the print quality to continue printing.

You may need to increase the amount of printer memory to be able to print at the desired print quality for your document. For more information on adding memory, see "Memory module" in the *Reference Guide*.

Install Photoconductor

There is no photoconductor unit installed or the photoconductor unit is not installed properly. Turn off the printer and install the photoconductor unit if it is not installed.

If a photoconductor unit is already installed, turn off the printer, open cover A, then open cover D. Remove the photoconductor unit, then reinstall it properly. Close covers D and A. The error clears automatically if the photoconductor unit is properly installed.

Install Waste T Box

The waste toner collector is not installed, or is installed incorrectly. If there is no waste toner collector installed, install one in the printer. If there is a waste toner collector already installed, try removing it and reinstalling it. See "Replacing the waste toner collector" in the *Reference Guide* for instructions.

Invalid AUX I/F Card

This message means that the printer cannot communicate with the installed optional interface card. Turn off the printer, remove the card, then reinstall it.

Invalid HDD

Either the optional Hard Disk Drive is damaged or it cannot be used with this printer. Turn off the printer and remove the Hard Disk Drive.

Invalid IPDS

Turn off the printer and replace the IPDS module.

Invalid PS3

An optional PostScript 3 ROM module that cannot be used on this printer is installed. Turn off the printer and remove the module.

Invalid ROM A/Invalid ROM B

The printer cannot read the installed optional ROM module. Turn off the printer and remove the ROM module.

To clear this error, select **Clear Warnings** from the control panel's **Reset Menu**. See "How to access the control panel menus" for instructions.

Irregular Density

If you try to print on media of overly high density, the printer stops loading the media to prevent printer damage. In this case, you need to clear any jammed media from the MP tray or the paper path unit.

Jam XX

The location where the paper jam occurred is displayed at xxxx. xxxx indicates the location of the error.

If a paper jam occurs at two or more locations simultaneously, the corresponding multiple locations are displayed.

Jam A	Paper is jammed inside the output path cover (cover A). For instructions on how to remove jammed paper at the output path cover, see "Paper Jam - Cover A (Jam A)".
Jam B	Paper is jammed inside the fuser unit (unit B). For instructions on how to remove jammed paper at the fuser unit, see "Paper Jam - Cover B (Jam B)".
Jam C	Paper is jammed inside the paper path unit (unit C). For instructions on how to remove jammed paper at the paper path unit, see "Paper Jam - Unit C (Jam C)".
Jam D	Paper is jammed inside the paper cassette cover (cover D). For instructions on how to remove jammed paper at the paper cassette cover, see "Paper Jam - Cover D (Jam D)".
Jam E	Paper is jammed inside the cover on the right side of the optional Large Capacity Paper Unit (cover E). For instructions on how to remove jammed paper at the right side of the Large Capacity Paper Unit, see "Paper Jam - Cover E (Jam E)".

Jam F	Paper is jammed inside the optional Duplex Unit's inverter cover (cover F). For instructions on how to remove jammed paper at the Duplex Unit's inverter cover, see "Paper Jam - Cover F (Jam F)".
Jam G	Paper is jammed inside the optional Duplex Unit's main unit (unit G). For instructions on how to remove jammed paper at the Duplex Unit's main unit, see "Paper Jam - Unit G (Jam G)".

Manual Feed xxx

The manual feed mode is specified for the current print job. Make sure the paper size indicated by xxx is loaded, then press the Start/Stop button.

If you do not want to print this job in manual mode, press the Start/Stop button. The printer feeds paper from the specified paper source.

For details on the manual feed mode, see "Manually feeding paper".

Mem Overflow

The printer has insufficient memory to execute the current task. Press the Start/Stop button on the control panel to resume printing. Or press the  Job Cancel button to cancel the print job.

Menus Locked

This message appears if you try to change the printer's settings through the control panel when the buttons are locked. You can unlock them by using the EPSON WinAssist or WebAssist utility. Refer to the *Administrator's Guide* for information.

Need Memory

The printer has insufficient memory to complete the current print job. Cancel printing by deleting it from the print queue on your computer, or by pressing the  Job Cancel button on the printer.

To clear this error message, select **Clear Warnings** from the control panel's **Reset Menu**. See "How to access the control panel menus" for instructions.

To prevent this problem from happening again, add more memory to your printer as described in "Memory module" in the *Reference Guide*.

Offline

The printer is not ready to print. Press the Start/Stop button.

Optional RAM Error

The optional memory module may be corrupted or incorrect. Replace it with a new one.

Outbin Select Error

Printouts are not output to the specified output tray, but to another tray due to a printing restriction.

Paper Out XXX YYY

There is no paper in the specified paper source (XXX). Load paper of the indicated size (YYY) into the paper source.

Paper Set XXX YYY

The paper loaded in the specified paper source (XXX) does not match the required paper size (YYY). Replace the loaded paper with the correct size paper and press the Start/Stop button to resume printing. Or press the  Job Cancel button to cancel the print job.

If you press the Start/Stop button without replacing the paper, the printer will print on the loaded paper even though it does not match the required size.

Photoconductor Trouble

The installed photoconductor unit has a problem. Turn off the printer, remove the photoconductor unit and install a new photoconductor unit. See "Replacing the photoconductor unit" in the *Reference Guide*.

Print Overrun

The required time to process the print data exceeded the print engine speed because the current page is too complex. Press the Start/Stop button to resume printing. Or press the  Job Cancel button to cancel the print job. If this message appears again, select **On** as the Page Protect setting in the control panel's Setup Menu.

If you continue to receive this message when printing a particular page, try simplifying the page by limiting the number of graphics or reducing the number and size of fonts.

You can also add more memory to the printer as described in "Memory module" in the *Reference Guide*.

PS3 Hard Disk full

The memory allocated for writing PostScript 3 commands on the optional Hard Disk Drive is full.

To clear this error, select **Clear Warnings** from the control panel's **Reset Menu**. See "How to access the control panel menus" for instructions.

RAM Check

The printer is checking the RAM.

Ready

The printer is ready to receive data and print.

Replace Photoconductr

The photoconductor unit has reached the end of its service life. Turn off the printer, then replace the photoconductor unit with a new one. See "Photoconductor Unit" in the *Reference Guide* for instructions.

The error clears automatically after you replace the unit and close all printer covers. The photoconductor service life counter is reset automatically.

Replace Waste T Box

The waste toner collector is full of toner. Replace it with a new waste toner collector. See "Replacing the waste toner collector" in the *Reference Guide*.

The error clears itself after you have replaced the waste toner collector and close the front cover.

Reserve Job Canceled

The printer cannot store the data of your print job using the Reserve Job function. The maximum number of print jobs stored in the printer's Hard Disk Drive has been reached, or the drive has no more memory available to store a new job. To store a new print job, delete a previously stored job. Also, if you have any Confidential Jobs stored, printing those jobs will make more memory available.

To clear this error, select `Clear Warning` from the control panel's Reset Menu. See "How to access the control panel menus" for instructions.

Reset

The printer's current interface has been reset and the buffer has been cleared. However, other interfaces are still active and retain their settings and data.

Reset All

All printer settings have been reset to the default configuration, or to the last settings that were saved.

Reset to Save

A control panel menu setting was changed while the printer was printing. Press the Start/Stop button to clear this message. The setting will become effective after printing has finished.

ROM Check

The printer is checking the ROM.

Self Test

The printer is performing a quick internal check.

Service Req xyyy

A controller error or a print engine error has been detected. Turn off the printer. Wait at least 5 seconds and then turn it back on. If the error message still appears, write down the error number listed on the LCD panel (xyyy) and turn off the printer, unplug the power cord, and contact a qualified service representative.

Standby

The printer is in stand-by mode.

Time exceeded

Paper was forcibly output (blank sheet printing) as the print data did not arrive in time even though paper was pre-fed.

Toner Cart Out

One or more toner cartridges are not installed in the printer.

Install the cartridges. See "Toner Cartridge" in the *Reference Guide*.

Turn Paper XXX

Paper is loaded in the wrong orientation in the XXX cassette. Remove the paper stack from the standard lower cassette, turn it by 90 degrees, and reload it with the long edge first.

Unable Clear Error

The printer cannot clear an error message because the error status still remains. Try solving the problem again.

Unit B Open

The fuser unit is open. The error automatically clears itself when the fuser unit is closed properly.

Unit C Open

The paper path unit is open. The error automatically clears itself when the paper path unit is closed properly.

Unit G Open

The optional Duplex Unit's main unit is open. The error automatically clears itself when the Duplex Unit's main unit is closed properly.

Warming Up

The printer is warming up.

Waste T Box Nearfull

The waste toner collector is nearly full of toner. You can continue to print until the `Replace Waste T Box` error message appears, but early replacement is recommended to maintain high print quality. See "Replacing the waste toner collector" in the *Reference Guide*.

Worn Fuser

This message indicates that the fuser unit is near the end of its service life. Turn the printer off, then replace the fuser unit with a new one. Contact your dealer.

To clear this warning message and continue printing, select `Clear Warning` from the control panel's Reset Menu. See "How to access the control panel menus" for instructions.

Worn Photoconductor

This message indicates that the photoconductor unit is near the end of its service life. You can continue to print until the `Replace Photocondctr` error message appears, but early replacement is recommended to maintain high print quality.

To clear this warning message and continue printing, select `Clear Warning` from the control panel's Reset Menu. See "How to access the control panel menus" for instructions.

Write Error ROM A/Write Error ROM P

This message indicates an internal error in the printer. Reset the printer. If this error persists, consult your dealer.

Writing ROM A/Writing ROM P

This message indicates an internal error in the printer. Reset the printer. If this error persists, consult your dealer.

Wrong Photoconductr

You have installed a photoconductor unit that has not been designed for this printer. Turn off the printer, remove the incorrect photoconductor unit and install one designed for this printer (S051082). See "Replacing the photoconductor unit" in the *Reference Guide*.

XXXX Toner Low

The indicated toner cartridges have less than 10% of toner remaining. (The letters C, M, Y, or K appear in place of XXXX and indicate the colors Cyan, Magenta, Yellow, and Black respectively.)

You can continue to print until the XXXX Toner Out error message appears. Waiting until this message appears before replacing the toner is recommended as toner may spill during replacement if toner remains in the cartridge. When printouts become faint, see "Toner Cartridge" in the *Reference Guide* for instructions.

To clear this error, select `Clear Warning` from the control panel's Reset Menu. See "How to access the control panel menus" for instructions.

XXXX Toner Out

The indicated toner cartridges are out of toner and need to be replaced. (The letters C, M, Y, or K appear in place of XXXX and indicate the colors Cyan, Magenta, Yellow, and Black respectively.)













See "Toner Cartridge" in the *Reference Guide* for instructions.

Printing and Deleting Reserve Job Data

Print jobs stored on the printer's optional Hard Disk Drive using the Re-Print Job, Verify Job, and Stored Job options of the Reserve Job function can be printed and deleted using the control panel's Quick Print Job Menu. Jobs saved using the Confidential Job option can be printed from the Confidential Job Menu. Follow the instructions in this section.

Using the Quick Print Job Menu

Follow these steps to print or delete Re-Print Job, Verify Job, and Stored Job data.







1. Make sure the LCD panel displays **Ready** or **Standby**, then press the  Enter button to access the control panel menus.
2. Press the  Down button repeatedly until **Quick Print Job Menu** appears on the LCD panel, then press the  Enter button.
3. Use the  Down or  Up button to scroll to the appropriate user name, then press the  Enter button.
4. Use the  Down or  Up button to scroll to the appropriate job name, then press the  Enter button.
5. To specify the number of copies you want to print, press the  Enter button, then use the  Down and  Up buttons to select the number of copies.

To delete the print job without printing any copies, press the  Down button to display **Delete** on the LCD panel.

6. Press the  Enter button to start printing or to delete the data.



Using the Confidential Job Menu

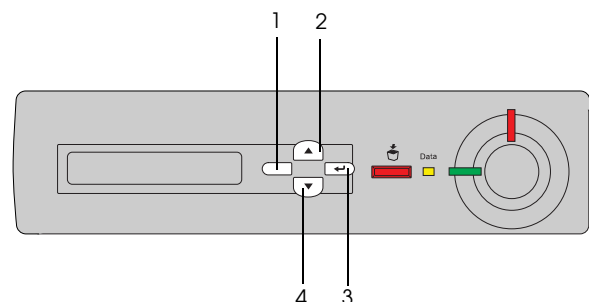

Follow these steps to print or delete Confidential Job data.

1. Make sure the LCD panel displays **Ready** or **Standby**, then press the  Enter button to access the control panel menus.
2. Press the  Down button repeatedly until **Confidential Job Menu** appears on the LCD panel, then press the  Enter button.
3. Use the  Down or  Up button to scroll to the appropriate user name, then press the  Enter button.
4. Enter your four-digit password by using the corresponding buttons, as shown below.



Note:

-  Passwords are always four digits.
-  Passwords consist of numbers from 1 through 4.
-  If no print jobs have been saved with the password you entered, **Password Error** appears briefly on the LCD panel then the printer exits the control panel menus. Confirm the password and try again.

5. Use the ▼ Down or ▲ Up button to scroll to the appropriate job name, then press the  Enter button.
6. To specify the number of copies you want to print, press the  Enter button, then use the ▼ Down and ▲ Up buttons to select the number of copies.

To delete the print job, press the ▼ Down button to display `Delete` on the LCD panel.

7. Press the  Enter button to start printing or to delete the data.

Clearing Jammed Paper

When paper is jammed in the printer, the printer's LCD panel and the EPSON Status Monitor 3 utility provide alert messages.

Error messages for paper jams

If the following message appears on the LCD panel, you must clear all jammed paper.

Jam xxxx

The location where the paper jam occurred is displayed at xxxx. xxxx indicates the location of the paper jam. Use the illustrations below as a guide for the printer parts indicated.

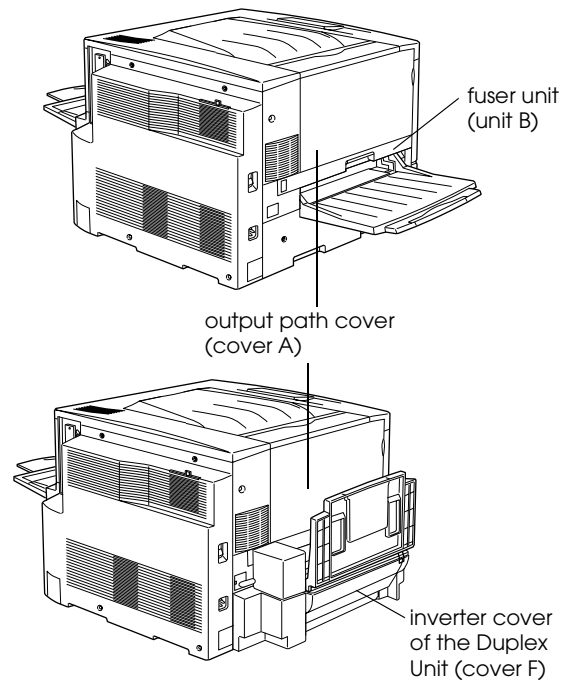
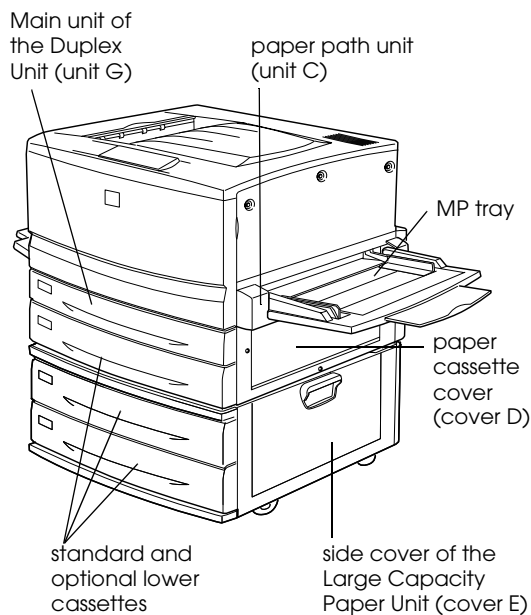

If a paper jam occurs at two or more locations simultaneously, the corresponding multiple locations are displayed.

Jam A	Paper is jammed inside the output path cover (cover A).
Jam B	Paper is jammed inside the fuser unit (unit B).
Jam C	Paper is jammed inside the paper path unit (unit C).
Jam D	Paper is jammed inside the paper cassette cover on the right side of the printer (cover D). If you cannot find any jammed paper in this cover, check the optional Duplex Unit's inverter cover (cover F), then its main unit (unit G).
Jam E	Paper is jammed at the side cover of the optional Large Capacity Paper Unit (cover E).

Jam F	<p>Paper is jammed at the optional Duplex Unit's inverter cover (cover F).</p> <p>If you cannot find any jammed paper in this cover, check the paper cassette cover (cover D), then optional Duplex Unit's main unit (unit G).</p>
Jam G	<p>Paper is jammed inside the optional Duplex Unit's main unit (unit G).</p> <p>Be sure to check if the jammed paper is not in the paper cassette cover (cover D) or the Duplex Unit's inverter cover (cover F) before checking the main unit of the Duplex Unit.</p>

Precautions for clearing jammed paper

Be sure to observe the following points when you clear jammed paper:

- ❑ Do not remove jammed paper by force. Torn paper can be difficult to remove and might cause other paper jams. Pull it gently in order to avoid tearing.
- ❑ Always try to remove jammed paper with both hands to avoid tearing it.
- ❑ If jammed paper is torn and remains in the printer, or if paper is jammed in a place not mentioned in this chaptersection, contact your dealer.



Warning:

- ❑ Be careful not to touch the fuser, which is marked CAUTION! HIGH TEMPERATURE, or the surrounding areas. If the printer has been in use, the fuser and the surrounding areas may be very hot.
- ❑ Do not insert your hand deep into the fuser unit (unit B) as some components are sharp and may cause injury.

Paper Jam - the Lower Cassette

This section describes how to clear paper jams from the printer's standard and optional lower cassettes. The procedure is the same for all lower cassettes.

Follow these steps to clear paper jams in the lower cassettes. The illustrations show the standard lower cassette.

1. Pull the lower cassette out slowly until it stops. Be careful not to tear the jammed paper.

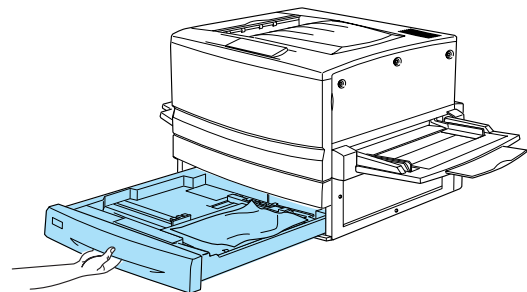

2. Remove any jammed or crumpled paper.

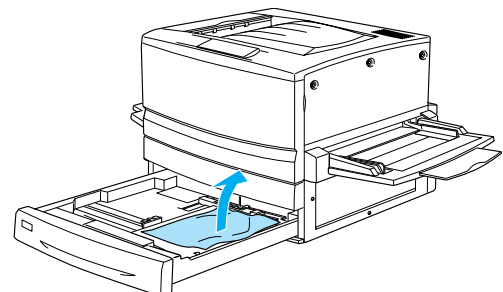

Note:

If paper is torn, be sure to remove all torn pieces.

3. Remove the stack of paper from the cassette.
4. Tap the stack of paper on a flat surface to even out the edges, then reinsert it into the lower cassette. Be sure the paper is evenly aligned and the top of the stack is below the metal retaining clip and the maximum paper mark.

5. Push the lower cassette back into the printer.

When the paper jam is cleared completely and the lower cassette is pushed back into the printer, the jammed page's print data is automatically reprinted.

Paper Jam - MP tray

Follow these steps to clear paper jams at the MP tray.

1. Pull the jammed paper out gently.

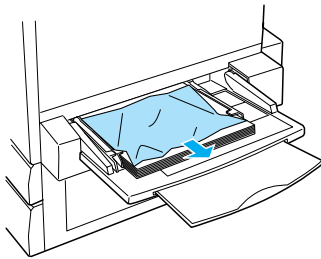

Caution:

If the jammed paper is visible deep inside the MP tray, do not pull the paper. Pull out the paper path unit to remove the jammed paper.

2. Remove and tap the remaining paper stack on a flat surface to even out the edges before reloading it into the MP tray.

Paper Jam - Cover A (Jam A)

When paper is jammed at the output path cover, the LCD panel displays the Jam A error message.

Follow these steps to clear paper jams in the output path cover.

1. Open the output path cover on the left side of the printer.

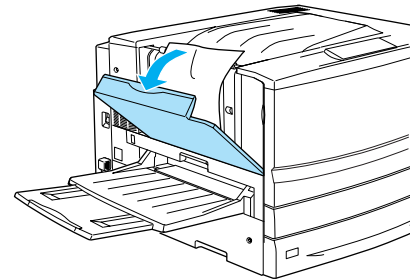

2. Remove any jammed paper gently with both hands. Be careful not to tear the jammed paper.

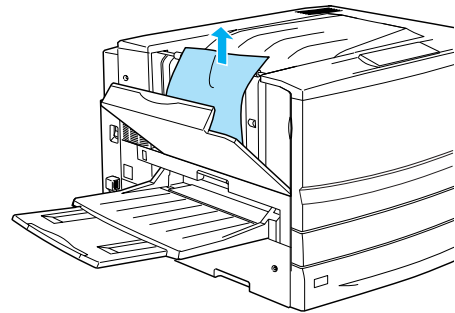

Note:

- Always try to remove jammed paper with both hands to avoid tearing it.
- If paper is torn, be sure to remove all torn pieces.

3. Close the output path cover.

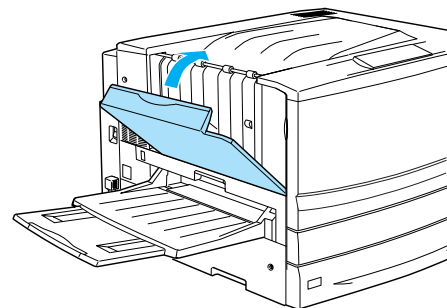

When the paper jam is cleared completely and the output path cover (cover A) is closed, the jammed page's print data is automatically reprinted.

Paper Jam - Cover B (Jam B)

When paper is jammed at the fuser unit, the LCD panel displays the **Jam B** error message.

Follow these steps to clear paper jams in the fuser unit.

1. Pull the fuser unit out gently until it stops. Be careful not to tear the jammed paper.

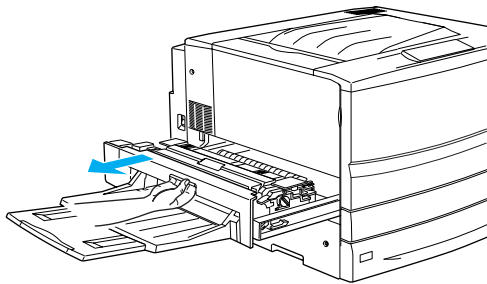

Warning:
Do not insert your hand deep into the fuser unit (unit B) as some components are sharp and may cause injury.

2. Pull the lever up to release the paper path.

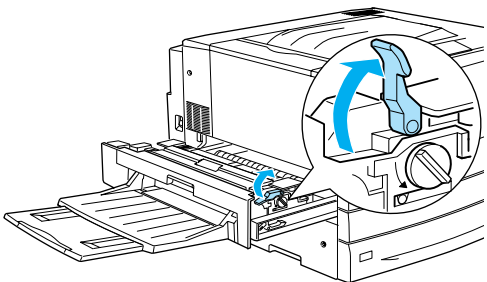

Warning:
Do not touch the fuser, which is marked **CAUTION! HIGH TEMPERATURE**, or the surrounding areas. If the printer has been in use, the fuser and the surrounding areas may be very hot.

3. Turn the knob in the fuser unit to eject the jammed paper.

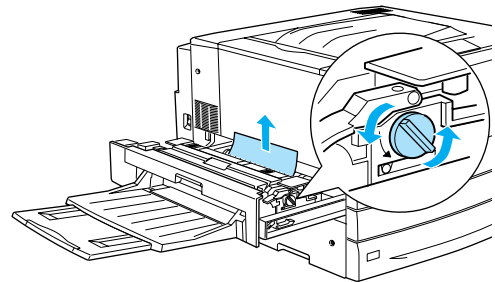

4. Gently remove the jammed paper with both hands. Be careful not to tear the jammed paper.

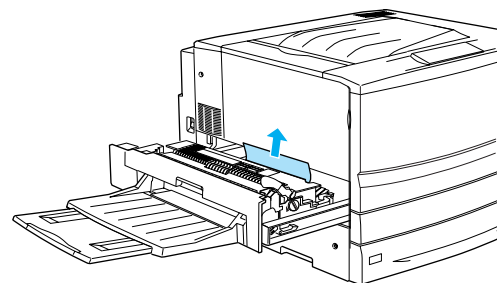

Note:

- ❑ Be sure to remove the jammed paper by pulling it upward.
- ❑ If paper is torn, be sure to remove all torn pieces.

If the Duplex unit is attached, follow the next step. If you see the paper remaining but cannot remove it, open the cover and remove the paper as shown below.

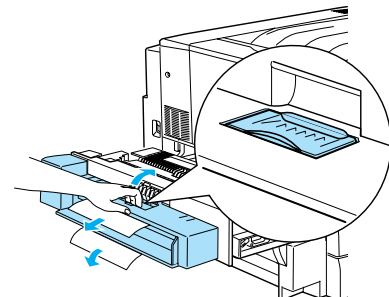

5. Make sure that jammed paper is not remained inside the fuser unit.
6. Push the fuser unit back into the printer firmly.

When the paper jam is cleared completely and the fuser unit (unit B) is pushed back into the printer, the jammed page's print data is automatically reprinted.

3. Gently remove the jammed paper with both hands.

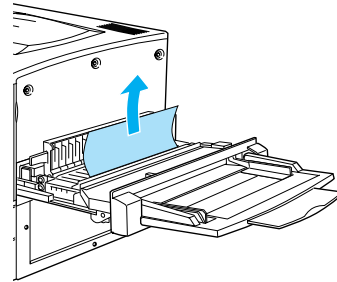

Paper Jam - Unit C (Jam C)

When paper is jammed at the paper path unit, the LCD panel displays the **Jam C** error message.

Follow these steps to clear paper jams in the paper path unit.

1. Pull the paper path unit out until it stops.

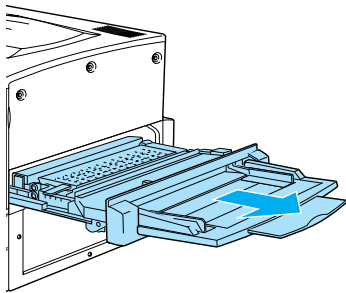

2. Lift the cover inside the paper path unit by its handle.

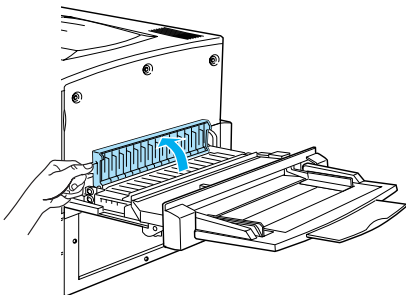

Note:

If paper is torn, be sure to remove all torn pieces.

4. Check if jammed paper is left at the bottom of the paper path unit. If you find any jammed paper, gently remove it with both hands.

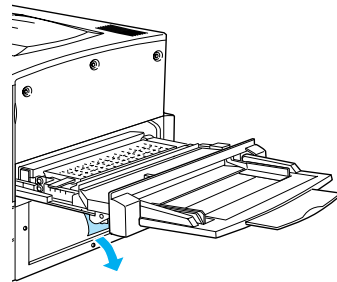

5. Lower the cover inside the paper path unit.

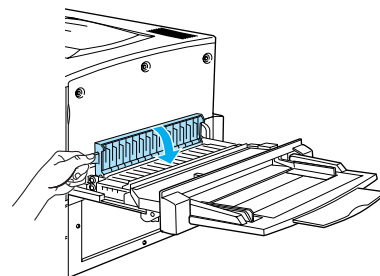

6. Push the paper path unit back into the printer firmly.

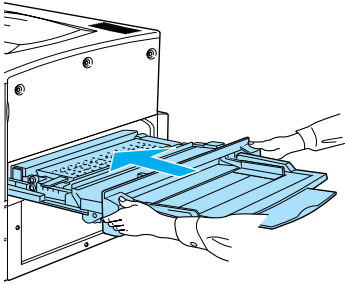

When the paper jam is cleared completely and the paper path unit (unit C) is pushed back into the printer, the jammed page's print data is automatically reprinted.

2. Gently remove the jammed paper with both hands. Be careful not to tear the jammed paper.

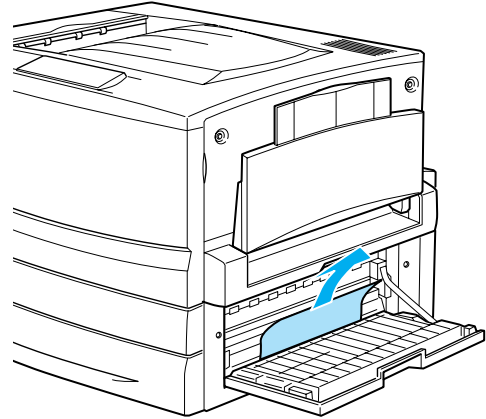

Paper Jam - Cover D (Jam D)

When paper is jammed at the paper cassette cover, the LCD panel displays the Jam D error message.

Follow these steps to clear paper jams in the paper cassette cover.

1. Open the paper cassette cover (cover D).

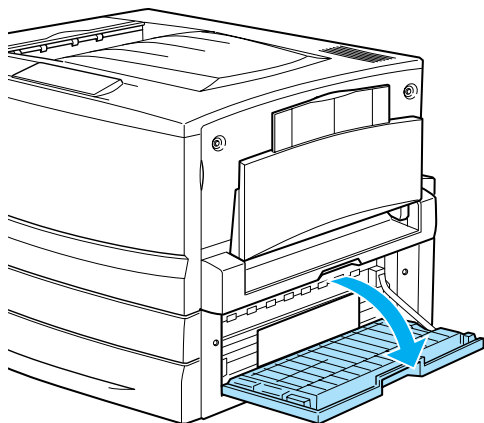

3. Close the paper cassette cover.

When the paper jam is cleared completely and the paper cassette cover (cover D) is closed, the jammed page's print data is automatically reprinted.

Note:

If you cannot find any jammed paper in this cover, check the optional Duplex Unit's inverter cover (cover F), then its main unit (unit G).

Paper Jam - Cover E (Jam E)

When paper is jammed at the side cover of the optional Large Capacity Paper Unit, the LCD panel displays the **Jam E** error message.

Follow these steps to clear paper jams in the optional Large Capacity Paper Unit.

1. Open the cover (cover E) on the right side of the optional Large Capacity Paper Unit.

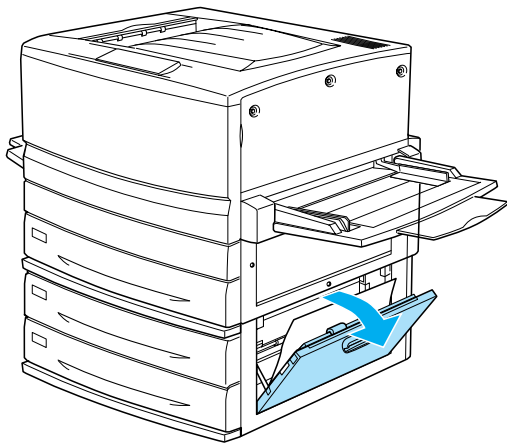

2. Gently remove the jammed paper with both hands. Be careful not to tear the jammed paper.

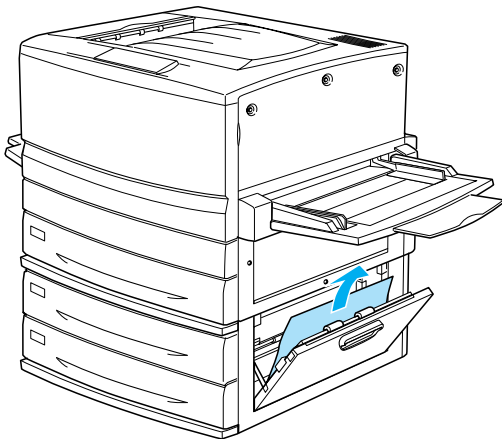

3. Close the cover.

When the paper jam is cleared completely and the cover on the right side of the Large Capacity Paper Unit (cover E) is pushed back into the printer, the jammed page's print data is automatically reprinted.

Paper Jam - Cover F (Jam F)

When paper is jammed at the optional Duplex Unit's inverter cover, the LCD panel displays the **Jam F** error message.

Follow these steps to clear paper jams in the Duplex Unit's inverter cover.

1. Open the Duplex Unit's inverter cover (cover F) on the left side of the printer.

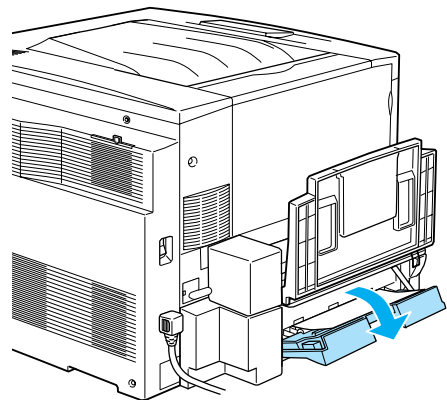

2. Gently remove the jammed paper inside the inverter cover.

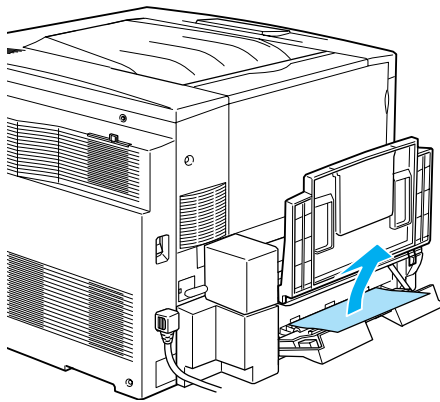

Note:

If paper is torn, be sure to remove all torn pieces.

3. Close the inverter cover.

When the paper jam is cleared completely and the Duplex Unit's inverter cover (cover F) is closed, the jammed page's print data is automatically reprinted.

Note:

If you cannot find any jammed paper in this cover, check the paper cassette cover (cover D), then the optional Duplex Unit's main unit (unit G).

Paper Jam - Unit G (Jam G)

When paper is jammed at the optional Duplex Unit's main unit, the LCD panel displays the Jam G error message.

Follow these steps to clear paper jams in the optional Duplex Unit's main unit.



Caution:

Be sure to pull out the Duplex Unit's main unit after checking if the jammed paper is in the paper cassette cover (cover D) or the Duplex Unit's inverter cover (cover F). If you pull out the main unit first, the paper jam may occur.

1. Pull the main unit of the optional Duplex Unit out until it stops.

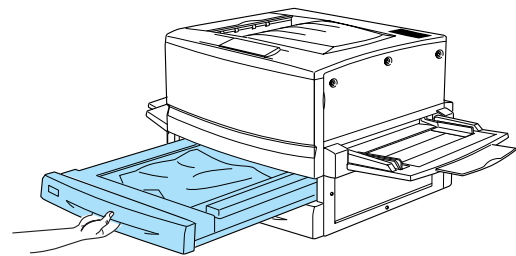

2. Gently remove the jammed paper with both hands. Be careful not to tear the jammed paper.

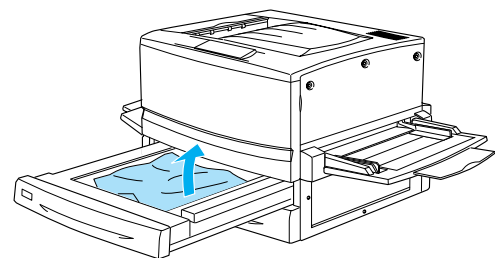

Note:

If paper is torn, be sure to remove all torn pieces.

3. Push the main unit of the Duplex Unit's main unit back into the printer.

When the paper jam is cleared completely and the Duplex Unit's main unit (unit G) is pushed back into the printer, the jammed page's print data is automatically reprinted.

Removing the main unit

If you cannot remove the jammed paper using the previous procedures, remove the Duplex Unit's main unit.

Follow the instruction below to remove the Duplex Unit's main unit.

Push the main unit slightly backward, then remove the main unit by pulling it toward you while pushing down both levers.

