

# EPSON

Color Ink Jet Printer

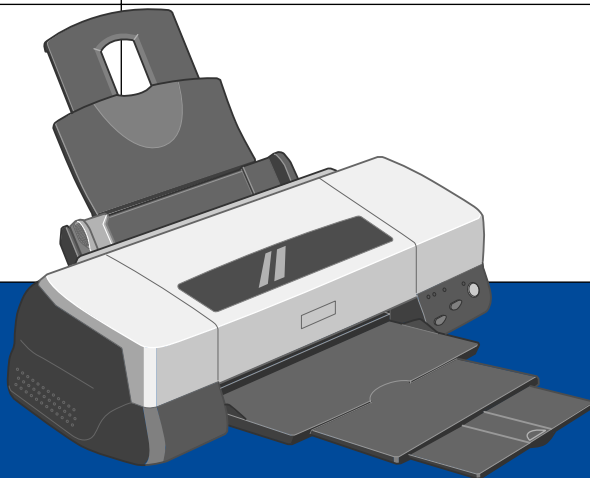

EPSON STYLUS™ PHOTO 2000P

*Daily Use*

4012157-00  
XXX

# Where to Find Information

## Setup Guide

This guide will help you set up and begin using your printer. It includes information on setting up your printer and installing the printer software.

## Daily Use Guide

This guide provides information on daily printer operation. It also contains troubleshooting tips and customer support information.

## Online Guides included on the CD-ROM

The guides on the CD-ROM included with your printer will help you learn more about your printer. To view these guides, you must have a Web browser installed on your computer. For more information on using this CD-ROM, see the included ***CD-ROM Booklet***.

***Reference Guide*** Provides detailed information about printer software settings, printing on special paper, maintenance, and problem solving.

All rights reserved. No part of this publication may be reproduced, stored in a retrieval system, or transmitted in any form or by any means, electronic, mechanical, photocopying, recording, or otherwise, without the prior written permission of SEIKO EPSON CORPORATION. The information contained herein is designed only for use with this EPSON printer. EPSON is not responsible for any use of this information as applied to other printers.

Neither SEIKO EPSON CORPORATION nor its affiliates shall be liable to the purchaser of this product or third parties for damages, losses, costs, or expenses incurred by the purchaser or third parties as a result of: accident, misuse, or abuse of this product or unauthorized modifications, repairs, or alterations to this product, or (excluding the U.S.) failure to strictly comply with SEIKO EPSON CORPORATION's operating and maintenance instructions.

SEIKO EPSON CORPORATION shall not be liable for any damages or problems arising from the use of any options or any consumable products other than those designated as Original EPSON Products or EPSON Approved Products by SEIKO EPSON CORPORATION.

SEIKO EPSON CORPORATION shall not be held liable for any damage resulting from electromagnetic interference that occurs from the use of any interface cables other than those designated as EPSON Approved Products by SEIKO EPSON CORPORATION.

EPSON is a registered trademark and EPSON Stylus is a trademark of SEIKO EPSON CORPORATION.

Microsoft and Windows are registered trademarks of Microsoft Corporation.

*General Notice: Other product names used herein are for identification purposes only and may be trademarks of their respective owners. EPSON disclaims any and all rights in those marks.*

Copyright © 2000 by SEIKO EPSON CORPORATION, Nagano, Japan.



**Printed on Recycled Paper.**



---

# Contents

<b>Safety Instructions</b> .....	<b>1</b>
Important Safety Instructions .....	1
A Few Precautions .....	2
ENERGY STAR Compliance .....	5
For United Kingdom Users .....	5
Warnings, Cautions, and Notes .....	7
<b>Printer Parts and Functions</b> .....	<b>8</b>
Printer Parts and Control Panel Functions .....	8
<b>Loading Special Paper, Envelopes, Other Media</b> ..	<b>10</b>
Loading Special Paper and Other Media .....	10
Loading Envelopes .....	11
<b>Printing with Windows</b> .....	<b>13</b>
Printer Software Introduction .....	13
Making Changes to Printer Settings .....	14
Previewing Your Printout .....	21
Getting Information Through Online Help .....	24
<b>Printing with Macintosh</b> .....	<b>26</b>
Printer Software Introduction .....	26
Making Changes to Printer Settings .....	26
Previewing your printout .....	32
<b>Replacing Ink Cartridges</b> .....	<b>35</b>
<b>Maintenance</b> .....	<b>44</b>
Checking the Print Head Nozzles .....	44
Cleaning the Print Head .....	46
Aligning the Print Head .....	49

**Troubleshooting . . . . . 51**  
Correcting USB Problems . . . . . 51  
Error Indicators . . . . . 55  
Typical Problems and Solutions . . . . . 57  
Cancelling Printing . . . . . 59  
Where to Get Help . . . . . 61

**Options and Consumable Products . . . . . 68**

# ***Safety Instructions***

---

## ***Important Safety Instructions***

Read all of these instructions before using your printer. Also be sure to follow all warnings and instructions marked on the printer.

- Do not block or cover the openings in the printer's cabinet. Do not insert objects through the slots.
- Do not spill liquid on the printer.
- Use only the type of power source indicated on the printer label.
- Connect all equipment to properly grounded power outlets. Avoid using outlets on the same circuit as photocopiers or air control systems that regularly switch on and off.
- Avoid electrical outlets controlled by wall switches or automatic timers.
- Keep the entire computer system away from potential sources of electromagnetic interference, such as loudspeakers or the base units of cordless telephones.
- Do not use a damaged or frayed power cord.
- If you use an extension cord with the printer, make sure the total ampere rating of the devices plugged into the extension cord does not exceed the cord's ampere rating. Also, make sure the total ampere rating of all devices plugged into the wall outlet does not exceed the wall outlet's ampere rating.
- Do not attempt to service the printer yourself.

- ❑ Unplug the printer and refer servicing to qualified service personnel under the following conditions:

The power cord or plug is damaged; liquid has entered the printer; the printer has been dropped or the cabinet damaged; the printer does not operate normally or exhibits a distinct change in performance.

- ❑ If you use the printer in Germany, observe the following:

To provide adequate short-circuit protection and over-current protection for this printer, the building installation must be protected by a 16 Amp circuit breaker.

Bei Anschluß des Druckers an die Stromversorgung muß sichergestellt werden, daß die Gebäudeinstallation mit einem 16 A-Überstromschalter abgesichert ist.

---

## ***A Few Precautions***

Take note of the following when using the printer, handling the ink cartridges, or choosing a location for the printer.

### ***When using the printer***

- ❑ Do not put your hand inside the printer or touch the ink cartridges during printing.
- ❑ Do not attempt to remove the paper by hand. Please wait for the paper to be ejected automatically.
- ❑ Do not move the print head by hand; otherwise, you may damage the printer.



- ❑ Always turn the printer off using the ⏻ power button. When this button is pressed, the ⏻ power light flashes briefly and then goes off. Do not unplug the printer or turn off the power to the outlet until the ⏻ power light stops flashing.
- ❑ Before transporting the printer, make sure the print head is in the home (far right) position and the ink cartridges are in place.

## ***When handling the ink cartridges***

- ❑ Keep ink cartridges out of the reach of children. Do not allow children to drink from or otherwise handle the cartridges.
- ❑ Be careful when you handle the used ink cartridges, as there may be some ink around the ink supply port. If ink gets on your skin, wash the area thoroughly with soap and water. If ink gets in your eyes, flush them immediately with water. If discomfort or vision problems remain after a thorough flushing, see a doctor immediately.
- ❑ Do not shake an ink cartridge; this can cause leakage.
- ❑ Install the ink cartridge immediately after you remove it from its package. If you leave a cartridge unpacked for a long time before using it, normal printing may not be possible.
- ❑ Do not use an ink cartridge beyond the date printed on the cartridge carton: otherwise, it may result in reduced print quality. For best results, use up the ink cartridges within six months of first installing them.
- ❑ Do not touch the green IC chip on the side of the cartridge. This may inhibit normal operation and printing.
- ❑ Do not remove the green IC chip from the side of the cartridge. If you install ink cartridges without an IC chip, the printer may be damaged.

- ❑ Do not dismantle the ink cartridges. Doing so can damage the print head.
- ❑ After bringing an ink cartridge inside from a cold storage site, allow it to warm up at room temperature for at least three hours before using it.
- ❑ Store ink cartridges in a cool, dark place.
- ❑ For each ink cartridge, the IC chip keeps track of a variety of cartridge-related information, such as the amount of ink remaining, so that a cartridge may be removed and reinserted freely. However, each time the cartridge is inserted, some ink from both the black and color ink cartridges is consumed because the printer checks for reliability.
- ❑ If you remove an ink cartridge for later use, be sure to protect the ink supply area from dirt and dust. Store it in the same environment as the printer. Be sure to store the cartridge with the EPSON label facing up. Note that there is a valve in the ink supply port, making covers or plugs unnecessary, but care is needed to prevent the ink from staining items that the cartridge touches. Do not touch the ink supply port of the cartridge or the surrounding area.
- ❑ EPSON recommends that you store unopened ink cartridge packages in the upright position.

### ***When choosing a place for the printer***

- ❑ Place the printer on a flat, stable surface that is larger than the printer. The printer will not operate properly if it is tilted or at an angle.
- ❑ Avoid places subject to rapid changes in temperature and humidity. Also, keep the printer away from direct sunlight, strong light, or heat sources.
- ❑ Avoid places subject to shocks and vibrations.

- ❑ Leave enough room around the printer to allow for sufficient ventilation.
- ❑ Place the printer near a wall outlet where the plug can be easily unplugged.
- ❑ Do not place the printer in a dusty area.

***Note for French-speaking users:***

*Placez l'imprimante près d'une prise de contact où la fiche peut être débranchée facilement.*

---

## **ENERGY STAR Compliance**



As an ENERGY STAR Partner, EPSON has determined that this product meets the ENERGY STAR guidelines for energy efficiency.

The International ENERGY STAR Office Equipment Program is a voluntary partnership with the computer and office equipment industry to promote the introduction of energy-efficient personal computers, monitors, printers, fax machines, and copiers in an effort to reduce air pollution caused by power generation.

---

## ***For United Kingdom Users***

### ***Use of options***

EPSON (UK) Limited shall not be liable against any damages or problems arising from the use of any options or consumable products other than those designated as Original EPSON Products or EPSON Approved Products by EPSON (UK) Limited.

## Safety information



### **Warning:**

*This appliance must be earthed. Refer to the rating plate for voltage and check that the appliance voltage corresponds to the supply voltage.*

### **Important:**

The wires in the mains lead fitted to this appliance are coloured in accordance with the following code:

Green and yellow — Earth

Blue — Neutral

Brown — Live

### **If you have to fit a plug:**

As the colours of the mains lead of this appliance may not match coloured markings used to identify the terminals in a plug, please proceed as follows:

The green and yellow wire must be connected to the terminal in the plug which is marked with the letter E or the earth symbol ( $\perp$ ).

The blue wire must be connected to the terminal in the plug marked with the letter N.

The brown wire must be connected to the terminal in the plug marked with the letter L.

If damage occurs to the plug, replace the cord set or consult a qualified electrician.

Replace fuses only with a fuse of the correct size and rating.

---

## **Warnings, Cautions, and Notes**



### **Warnings**

*must be followed carefully to avoid bodily injury.*



### **Cautions**

*must be observed to avoid damage to your equipment.*

### **Notes**

*contain important information and useful tips on the operation of your printer.*



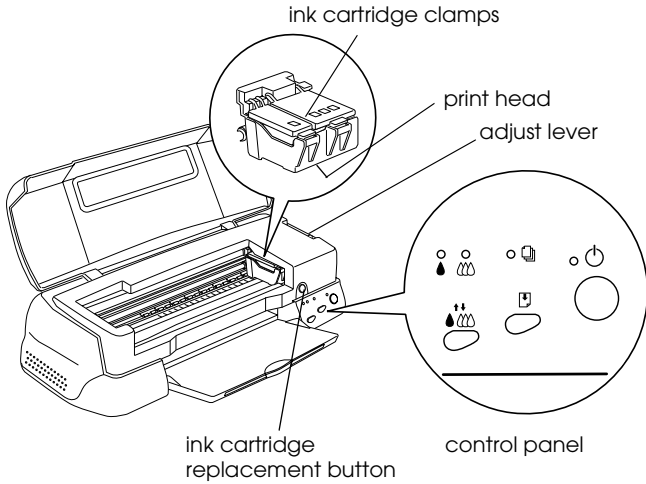
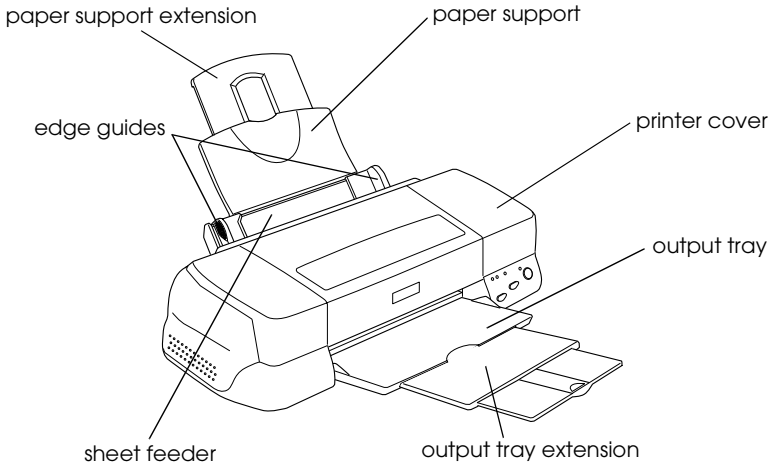

# Printer Parts and Functions

---





## Printer Parts and Control Panel Functions



## Buttons

Button	Function
 power	<p>Turns the printer on and off.</p> <p>Clears the printer's memory if pressed twice while the power is on.</p>
 load/eject	<p>Loads or ejects paper if pressed and released within 2 seconds.</p> <p>Resumes printing if pressed and released after a paper out error.</p>
 cleaning	<p>Performs print head cleaning if held for 3 seconds when the  black or  color ink out light is off.</p>
Ink cartridge replacement	<p>Charges ink to the print head when you replace the ink cartridges (this orange button is located under the printer cover, not in the control panel).</p>

## Lights

Light	Description
 power	<p>On when the printer is on.</p> <p>Flashing when printer is receiving data, printing, replacing an ink cartridge, charging ink, or cleaning the print head.</p>
 paper out	<p>On when the printer is out of paper. Load paper in the sheet feeder, then press the  load/eject button to resume printing.</p> <p>Flashing when the paper is jammed. Take all of the paper out of the feeder, then reload the paper. If the light continues to flash, turn off the printer and gently pull all the paper out of the printer.</p>
 black ink out	<p>On when the black ink cartridge is empty. Replace the black ink cartridge (T015).</p> <p>Flashing when the black ink cartridge is nearly empty.</p>
 color ink out	<p>On when the color ink cartridge is empty. Replace the color ink cartridge (T016).</p> <p>Flashing when the color ink cartridge is nearly empty.</p>

# Loading Special Paper, Envelopes, and Other Media

---

## Loading Special Paper and Other Media

When loading special media distributed by EPSON, read the instruction sheets packed with the media first and keep the following points in mind. For more details on using these kinds of media, see “Paper Handling” in the online *Reference Guide*.

- ❑ Make sure the printable side of the paper is facing up when loading media into the sheet feeder. See the instruction sheets packed with the media to determine which side is the printable surface. Some media have cut corners to help identify the correct loading direction, as shown in the illustration.

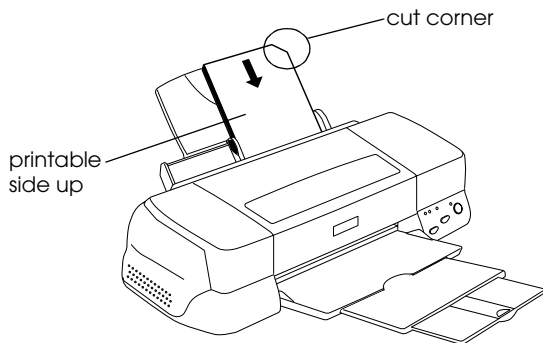

- ❑ Make sure the paper stack fits under the arrow mark located on the inside surface of the left edge guide.



- ❑ The loading capacity for EPSON special media is explained below.

Glossy Paper - Photo Weight	One sheet at a time.
Archival Matte Paper	One sheet at a time. Up to 20 sheets at a time for A4 size paper.
Premium Semigloss Photo Paper	One sheet at a time.

---

## **Loading Envelopes**

When printing on envelopes, please note the following:

- ❑ You can load up to 10 envelopes into the sheet feeder.

**Note:**

*The folding quality and thickness of envelopes varies widely. If the total thickness of the stack of envelopes exceeds 10 mm, press each envelope in the stack flat before loading.*

- ❑ Set the adjust lever to the “+” position. To do this, open the printer cover and reposition the lever.

**Note:**

- ❑ *Return the adjust lever to the “0” position, which is the normal position, after you finish printing on envelopes. Leaving the lever in the “+” position may cause gaps to appear in images printed on other media.*
- ❑ *When the adjust lever is in the “+” position, make sure the High Speed setting in the printer driver’s Advanced dialog box is off. To turn this option off, you may also need to change the Print Quality setting.*

- ❑ Load envelopes flap edge first with the flap side down, as shown in the illustration.

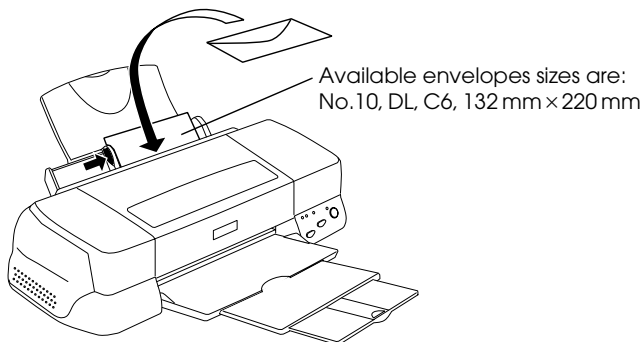

- ❑ Do not use envelopes that are curled or folded. Make sure to flatten the envelope flaps before loading. Also avoid using envelopes that are too thin; they may curl during printing.
- ❑ Select Plain Paper as the Media Type setting in the printer driver.

# Printing with Windows

---

## **Printer Software Introduction**

The printer software which comes with your printer includes a printer driver and printer utilities. The printer driver lets you choose from a wide variety of settings to get the best results from your printer. The printer utilities help you check the printer and keep it in top operating condition.

## **Getting more information**

For information on using the printer driver, see “Making Changes to Printer Settings” on page 14.

For information on using the printer utilities, see “Using the Printer Utilities” in the online *Reference Guide*.

### **Note:**

*The specific features available in the printer software vary depending on the version of Windows you are using.*

Online help provides more information about the printer software. See “Getting Information Through Online Help” on page 24 for instructions on accessing help.

## **Accessing the printer software**

You can access the printer software from most Windows applications, or from the Windows Start menu (Windows 98, 95 and NT 4.0).

When you access the printer software from a Windows application, the settings you make apply only to the application you are using.

When you access the printer software from the Start menu, the settings you make apply to all of your Windows applications.

### ***From Windows applications***

Follow the steps below to access the printer software.

1. From the File menu, click Print or Print Setup.
2. In the dialog box that appears, click Printer, Setup, Options, or Properties. (Depending on your application, you may need to click a combination of these buttons.) The printer driver opens.

### ***From the Windows Start menu***

Follow the steps below to access the printer software.

1. Click Start, point to Settings, then click Printers.
2. For Windows 98 and 95, select your printer, then click Properties on the File menu. For Windows NT 4.0, select your printer, then click Document Defaults on the File menu. The printer driver opens.

---

## ***Making Changes to Printer Settings***

The printer driver features the following menus and settings.

Main menu: Media Type, Ink, Mode

Paper menu: Paper Size, Copies, Orientation, Paper Source, Printable Area

Layout menu: Reduce/Enlarge, Multi-Page, Watermark

The Mode settings on the Main menu are arranged to give you four levels of control over the printer driver, as explained below.

<b>Automatic</b>	This mode provides the quickest and easiest way to start printing. See "Using the Automatic mode" on page 17.
<b>PhotoEnhance</b>	This mode lets you choose from a variety of image-correction settings specially designed for photos. See "Using the PhotoEnhance mode" on page 18.
<b>Custom</b>	This mode lets you choose from a list of ready-made or personalized settings suited to the kind of document you want to print. When Custom is selected, the Advanced button is enabled, allowing you access to the Advanced dialog box. See "Using the Custom mode" on page 19.
<b>Advanced</b>	This button opens the Advanced dialog box, where you can make detailed settings to fit your individual needs. From the Advanced dialog box, you can add your personalized settings to the Custom Settings list.

In addition to making comprehensive Mode settings that affect overall print quality, you can also modify individual aspects of your printout using the Paper and Layout menus. For more information about the Paper and Layout menus, see your online *Reference Guide*.

## ***Making the Media Type setting***

The Media Type setting determines what other settings are available, so you should always make this setting first.

On the Main menu, select the Media Type setting that matches the media which is loaded in the printer. To find out what Media Type you are using, find your media in the list below, and refer to the corresponding Media Type under which it is grouped (shown in larger type). For some media, there are several Media Type settings to choose from.

## Plain Paper

Plain paper

Envelopes

## Glossy Paper - Photo Weight

EPSON Glossy Paper - Photo Weight (Super A3)	S041347
---	---------

## Archival Matte Paper

EPSON Archival Matte Paper (Super A3/B)	S041339
	S041340

## Premium Semigloss Photo Paper

EPSON Premium Semigloss Photo Paper (Super A3/B)	S041327
	S041328

EPSON Premium Semigloss Photo Paper (4" × 26")	S041329
---	---------

EPSON Premium Semigloss Photo Paper (100mm × 8M)	S041330
---	---------

**Note:**

*The availability of special media varies by location.*

## Using the Automatic mode

When Automatic is selected as the Mode setting on the Main menu, the printer driver takes care of all detailed settings based on the current Media Type and Ink settings. To make the Ink setting, select **Color** to print in color, or **Black** to print in black-and-white or grayscale. To make the Media Type setting, see “Making the Media Type setting” on page 15.

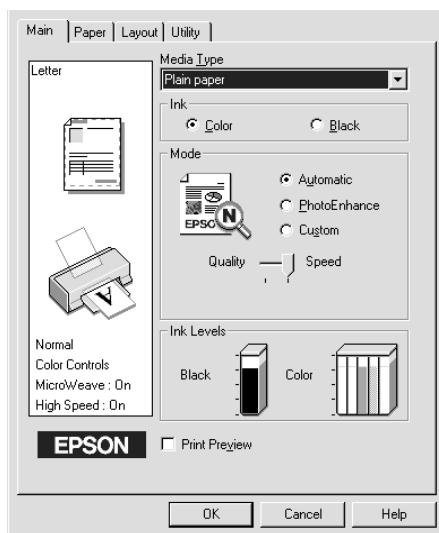

### Note:

- ❑ Depending on the media selected in the Media Type list (while Automatic is selected), a slider appears under the Custom radio button that lets you choose between Quality and Speed settings. Select Quality when print quality is more important than speed.
- ❑ Most Windows applications feature paper size and page layout settings that override similar settings on the printer driver. If your application does not support these settings, verify the settings on the printer driver's Paper menu.

## Using the PhotoEnhance mode

The PhotoEnhance mode provides a variety of image-correction settings that you can apply to your photo images before printing. PhotoEnhance does not affect your original data.



### Note:

- This mode is only available when printing 16-, 24-, and 32-bit color data.
- Printing with PhotoEnhance selected may increase the time required for printing, depending on your computer system and the amount of data contained in your image.
- Do not print using PhotoEnhance mode if Roll Paper is selected as the Paper Source on the Paper menu.

You can select from the following PhotoEnhance settings.

<b>Standard</b>	This setting provides standard image correction for most photos. Try this first.
-----------------	--



<b>People</b>	This setting is best for photos of people.
<b>Nature</b>	This setting is best for outdoor scenery such as mountains, sky, and oceans.
<b>Soft Focus</b>	This setting makes your photos look as if they were taken with a soft-focus lens.
<b>Sepia</b>	This setting applies a sepia tone to your photos.

Selecting PhotoEnhance also enables the Digital Camera Correction check box. Select this check box when you are printing photos taken with a digital camera to give your printed images the smooth, natural appearance of photographs taken with a film camera.

## Using the Custom mode

The Custom mode offers ready-made settings designed for printing text and graphs and for applying a color-matching method. You can also create and save your own custom settings.



You can select from the following ready-made settings.

<b>Text/Graph</b>	This setting is good for printing presentation documents such as graphs and charts.
<b>Draft</b>	This setting is best for printing drafts of text.
<b>ICM</b> (For Windows 95 and 98)	This setting automatically adjusts the printout colors to match the colors on your screen. ICM stands for Image Color Matching.
<b>sRGB</b>	This setting is best for color matching with other sRGB devices.

When you select a Custom setting, other settings such as Print Quality, and Color Adjustment are made automatically. Changes to these settings are reflected in the display on the left side of the Main menu.

Follow the steps below to select a Custom setting.

1. Select Custom as the Mode setting on the Main menu.
2. Click anywhere in the list box to open it, then select the most appropriate setting for the type of document or image you wish to print.
3. Before printing, be sure to verify the Media Type and Ink settings, as they may be affected by the Custom setting you select. See “Making the Media Type setting” on page 15.

---

## Previewing Your Printout



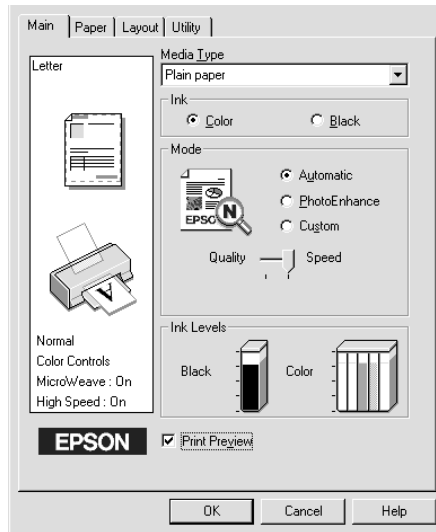

Select the Print Preview check box on the Main menu to see a preview of your document before printing.

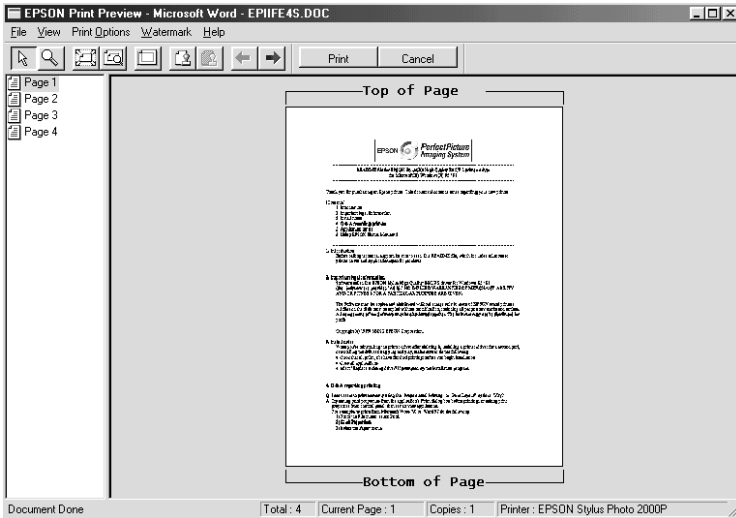





When you send a print job to the printer, the Print Preview window opens, allowing you to make changes before printing.



The Preview dialog box contains several icon buttons which you can use to perform the following functions:



	Drag 'n' drop	Clicking this button lets you select and move watermarks.
	Zoom	Clicking this button enlarges or reduces the size of the previewed page.
	Fit-to-screen	Clicking this button scales the previewed page so that it fits the size of the window. Select this option if you want to see the entire page at one time.
	Maximum zoom	Clicking this button displays the previewed page at the maximum possible zoom ratio.

	Printable area on/off	Clicking this button displays a rectangle on the page being previewed. This rectangle is the printable area for the page. The printer cannot print anything which is outside of this rectangle. Press the icon button again to turn this feature off.
	Watermark	Clicking this button opens the watermark settings dialog box, where you can change any of the current watermark settings.
	Reset watermark settings	Clicking this button returns all watermark settings to what they were when the Print Preview window was first opened. If nothing has been changed, this feature is not available.
	Previous page	Clicking this button displays the page previous to the one currently being previewed. If there is no previous page, this feature is not available.
	Next page	Clicking this button displays the next page in the document. If there is no next page, this feature is not available.

You can also manipulate the previewed document in the following ways:

- Select and preview individual pages.
- Reduce or enlarge the size of the preview.
- Select and print any or all pages.
- Apply watermarks. The watermark you select will appear in the previewed image. For detailed information on customizing watermarks, see “Printing a watermark on your document” in the online *Reference Guide*.

- ❑ Specify which pages in the document you would like printed using the Add and Remove features. To add or remove a page, you must first click the page icon in the list appearing on the left side of the preview window. Then add or remove it using the commands in the Print Options menu.

	Add page	Clicking this button will add the highlighted pages to the list of pages to be printed.
	Remove page	Clicking this button will remove the highlighted pages from the list of pages to be printed.

After you have previewed the document, click Print to print the document, or click Cancel to cancel printing.

---

## ***Getting Information Through Online Help***

Your printer software has an extensive online help feature, which provides you with instructions on printing, making printer driver settings, and using printer utilities.

### ***Accessing help from your application***

Open the File menu and choose Print or Print Setup. Then click Printer, Setup, Options, or Properties. (Depending on your application, you may need to click a combination of these buttons.) Click Help at the bottom of the Main, Paper, Layout, and Utility menus for help related to the items on that menu.

For Windows 98, 95, and NT 4.0, you can get specific help related to any item on a menu by right-clicking the item, then clicking the What's This? command.

## ***Accessing help from the Windows Start menu***

Click the Start button, point to Programs and Epson (for Windows 98 and 95) or EPSON Printers (for Windows NT 4.0), then click EPSON Stylus Photo 2000P Help. The help contents window opens.

# Printing with Macintosh

---

## Printer Software Introduction

The printer software which comes with your printer includes a printer driver and printer utilities. The printer driver lets you choose from a wide variety of settings to get the best results from your printer. The printer utilities help you check the printer and keep it in top condition.

For information on using the printer driver, see “Making Changes to Printer Settings” on page 26.

For information on using the printer utilities, see “Using the Printer Utilities” in the online *Reference Guide*.

You can also get more information about the printer software by clicking the help icon in any of the dialog boxes in the printer driver.



---

## Making Changes to Printer Settings

You will find the printer driver settings in the following dialog boxes.

- Print dialog box (click Print on the File menu of your application or click Options in the Page Setup dialog box)
- Page Setup dialog box (click Page Setup on the File menu of your application)
- Layout dialog box (click the  Layout icon button in the Print dialog box)



- ❑ Background Printing dialog box (click the  Background Printing icon button located in the Print dialog box)
- ❑ Preview dialog box (click the  Preview icon button and then click Preview in the Print dialog box)

The Mode settings in the Print dialog box are arranged to give you four levels of control over the printer driver, as explained below.

<b>Automatic</b>	This mode provides the quickest and easiest way to start printing. See “Using the Automatic mode” on page 29.
<b>PhotoEnhance</b>	This mode lets you choose from a variety of image-correction settings specially designed for photos. See “Using the PhotoEnhance mode” on page 30.
<b>Custom</b>	This mode lets you choose from a list of ready-made or personalized settings suited to the kind of document you want to print. When Custom is selected, the Advanced button is enabled, allowing you to access the Advanced dialog box. See “Using the Custom mode” on page 31.
<b>Advanced</b>	This button opens the Advanced dialog box, where you can make detailed settings to fit your individual needs. From the Advanced dialog box, you can add your personalized settings to the Custom Settings list.

In addition to making comprehensive Mode settings that affect overall print quality, you can also modify individual aspects of your printout using the settings contained in the Page Setup and the Layout dialog boxes. For information on making Page Setup settings, see “Making the Page Setup settings” on page 114. For information on making Page Layout settings, see “Modifying the Page Layout” on page 120.

## ***Making the Media Type setting***

The Media Type setting determines what other settings are available, so you should always make this setting first.

In the Print dialog box, select the Media Type setting that matches the paper you loaded in the printer. To find out what Media Type you are using, find your media in the list below, and refer to the corresponding Media Type under which it is grouped (shown in larger type). For some media, there are several Media Type settings to choose from.

Plain Paper

Plain paper

Envelopes

Glossy Paper - Photo Weight

EPSON Glossy Paper - Photo Weight (Super A3)	S041347
---	---------

Archival Matte Paper

EPSON Archival Matte Paper (Super A3/B)	S041339
	S041340

Premium Semigloss Photo Paper

EPSON Premium Semigloss Photo Paper (Super A3/B)	S041327
	S041328

EPSON Premium Semigloss Photo Paper (4" × 26")	S041329
---	---------

EPSON Premium Semigloss Photo Paper (100mm × 8M)	S041330
---	---------

**Note:**

*The availability of special media varies by location.*

## Using the Automatic mode

When Automatic is selected as the Mode setting in the Print dialog box, the printer driver takes care of all detailed settings based on the current Media Type and Ink settings. To make the Ink setting, select Color to print in color, or Black to print in black-and-white or grayscale. To make the Media Type setting, see “Making the Media Type setting” on page 28.

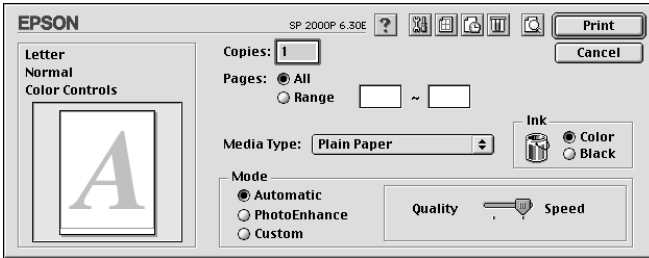

**Note:**

*Depending on the media you choose in the Media Type list (while Automatic is selected), a slider appears to the right of the Mode options that lets you choose between Quality and Speed settings. Select Quality when print quality is more important than speed.*

## Using the PhotoEnhance mode

The PhotoEnhance mode provides a variety of image-correction settings that you can apply to your photos before printing. PhotoEnhance does not affect your original data.

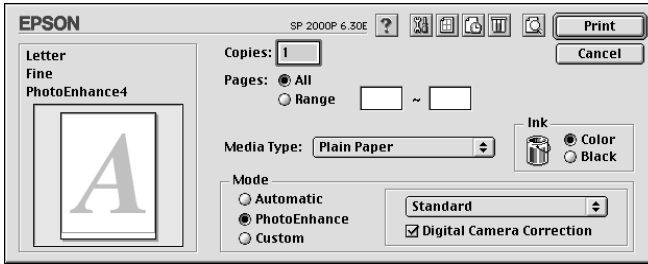

### Note:

- This mode is only available when printing 32-bit color data.
- Printing with PhotoEnhance selected may increase the time required for printing, depending on your computer system and the amount of data contained in your image.
- If you select Roll Paper as the Paper Source in the Page Setup dialog box, do not print your document using PhotoEnhance.

You can select from the following PhotoEnhance settings.

<b>Standard</b>	This setting provides standard image correction for most photos. Try this first.
<b>People</b>	This setting is best for photos of people.
<b>Nature</b>	This setting is best for outdoor scenery such as mountains, sky, and oceans.
<b>Soft Focus</b>	This setting makes your photos look as if they were taken with a soft-focus lens.
<b>Sepia</b>	This setting applies a sepia tone to your photos.

If you are printing photos taken with a digital camera, you can also select the Digital Camera Correction check box to give your printed images the smooth, natural appearance of photographs taken with a film camera.

## Using the Custom mode

The Custom mode offers ready-made settings designed for printing text and graphs and for applying a color-matching method. You can also create and save your own custom settings.

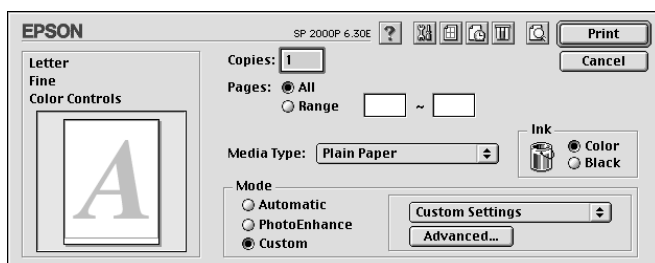

You can select from the following ready-made settings.

<b>Text/Graph</b>	This setting is good for printing presentation documents such as graphs and charts.
<b>Draft</b>	This setting is best for printing drafts of text.
<b>ColorSync</b>	This setting automatically adjusts printout colors to match colors on your screen.

When you choose a Custom setting, other settings such as Print Quality, and Color are made automatically. Changes to these settings are reflected in the display on the left side of the Print dialog box.

Follow the steps below to select a Custom setting.

1. Verify that the Media Type and Ink settings in the Print dialog box are correct. For details, see “Making the Media Type setting” on page 28.
2. Select the Custom radio button in the Print dialog box. This enables the Custom Settings list, located to the right of the Custom radio button.
3. From the Custom Settings list, select the most appropriate setting for the type of document or image you will print.





---

## ***Previewing your printout***

The Preview feature allows you to see how your document will look before actually printing it. Follow these steps to preview your document.

1. Make your printer driver settings.
2. Click the  Preview icon button in the Print dialog box. The Print button changes into a Preview button.

***Note:***

Use the  Preview icon button to switch between the  Print,  Preview, and  Save File modes. Click the icon to select the mode you want. For information on the Save File mode, see “Saving print data in files” on page 34.

- Click the Preview button. The Preview dialog box appears and displays a preview of your document.

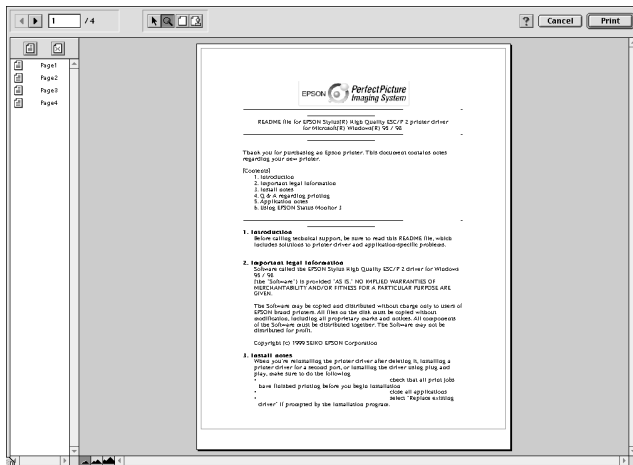

The Preview dialog box contains six icon buttons you can use to perform the following functions.

	Selection	Clicking this button lets you select, move, and resize watermarks.
	Zoom	Clicking this button enlarges or reduces the size of the previewed page.
	Margin Display/ Non-Display	Clicking this button displays or hides borderlines which indicate the printable area.
	Watermark Editing	Clicking this button opens the Watermark Edit box. This dialog box allows you to add watermarks to the document, and to change any of the current watermark settings.
	Add Page Remove Page	Clicking these buttons let you select or deselect the pages that you want to print from the list on the left side of the preview window.





- If you are satisfied with the previewed image, click Print.

If you are not satisfied with the appearance of the image, click Cancel. The Preview and Print dialog boxes close with the current print settings preserved. Open the Print dialog box again to make additional changes to the print settings.

## ***Saving print data in files***

You can save print data in a file by using the  Save File icon button in the Print dialog box. This feature lets you print the file at a later time simply by double-clicking the saved file. Follow these steps.

### **Note:**

Use the  Preview icon button to switch between the  Print,  Preview, and  Save File modes. Click the icon to select the mode you want.

1. Make your printer driver settings.
2. Click the  Preview icon button in the Print dialog box repeatedly until the Print button changes into the Save File button.
3. Click the Save File button.
4. Select the location where you want to save the file, then type a file name in the Save As box and click Save.

When you want to print the data, double-click the file to open EPSON Monitor 3. Click the  Resume button to send the data to the printer.







# Replacing Ink Cartridges

This printer uses ink cartridges equipped with IC chips. The IC chip accurately monitors the amount of ink used by each cartridge, so even if a cartridge is removed and later reinserted, all of its ink can be used. However, a small amount of black and color ink is consumed each time the cartridge is inserted because the printer automatically checks reliability.

Follow the instructions in this section to replace an ink cartridge using the printer's control panel or the status Monitor utility.

The printer's indicator lights will inform you when it is time to obtain a replacement ink cartridge and when it is time to replace an empty cartridge. You can also check ink levels and start the ink cartridge replacement procedure from your computer using the Status Monitor 3 utility. See the online *Reference Guide* for more information.

This table describes the status of the lights on your printer and the actions you need to take.

Lights	Action
	Obtain a replacement black ink cartridge (T015).
	Replace the empty black ink cartridge.
	Obtain a replacement color ink cartridge (T016).
	Replace the empty color ink cartridge.

● = on, ◌ = flashing

**Warning:**

- ❑ *Keep ink cartridges out of the reach of children. Do not allow children to drink from or otherwise handle the cartridges.*
  
- ❑ *Be careful when you handle the used ink cartridges, as there may be some ink around the ink supply port. If ink gets on your skin, wash the area thoroughly with soap and water. If ink gets into your eyes, flush them immediately with water. If discomfort or vision problems remain after a thorough flushing, see a doctor immediately.*

**Caution:**

- ❑ *EPSON recommends the use of genuine EPSON ink cartridges. Other products not manufactured by EPSON may cause damage to your printer not covered by EPSON's warranties.*
  
- ❑ *Leave the old cartridge installed in the printer until you have obtained a replacement; otherwise, ink remaining in the print head nozzles may dry out.*
  
- ❑ *Do not refill the ink cartridges. The printer calculates the amount of ink remaining using an IC chip on the ink cartridge. Even if the cartridge is refilled, the amount of ink remaining will not be recalculated by the IC chip and the amount of ink available for use will not change.*

**Note:**





- ❑ *You cannot continue printing with an empty ink cartridge installed, even if the other cartridge contains ink. Before printing, replace the empty cartridge.*
  
- ❑ *In addition to the ink used during printing, ink is consumed during the print head cleaning operation, during the self-cleaning cycle which is performed when the printer is turned on, and during ink charging when the ink cartridge is installed in the printer.*

For more information about ink cartridges, see “When handling the ink cartridges” on page 3.

To replace an ink cartridge using the orange ink cartridge replacement button, follow the steps below.

**Note:**

*You can also replace an ink cartridge from your computer using EPSON Status Monitor 3. Click the HOW TO button in the Status Monitor's Printer Status window, then follow the on-screen instructions.*

1. Make sure the printer is on. The  power light should be on, but not flashing. (Determine which cartridge needs to be replaced as indicated by the  black and  color ink out lights.)
2. Lower the output tray at the front of the printer, then open the printer cover.
3. Press the orange ink cartridge replacement button. The print head moves left to the ink cartridge replacement position, and the  power light begins flashing.

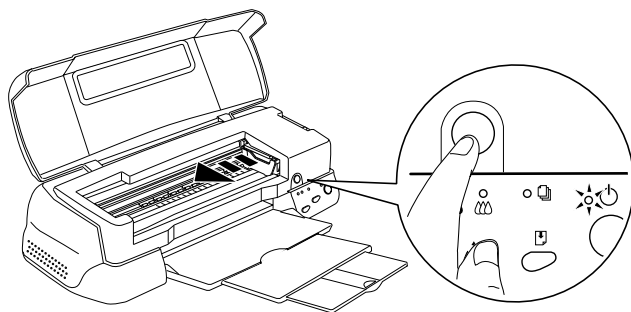

**Caution:**

*Do not move the print head by hand as this may damage the printer. Always press the orange ink replacement button to move it.*

4. Lift up the clamp that holds the cartridge you want to replace as far as it will go. The cartridge rises partly out of the cartridge holder.

The illustration shows color ink cartridge replacement. To replace the black ink cartridge, lift up only the smaller clamp on the left.

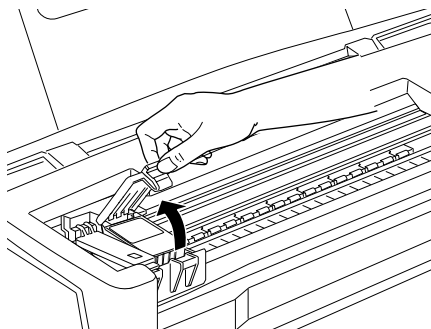

5. Lift the cartridge out of the printer and dispose of it properly. Do not take the used cartridge apart or try to refill it.

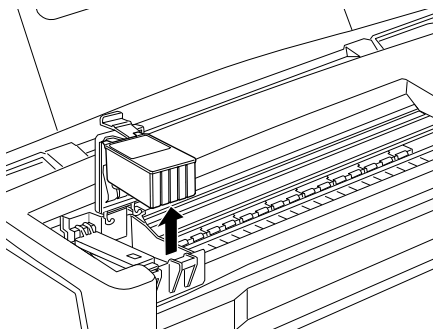

6. Remove the new ink cartridge from its protective bag. Next, remove only the yellow tape seal from the cartridge.

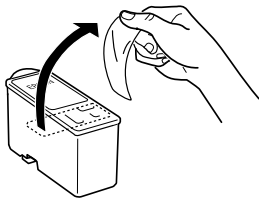

black ink cartridge (T015)

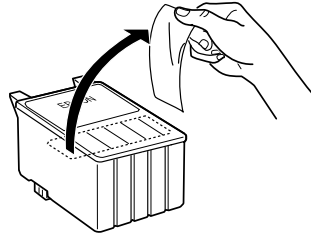

color ink cartridge (T016)

**Caution:**

- ❑ *You must remove the yellow tape seal from the cartridge before installing it; otherwise, the cartridge will become unusable and you will be unable to print.*
- ❑ *If you have installed an ink cartridge without removing the yellow tape seal, you must remove the cartridge and install a new one. Prepare the new cartridge by removing the yellow tape seal, then install it in the printer.*
- ❑ *Do not remove the EPSON label from the top of the cartridge; otherwise, the print head may become clogged and be unable to print.*
- ❑ *Do not remove the tape seal from the bottom of the cartridge; otherwise, ink will leak.*
- ❑ *Do not remove the green IC chip from the side of the cartridges. Installing a cartridge without an IC chip can damage the printer.*
- ❑ *Do not touch the green IC chip on the side of the cartridge. This can damage the ink cartridge.*
- ❑ *If you remove an ink cartridge for later use, be sure to protect the ink supply area from dirt and dust; store it in the same environment as the printer. Be sure to store the cartridge with the EPSON label facing up as shown in the picture below. Note that there is a valve in the ink supply port, making covers or plugs unnecessary, but care is needed to prevent the ink from staining items that the cartridge touches. Do not touch the ink cartridge ink supply port or surrounding area.*

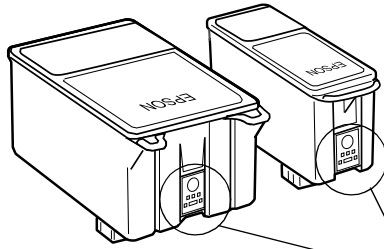

Do not touch this part.

7. Align the tabs on the ink cartridge so that they are resting on the tabs protruding from the base of the opened ink cartridge clamp. Do not apply excessive force to the cartridge.

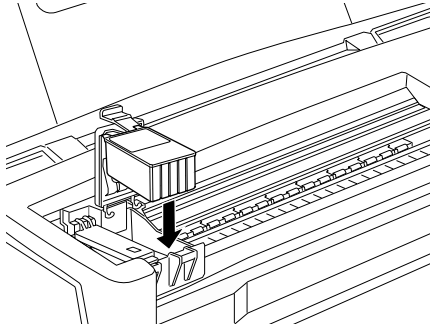



**Caution:**

*Make sure the ink cartridge tabs are not under the tabs protruding from the base of the opened ink cartridge clamp, as this could damage the clamp.*

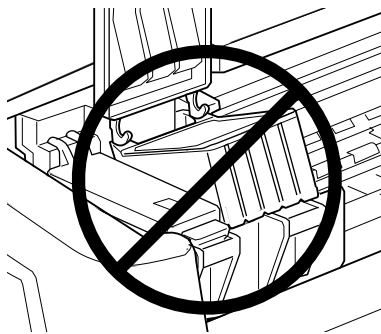

8. Press down on the ink cartridge clamp until it locks into place.

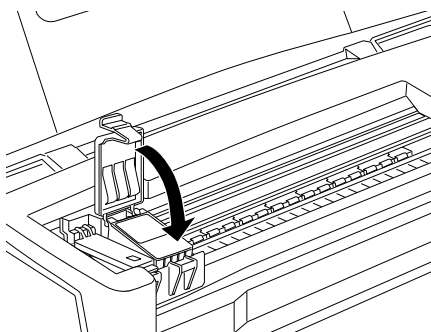

The illustration shows color ink cartridge replacement. To replace the black ink cartridge, replace only the cartridge held by the smaller clamp on the left.



**Caution:**

*Insert a new ink cartridge immediately after removing a used cartridge from the printer. If no cartridge is present, the print head may dry out and become unable to print.*



9. Press the orange ink cartridge replacement button. The printer moves the print head and begins charging the ink delivery system. This process takes about one minute to complete. When the ink charging process is finished, the printer returns the print head to its home position, the  power light stops flashing and stays on, and the black and  color ink lights come on.

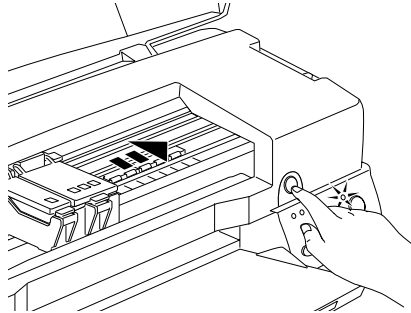

**Caution:**

*The  power light continues to flash while the printer performs the ink charging operation. Never turn off the printer while this light is flashing. Doing so can result in incomplete charging of ink.*

10. Close the printer cover.

# Maintenance

---

## Checking the Print Head Nozzles

If you find that the printed image is unexpectedly faint or colors in the printed image are missing, you may be able to identify the problem by checking the print head nozzles.

You can check the print head nozzles from your computer using the Nozzle Check utility in the printer software, or from the printer itself by using the printer's control panel buttons.

## Using the Nozzle Check utility

Follow the steps below to use the Nozzle Check utility.

**Note:**

*Do not use the Nozzle Check utility while printing is in progress; otherwise, your printout may be marred.*

### *For Windows users*

1. Make sure A4 or Letter size paper is loaded in the sheet feeder.
2. Click the Utility tab in the printer software, then click the Nozzle Check button.
3. Follow the instructions on your screen.



### *For Macintosh users*

1. Make sure A4 or Letter size paper is loaded in the sheet feeder.
2. Click the  Utility icon button in the Print or Page Setup dialog box, then click the Nozzle Check button.

3. Follow the instructions on your screen.

## ***Using the control panel buttons***

Follow the steps below to check the print head nozzles using the control panel buttons.

1. Turn off your printer.
2. Make sure that A4 or Letter size paper is loaded in the sheet feeder.
3. Hold down the  load/eject button (① in the illustration below) and press the  power button (② in the illustration below) to turn on the printer.

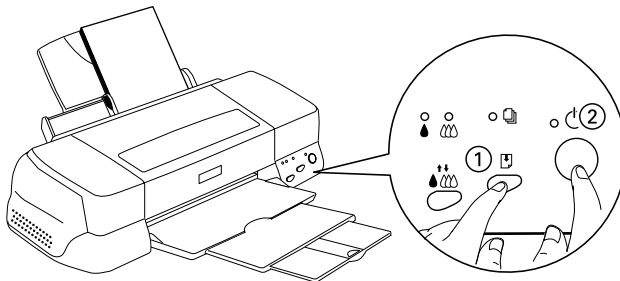

4. Release both buttons.

The printer prints an operation check page that includes your printer's ROM version information, the ink counter code, and a nozzle check pattern. Below are sample printouts.

Good sample



Print head needs to be cleaned

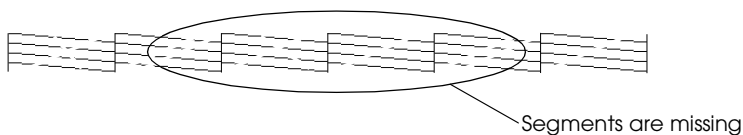

The above sample is in black and white, but the actual test prints in color (CMYK).

If the nozzle check page does not print satisfactorily (for example, if any segment of the printed lines is missing) there is a problem with the printer. This could be a clogged ink nozzle or a misaligned print head. See the next section for details on cleaning the print head. For information on aligning the print head, see "Aligning the Print Head" on page 49.



---

## ***Cleaning the Print Head***

If you find that the printed image is unexpectedly faint or colors in the printed image are missing, you may be able to solve these problems by cleaning the print head, which ensures that the nozzles are delivering ink properly.

You can clean the print head from your computer by using the Head Cleaning utility in the printer software, or from the printer itself by using the printer's control panel buttons.



**Note:**

- ❑ *Print head cleaning uses both color and black ink. To avoid wasting ink, clean the print head only if print quality declines. For example, clean the print head if the printout is blurry or the color is incorrect or missing.*
- ❑ *Use the Nozzle Check utility first to confirm that the print head needs to be cleaned. This saves ink.*
- ❑ *When the  black or  color ink out light is flashing or on, you cannot clean the print head. Replace the appropriate ink cartridge first.*
- ❑ *Do not start the Head Cleaning or Nozzle Check utility while printing is in progress; otherwise, your printout may be marred.*



## **Using the Head Cleaning utility**

Follow the steps below to use the Head Cleaning utility.

### *For Windows users*



1. Make sure that the printer is on and both the  black and  color ink out lights are off.

**Note:**

*If the  black or  color ink out light is flashing, you cannot clean the print head. Replace the appropriate ink cartridge first.*

2. Click the Utility tab in the printer software, then click the Head Cleaning button.
3. Follow the messages on your screen.



### *For Macintosh users*

1. Make sure that the printer is on, and the  black and  color ink out lights are off.



2. Click the  Utility icon button in the Print or Page Setup dialog box, then click the Head Cleaning button.
3. Follow the on-screen instructions.

## Using the control panel buttons

Follow the steps below to clean the print head using the control panel buttons.

1. Make sure that the  power light is on and that both the  black and  color ink out lights are off.

### **Note:**

*If the  black or  color ink out light is flashing or on, you cannot clean the print head.*

2. Hold down the  cleaning button for three seconds.

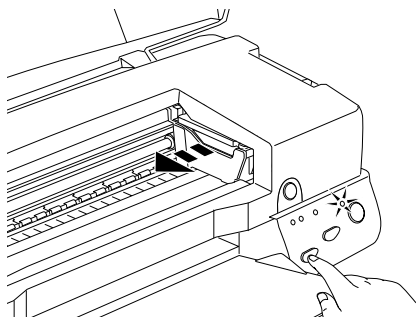

The printer starts cleaning the print head and the  power light begins flashing. Print head cleaning takes about thirty seconds to complete.



### **Caution:**

*Never turn off the printer while the  power light is flashing. Doing so may damage the printer.*

3. When the  power light stops flashing, print a nozzle check pattern to confirm that the head is clean and to reset the cleaning cycle.

If print quality hasn't improved after repeating this procedure four or five times, turn the printer off and leave it alone overnight. Then do the head cleaning again.

If the print quality still has not improved, one or both of your ink cartridges may be old or damaged and may need to be replaced. To replace an ink cartridge before it is empty, see "Replacing Ink Cartridges" in the online *Reference Guide*.

If print quality remains a problem after replacing the ink cartridges, contact your dealer.

**Note:**

*To maintain print quality, we recommend turning on the printer for at least one minute every month.*

---

## ***Aligning the Print Head***

If you notice a misalignment of vertical lines, you may be able to solve this problem using the Print Head Alignment utility in your printer software. Follow the directions in the appropriate section below.

**Note:**

*Do not start the Print Head Alignment utility while printing is in progress; otherwise, your printout may be marred.*

### *For Windows users*

1. Make sure A4 or Letter size Archival Matte Paper is loaded in the sheet feeder.
2. Click the Utility tab in the printer software, then click the Print Head Alignment button.

3. Follow the messages on your screen to align the print head.

*For Macintosh users*

1. Make sure A4 or Letter size Archival Matte Paper is loaded in the sheet feeder.
2. Click the  Utility icon button in the Print or Page Setup dialog box, then click the Print Head Alignment button.
3. Follow the messages on your screen to align the print head.



# ***Troubleshooting***

---

## ***Correcting USB Problems***

If you are having difficulty using your printer with a USB connection, refer to the information in this section.

### ***Make sure your computer is a Windows 98 pre-installed model***

Your computer must be a Windows 98 pre-installed model. You may not be able to install or run the USB printer driver on a computer which is not equipped with a USB port or which is upgraded from Windows 95 to 98.

For details about your computer, contact your dealer.

### ***Make sure that EPSON USB Printer Devices appears in the Device Manager menu***

If you canceled the plug-and-play driver installation before the procedure was completed, either the USB printer device driver or the printer driver may be incorrectly installed.

Follow the steps below to check the installation and reinstall the drivers.

1. Turn the printer on. Plug the USB cable into the printer and the computer.
2. Right-click the My Computer icon on your desktop, then click Properties.
3. Click the Device Manager tab.

If your drivers are correctly installed, EPSON USB Printer Devices should appear in the Device Manager menu.

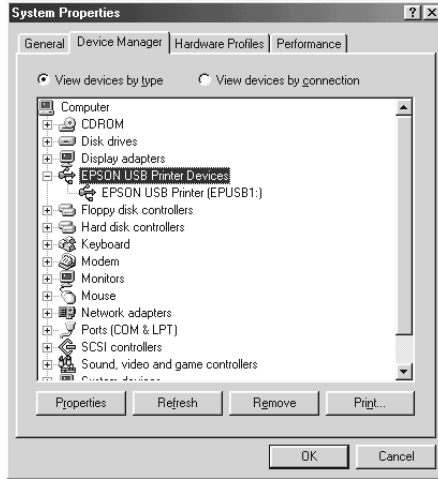

If EPSON USB Printer Devices does not appear in the Device Manager menu, click the plus (+) sign beside Other Devices to view the installed devices.



If USB Printer appears under Other Devices, the USB printer device driver is not installed correctly. If EPSON Stylus Photo 2000P appears, the printer driver is not installed correctly.

If neither USB Printer nor EPSON Stylus Photo 2000P appears under Other Devices, click Refresh or unplug the USB cable from the printer, then plug it into the printer again.

4. Under Other Devices, click USB Printer or EPSON Stylus Photo 2000P, then click Remove. Click OK.

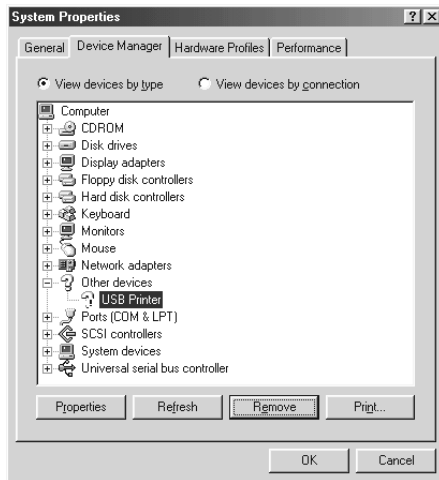

5. When the following dialog box appears, click OK. Then click OK to close the Properties window.



6. Turn off the printer and restart your PC. Then, reinstall the driver from the beginning, following the instructions in the *Setup Guide*.

## ***Printer does not work correctly with a USB cable***







If your printer does not work correctly with a USB cable, try one or more of these solutions:



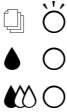

- ❑ Use the recommended USB cable as described in “System Requirements” in the online *Reference Guide*.
- ❑ If you use a USB hub, connect the printer to the first tier of the hub, or connect the printer to the computer’s USB port directly.
- ❑ For PCs, try reinstalling the USB printer device driver and the printer software. First, uninstall EPSON Printer Software using the Add/Remove Programs utility in the Control Panel, then uninstall EPSON USB Printer Devices. Next, reinstall the software as described in *Setup Guide*. If EPSON USB Printer Devices is not registered in the Add/Remove Programs list, access the CD-ROM and double-click epusbun.exe in the Win 9X folder. Then follow the on-screen instructions.

---

## Error Indicators

You can identify many common printer problems using the lights on your printer's control panel. If your printer stops working and the lights are on or flashing, use the following table of panel light patterns to diagnose the problem, then follow the recommended solutions.

Lights	Problem and Solution	
	<b>Paper out</b>	
	No paper is loaded in the printer.	Load paper in the sheet feeder, then press the  load/eject button. The printer resumes printing and the light goes out.
	<b>Paper jam</b>	
	Paper has jammed in the printer.	Press the  load/eject button. The printer ejects the jammed paper and then resumes printing. If the error is not cleared, open the printer cover and remove the jammed paper. Then reload the paper in the sheet feeder and press the  load/eject button. The printer resumes printing.
	<b>Ink low (black ink cartridge)</b>	
	The black ink cartridge is nearly empty.	Obtain a replacement black ink cartridge (T015).

	<b>Ink out (black ink cartridge)</b>	
	The black ink cartridge is empty or not installed.	Replace the black ink cartridge with a new one (T015). See "Replacing Ink Cartridges" on page 35.
	<b>Wrong cartridge (black ink cartridge)</b>	
	The installed black ink cartridge cannot be used with this printer.	Install an appropriate black ink cartridge (T015). See "Replacing Ink Cartridges" on page 35.
	<b>Ink low (color ink cartridge)</b>	
	The color ink cartridge is nearly empty.	Obtain a replacement color ink cartridge (T016).
	<b>Ink out (color ink cartridge)</b>	
	The color ink cartridge is empty or not installed.	Replace the color ink cartridge with a new one (T016). See "Replacing Ink Cartridges" on page 35.
	<b>Wrong cartridge (color ink cartridge)</b>	
	The installed color ink cartridge cannot be used with this printer.	Use an appropriate color ink cartridge (T016). See "Replacing Ink Cartridges" on page 35.
	<b>Carriage error</b>	
	The print head carriage is obstructed by jammed paper or other foreign material and cannot return to the home position.	Turn off the printer. Open the printer cover and remove any paper from the paper path by hand. Then turn the printer back on.  If the error is not cleared, contact your dealer.
	<b>Unknown printer error</b>	
	An unknown printer error has occurred.	Turn off the printer, and contact your dealer.

● = on, ○ = off, ◌ = flashing

---

## ***Typical Problems and Solutions***

Most printer problems have simple solutions. Find the problem in the list below and apply the recommended solution. For more information, see “Troubleshooting” in the online *Reference Guide*.

### ***Print quality problems***

If you are having print quality problems, try the solutions offered here.

#### *Horizontal banding*

Try one or more of these solutions:

- Make sure the printable side of the paper is face up in the sheet feeder.
- Run the Head Cleaning utility to clear any clogged ink nozzles.



#### *Vertical misalignment*

Try one or more of these solutions:

- Make sure the printable side of the paper is face up in the sheet feeder.
- Run the Print Head Alignment utility.
- Clear the High Speed check box in your printer driver. For instructions, see the printer driver’s online help for Windows. For Macintosh, see “Using the Advanced settings” in the online *Reference Guide*.

#### *Color gaps*

Try one or more of these solutions:

- ❑ Make sure your paper is not damaged, dirty, or too old.
- ❑ Run the Head Cleaning utility to clear any clogged ink nozzles.
- ❑ Check the  black and  color ink out lights. If a light is flashing, replace the ink cartridge. See “Replacing Ink Cartridges” on page 35.

### *Blurry or smeared printout*

Try one or more of these solutions:

- ❑ Make sure the printable side of the paper is face up in the sheet feeder.
- ❑ Make sure your paper is not damaged, dirty, or too old.
- ❑ Set the adjust lever to the “+” position, and make sure the Media Type setting in your printer driver is correct.

### *Printer rollers leave unwanted marks on your documents*

It may become necessary to clean the printer rollers in the following situations:

- ❑ When you use paper that is not distributed by EPSON.
- ❑ When you use EPSON special media that is not supported by this printer.
- ❑ When you print on the wrong side of the paper.
- ❑ When you use the printer in conditions that differ from the environment specified in the manual.
- ❑ When the printer rollers have not been cleaned recently.

See the online *Reference Guide* for cleaning the printer rollers.



## ***Paper feed or paper jam problems***

If the printer doesn't feed paper, feeds multiple pages, or the paper is jammed, remove and reload the stack of paper, then press the  load/eject button. You may need to wait for some time before the paper is ejected, depending on the amount of print data, the paper type, and the print quality setting. Also make sure of the following:

- The paper isn't old or creased.
- Paper isn't loaded above the arrow on the left edge guide.
- The edge guides are set correctly.
- The paper isn't too thin or rough. Use paper that meets the paper requirements for this printer. See the online *Reference Guide* for paper specifications.

---

## ***Cancelling Printing***

If the printouts are not what you expected and display incorrect or garbled characters or images, you may need to cancel printing. To cancel printing, follow the instructions below.

## For Windows 98, 95 and NT 4.0

When you send a print job to the printer, the Progress Meter appears on your computer screen.

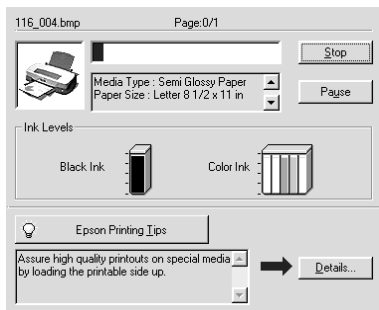

Click the Stop button to cancel printing.

## For Macintosh

The procedure for canceling printing for Macintosh varies, depending upon whether background printing is on or off.

### When background printing is on

1. Click EPSON Monitor3 on the application menu. EPSON Monitor3 opens.



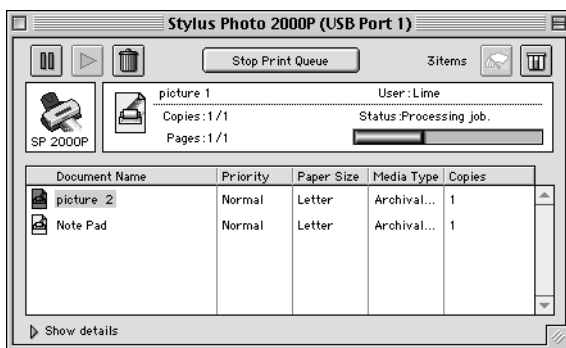

2. Select the print job that you wish to cancel in the Document Name list, then click the  Stop icon button to cancel the print job.



3. Press the  power button to turn off the printer.

### ***When background printing is off***

1. Hold down the  command key on your keyboard and press the period (.) key to cancel the print job.
2. Press the  power button to turn off the printer.

---

## ***Where to Get Help***

If your printer is not operating properly and you cannot solve the problem using the troubleshooting information in your printer documentation, contact customer support services for assistance.

Customer support will be able to help you much more quickly if you give them the following information:

- Serial number of your printer  
(The serial number label is on the back of the printer)
- Printer model

- Brand and model of your computer
- Printer software version  
(Click About in your printer driver)
- Windows version you are using
- Software application(s) you normally use with your printer  
and their version number(s)

### ***For United Kingdom and the Republic of Ireland users***

If you purchased your product in the UK or the Republic of Ireland, EPSON (UK) LTD provides a range of customer services and technical support.

#### *Support Via the World Wide Web*

- For information on the latest EPSON products, software drivers, on-line user guides and answers to frequently asked questions:  
<http://www.epson.co.uk>
- To email EPSON Technical Support:  
<http://www.epson.co.uk/support/email/>
- For a full list of EPSON Customer and Warranty Support services:  
<http://www.epson.co.uk/support/>

#### *Support Via Telephone*

Our Customer and Warranty Support teams can be contacted by calling 0870 163 7766 in the UK or 0044 0870 163 7766 from the Republic of Ireland. They can provide the following services:

- Technical information on installing, configuring and operating your EPSON products
- Arranging for faulty EPSON products to be repaired within the warranty period

## *Pre Sales Enquiry Desk*

Our Enquiry Desk team can be contacted by calling 0800 220546 in the UK or 1 800 409132 from the Republic of Ireland, by faxing 01442 227271 in the UK or 0044 1442 227271 from the Republic of Ireland, and via Email at [info@epson.co.uk](mailto:info@epson.co.uk). They can provide the following information:

- ❑ Pre sales information and literature on new EPSON products (also available via our world wide web site at <http://www.epson.co.uk>)
- ❑ Where to purchase genuine EPSON consumables, accessories, and options

## ***For Australia users***

EPSON Australia wishes to provide you with a high level of Customer Service. As well as the user's guide, we provide the following sources for obtaining information:

### *EPSON FAXBACK*

EPSON FAXBACK will fax you the latest specifications and pricing for most EPSON products offered in Australia. There is also technical information including details of the latest software and drivers available. Phone (02) 9903 9075 and the system will guide you through a number of choices before faxing the information to your fax machine.

### *EPSON Bulletin Board System*

This is where you can download the latest software and drivers. Visit the BBS to check out the latest versions. If you have a modem, phone (02) 9417 5090.

*Internet URL <http://www.epson.com.au>*

Access the EPSON Australia World Wide Web pages. Worth taking your modem here for the occasional surf! You can get the same information as offered on the EPSON FAXBACK and the EPSON Bulletin Board plus more.

### *Your dealer*

Don't forget that your dealer can often help identify and resolve problems. The dealer should always be the first call for advice on problems. They can often solve problems quickly and easily as well as give you advice on the next step to take.

### *EPSON Helpdesk*

EPSON Helpdesk is provided as a final backup to make sure our clients have access to advice. Operators on the Helpdesk can aid you in diagnosing hardware and software problems. They can also advise you on the latest EPSON products and where the nearest dealer or service agent is located. Many types of queries are answered here.

The Helpdesk numbers are:

Phone: (02) 9903 9040

Fax: (02) 9903 9189

We encourage you to have all the relevant information on hand when you ring. The more information you prepare, the faster we can help solve the problem. This information includes the *User's Guide* for your EPSON product, type of computer, operating system, application programs, and any other information you feel is required.

### ***For India users***

Contacts for information, support and services are:

*World Wide Web ([www.epson.co.in](http://www.epson.co.in))*

Information on product specifications, drivers for download, Frequently Asked Questions (FAQ) Product Enquiry and Technical Query are available.

*Epson India Bangalore Head Office:*

Phone: 080 5095465

Fax: 080 5095474

### ***For Malaysia users***

Contacts for information, support and services are:

*World Wide Web ([www.epson.com.my](http://www.epson.com.my))*

Information on product specifications, drivers for download, Frequently Asked Questions (FAQ) and Email Enquiry are available.

*Epson Trading Shah Alam Head Office*

Phone: 03 5191366

Fax: 03 5191281

### ***For Singapore users***

Sources of information, support and services available from Epson Singapore are:

*World Wide Web ([www.epson.com.sg](http://www.epson.com.sg))*

Information on product specifications, drivers for download, Frequently Asked Questions (FAQ), Sales Enquiry, and Technical Email Support are available.

*Epson HelpDesk <Phone: (065) 8323111>*

Our HelpDesk team can help you with the following over the phone:

Sales enquiry and product information

Product usage questions or problem

Enquiries on repair service and warranty

### ***For Hong Kong users***

To obtain technical support as well as other after-sales services, users are welcome to contact EPSON Hong Kong Limited.

### *Internet home page*

EPSON Hong Kong has established a local home page in both Chinese and English on the Internet to provide users with the following information:

- Product information
- Answers to Frequently Asked Questions (FAQs)
- Latest versions of EPSON printer drivers

Users can access our World Wide Web home page at:  
<http://www.epson.com.hk>

### *Electronic bulletin board system*

An electronic bulletin board system (BBS) is also available to obtain printer information and the latest versions of printer drivers. You can log on to the following number for the BBS service:

BBS:                   (852) 2827-4244



## *Technical Support Hotline*

You can also contact our technical staff at the following telephone and fax numbers:

Phone: (852) 2585-4399

Fax: (852) 2827-4383

## ***For Philippines users***

To obtain technical support as well as other after sales services, users are welcome to contact the EPSON Philippines Representative Office at the telephone and fax numbers below:

Phone: (632) 813-6552

Fax: (632) 813-6545

BBS: (632) 814-0595

# Options and Consumable Products

This chapter contains information on the EPSON options and consumable products that are available for your printer.

## Options

The following options are available for your printer.

### Interface cables

EPSON supplies the following interface cables. However, you can use any interface cable that meets these specifications. See your computer manual for any additional requirements.

- ❑ Parallel Interface Cable (shielded) C83602\* from D-SUB 25-pin (computer) to 36-pin Amphenol 57 Series (printer).
- ❑ USB Interface Cable (shielded) C83623\* from Series A 4-pin (computer) to Series B 4-pin (printer).

#### **Note:**

- ❑ *The asterisk (\*) is a substitute for the last digit of the product number, which varies by location.*
- ❑ *Depending on your geographic location, one or both of these cables may not be supplied.*



#### **Caution:**

*Use only interface cables which meet the specifications listed above. Using other cables not covered by EPSON warranties may cause the printer to malfunction.*

## Consumable products

The following ink cartridges and EPSON special media are available for your printer.

### Ink cartridges

You can use the following cartridges with your printer.

Black ink cartridge	T015
Color ink cartridge	T016

**Note:**

*The product numbers of ink cartridges may vary by location.*

### EPSON special media

EPSON offers specifically designed media for ink jet printers to meet most high-quality printing needs.

EPSON Glossy Paper - Photo Weight (Super A3)	S041347
EPSON Archival Matte Paper (Super A3/B)	S041339 S041340
EPSON Premium Semigloss Photo Paper (Super A3/B)	S041327 S041328
EPSON Premium Semigloss Photo Paper (4" × 26")	S041329
EPSON Premium Semigloss Photo Paper (100mm × 8M)	S041330

**Note:**

*The availability of special media varies by location.*

<b>EPSON OVERSEAS MARKETING LOCATIONS</b>
---

---

**EPSON AMERICA, INC.**

20770 Madrona Ave.  
P.O. Box 2842  
Torrance, CA 90509-2842  
Phone: (800) 922-8911  
Fax: (310) 782-5220

**EPSON UK LTD.**

Campus 100, Maylands Avenue,  
Hemel Hempstead, Herts,  
HP2 7TJ, U.K.  
Phone: (+44) 01442 261144  
Fax: (+44) 01442 227227

---

**EPSON DEUTSCHLAND GmbH**

Zülpicher Straße 6,  
40549 Düsseldorf Germany  
Phone: (0211) 56030  
Fax: (0211) 5047787

**EPSON FRANCE S.A.**

68 bis, rue Marjolin  
92300, Levallois-Perret, France  
Phone: 33.1.40.87.37.37  
Telex: 610657

---

**EPSON AUSTRALIA PTY. LTD.**

70 GIBBES STREET, CHATSWOOD 2067 NSW.  
Phone: 2-9903-9000  
Fax: 2-9903-9177

**EPSON SINGAPORE PTE. LTD.**

No. 1 Temasek Avenue #36-00  
Millenia Tower, Singapore 039192  
Phone: (065) 33 77 911  
Fax: (065) 33 41 185

---

**EPSON HONG KONG LTD.**

Rooms 4706-10, 47/F,  
China Resources Bldg.,  
26 Harbour Road, Wanchai, Hong Kong  
Phone: 2585-4300  
Fax: 2827-7083

**EPSON TAIWAN TECHNOLOGY & TRADING LTD.**

10F, No. 287 Nanking E. Road, Sec. 3,  
Taipei, Taiwan, R.O.C.  
Phone: (02) 717-7360  
Fax: (02) 712-9164

---

**EPSON ITALIA S.p.A.**

V.le F.lli Casiraghi 427  
20099 Sesto S.Giovanni  
MI, Italy  
Phone: 2-262331  
Fax: 2-2440750

**EPSON IBERICA S.A.**

Av. de Roma, 18-26  
08290 Cerdanyola del Valles  
Barcelona, Spain  
Phone: 582. 15.00  
Fax: 582. 15.55

---

**SEIKO EPSON CORPORATION  
(Hirooka Office)**

80 Harashinden, Hirooka  
Shiojiri-shi, Nagano-ken  
399-0785 Japan

**EPSON PORTUGAL, S.A.**

R. do Progresso, 471, 1° Perafita  
4460 Matosinhos, Portugal  
Phone: (02) 996 14 02  
Fax: (02) 996 14 11

**EPSON**

Color Ink Jet Printer



EPSON STYLUS™ **PHOTO 2000P**

*Daily Use*

Printed in Japan  
00.XX-XX