

EPSON

Color Ink Jet Printer

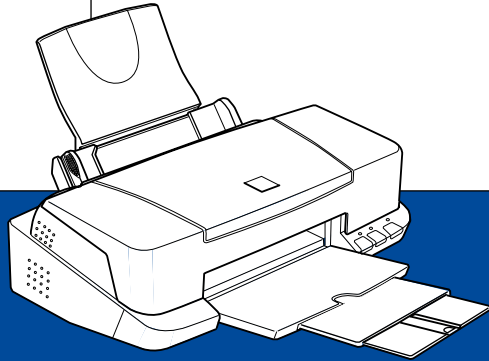

EPSON STYLUS™ COLOR 760
Daily Use

4010941
XXX-00

Where to Find Information

Setup Guide

- ❑ This guide will help you set up and begin using your printer. It includes information on setting up your printer and installing the printer software.

Daily Use Guide

- ❑ This guide provides information on daily printer operation. It also contains troubleshooting tips and customer support information.

Online Guides included on the CD-ROM

The guides on the CD-ROM included with your printer will help you learn more about your printer and color printing. To view these guides, you must have a Web browser installed on your computer. For more information on using this CD-ROM, see the included *CD-ROM Booklet*.

- ❑ ***Reference Guide*** Provides detailed information about printer software settings, printing on special paper, maintenance, and problem solving.
- ❑ ***Color Guide*** Includes sample images, explanations and troubleshooting information that will help answer your questions about color imaging and printing.

All rights reserved. No part of this publication may be reproduced, stored in a retrieval system, or transmitted in any form or by any means, electronic, mechanical, photocopying, recording, or otherwise, without the prior written permission of SEIKO EPSON CORPORATION. The information contained herein is designed only for use with this EPSON printer. EPSON is not responsible for any use of this information as applied to other printers.

Neither SEIKO EPSON CORPORATION nor its affiliates shall be liable to the purchaser of this product or third parties for damages, losses, costs, or expenses incurred by the purchaser or third parties as a result of: accident, misuse, or abuse of this product or unauthorized modifications, repairs, or alterations to this product, or (excluding the U.S.) failure to strictly comply with SEIKO EPSON CORPORATION's operating and maintenance instructions.

SEIKO EPSON CORPORATION shall not be liable for any damages or problems arising from the use of any options or any consumable products other than those designated as Original EPSON Products or EPSON Approved Products by SEIKO EPSON CORPORATION.

SEIKO EPSON CORPORATION shall not be held liable for any damage resulting from electromagnetic interference that occurs from the use of any interface cables other than those designated as EPSON Approved Products by SEIKO EPSON CORPORATION.

EPSON is a registered trademark and EPSON Stylus is a trademark of SEIKO EPSON CORPORATION.

Microsoft and Windows are registered trademarks of Microsoft Corporation.

General Notice: Other product names used herein are for identification purposes only and may be trademarks of their respective owners. EPSON disclaims any and all rights in those marks.

Copyright © 1999 by SEIKO EPSON CORPORATION, Nagano, Japan.



Printed on Recycled Paper.

Declaration of Conformity

According to ISO/IEC Guide 22 and EN 45014

Manufacturer: SEIKO EPSON CORPORATION

Address: 3-5, Owa 3-chome, Suwa-shi,
Nagano-ken 392-8502 Japan

Representative: EPSON EUROPE B.V.

Address: Prof. J. H. Bavincklaan 5 1183
AT Amstelveen
The Netherlands

Declares that the Product:

Product Name: Ink Jet Printer

Model: P150B

Conforms to the following Directive(s) and Norm(s):

Directive 89/336/EEC:

EN 55022 Class B

EN 61000-3-2

EN 61000-3-3

EN 50082-1

IEC 801-2

IEC 801-3

IEC 801-4

Directive 73/23/EEC:

EN 60950

August 1999

H. Horiuchi

President of EPSON EUROPE B.V.

Contents

Safety Instructions	1
Important Safety Instructions	1
A Few Precautions	2
When using the printer	2
When handling the ink cartridges	3
When choosing a place for the printer	3
ENERGY STAR Compliance	4
For United Kingdom Users	4
Warnings, Cautions, and Notes	5
Printer Parts and Functions	6
Printer Parts and Control Panel Functions	6
Loading Special Paper	8
Loading Special Paper and Other Media	8
About special media cleaning sheets	10
Loading Envelopes	10
Printing with Windows	12
Printer Software Introduction	12
Getting more information	12
Accessing the printer software	12
Making Changes to Printer Driver Settings	13
Making the Media Type setting	15
Using the Automatic mode	18
Using the Photo Enhance mode	19
Using the Custom mode	19
Previewing your printout	21
Making changes to printer driver settings for Windows 3.1	24
Getting Information Through Online Help	26
Accessing help from your application	26
Accessing help from Windows 95, 98 and NT 4.0	26
Accessing help from Windows 3.1	27

Printing with Macintosh	28
Printer Software Introduction	28
Making Changes to Printer Driver Settings	28
Making the Media Type setting	29
Using the Automatic settings	32
Using the Photo Enhance mode	32
Using the Custom mode	33
Previewing your printout	34
Saving print data in files	36
Replacing Ink Cartridges	37
Maintenance	43
Checking the Print Head Nozzles	43
Using the Nozzle Check utility	43
Using the control panel buttons	44
Cleaning the Print Head	45
Using the Head Cleaning utility	46
Using the control panel buttons	47
Aligning the Print Head	48
Troubleshooting	50
Can not install the USB Printer Driver	50
Make sure your computer is a Windows 98 pre-installed model	50
Make sure that EPSON USB Printer Devices appears in the Device Manager menu	50
Error Indicators	53
Typical Problems and Solutions	55
Print quality problems	55
Paper feed or paper jam problems	56
Printer does not work correctly with the USB	57
Cancelling Printing	57
For Windows 95, 98 and NT 4.0	58
For Windows 3.1	58
For Macintosh	59
Where to Get Help	60

Options and Consumable Products 65

Options 65

Consumable products 65

Safety Instructions

Important Safety Instructions

Read all of these instructions before using your printer. Also be sure to follow all warnings and instructions marked on the printer.

- Do not block or cover the openings in the printer's cabinet. Do not insert objects through the slots.
- Take care not to spill liquid on the printer.
- Use only the type of power source indicated on the printer's label.
- Connect all equipment to properly grounded power outlets. Avoid using outlets on the same circuit as photocopiers or air control systems that regularly switch on and off.
- Avoid electrical outlets controlled by wall switches or automatic timers.
- Keep the entire computer system away from potential sources of electromagnetic interference, such as loudspeakers or the base units of cordless telephones.
- Do not use a damaged or frayed power cord.
- If you use an extension cord with the printer, make sure the total ampere rating of the devices plugged into the extension cord does not exceed the cord's ampere rating. Also, make sure the total ampere rating of all devices plugged into the wall outlet does not exceed the wall outlet's ampere rating.
- Do not attempt to service the printer yourself.

- ❑ Unplug the printer and refer servicing to qualified service personnel under the following conditions:

The power cord or plug is damaged; liquid has entered the printer; the printer has been dropped or the cabinet damaged; the printer does not operate normally or exhibits a distinct change in performance.



- ❑ If you use the printer in Germany, observe the following:

To provide adequate short-circuit protection and over-current protection for this printer, the building installation must be protected by a 16 Amp circuit breaker.

Bei Anschluß des Druckers an die Stromversorgung muß sichergestellt werden, daß die Gebäudeinstallation mit einem 16 A-Überstromschalter abgesichert ist.

A Few Precautions

When using the printer

- ❑ Do not put your hand inside the printer or touch the ink cartridges during printing.
- ❑ Do not move the print head by hand; otherwise, you may damage the printer.
- ❑ Always turn the printer off using the  power button. When this button is pressed, the  power light flashes briefly then goes off. Do not unplug the printer or turn off the power to the outlet until the  power light stops flashing.
- ❑ Before transporting the printer, make sure the print head is in the home (far right) position and the ink cartridges are in place.

When handling the ink cartridges

- ❑ Keep ink cartridges out of the reach of children. Do not allow children to drink from or otherwise handle the cartridges.
- ❑ If ink gets on your skin, wash it off with soap and water. If it gets in your eyes, flush them immediately with water.
- ❑ Do not shake an ink cartridge; this can cause leakage.
- ❑ Install the ink cartridge immediately after you remove it from its package. Leaving the cartridge unpacked for a long time before use may result in reduced print quality.
- ❑ Once you install an ink cartridge, do not open the clamp or remove the cartridge except to replace it with a new one. The cartridge may become unusable otherwise.
- ❑ Do not use an ink cartridge beyond the date printed on the cartridge carton. For best results, use up the ink cartridges within six months of installing them.
- ❑ Do not dismantle the ink cartridges or try to refill them. This could damage the print head.

When choosing a place for the printer

- ❑ Place the printer on a flat, stable surface that is larger than the printer. The printer will not operate properly if it is tilted or at an angle.
- ❑ Avoid places subject to rapid changes in temperature and humidity. Also keep the printer away from direct sunlight, strong light, or heat sources.
- ❑ Avoid places subject to shocks and vibrations.
- ❑ Leave enough room around the printer to allow for sufficient ventilation.

- ❑ Place the printer near a wall outlet where the plug can be easily unplugged.

Note for French-speaking users:

Placez l'imprimante près d'une prise de contact où la fiche peut être débranchée facilement.

ENERGY STAR Compliance



As an ENERGY STAR Partner, EPSON has determined that this product meets the ENERGY STAR guidelines for energy efficiency.

The International ENERGY STAR Office Equipment Program is a voluntary partnership with the computer and office equipment industry to promote the introduction of energy-efficient personal computers, monitors, printers, fax machines, and copiers in an effort to reduce air pollution caused by power generation.

For United Kingdom Users

Use of options

EPSON (UK) Limited shall not be liable against any damages or problems arising from the use of any options or consumable products other than those designated as Original EPSON Products or EPSON Approved Products by EPSON (UK) Limited.

Safety information



Warning:

This appliance must be earthed. Refer to the rating plate for voltage and check that the appliance voltage corresponds to the supply voltage.

Important:

The wires in the mains lead fitted to this appliance are coloured in accordance with the following code:

Green and yellow — Earth

Blue — Neutral

Brown — Live

If you have to fit a plug:

As the colours of the mains lead of this appliance may not match coloured markings used to identify the terminals in a plug, please proceed as follows:

The green and yellow wire must be connected to the terminal in the plug which is marked with the letter E or the earth symbol (\perp).

The blue wire must be connected to the terminal in the plug marked with the letter N.

The brown wire must be connected to the terminal in the plug marked with the letter L.

If damage occurs to the plug, replace the cord set or consult a qualified electrician.

Replace fuses only with a fuse of the correct size and rating.

Warnings, Cautions, and Notes



Warnings

must be followed carefully to avoid bodily injury.



Cautions

must be observed to avoid damage to your equipment.

Notes





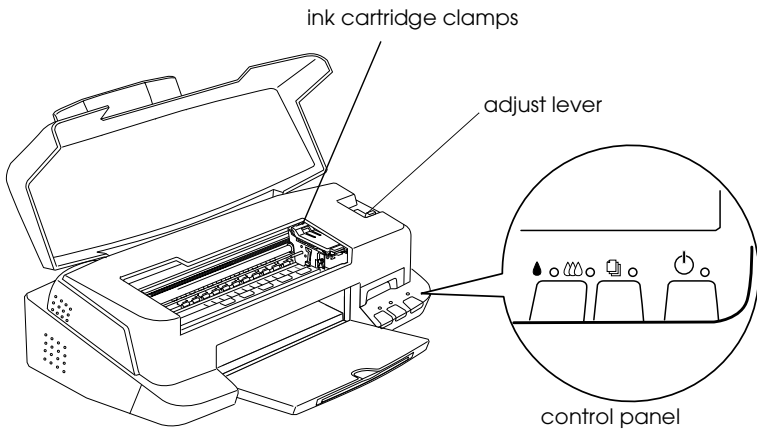
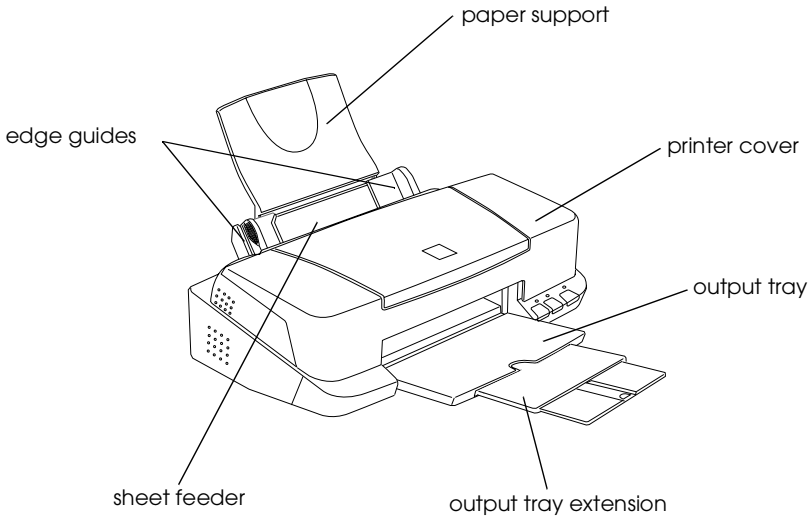

contain important information and useful tips on the operation of your printer.

Printer Parts and Functions





Printer Parts and Control Panel Functions



Buttons

Button	Function
 Power	<p>Turns the printer on and off.</p> <p>Clears the printer's memory if pressed twice while the power is on.</p>
 Load/Eject	<p>Loads or ejects paper if pressed and released within 2 seconds.</p> <p>Resumes printing if pressed and released after a paper out error.</p>
 Cleaning	<p>Moves the print head to the ink cartridge replacement position if pressed for 3 seconds while the  black or  color ink out light is flashing or on.</p> <p>Returns the print head to its home position after ink cartridge replacement.</p> <p>Performs print head cleaning if pressed for 3 seconds when the  black or  color ink out light is off.</p>

Lights

Light	Printer Status
 Power	<p>On when the printer is on.</p> <p>Flashes when receiving data, printing, replacing an ink cartridge, charging ink, or cleaning the print head.</p>
 Paper out	<p>On when the printer is out of paper. Load paper in the sheet feeder, then press the  load/eject button to resume printing.</p> <p>Flashes when the paper is jammed. Take all of the paper out of the feeder, then reload the paper. If the light continues to flash, turn off the printer and gently pull all the paper out of the printer.</p>
 Black ink out	<p>Flashes when the black ink cartridge is nearly empty.</p> <p>On when the black ink cartridge is empty. Replace the black ink cartridge (S020189).</p>
 Color ink out	<p>Flashes when the color ink cartridge is nearly empty.</p> <p>On when the color ink cartridge is empty. Replace the color ink cartridge (S020191).</p>

Loading Special Paper

Loading Special Paper and Other Media

You can print on a wide variety of special media, including ink jet paper, photo quality glossy film, photo paper, transparencies, envelopes, index cards, and adhesive sheets.

When loading special paper distributed by EPSON, read the instruction sheets packed with your special media first and keep the following points in mind. For more details on using such media, see “Paper Handling” on page 19.

- ❑ Make sure the printable side of the paper is facing up when loading media into the sheet feeder. See the instruction sheets packed with the media to determine which side is the printable surface. Some media have cut corners to help identify the correct loading direction, as shown in the illustration.

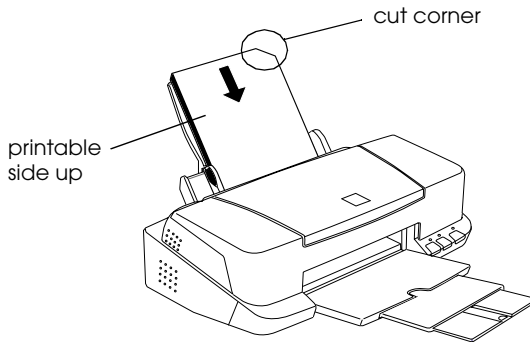

- ❑ Make sure the paper stack fits under the arrow mark located on the inside surface of the left edge guide.

❑ Loading capacity for envelopes and EPSON special media is explained below.

Envelopes	Up to 10 envelopes.
	Note: If the total thickness of the stack of envelopes exceeds 10 mm, press each envelope flat before loading.
360 dpi Ink Jet Paper and Photo Quality Ink Jet Paper	Up to the arrow mark on the left edge guide.
Photo Quality Ink Jet Card, Ink Jet Note Card, and Ink Jet Greeting Card	Up to 30 index cards. Always place the included support sheet* under the cards.
Photo Quality Glossy Film	One sheet at a time for best results. Always put a support sheet* or a sheet of plain paper under the glossy film. If you wish to load multiple sheets, load a maximum of 20 sheets and set the minimum top margin of the page to 30 mm.
Ink Jet Transparencies	Up to 30 transparencies. Always put a sheet of plain paper under the stack of transparencies.
Photo Quality Self Adhesive Sheet	One sheet at a time.
Photo Paper	Up to 20 sheets of 4 × 6 inch Photo Paper. Always put a support sheet* under the stack of Photo Paper. 200 × 300 mm Photo Paper can only be loaded 1 sheet at a time.
Photo Stickers 16 and Photo Stickers 4	One sheet at a time. Always put the included Support Sheets A and B under the stack of Photo Stickers.
Panoramic Photo Paper and Iron-On Cool Peel Transfer Paper	One sheet at a time.

Matte Paper-Heavyweight Up to 20 sheets. Always put a support sheet* under the stack of Matte Paper-Heavyweight.

* Take care not to print on support sheets loaded under special media.

About special media cleaning sheets

Cleaning sheets packaged with EPSON special media should not be used with this printer. The cleaning function performed by these sheets is not necessary with this type of printer, and the sheets could jam in the printer.

Loading Envelopes

When printing on envelopes, please note the following:

- You can load up to 10 envelopes into the sheet feeder.

Note:

The folding quality and thickness of envelopes varies widely. If the total thickness of the stack of envelopes exceeds 10 mm, press each envelope in the stack flat before loading.

- Set the adjust lever to the “+” position. To do this, open the printer cover and reposition the lever.

Note:

- Return the adjust lever to the “0” position, which is the normal position, after you finish printing on envelopes. Leaving the lever in the “+” position may cause gaps to appear in images printed on other media.*

- When the adjust lever is in the “+” position, make sure the High Speed setting in the printer driver’s Advanced dialog box is off. To turn this option off, you may also need to change the Print Quality setting.*

- ❑ Load envelopes flap edge first with the flap side down, as shown in the illustration.

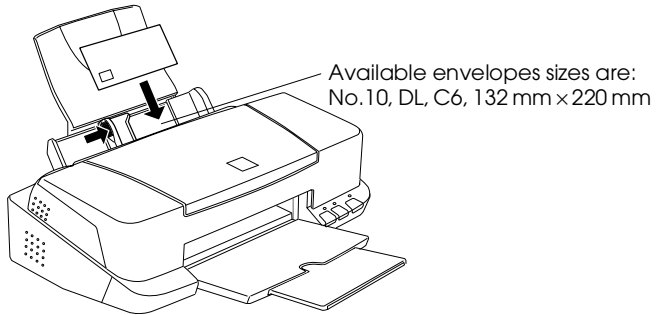

- ❑ Do not use envelopes that are curled or folded. Make sure to flatten the envelope flaps before loading. Also avoid using envelopes that are too thin; they may curl during printing.
- ❑ Select Plain Paper as the Media Type setting on the printer driver.

Printing with Windows

Printer Software Introduction

The printer software includes a printer driver and printer utilities. The printer driver lets you choose from a wide variety of settings to get the best results from your printer. The printer utilities help you check the printer and keep it in top condition.

Getting more information

For information on using the printer driver, see “Making Changes to Printer Driver Settings” on page 13.

For information on using the printer utilities, see “Using the Printer Utilities” in the online *Reference Guide*.

Note:

The specific features available in the printer software vary depending on the version of Windows you are using.

Online help provides more information about the printer software. See “Getting Information Through Online Help” on page 26 for instructions on accessing help.

Accessing the printer software

You can access the printer software from most Windows applications, or from the Windows Start menu (Windows 95, 98 and NT 4.0), or from the Control Panel (Windows 3.1).

When you access the printer software from a Windows application, the settings you make apply only to the application you are using.

When you access the printer software from the Start menu, the settings you make apply to all of your Windows applications.

From Windows applications

Open the File menu and choose Print or Print Setup. Then click Printer, Setup, Options, or Properties. (Depending on your application, you may need to click a combination of these buttons.) The printer software window appears.

From Windows 95, 98, or NT 4.0

1. Click Start, point to Settings, then click Printers.
2. For Windows 95 and 98, select your printer, then click Properties on the File menu. For Windows NT 4.0, select your printer, then click Document Defaults on the File menu. The printer software window appears.

From Windows 3.1

1. Double-click the Control Panel icon in the Main group.
2. Double-click the Printers icon.
3. Choose your printer from the Installed Printers list.
4. Choose Setup. The printer software window appears.

Making Changes to Printer Driver Settings

The printer software features the following printer driver setting menus.

Main Media Type, Ink, Mode

Paper Paper size, Copies, Orientation, Printable Area

Note:

The Layout menu is available only for Windows 95, 98 and NT 4.0 users.

The Mode options on the Main menu are arranged to give you four levels of control over the printer driver, as explained below.

Automatic	The quickest and easiest way to start printing. See "Using the Automatic mode" on page 18 for Windows 95, 98 and NT 4.0 or "Using the Automatic setting" on page 24 for Windows 3.1.
PhotoEnhance	Lets you apply a variety of image-correction settings specially designed for photos. See "Using the Photo Enhance mode" on page 19.
Custom	Choose from a list of ready-made settings suited to the kind of document you want to print. You can also add your own settings to this list. See "Using the Custom mode" on page 19 for Windows 95, 98 and NT 4.0 or "Using the Custom settings" on page 25 for Windows 3.1.
Advanced	Allows you to make detailed settings to fit your individual needs. You can also add your settings to the Custom Settings list.

Note:

PhotoEnhance setting is available only for Windows 95, 98 and NT 4.0 users.

In addition to making groups of settings that affect overall print quality, you can also modify individual aspects of the print style and layout using the Paper and Layout menus. For more information about the Paper and Layout menus, see your online *Reference Guide*.

Making the Media Type setting

The Media Type setting determines what other settings are available, so you should always make this setting first.

On the Main menu, select the Media Type setting that matches the paper you loaded in the printer. Find your paper in the list below, then select a corresponding Media Type setting (shown in larger type). For some kinds of paper, you have several Media Type settings to choose from.

Note:

For Windows 3.1, if the Media Type you want to select does not appear in the list, change the Print Quality setting in the More Settings dialog box first. To access this box, click Advanced on the Main menu, then click More Settings.

Plain Paper

Plain paper

Envelopes

EPSON Premium Ink Jet Plain Paper (A4)	S041214
--	---------

360 dpi Ink Jet Paper

EPSON 360 dpi Ink Jet Paper (A4)	S041059
	S041025

EPSON 360 dpi Ink Jet Paper (Letter)	S041060
	S041028

EPSON Iron-On Cool Peel Transfer Paper (A4)	S041154
---	---------

EPSON Iron-On Cool Peel Transfer Paper (Letter)	S041153
	S041155

Photo Quality Ink Jet Paper

EPSON Photo Quality Ink Jet Paper (A4)	S041061
	S041026

EPSON Photo Quality Ink Jet Paper (Letter)	S041062
	S041029

EPSON Photo Quality Ink Jet Paper (Legal)	S041067
	S041048

EPSON Photo Quality Ink Jet Card (A6)	S041054
---------------------------------------	---------

EPSON Photo Quality Ink Jet Card (5 × 8")	S041121
---	---------

EPSON Photo Quality Ink Jet Card (8 × 10")	S041122
--	---------

EPSON Photo Quality Self Adhesive Sheet (A4)	S041106
--	---------

EPSON Ink Jet Note Cards A6 (with envelopes)	S041147
--	---------

EPSON Ink Jet Greeting Cards 5 x 8" (with envelopes)	S041148
--	---------

EPSON Ink Jet Greeting Cards 8 x 10" (with envelopes)	S041149
---	---------

Photo Paper

EPSON Photo Paper (A4)	S041140
EPSON Photo Paper (Letter)	S041141
EPSON Photo Paper (4 × 6")	S041134
EPSON Photo Paper (100 × 150 mm)	S041255
EPSON Photo Paper (200 × 300 mm)	S041254
EPSON Panoramic Photo Paper (210 × 594 mm)	S041145
EPSON Photo Paper Cards (A4)	S041177

Photo Quality Glossy Film

EPSON Photo Quality Glossy Film (A4)	S041071
EPSON Photo Quality Glossy Film (Letter)	S041072
EPSON Photo Quality Glossy Film (A6)	S041107
EPSON Photo Stickers 16 (A6)	S041144
EPSON Photo Stickers 4 (A6)	S041176

Ink Jet Transparencies

EPSON Ink Jet Transparencies (A4)	S041063
EPSON Ink Jet Transparencies (Letter)	S041064

Matte Paper-Heavyweight

EPSON Matte Paper-Heavyweight (A4)	S041256 S041258 S041259
EPSON Matte Paper-Heavyweight (Letter)	S041257

Note:

The availability of special media varies by location.

Using the Automatic mode

Note:

If you are using Windows 3.1, see “Making changes to printer driver settings for Windows 3.1” on page 24.

When Automatic is selected on the Main menu, the printer driver takes care of all detailed settings based on the current Media Type and Ink settings. To make the Ink setting, click **Color** to print in color, or **Black** to print in black-and-white or grayscale. To make the Media Type setting, see “Making the Media Type setting” on page 15.



Note:

- ❑ Depending on the media you choose in the Media Type list (while Automatic is selected), a slide bar appears in the Mode box that lets you choose Quality, Speed or an intermediate setting. Select Quality when print quality is more important than speed.
- ❑ Most Windows applications feature paper size and page layout settings that override similar settings on the printer driver. However, if your application does not have these settings, verify the settings on the printer driver's Paper menu.

Using the Photo Enhance mode

The Photo Enhance option provides a variety of image-correction settings that you can apply to your photo images before printing. Photo Enhance does not affect your original data.

If you are printing photos taken with a digital camera, you can also select the Digital Camera Correction check box to give your printed images the smooth, natural appearance of photographs taken with a film camera.

Note:

- This mode is available only when you are printing 24 or 32 bit Color Image.*
- Printing with Photo Enhance selected may increase print time depending on your computer system and the amount of data contained in your image.*

The Photo Enhance mode provides the following settings.

Standard	Standard image correction for most photos. Try this setting first.
People	Best for photos of people.
Nature	Best for outdoor scenery such as mountains, sky, and oceans.
Soft Focus	Makes your photos look as if they were taken with a soft-focus lens.
Sepia	Applies a sepia tone to your photos.

Using the Custom mode

Note:

If you are using Windows 3.1, see "Making changes to printer driver settings for Windows 3.1" on page 24.

The Custom mode offers ready-made settings designed for printing text and graphs and for applying a color-matching method. You can also create and save your own Custom settings.

The Custom mode provides the following ready-made settings.

Text/Graph	Good for printing presentation documents such as graphs and charts.
Economy	Good for printing drafts of text
ICM (For Windows 95 and 98)	ICM means Image Color Matching. This feature automatically adjusts printout colors to match colors on your screen.
sRGB	Best for color matching with other sRGB devices.

Follow the steps below to select a Custom setting.

1. Click the Custom button on the Main menu.
2. Click anywhere in the list box to open it, then select the most appropriate setting for the type of document or image you will print.
3. When you choose a Custom setting, other settings such as Print Quality, Halftoning, and Color Adjustment are set automatically. Changes are shown in the display on the left side of the Main menu.
4. Before printing, be sure to verify the Media Type and Ink settings, as they may be affected by the Custom setting you select. See “Making the Media Type setting” on page 15.



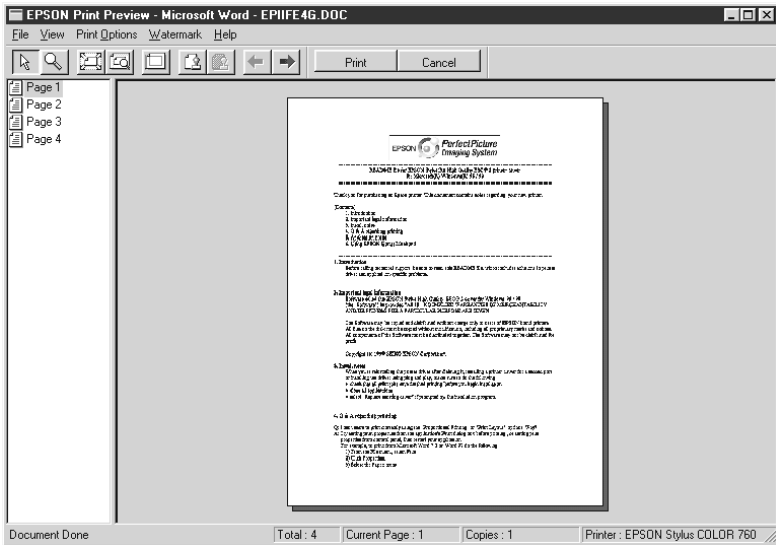

Previewing your printout

To see a preview of your document before printing it, select the Print Preview check box on the Main menu. When you print your document, the Print Preview window appears:



The Preview dialog box contains several icon buttons you can use to perform the following functions.



	Zoom	This option enlarges the size of the previewed page by a factor of 2.
	Fit-to-screen	This option scales the previewed page so that it just fits the size of the page display window. Select this option if you want to see the entire page at one time.
	Maximum zoom	This option displays the previewed page at the maximum possible zoom ratio.

	Printable area on/off	Selecting this option will display a rectangle on the page being previewed. This rectangle is the printable area for the page. The printer cannot print anything which exceeds this rectangle.
	Watermark	This option displays the watermark settings dialog. This dialog allows you to change any of the current watermark settings.
	Reset watermark settings	This option returns all watermark settings to what they were when the Preview was first opened. If nothing has been changed, this option appears grayed out.
	Previous page	This option displays the page previous to the page currently being previewed. (If there is no previous page then this option is grayed out)
	Next page	This option displays the next page in the document. (If there is no next page then this option is grayed out)

You can also manipulate the previewed document in the following ways:

- Select and preview individual pages.
- Reduce or enlarge the size of the preview.
- Select and print any or all pages.
- Apply watermarks. The watermark you select will appear in the previewed image. For detailed information on customizing watermarks, see “Printing a watermark on your document” in your *Reference Guide*.

- ❑ The Add and Remove options allow you to specify which pages in the document you wish to be printed. To add or remove page, you must first highlight the page in the list of page icons appearing on the left side of the preview window. Highlight the page by clicking once on the page icon. Then select or deselect from the Print Options menu.

	Add page	The highlighted pages will be added to the list of pages to be printed.
	Remove page	The highlighted pages will be removed from the list of pages to be printed.

After you have previewed the document, click **Print** to print the document, or click **CANCEL** to cancel printing.

Making changes to printer driver settings for Windows 3.1

Using the Automatic setting

When Automatic is selected on the Main menu, the printer driver takes care of all detailed settings based on the current Media Type and Ink settings. To make the Ink setting, click **Color** to print in color, or **Black** to print in black-and-white or grayscale. To make the Media Type setting, see “Making the Media Type setting” on page 15.



Note:

- ❑ Depending on the media you choose in the Media Type list (while Automatic is selected), a slide bar appears in the Mode box that lets you choose Quality, Speed, or an intermediate setting. Select Quality when print quality is more important than speed.
- ❑ Most Windows applications feature paper size and page layout settings that override similar settings on the printer driver. However, if your application does not have these settings, verify the settings on the printer driver's Paper menu.

Using the Custom settings

The Custom settings let you make a wide range of changes with a single click of the mouse. In the Custom settings list, you'll find ready-made settings provided by EPSON designed to match a particular kind of printout, such as graphs and charts used in a presentation, or images taken by a digital camera.

You can also create your own settings and add them to this list. See "Using the Advanced settings" on page 45 for details.

The Custom settings list includes the following ready-made settings.

Text/Graph	Good for printing presentation documents such as graphs and charts.
PhotoEnhance	Best for printing images captured using a video or scanner or digital camera. This setting automatically adjusts the contrast, saturation, and brightness of the original image data to produce sharper, more vivid color printouts. PhotoEnhance does not affect your original image data. Note: Printing with PhotoEnhance selected may increase print time depending on your computer system and the amount of data contained in your image.
Economy	Good for printing drafts of text

Follow the steps below to select a Custom setting.

Note:

The Custom button in these instructions appears as the Advanced button in the actual Windows 3.1 printer driver. Please substitute "Custom" with "Advanced" when following these steps.

1. Click the Advanced button on the Main menu.
2. From the Custom settings list, select the most appropriate setting for the type of document or image you will print.

3. When you choose a Custom setting, other settings such as Print Quality, Halftoning, and Color Adjustment are set automatically. Changes are shown in the Current Settings display at the bottom of the Main menu.
4. Before printing, be sure to verify the Media Type and Ink settings, as they may be affected by the Custom setting you select. See “Making the Media Type setting” on page 15.

Getting Information Through Online Help

Your printer software has an extensive online help feature, which provides you with instructions on printing, making printer driver settings, and using printer utilities.

Accessing help from your application

Open the File menu and choose Print or Print Setup. Then click Printer, Setup, Options, or Properties. (Depending on your application, you may need to click a combination of these buttons.) Click Help at the bottom of the Main, Paper, Layout, and Utility menus for help related to the items on that menu.

For Windows 95, 98 and NT 4.0, you can get specific help related to any item on a menu by right-clicking the item, then clicking the What's This? prompt.

Accessing help from Windows 95, 98 and NT 4.0

Click the Start button, point to Programs and Epson (for Windows 95 and 98) or EPSON Printers (for Windows NT 4.0), then click EPSON Stylus COLOR 760 Help. The help contents window appears.

Accessing help from Windows 3.1

Open the EPSON group and click the EPSON Stylus COLOR 760 Help icon. The help contents window appears.

Printing with Macintosh

Printer Software Introduction

The printer software includes a printer driver and printer utilities. The printer driver lets you choose from a wide variety of settings to get the best results from your printer. The printer utilities help you check the printer and keep it in top condition.



For information on using the printer driver, see “Making Changes to Printer Driver Settings” on page 28.

For information on using the printer utilities, see “Using the Printer Utilities for Macintosh” in the online *Reference Guide*.

You can get more information about the printer software by clicking the help icon in the printer software dialog boxes.

Making Changes to Printer Driver Settings

You will find the printer driver settings in the following dialog boxes.

- Print dialog box (click Print on the File menu of your application or click Options in the Page Setup dialog box)
- Page Setup dialog box (click Page Setup on the File menu of your application)
- Layout dialog box (click the  Layout icon button in the Print dialog box)
- Background Printing dialog box (click the  Background Printing icon button located in the Print dialog box)

- ❑ Preview dialog box (click the  Preview icon button and then click Preview in the Print dialog box)

The Mode options in the Print dialog box are arranged to give you four levels of control over the printer driver, as explained below.

Automatic	The quickest and easiest way to start printing. See "Using the Automatic settings" on page 32.
Custom	Choose from a list of ready-made settings suited to the kind of document you want to print. You can also add your own settings to this list. See "Using the Custom mode" on page 33.
Advanced	Allows you to make detailed settings to fit your individual needs. You can also add your settings to the Custom Settings list.
PhotoEnhance	Lets you apply a variety of image-correction settings specially designed for photos. See "Using the Photo Enhance mode" on page 32.

In addition to making groups of settings that affect overall print quality, you can also change page setup and layout using the Page Setup and the Layout dialog boxes. For information on page setup options. For information on page layout options.

Making the Media Type setting

The Media Type setting determines what other settings are available, so you should always make this setting first.

In the Print dialog box, select the Media Type setting that matches the paper you loaded in the printer. Find your paper in the list below, then select a corresponding Media Type setting (shown in larger type). For some kinds of paper, you have several Media Type settings to choose from.

Plain Paper

Plain paper

Envelopes

EPSON Premium Ink Jet Plain Paper (A4) S041214

360 dpi Ink Jet Paper

EPSON 360 dpi Ink Jet Paper (A4) S041059
S041025

EPSON 360 dpi Ink Jet Paper (Letter) S041060
S041028

EPSON Iron-On Cool Peel Transfer Paper (A4) S041154

EPSON Iron-On Cool Peel Transfer Paper (Letter) S041153
S041155

Photo Quality Ink Jet Paper

EPSON Photo Quality Ink Jet Paper (A4) S041061
S041026

EPSON Photo Quality Ink Jet Paper (Letter) S041062
S041029

EPSON Photo Quality Ink Jet Paper (Legal) S041067
S041048

EPSON Photo Quality Ink Jet Card (A6) S041054

EPSON Photo Quality Ink Jet Card (5 × 8") S041121

EPSON Photo Quality Ink Jet Card (8 × 10") S041122

EPSON Photo Quality Self Adhesive Sheet (A4) S041106

EPSON Ink Jet Note Cards A6 (with envelopes) S041147

EPSON Ink Jet Greeting Cards 5 x 8" (with envelopes) S041148

EPSON Ink Jet Greeting Cards 8 x 10" (with envelopes) S041149

Photo Paper

EPSON Photo Paper (A4)	S041140
EPSON Photo Paper (Letter)	S041141
EPSON Photo Paper (4 × 6")	S041134
EPSON Photo Paper (100 × 150 mm)	S041255
EPSON Photo Paper (200 × 300 mm)	S041254
EPSON Panoramic Photo Paper (210 × 594 mm)	S041145
EPSON Photo Paper Cards (A4)	S041177

Photo Quality Glossy Film

EPSON Photo Quality Glossy Film (A4)	S041071
EPSON Photo Quality Glossy Film (Letter)	S041072
EPSON Photo Quality Glossy Film (A6)	S041107
EPSON Photo Stickers 16 (A6)	S041144
EPSON Photo Stickers 4 (A6)	S041176

Ink Jet Transparencies

EPSON Ink Jet Transparencies (A4)	S041063
EPSON Ink Jet Transparencies (Letter)	S041064

Matte Paper-Heavyweight

EPSON Matte Paper-Heavyweight (A4)	S041256 S041258 S041259
EPSON Matte Paper-Heavyweight (Letter)	S041257

Note:

The availability of special media varies by location.

Using the Automatic settings

When Automatic is selected as the Mode option in the Print dialog box, the printer driver takes care of all detailed settings based on the current Media Type and Ink settings. To make the Ink setting, click **Color** to print in color, or **Black** to print in black-and-white or grayscale. To make the Media Type setting, see “Making the Media Type setting” on page 29.

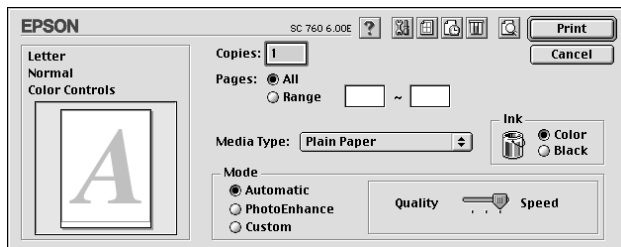

Note:

Depending on the media you choose in the Media Type list while Automatic is selected, a slide bar appears in the Mode box that lets you choose Quality, Speed or an intermediate setting. Select Quality when print quality is more important than speed.

Using the Photo Enhance mode

The Photo Enhance option provides a variety of image-correction settings that you can apply to your photo images before printing. Photo Enhance does not affect your original data.

If you are printing photos taken with a digital camera, you can also select the Digital Camera Correction check box to give your printed images the smooth, natural appearance of photographs taken with a film camera.

Note:

- ❑ *This mode is available only when you are printing 24 or 32 bit Color Image.*

- ❑ *Printing with Photo Enhance selected may increase print time depending on your computer system and the amount of data contained in your image.*

The Photo Enhance mode provides the following settings.

Standard	Standard image correction for most photos. Try this setting first.
People	Best for photos of people.
Nature	Best for outdoor scenery such as mountains, sky, and oceans.
Soft Focus	Makes your photos look as if they were taken with a soft-focus lens.
Sepia	Applies a sepia tone to your photos.

Using the Custom mode

The Custom mode offers ready-made settings designed for printing text and graphs and for applying a color-matching method. You can also create and save your own Custom settings.

The Custom mode provides the following ready-made settings.

Text/Graph	Good for printing presentation documents such as graphs and charts.
Economy	Good for printing drafts of text.
ColorSync	This feature automatically adjusts printout colors to match colors on your screen.

Follow these steps to select a Custom setting.

1. Verify the Media Type and Ink settings in the Print dialog box. For details, see “Making the Media Type setting” on page 29.





2. Click the Custom button in the Print dialog box. This activates the Custom Settings list, located below and to the right of the Custom radio button.
3. From the Custom Settings list, select the most appropriate setting for the type of document or image you will print.
4. When you choose a Custom setting, other settings such as Print Quality, Halftoning, and Color are set automatically. Changes are shown in the display on the left side of the Print dialog box.

Previewing your printout

Clicking the  Preview icon button in the Print dialog box allows you to see how your document will look before actually printing it. Follow these steps to use this feature.

1. Make your printer driver settings.
2. Click the  Preview icon button in the Print dialog box. The Print button changes into a Preview button.

Note:

Use the  Preview icon button to switch between the  Print,  Preview, and  Save File modes. Click the icon to select the mode you want. For information on the Save File mode, see “Saving print data in files” on page 36.

- Click the Preview button. The Preview dialog box appears and displays a preview of your document.

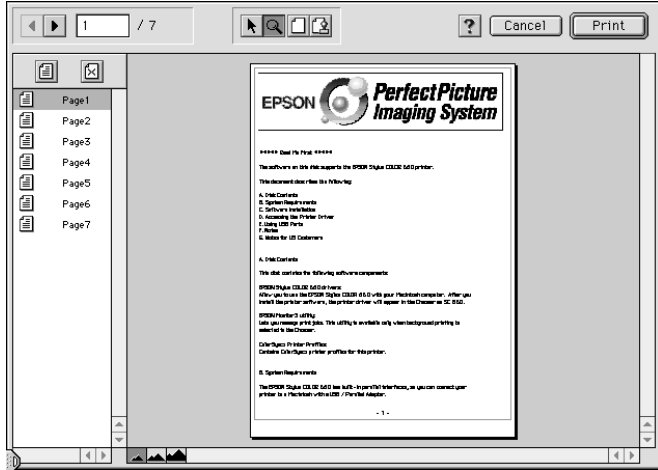

The Preview dialog box contains six icon buttons you can use to perform the following functions.

	Selection	Lets you select, move, and resize watermarks.
	Zoom	Enlarges or reduces the viewing size of the previewed page.
	Margin Display/ Non-Display	Shows or hides borderlines indicating the printable area.
	Watermark Editing	Shows or hides the Watermark Edit box. Use this box to apply watermarks to the document.
	Add Page Remove Page	Lets you select or deselect the pages you want to print from the left-side column.





4. If you are satisfied with the previewed image, click Print.

If you are not satisfied with the appearance of the image, click Cancel. The Preview and Print dialog boxes close with the current print settings preserved. Open the Print dialog box again to make more changes to the print settings.

Saving print data in files

You can save print data in a file by using the  Save File icon button in the Print dialog box. This feature lets you print the data at a later time simply by double-clicking the saved file. Follow these steps.

Note:

Use the  Preview icon button to switch between the  Print,  Preview, and  Save File modes. Click the icon to select the mode you want.



1. Make your printer driver settings.
2. Click the  Preview icon button in the Print dialog box repeatedly until the Print button changes into the Save File button.
3. Click the Save File button.
4. Select the location where you want to save the file, then type a file name into the Save As box and click Save.

When you want to print the data, double-click the file to open EPSON Monitor 3. Click the  Resume button to send the data to the printer.









Replacing Ink Cartridges

The printer's indicator lights will inform you when it is time to obtain a replacement ink cartridge and when it is time to replace an empty cartridge. You can also check ink levels and start the ink cartridge replacement procedure from your computer using the Status Monitor utility. See the online *Reference Guide* for more information.

Note:

If you need to replace an ink cartridge when the  black and  color lights are off, see "Replacing an Old or Damaged Ink Cartridge" in the online *Reference Guide*.

This table describes the status of the lights on your printer and the actions you need to take.

Lights	Action
 	Obtain a replacement black ink cartridge (S020189).
 	Replace the empty black ink cartridge.
 	Obtain a replacement color ink cartridge (S020191).
 	Replace the empty color ink cartridge.

● = on, ◌ = flashing



Warning:

- Keep ink cartridges out of the reach of children. Do not allow children to drink from or otherwise handle the cartridges.
- If ink gets on your hands, wash them thoroughly with soap and water. If ink gets into your eyes, flush them immediately with water. If discomfort or vision problems remain after a thorough flushing, see a doctor immediately.



Caution:

- ❑ *EPSON recommends the use of genuine EPSON ink cartridges. Other products not manufactured by EPSON may cause damage to your printer not covered by EPSON's warranties.*

- ❑ *Leave the old cartridge installed in the printer until you have obtained a replacement. Otherwise, ink remaining in the print head nozzles may dry out.*

Note:



- ❑ *You cannot continue printing with one ink cartridge empty, even if the other cartridge still contains ink. Before printing, replace the empty cartridge.*

- ❑ *In addition to the ink used during document printing, ink is consumed during the print head cleaning operation and during the self-cleaning cycle which is performed when the printer is turned on.*



To replace an ink cartridge using the printer's control panel, follow the steps below.

Note:

You can also replace an ink cartridge from your computer using the Status Monitor. Click the Replace Ink Cartridge button in the Status Monitor's Printer Status window, then follow the on-screen instructions.



1. Make sure the printer is on. The  power light should be on, but not flashing. (Determine which cartridge needs to be replaced as indicated by the  black and  color ink out light.)

2. Lower the output tray at the front of the printer, then open the printer cover.

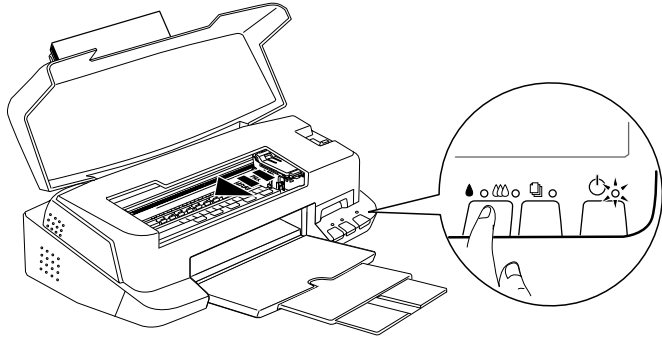



3. Hold down the   cleaning button for three seconds. The print head moves left to the ink cartridge replacement position, and the  power light begins flashing.



Caution:

Do not move the print head by hand as this may damage the printer. Always use the   cleaning button to move it.

Note:

If you press the   cleaning button for three seconds when the  black and  color ink out lights are off, the printer starts cleaning the print head.

4. Lift up the clamp that holds the cartridge you want to replace as far as it will go. The cartridge rises partly out of the cartridge holder.

The illustration shows color ink cartridge replacement. To replace the black ink cartridge, lift up only the smaller clamp on the left.

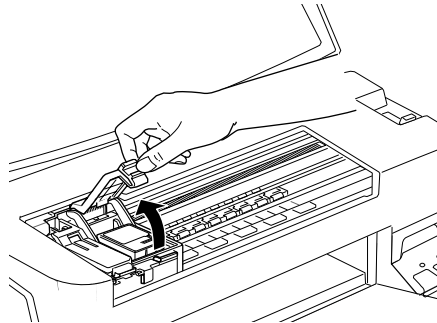



Caution:

Once you open the ink cartridge clamp, the ink cartridge becomes unusable and cannot be reinstalled, even if ink remains.

5. Lift the cartridge out of the printer and dispose of it properly. Do not take the used cartridge apart or try to refill it.

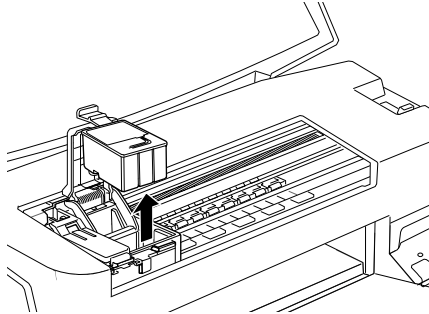

Warning:

If ink gets on your hands, wash them thoroughly with soap and water. If ink gets into your eyes, flush them immediately with water.

6. Remove the new ink cartridge from its protective bag. Next, remove only the yellow tape seal from the cartridge.

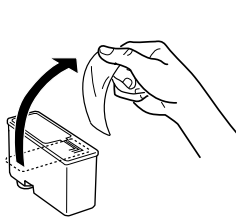

black ink cartridge (S020189)

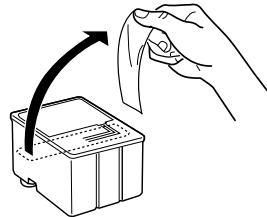

color ink cartridge (S020191)



Caution:

- ❑ *You must remove the yellow tape seal from the cartridge before installing it, otherwise, a fatal error will occur and the cartridge will become unusable.*
 - ❑ *Do not remove the blue portion of the tape seal from the top of the cartridge; otherwise, the print head may become clogged and will be unable to print.*
 - ❑ *Do not remove the tape seal from the bottom of the cartridge; otherwise, ink will leak.*
7. Place the ink cartridge gently into the cartridge holder with the label on the cartridge facing up. Do not press down on the cartridge.

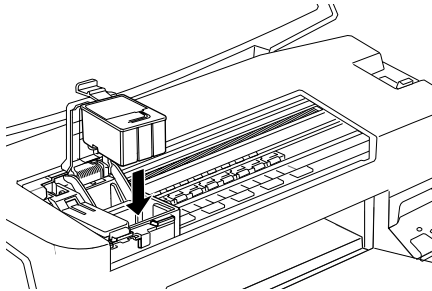

8. Press the ink cartridge clamp down until it locks in place.



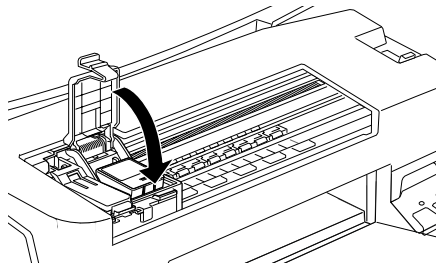

The illustration shows color ink cartridge replacement. To replace the black ink cartridge, lift up only the smaller clamp on the left.







Caution:

Once you install the ink cartridges, do not open their clamps again until you replace the cartridges. Otherwise, the cartridges may become unusable.

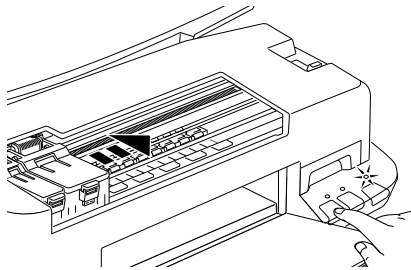
9. Make sure the  black and  color lights are off, then press the  cleaning button. The printer moves the print head and begins charging the ink delivery system. This process takes about thirty seconds to complete. When the ink charging process is finished, the printer returns the print head to its home position and the  power light stops flashing.



Caution:

The  power light continues to flash while the printer performs the ink charging operation. Never turn off the printer while this light is flashing. Doing so can result in incomplete charging of ink.

10. Close the printer cover.

Maintenance

Checking the Print Head Nozzles

If you find that the printed image is unexpectedly faint or dots in the printed image are missing, you may be able to identify the problem by checking the print head nozzles.

You can check the print head nozzles from your computer with the Nozzle Check utility in the printer software, or from the printer itself by using the printer's control panel buttons.

Using the Nozzle Check utility

Note:

Do not use the Nozzle Check utility while printing is in progress; otherwise your printout may be marred.



For Windows users

1. Make sure A4 or Letter size paper is loaded in the sheet feeder.
2. Click the Utility tab in the printer software window, then click the Nozzle Check button.
3. Follow the instructions on your screen.

For Macintosh users

1. Make sure A4 or Letter size paper is loaded in the sheet feeder.
2. Click the  Utility icon button in the Print or Page Setup dialog box, then click the Nozzle Check button.
3. Follow the messages on your screen.

Using the control panel buttons

1. Make sure that A4 or Letter size paper is loaded in the sheet feeder.
2. Hold down the  load/eject button (① in the illustration below) and press the  power button (② in the illustration below) to turn on the printer. Then release both buttons.

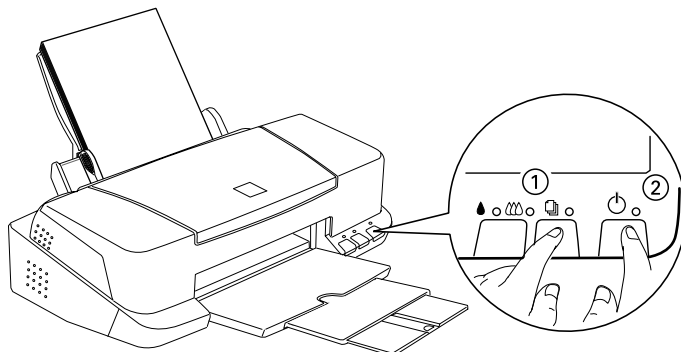

The printer prints an operation check page including your printer's ROM version information, the ink counter code, and a nozzle check pattern. Here are sample printouts.

Good sample

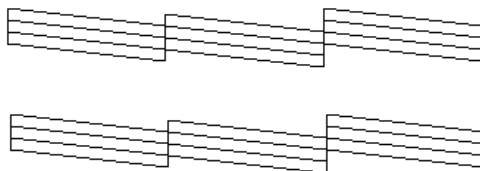

Print head needs to be cleaned

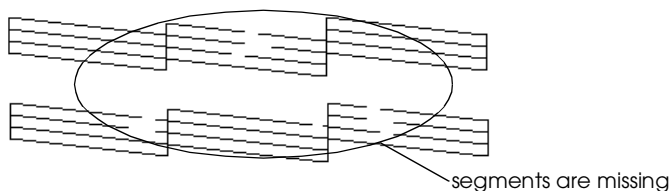

The above sample is in black and white, but the actual test prints in color (CMYK).



If the nozzle check page does not print satisfactorily (for example, if any segment of the printed lines is missing) there is a problem with the printer. This could be a clogged ink nozzle or a misaligned print head. See the next section for details on cleaning the print head. For information on aligning the print head, see “Aligning the Print Head” on page 48.

Cleaning the Print Head

If you find that the printed image is unexpectedly faint or dots in the printed image are missing, you may be able to solve these problems by cleaning the print head, which ensures that the nozzles are delivering ink properly.



You can clean the print head from your computer with the Head Cleaning utility in the printer software, or from the printer itself by using the printer's control panel buttons.

Note:



- ❑ *Print head cleaning uses both color and black ink. To avoid wasting ink, clean the print head only if print quality declines; for example, if the printout is blurry or the color is incorrect or missing.*
- ❑ *Use the Nozzle Check utility to confirm that the print head needs to be cleaned. This saves ink.*
- ❑ *When the  black or  color ink out light is flashing or on, you cannot clean the print head. Replace the appropriate ink cartridge first.*
- ❑ *Do not start the Head Cleaning or Nozzle Check utility while printing is in progress; otherwise your printout may be marred.*

Using the Head Cleaning utility

For Windows users



1. Make sure that both  black and  color ink out lights are off.

Note:

If the  black or  color ink out light is flashing, you can not clean the print head. Replace the appropriate ink cartridge first.



2. Click the Utility tab in the printer software window, then click the Head Cleaning button.
3. Follow the messages on your screen.

For Macintosh users



1. Make sure that the printer is on, and the  black and  color ink out lights are off.

2. Click the  Utility icon button in the Print or Page Setup dialog box, then click the Head Cleaning button.
3. Follow the on-screen messages.

Using the control panel buttons

1. Make sure that the  power light is on and that both the  black and  color ink out lights are off.

Note:

If the  black or  color ink out light is flashing or on, you cannot clean the head, and this operation will start the ink cartridge replacement procedure. If you do not want to replace an ink cartridge at this moment, press the  cleaning button to return the print head to its home position.

2. Hold down the  cleaning button for three seconds.

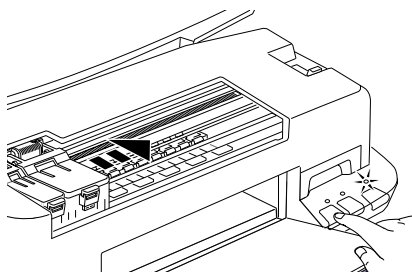

The printer starts cleaning the print head and the  power light begins flashing. Print head cleaning takes about thirty seconds to complete.



Caution:

Never turn off the printer while the  power light is flashing. Doing so may damage the printer.

3. When the  power light stops flashing, print a few lines from a document to confirm that the head is clean and to reset the cleaning cycle.

If print quality hasn't improved after repeating this procedure four or five times, turn the printer off and leave it alone overnight. Then do the head cleaning again.

If the print quality still has not improved, one or both of your ink cartridges may be old or damaged and may need to be replaced. To replace an ink cartridge before it is empty, see "Replacing Ink Cartridges" in the online *Reference Guide*.

If print quality remains a problem after replacing the ink cartridges, contact your dealer.

Note:

To maintain print quality, we recommend turning on the printer for at least one minute every month.

Aligning the Print Head

If you notice a misalignment of vertical lines, you may be able to solve this problem from your computer using the Print Head Alignment utility in your printer software.

Note:

Do not start the Print Head Alignment utility while printing is in progress; otherwise, your printout may be marred.

For Windows users

1. Make sure A4 or Letter size plain paper is loaded in the sheet feeder.
2. Click the Utility tab in the printer software window, then click the Print Head Alignment button.

3. Follow the messages on your screen to align the print head.

For Macintosh users

1. Make sure A4 or Letter size plain paper is loaded in the sheet feeder.
2. Click the  Utility icon button in the Print or Page Setup dialog box, then click the Print Head Alignment button.
3. Follow the messages on your screen to align the print head.

Troubleshooting

Can not install the USB Printer Driver

Make sure your computer is a Windows 98 pre-installed model

Your computer must be a Windows 98 pre-installed model. You may not be able to install or run the USB Printer Driver on a computer which is not equipped with a USB port or which is upgraded from Windows 95 to 98.

For details about your computer, contact your dealer.

Make sure that EPSON USB Printer Devices appears in the Device Manager menu

If you canceled the plug-and-play driver installation before the procedure was completed, either the USB printer device driver or the printer driver may be incorrectly installed.

Follow the steps below to check the installation and reinstall the drivers.

1. Turn the printer on. Plug the USB cable into the printer and the computer.
2. Right-click the My Computer icon on your desktop, then click Properties.
3. Click the Device Manager tab.

If your drivers are correctly installed, EPSON USB Printer Devices should appear in the Device Manager menu.

If EPSON USB Printer Devices does not appear in the Device Manager menu, click the plus (+) sign beside Other Devices to view the installed devices. If USB Printer appears under Other Devices, the USB printer device driver is not installed correctly. If EPSON Stylus COLOR 760 appears, the printer driver is not installed correctly.

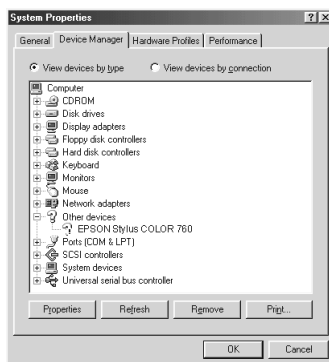
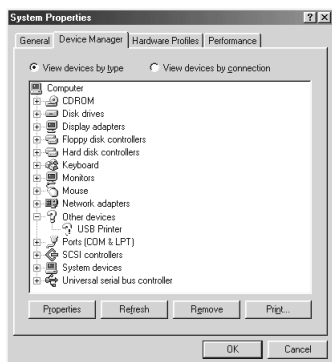

If neither USB Printer nor EPSON Stylus COLOR 760 appears under Other Devices, click Refresh or unplug the USB cable from the printer, then plug it into the printer again.

4. Under Other Devices, click USB Printer or EPSON Stylus COLOR 760, then click Remove. Then click OK.

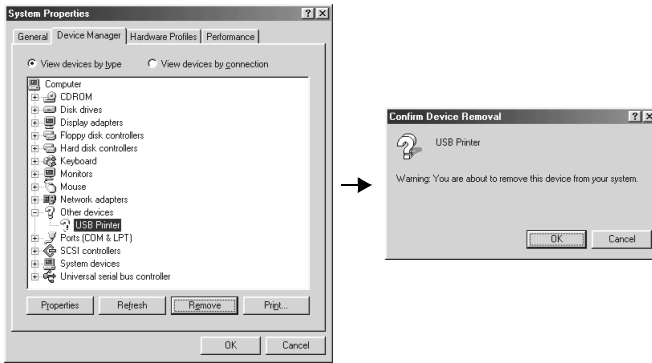











5. Unplug the USB cable from the printer, then plug it into the printer again.
6. The following dialog box appears. Install the driver again, following the instructions in the Setup Guide.



Error Indicators

You can identify many common printer problems with the lights on your printer's control panel. If your printer stops working and the lights are on or flashing, use the following table of panel light patterns to diagnose the problem, then follow the recommended corrective measures.

Lights	Problem and Solution	
	Paper Out	
	No paper is loaded in the printer.	Load paper in the sheet feeder; then press the  load/eject button. The printer resumes printing and the light goes out.
	Paper Jam	
	Paper has jammed in the printer.	Press the  load/eject button. The printer ejects the jammed paper and then resumes printing. If the error is not cleared, open the printer cover and remove the jammed paper. Then reload paper in the sheet feeder and press the  load/eject button. The printer resumes printing.
	Ink Low (black ink cartridge)	
	The black ink cartridge is nearly empty.	Obtain a replacement black ink cartridge (S020189).
	Ink Out (black ink cartridge)	
	The black ink cartridge is empty.	Replace the black ink cartridge with a new one (S020189). See "Replacing Ink Cartridges" on page 37.
	Ink Low (color ink cartridge)	
	The color ink cartridge is nearly empty.	Obtain a replacement color ink cartridge (S020191).

	Ink Out (color ink cartridge)	
	<p>The color ink cartridge is empty.</p>	<p>Replace the color ink cartridge with a new one (S020191). See "Replacing Ink Cartridges" on page 37.</p>
	Carriage Error	
	<p>The print head carriage is obstructed by jammed paper or other foreign material and cannot return to the home position.</p>	<p>Turn off the printer. Open the printer cover and remove any paper from the paper path by hand. Then turn the printer back on.</p> <p>If the error is not cleared, contact your dealer.</p>
	Fatal Error	
	<p>The yellow tape seal has not been removed from the ink cartridge.</p>	<p>Turn off the printer, then turn it on again. The ink out lights come on and the print head moves left. Replace the ink cartridge with a new one. If the fatal error occurs again after turning on the printer, contact your dealer.</p>
	Unknown Printer Error	
	<p>An unknown printer error has occurred.</p>	<p>Turn off the printer, and contact your dealer.</p>

● = on, ○ = off, ◌ = flashing

Typical Problems and Solutions

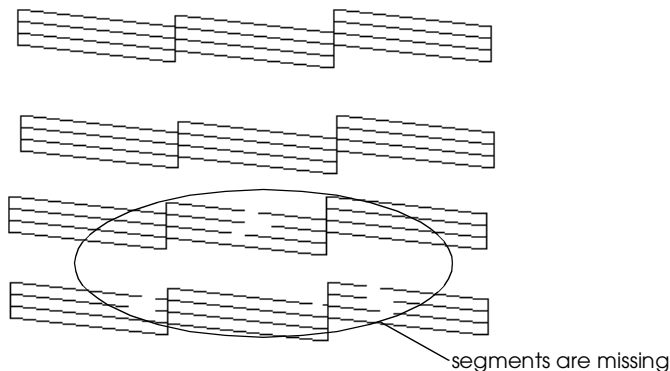

Most printer problems have simple solutions. Find the problem in the list below and apply the recommended solution. For more information, see “Troubleshooting” in the online *Reference Guide*.

Print quality problems

If you are having print quality problems, try the solutions offered here.

Horizontal banding



- Make sure the printable side of the paper is face up in the sheet feeder.
- Run the Head Cleaning utility to clear any clogged ink nozzles.

Vertical misalignment

- Make sure the printable side of the paper is face up in the sheet feeder.
- Run the Print Head Alignment utility.

- ❑ Turn off the High Speed setting in your printer driver. For instructions, see the printer driver's online help for Windows. For Macintosh, see "Using the Advanced settings" in the online *Reference Guide*.

Color gaps

- ❑ Make sure your paper is not damaged, dirty, or too old.
- ❑ Run the Head Cleaning utility to clear any clogged ink nozzles.
- ❑ Check the  black and  color ink out lights. If a light is flashing, replace the ink cartridge. See "Replacing Ink Cartridges" on page 37.

Blurry or smeared printout

Try one or more of these solutions.

- ❑ Make sure the printable side of the paper is face up in the sheet feeder.
- ❑ Make sure your paper is not damaged, dirty, or too old.
- ❑ Set the adjust lever to the "+" position, and make sure the Media Type setting is set correctly in your printer driver.

Paper feed or paper jam problems

If the printer doesn't feed paper, feeds multiple pages, or the paper is jammed, remove and reload the stack of paper, then press the load/eject button. Also check the following:

- ❑ The paper isn't old or creased.
- ❑ Paper isn't loaded above the arrow on the left edge guide.
- ❑ The edge guides are set correctly.

- ❑ The paper isn't too thin or rough. Use paper that meets the paper requirements for this printer. See the online *Reference Guide* for paper specifications.

Printer does not work correctly with the USB

If your printer does not work correctly with a USB cable, try one or more of these solutions:

- ❑ Use the recommended USB cable as described in "System Requirements" on page 220
- ❑ If you use a USB hub, connect the printer to the first tier of the hub, or connect the printer to the computer's USB port directly.
- ❑ For PC's, try reinstalling the USB Printer Device Driver and the printer software. First, uninstall the EPSON Printer Software using Add/Remove Programs in the Control Panel, then uninstall the EPSON USB Printer Devices. Next, re-install the software as described in Setup Guide. If EPSON USB Printer Devices is not registered in the Add/Remove Programs list, access the CD-ROM and double-click epusbun.exe. Then follow the onscreen instructions.

Cancelling Printing

If the printouts are not what you expected and display incorrect or garbled characters or images, you may need to cancel printing. To cancel printing, follow the steps below.

For Windows 95, 98 and NT 4.0

When you send a print job to the printer, the Progress Meter appears on your computer screen.

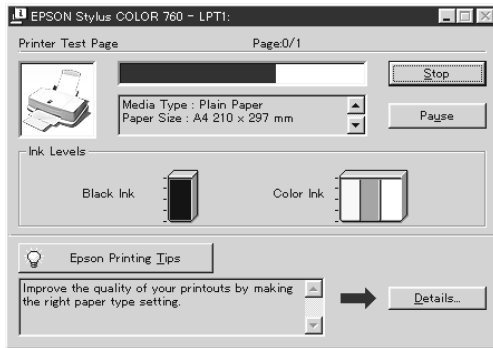

Click the Stop button to cancel printing.

For Windows 3.1

When you send a print job to the printer, the Despooler appears on your screen.



Click the  Stop button to cancel printing.

For Macintosh

When background printing is on

1. Select EPSON Monitor3 from the application menu.
2. Press the power button to turn off the printer.



3. Click on the document which is printing, then click the  Stop icon button to cancel the print job.

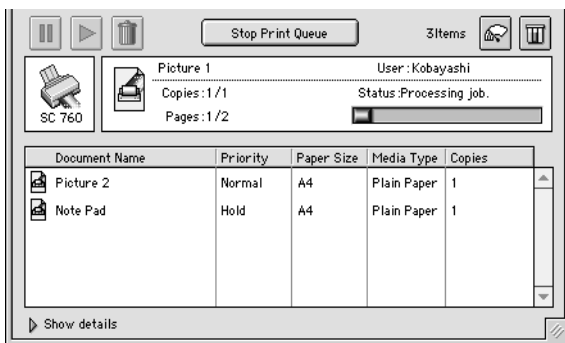

When background printing is off

1. Press the  power button to turn off the printer.
2. Hold down the command key on your keyboard and press the period (.) key to cancel the print job.

Where to Get Help

If your printer is not operating properly and you cannot solve the problem using the troubleshooting information in your printer documentation, contact customer support services for assistance.

Customer support will be able to help you much more quickly if you give them the following information.

- Serial number of your printer
(The serial number label is on the back of the printer.)
- Printer model
- Brand and model of your computer
- Printer software version
(Click About in your printer driver.)
- Windows version you are using
- Software application(s) you normally use with your printer and their version number(s)

For United Kingdom and the Republic of Ireland Users

If you purchased your product in the UK or the Republic of Ireland, EPSON (UK) LTD provides a range of customer services and technical support.

Support Via the World Wide Web

- For information on the latest EPSON products, software drivers, on-line user guides and answers to frequently asked questions:
<http://www.epson.co.uk>
- To email EPSON Technical Support:
<http://www.epson.co.uk/support/email/>

- ❑ For a full list of EPSON Customer and Warranty Support services:
<http://www.epson.co.uk/support/>

Support Via Telephone

Our Customer and Warranty Support teams can be contacted by calling 0870 163 7766 in the UK or 0044 0870 163 7766 from the Republic of Ireland. They can provide the following services:

- ❑ Technical information on installing, configuring and operating your EPSON products
- ❑ Arranging for faulty EPSON products to be repaired within the warranty period

Pre Sales Enquiry Desk

Our Enquiry Desk team can be contacted by calling 0800 220546 in the UK or 1 800 409132 from the Republic of Ireland, by faxing 01442 227271 in the UK or 0044 1442 227271 from the Republic of Ireland, and via Email at info@epson.co.uk. They can provide the following information:

- ❑ Pre sales information and literature on new EPSON products (also available via our world wide web site at <http://www.epson.co.uk>)
- ❑ Where to purchase genuine EPSON consumables, accessories, and options

For Australian Users

EPSON Australia wishes to provide you with a high level of Customer Service. As well as the user's guide, we provide the following sources for obtaining information:

EPSON FAXBACK

EPSON FAXBACK will fax you the latest specifications and pricing for most EPSON products offered in Australia. There is also technical information including details of the latest software and drivers available. Phone (02) 9903 9075 and the system will guide you through a number of choices before faxing the information to your fax machine.

EPSON Bulletin Board System

This is where you can download the latest software and drivers. Visit the BBS to check out the latest versions. If you have a modem, phone (02) 9417 5090.

Internet URL <http://www.epson.com.au>

Access the EPSON Australia World Wide Web pages. Worth taking your modem here for the occasional surf! You can get the same information as offered on the EPSON FAXBACK and the EPSON Bulletin Board plus more.

Your dealer

Don't forget that your dealer can often help identify and resolve problems. The dealer should always be the first call for advice on problems. They can often solve problems quickly and easily as well as give you advice on the next step to take.

EPSON Helpdesk

EPSON Helpdesk is provided as a final backup to make sure our clients have access to advice. Operators on the Helpdesk can aid you in diagnosing hardware and software problems. They can also advise you on the latest EPSON products and where the nearest dealer or service agent is located. Many types of queries are answered here.

The Helpdesk numbers are:

Phone: (02) 9903 9040

Fax: (02) 9903 9189

We encourage you to have all the relevant information on hand when you ring. The more information you prepare, the faster we can help solve the problem. This information includes the *User's Guide* for your EPSON product, type of computer, operating system, application programs, and any other information you feel is required.

For Singapore Users

Contact the telephone and fax numbers below:

Phone: (065) 337-7911

Fax: (065) 334-1185

For Hong Kong Users

To obtain technical support as well as other after-sales services, users are welcome to contact EPSON Hong Kong Limited.

Internet home page

EPSON Hong Kong has established a local home page in both Chinese and English on the Internet to provide users with the following information:

- Product information
- Answers to Frequently Asked Questions (FAQs)
- Latest versions of EPSON printer drivers

Users can access our World Wide Web home page at:
<http://www.epson.com.hk>

Electronic bulletin board system

An electronic bulletin board system (BBS) is also available to obtain printer information and the latest versions of printer drivers. You can log on to the following number for the BBS service:

BBS: (852) 2827-4244

Technical Support Hotline

You can also contact our technical staff at the following telephone and fax numbers:

Phone: (852) 2585-4399

Fax: (852) 2827-4383

For Philippines Users

To obtain technical support as well as other after sales services, users are welcome to contact the EPSON Philippines Representative Office at the telephone and fax numbers below:

Phone: (632) 813-6552

Fax: (632) 813-6545

BBS: (632) 814-0595

Options and Consumable Products

Options

The following interface cables and interface cards are available for your printer.

Interface cables

EPSON supplies the following interface cable. However, you can use any interface cable that meets these specifications. See your computer manual for any additional requirements.

- ❑ Parallel Interface Cable (shielded) C83602* from D-SUB 25-pin (computer) to 36-pin Amphenol 57 Series (printer)
- ❑ USB Interface Cable (shielded) C83623* from Series A 4-pin (computer) to Series B 4-pin (printer) (This cable is not supplied in all locations.)

Note:

The asterisk () is a substitute for the last digit of the product number, which varies by location.*



Caution:

Use only interface cables which meet the specifications listed above. Using other cables not covered by EPSON warranties may cause the printer to malfunction.

Consumable products

The following ink cartridges and EPSON special media are available for your printer.

Ink cartridges

You can use the following cartridges with your printer.

Black ink cartridge S020189

Color ink cartridge S020191

Note:

The product numbers of ink cartridges vary by location.

EPSON special media

EPSON offers specifically designed media for ink jet printers to meet most high-quality printing needs.

EPSON Premium Ink Jet Plain Paper (A4) S041214

EPSON 360 dpi Ink Jet Paper (A4) S041059
S041025

EPSON 360 dpi Ink Jet Paper (Letter) S041060
S041028

EPSON Photo Quality Ink Jet Paper (A4) S041061
S041026

EPSON Photo Quality Ink Jet Paper (Letter) S041062
S041029

EPSON Photo Quality Ink Jet Paper (Legal) S041067
S041048

EPSON Photo Quality Ink Jet Card (A6) S041054

EPSON Photo Quality Ink Jet Card (5 × 8") S041121

EPSON Photo Quality Ink Jet Card (8 × 10") S041122

EPSON Photo Quality Self Adhesive Sheet (A4) S041106

EPSON Ink Jet Note Cards A6
(with envelopes) S041147

EPSON Ink Jet Greeting Cards 5 × 8"
(with envelopes) S041148

EPSON Ink Jet Greeting Cards 8 × 10"
(with envelopes) S041149

EPSON Photo Quality Glossy Film (A4) S041071

EPSON Photo Quality Glossy Film (Letter)	S041072
EPSON Photo Quality Glossy Film (A6)	S041107
EPSON Ink Jet Transparencies (A4)	S041063
EPSON Ink Jet Transparencies (Letter)	S041064
EPSON Photo Paper (A4)	S041140
EPSON Photo Paper (Letter)	S041141
EPSON Photo Paper (4 × 6")	S041134
EPSON Photo Paper (100 × 150 mm)	S041255
EPSON Photo Paper (200 × 300 mm)	S041254
EPSON Photo Paper Cards (A4)	S041177
EPSON Photo Stickers 16 (A6)	S041144
EPSON Photo Stickers 4 (A6)	S041176
EPSON Panoramic Photo Paper (210 × 594 mm)	S041145
EPSON Iron-On Cool Peel Transfer Paper (A4)	S041154
EPSON Iron-On Cool Peel Transfer Paper (Letter)	S041153 S041155
EPSON Matte Paper-Heavyweight (A4)	S041256 S041258 S041259
EPSON Matte Paper-Heavyweight (Letter)	S041257

Note:

The availability of special media varies by location.

EPSON OVERSEAS MARKETING LOCATIONS

EPSON AMERICA, INC.

20770 Madrona Ave.
P.O. Box 2842
Torrance, CA 90509-2842
Phone: (800) 922-8911
Fax: (310) 782-5220

EPSON UK LTD.

Campus 100, Maylands Avenue,
Hemel Hempstead, Herts,
HP2 7TJ, U.K.
Phone: (+44) 01442 261144
Fax: (+44) 01442 227227

EPSON DEUTSCHLAND GmbH

Zülpicher Straße 6,
40549 Düsseldorf Germany
Phone: (0211) 56030
Fax: (0211) 5047787

EPSON FRANCE S.A.

68 bis, rue Marjolin
92300, Levallois-Perret, France
Phone: 33.1.40.87.37.37
Telex: 610657

EPSON AUSTRALIA PTY. LTD.

70 GIBBES STREET, CHATSWOOD 2067 NSW.
Phone: 2-9903-9000
Fax: 2-9903-9177

EPSON SINGAPORE PTE. LTD.

No. 1 Temasek Avenue #36-00
Millenia Tower, Singapore 039192
Phone: (065) 33 77 911
Fax: (065) 33 41 185

EPSON HONG KONG LTD.

Rooms 4706-10, 47/F,
China Resources Bldg.,
26 Harbour Road, Wanchai, Hong Kong
Phone: 2585-4300
Fax: 2827-7083

EPSON TAIWAN TECHNOLOGY & TRADING LTD.

10F, No. 287 Nanking E. Road, Sec. 3,
Taipei, Taiwan, R.O.C.
Phone: (02) 717-7360
Fax: (02) 712-9164

EPSON ITALIA S.p.A.

V.le F.lli Casiraghi 427
20099 Sesto S.Giovanni
MI, Italy
Phone: 2-262331
Fax: 2-2440750

EPSON IBERICA S.A.

Av. de Roma, 18-26
08290 Cerdanyola del Valles
Barcelona, Spain
Phone: 582. 15.00
Fax: 582. 15.55

**SEIKO EPSON CORPORATION
(Hirooka Office)**

80 Harashinden, Hirooka
Shiojiri-shi, Nagano-ken
399-0785 Japan

EPSON PORTUGAL, S.A.

R. do Progresso, 471, 1° Perafita
4460 Matosinhos, Portugal
Phone: (02) 996 14 02
Fax: (02) 996 14 11

EPSON

Color Ink Jet Printer

EPSON STYLUS™ COLOR 760

Daily Use

Printed in the U.K.
18/08/1999