

# ET-M1170 Series / M1170 Series **User's Guide**

## Contents

### About This Manual

Introduction to the Manuals. . . . .	5
Using the Manual to Search for Information. . . . .	5
Marks and Symbols. . . . .	6
Descriptions Used in this Manual. . . . .	7
Operating System References. . . . .	7

### Important Instructions

Safety Instructions. . . . .	8
Safety Instructions for Ink. . . . .	8
Printer Advisories and Warnings. . . . .	9
Advisories and Warnings for Setting Up the Printer. . . . .	9
Advisories and Warnings for Using the Printer. . . . .	9
Advisories and Warnings for Transporting or Storing the Printer. . . . .	10
Advisories and Warnings for Using the Printer with a Wireless Connection. . . . .	10
Protecting Your Personal Information. . . . .	10

### Printer Basics

Part Names and Functions. . . . .	11
Control Panel. . . . .	13
Buttons and Functions. . . . .	13
Lights and Printer Status. . . . .	14

### Network Settings

Network Connection Types. . . . .	17
Ethernet Connection. . . . .	17
Wi-Fi Connection. . . . .	17
Wi-Fi Direct (Simple AP) Connection. . . . .	18
Connecting to a Computer. . . . .	18
Connecting to a Smart Device. . . . .	19
Making Wi-Fi Settings from the Printer. . . . .	19
Making Wi-Fi Settings by Push Button Setup. . . . .	20
Making Wi-Fi Settings by PIN Code Setup (WPS). . . . .	21
Making Wi-Fi Direct (Simple AP) Connection Settings. . . . .	22
Checking the Network Connection Status. . . . .	23
Checking the Network Status Using Network Light. . . . .	23
Printing a Network Connection Report. . . . .	23
Printing a Network Status Sheet. . . . .	29

Replacing or Adding New Wireless Routers. . . . .	29
Changing the Connection Method to a Computer. . . . .	30
Restoring the Network Settings from the Control Panel. . . . .	31

### Preparing the Printer

Loading Papers. . . . .	32
Available Paper and Capacities. . . . .	32
Loading Paper in the Paper Cassette. . . . .	35
Loading Paper in the Rear Paper Feed Slot. . . . .	38
Loading Envelopes and Precautions. . . . .	40
List of Paper Type. . . . .	40
Outputting Paper. . . . .	41
Saving Power. . . . .	41
Saving Power - Windows. . . . .	41
Saving Power - Mac OS. . . . .	42

### Printing

Printing from the Printer Driver on Windows. . . . .	43
Accessing the Printer Driver. . . . .	43
Printing Basics. . . . .	43
Printing on 2-Sides. . . . .	45
Printing Several Pages on One Sheet. . . . .	46
Printing and Stacking in Page Order (Reverse Order Printing). . . . .	46
Printing a Reduced or Enlarged Document. . . . .	47
Printing One Image on Multiple Sheets for Enlargement (Creating a Poster). . . . .	47
Printing with a Header and Footer. . . . .	53
Printing a Watermark. . . . .	54
Printing Multiple Files Together. . . . .	54
Adjusting the Print Tone. . . . .	55
Printing to Emphasize Thin Lines. . . . .	56
Printing to Enhance Light Text and Lines. . . . .	56
Printing Clear Bar Codes. . . . .	57
Canceling Printing. . . . .	57
Menu Options for the Printer Driver. . . . .	57
Printing from the Printer Driver on Mac OS. . . . .	60
Printing Basics. . . . .	60
Printing on 2-Sides. . . . .	62
Printing Several Pages on One Sheet. . . . .	63
Printing and Stacking in Page Order (Reverse Order Printing). . . . .	63
Printing a Reduced or Enlarged Document. . . . .	64
Canceling Printing. . . . .	64
Menu Options for the Printer Driver. . . . .	65

## Contents

Making Operation Settings for the Mac OS Printer Driver. . . . .	66
Printing from Smart Devices. . . . .	67
Using Epson iPrint. . . . .	67
Using Epson Print Enabler. . . . .	68
Canceling Printing - Printer Button. . . . .	69

### **Refilling Ink and Replacing Maintenance Boxes**

Checking the Status of the Remaining Ink and the Maintenance Box. . . . .	70
Checking the Status of the Maintenance Box - Windows. . . . .	70
Checking the Status of the Maintenance Box - Mac OS X. . . . .	70
Ink Bottle Codes. . . . .	70
Ink Bottle Handling Precautions. . . . .	72
Refilling the Ink Tank. . . . .	73
Maintenance Box Code. . . . .	76
Maintenance Box Handling Precautions. . . . .	76
Replacing a Maintenance Box. . . . .	76

### **Maintaining the Printer**

<b>Preventing the Print Head from Drying. . . . .</b>	<b>79</b>
<b>Check if Nozzles are Clogged (Nozzle Check). . . . .</b>	<b>79</b>
Check if Nozzles are Clogged (Nozzle Check) - Printer Buttons. . . . .	79
Check if Nozzles are Clogged (Nozzle Check) - Windows. . . . .	80
Check if Nozzles are Clogged (Nozzle Check) - Mac OS. . . . .	81
Cleaning the Print Head (Head Cleaning). . . . .	82
Cleaning the Print Head - Printer Buttons. . . . .	82
Cleaning the Print Head - Windows. . . . .	82
Cleaning the Print Head - Mac OS. . . . .	83
Power Cleaning the Print Head (Power Cleaning). . . . .	83
Running Power Cleaning - Windows. . . . .	84
Running Power Cleaning - Mac OS. . . . .	84
Aligning the Print Head. . . . .	85
Aligning the Print Head - Windows. . . . .	85
Aligning the Print Head - Mac OS. . . . .	85
Cleaning the Paper Path. . . . .	85
Cleaning the Paper Path - Windows. . . . .	85
Cleaning the Paper Path - Mac OS X. . . . .	86
Cleaning the Paper Path for Paper Feeding Problems. . . . .	86
Cleaning the Translucent Film. . . . .	88

Checking the Total Number of Pages Fed Through the Printer. . . . .	89
Checking the Total Number of Pages Fed Through the Printer - Printer Buttons. . . . .	89
Checking the Total Number of Pages Fed Through the Printer - Windows. . . . .	90
Checking the Total Number of Pages Fed Through the Printer - Mac OS. . . . .	90

### **Network Service and Software Information**

Application for Configuring Printer Operations (Web Config). . . . .	91
Running Web Config on a Web Browser. . . . .	91
Running Web Config on Windows. . . . .	92
Running Web Config on Mac OS. . . . .	92
Application for Printing Web Pages (E-Web Print). . . . .	92
Software Update Tools (EPSON Software Updater). . . . .	93
Installing the Latest Applications. . . . .	93
Updating Applications and Firmware. . . . .	94
Uninstalling Applications. . . . .	95
Uninstalling Applications - Windows. . . . .	95
Uninstalling Applications - Mac OS. . . . .	96
Printing Using a Network Service. . . . .	96

### **Solving Problems**

Checking the Printer Status. . . . .	98
Lights and Printer Status. . . . .	98
Checking the Printer Status - Windows. . . . .	100
Checking the Printer Status - Mac OS. . . . .	101
Checking the Software Status. . . . .	101
Removing Jammed Paper. . . . .	101
Removing Jammed Paper from the Front Cover	101
Removing Jammed Paper from the Rear Paper Feed Slot. . . . .	103
Removing Jammed Paper from Inside the Printer. . . . .	103
Removing Jammed Paper from Rear Cover. . . . .	104
Paper Does Not Feed Correctly. . . . .	105
Paper Jams. . . . .	105
Paper Feeds at a Slant. . . . .	106
Ejected Paper Falls from the Output Tray. . . . .	106
Paper is Ejected During Printing. . . . .	106
Power and Control Panel Problems. . . . .	106
Power Does Not Turn On. . . . .	106
Power Does Not Turn Off. . . . .	106
Power Turns Off Automatically. . . . .	106

## Contents

Cannot Print from a Computer. . . . .	107	Security Protocol. . . . .	126
Checking the Connection (USB). . . . .	107	Supported Third Party Services. . . . .	126
Checking the Connection (Network). . . . .	107	Dimensions. . . . .	126
Checking the Software and Data. . . . .	108	Electrical Specifications. . . . .	127
Checking the Printer Status from the Computer (Windows). . . . .	110	Environmental Specifications. . . . .	127
Checking the Printer Status from the Computer (Mac OS). . . . .	110	System Requirements. . . . .	128
When You Cannot Make Network Settings. . . . .	111	Regulatory Information. . . . .	128
Cannot Connect from Devices Even Though Network Settings are No Problems. . . . .	111	Standards and Approvals. . . . .	128
When You Cannot Connect Using Wi-Fi Direct (Simple AP) Connection. . . . .	113	Restrictions on Copying. . . . .	129
Checking the SSID Connected to the Printer. . . . .	114	Transporting and Storing the Printer. . . . .	130
Checking the SSID for the Computer. . . . .	115	Copyright. . . . .	132
Ethernet Connection Becomes Unstable. . . . .	116	Trademarks. . . . .	132
Printout Problems. . . . .	117	Where to Get Help. . . . .	133
Printout is Scuffed or Color is Missing. . . . .	117	Technical Support Web Site. . . . .	133
Banding or Unexpected Colors Appear. . . . .	117	Contacting Epson Support. . . . .	133
Colored Banding Appears at Intervals of Approximately 3.3 cm. . . . .	117		
Vertical Banding or Misalignment. . . . .	118		
Print Quality is Poor. . . . .	118		
Paper Is Smearred or Scuffed. . . . .	119		
Paper is Smearred During Automatic 2-Sided Printing. . . . .	120		
Printed Photos are Sticky. . . . .	120		
The Position, Size, or Margins of the Printout Are Incorrect. . . . .	120		
Printed Characters Are Incorrect or Garbled. . . . .	121		
The Printed Image Is Inverted. . . . .	121		
Mosaic-Like Patterns in the Prints. . . . .	121		
The Printout Problem Could Not be Cleared. . . . .	121		
Other Printing Problems. . . . .	121		
Printing Is Too Slow. . . . .	121		
Printing Slows Down Dramatically During Continuous Printing. . . . .	122		
Other Problems. . . . .	122		
Operation Sounds Are Loud. . . . .	122		
Application Is Blocked by a Firewall (for Windows Only). . . . .	122		
Ink Spilled. . . . .	122		
 <b>Appendix</b>			
Technical Specifications. . . . .	124		
Printer Specifications. . . . .	124		
Interface Specifications. . . . .	125		
Network Function List. . . . .	125		
Wi-Fi Specifications. . . . .	125		
Ethernet Specifications. . . . .	126		

# About This Manual

## Introduction to the Manuals

The following manuals are supplied with your Epson printer. As well as the manuals, see the help included in the various Epson software applications.

### ❑ Start Here (paper manual)

Provides you with information on setting up the printer, installing the software, using the printer, solving problems, and so on.

### ❑ User's Guide (digital manual)

This manual. Provides overall information and instructions on using the printer, on network settings when using the printer on a network, and on solving problems.

You can obtain the latest versions of the above manuals with the following methods.

### ❑ Paper manual

Visit the Epson Europe support website at <http://www.epson.eu/Support>, or the Epson worldwide support website at <http://support.epson.net/>.

### ❑ Digital manual

Start EPSON Software Updater on your computer. EPSON Software Updater checks for available updates of Epson software applications and the digital manuals, and allows you to download the latest ones.

## Related Information

➔ “Software Update Tools (EPSON Software Updater)” on page 93

## Using the Manual to Search for Information

The PDF manual allows you to search for information you are looking for by keyword, or jump directly to specific sections using the bookmarks. You can also print only the pages you need. This section explains how to use a PDF manual that has been opened in Adobe Reader X on your computer.

### Searching by keyword

Click **Edit > Advanced Search**. Enter the keyword (text) for information you want to find in the search window, and then click **Search**. Hits are displayed as a list. Click one of the displayed hits to jump to that page.

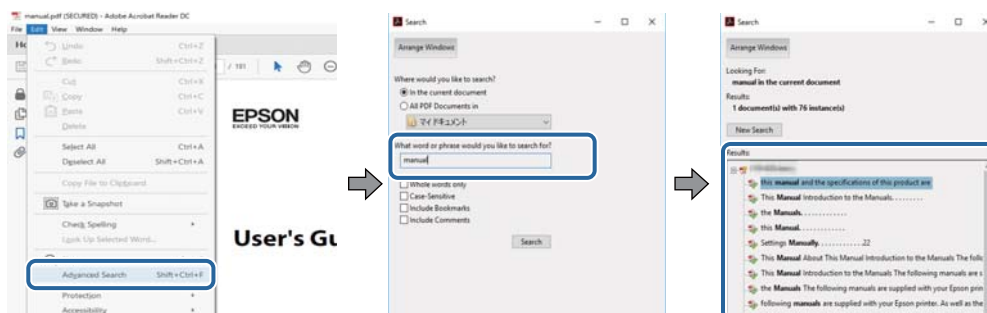

## About This Manual

### Jumping directly from bookmarks

Click a title to jump to that page. Click + or > to view the lower level titles in that section. To return to the previous page, perform the following operation on your keyboard.

- ❑ Windows: Hold down **Alt**, and then press **←**.
- ❑ Mac OS: Hold down the command key, and then press **←**.

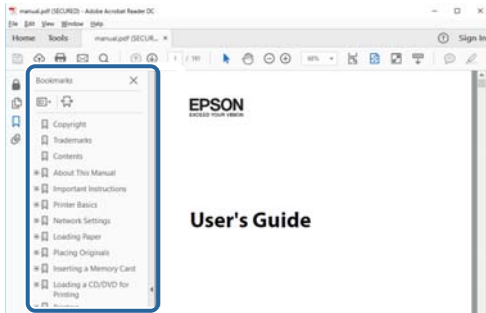

### Printing only the pages you need

You can extract and print only the pages you need. Click **Print** in the **File** menu, and then specify the pages you want to print in **Pages in Pages to Print**.

- ❑ To specify a series of pages, enter a hyphen between the start page and the end page.  
Example: 20-25
- ❑ To specify pages that are not in series, divide the pages with commas.  
Example: 5, 10, 15

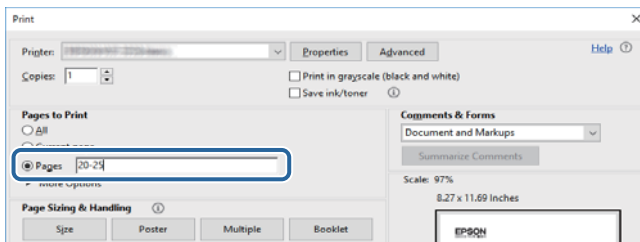

---

## Marks and Symbols



### Caution:

*Instructions that must be followed carefully to avoid bodily injury.*



### Important:

*Instructions that must be observed to avoid damage to your equipment.*

### Note:

*Provides complementary and reference information.*

## About This Manual

### Related Information

- ➔ Links to related sections.

---

## Descriptions Used in this Manual

- Screenshots of the printer driver screens are from Windows 10 or macOS High Sierra. The content displayed on the screens varies depending on the model and situation.
- Illustrations used in this manual are examples only. Although there may be slight differences depending on the model, the method of operation is the same.
- You can read the QR code using dedicated app.

---

## Operating System References

### Windows

In this manual, terms such as "Windows 10", "Windows 8.1", "Windows 8", "Windows 7", "Windows Vista", "Windows XP", "Windows Server 2016", "Windows Server 2012 R2", "Windows Server 2012", "Windows Server 2008 R2", "Windows Server 2008", "Windows Server 2003 R2", and "Windows Server 2003" refer to the following operating systems. Additionally, "Windows" is used to refer to all versions.

- Microsoft® Windows® 10 operating system
- Microsoft® Windows® 8.1 operating system
- Microsoft® Windows® 8 operating system
- Microsoft® Windows® 7 operating system
- Microsoft® Windows Vista® operating system
- Microsoft® Windows® XP operating system
- Microsoft® Windows® XP Professional x64 Edition operating system
- Microsoft® Windows Server® 2016 operating system
- Microsoft® Windows Server® 2012 R2 operating system
- Microsoft® Windows Server® 2012 operating system
- Microsoft® Windows Server® 2008 R2 operating system
- Microsoft® Windows Server® 2008 operating system
- Microsoft® Windows Server® 2003 R2 operating system
- Microsoft® Windows Server® 2003 operating system

### Mac OS

In this manual, "Mac OS" is used to refer to macOS High Sierra, macOS Sierra, OS X El Capitan, OS X Yosemite, OS X Mavericks, OS X Mountain Lion, Mac OS X v10.7.x, and Mac OS X v10.6.8.

# Important Instructions

---

## Safety Instructions

Read and follow these instructions to ensure safe use of this printer. Make sure you keep this manual for future reference. Also, be sure to follow all warnings and instructions marked on the printer.

- Some of the symbols used on your printer are to ensure safety and proper use of the printer. Visit the following Web site to learn the meaning of the symbols.  
<http://support.epson.net/symbols>
- Use only the power cord supplied with the printer and do not use the cord with any other equipment. Use of other cords with this printer or the use of the supplied power cord with other equipment may result in fire or electric shock.
- Be sure your AC power cord meets the relevant local safety standard.
- Never disassemble, modify, or attempt to repair the power cord, plug, printer unit, or options by yourself, except as specifically explained in the printer's manuals.
- Unplug the printer and refer servicing to qualified service personnel under the following conditions:  
The power cord or plug is damaged; liquid has entered the printer; the printer has been dropped or the casing damaged; the printer does not operate normally or exhibits a distinct change in performance. Do not adjust controls that are not covered by the operating instructions.
- Place the printer near a wall outlet where the plug can be easily unplugged.
- Do not place or store the printer outdoors, near excessive dirt or dust, water, heat sources, or in locations subject to shocks, vibrations, high temperature or humidity.
- Take care not to spill liquid on the printer and not to handle the printer with wet hands.
- Keep the printer at least 22 cm away from cardiac pacemakers. Radio waves from this printer may adversely affect the operation of cardiac pacemakers.

## Safety Instructions for Ink

- Be careful not to touch ink when you handle the ink tank, ink tank cap, and opened ink bottle or ink bottle cap.
  - If ink gets on your skin, wash the area thoroughly with soap and water.
  - If ink gets into your eyes, flush them immediately with water. If discomfort or vision problems continue after a thorough flushing, see a doctor immediately.
  - If ink gets into your mouth, see a doctor right away.
- Do not disassemble the maintenance box; otherwise ink may get into your eyes or on your skin.
- Do not shake an ink bottle too vigorously or subject it to strong impacts as this can cause ink to leak.
- Keep ink bottle, the ink tank unit, and maintenance box out of the reach of children. Do not allow children to drink from or handle the ink bottle and ink bottle cap.



---



## Printer Advisories and Warnings

Read and follow these instructions to avoid damaging the printer or your property. Make sure you keep this manual for future reference.

### Advisories and Warnings for Setting Up the Printer

- Do not block or cover the vents and openings in the printer.
- Use only the type of power source indicated on the printer's label.
- Avoid using outlets on the same circuit as photocopiers or air control systems that regularly switch on and off.
- Avoid electrical outlets controlled by wall switches or automatic timers.
- Keep the entire computer system away from potential sources of electromagnetic interference, such as loudspeakers or the base units of cordless telephones.
- The power-supply cords should be placed to avoid abrasions, cuts, fraying, crimping, and kinking. Do not place objects on top of the power-supply cords and do not allow the power-supply cords to be stepped on or run over. Be particularly careful to keep all the power-supply cords straight at the ends and the points where they enter and leave the transformer.
- If you use an extension cord with the printer, make sure that the total ampere rating of the devices plugged into the extension cord does not exceed the cord's ampere rating. Also, make sure that the total ampere rating of all devices plugged into the wall outlet does not exceed the wall outlet's ampere rating.
- If you plan to use the printer in Germany, the building installation must be protected by a 10 or 16 amp circuit breaker to provide adequate short-circuit protection and over-current protection for the printer.
- When connecting the printer to a computer or other device with a cable, ensure the correct orientation of the connectors. Each connector has only one correct orientation. Inserting a connector in the wrong orientation may damage both devices connected by the cable.
- Place the printer on a flat, stable surface that extends beyond the base of the printer in all directions. The printer will not operate properly if it is tilted at an angle.
- Allow space above the printer so that you can fully raise the printer cover.
- Leave enough space in front of the printer for the paper to be fully ejected.
- Avoid places subject to rapid changes in temperature and humidity. Also, keep the printer away from direct sunlight, strong light, or heat sources.

### Advisories and Warnings for Using the Printer

- Do not insert objects through the slots in the printer.
- Do not put your hand inside the printer during printing.
- Do not touch the white flat cable and ink tubes inside the printer.
- Do not use aerosol products that contain flammable gases inside or around the printer. Doing so may cause fire.
- Do not move the print head by hand; otherwise, you may damage the printer.
- Always turn the printer off using the  button. Do not unplug the printer or turn off the power at the outlet until the  light stops flashing.

## Important Instructions

- If you are not going to use the printer for a long period, be sure to unplug the power cord from the electrical outlet.

## Advisories and Warnings for Transporting or Storing the Printer

- When storing or transporting the printer, avoid tilting it, placing it vertically, or turning it upside down; otherwise ink may leak.
- Before transporting the printer, make sure that the print head is in the home (far right) position.

## Advisories and Warnings for Using the Printer with a Wireless Connection

- Radio waves from this printer may negatively affect the operation of medical electronic equipment, causing them to malfunction. When using this printer inside medical facilities or near medical equipment, follow directions from the authorized personnel representing the medical facilities, and follow all posted warnings and directions on the medical equipment.
- Radio waves from this printer may negatively affect the operation of automatically controlled devices such as automatic doors or fire alarms, and could lead to accidents due to malfunction. When using this printer near automatically controlled devices, follow all posted warnings and directions on these devices.

---

## Protecting Your Personal Information

If you give the printer to someone else or dispose of it, restore the default network settings by using the printer's buttons.

### Related Information

- ➔ [“Buttons and Functions” on page 13](#)

# Printer Basics

## Part Names and Functions

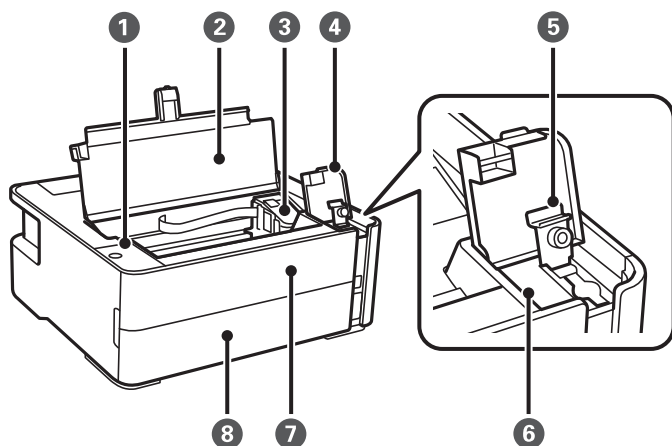

①	Control panel	Allows you to operate the printer and indicates the printer's status.
②	Printer cover	Open to remove jammed paper .
③	Print head	Ink is ejected from the print head nozzles underneath.
④	Ink tank cover	Open to refill the ink tank.
⑤	Ink tank cap	
⑥	Ink tank	Contains black ink.
⑦	Front cover	Open when removing jammed paper.
⑧	Paper cassette cover	Open to load paper in the paper cassette.

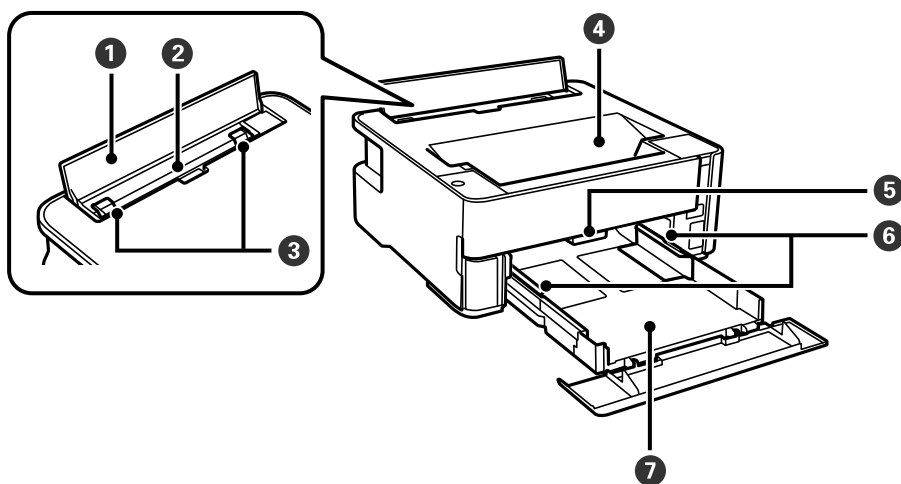

**Printer Basics**

①	Feeder guard	Prevents foreign substances from entering the printer. This cover should usually be closed.
②	Rear Paper Feed Slot	Loads paper.
③	Edge guide	Feeds the paper straight into the printer. Slide to the edges of the paper.
④	Output tray	Holds the ejected paper.
⑤	Output switch lever	Raise to output paper to the output tray. Lower to output paper facing up to the front of the printer.
⑥	Edge guide	Feeds the paper straight into the printer. Slide to the edges of the paper.
⑦	Paper cassette	Loads paper.

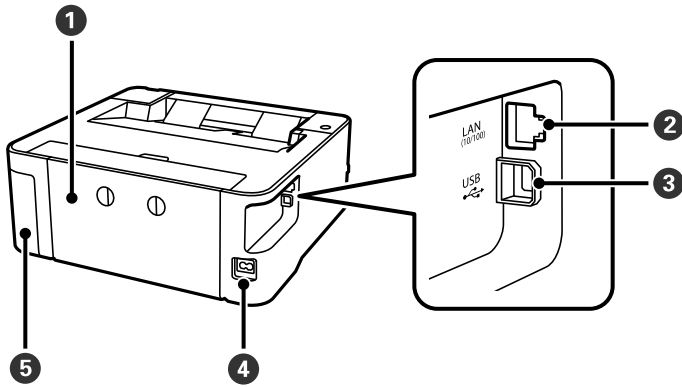

①	Rear cover	Remove when removing jammed paper.
②	LAN port	Connects a LAN cable.
③	USB port	Connects a USB cable to connect with a computer.
④	AC inlet	Connects the power cord.
⑤	Maintenance box cover	Open when replacing the maintenance box. The maintenance box is a container that collects a very small amount of surplus ink during cleaning or printing.

**Related Information**

➔ [“Control Panel” on page 13](#)





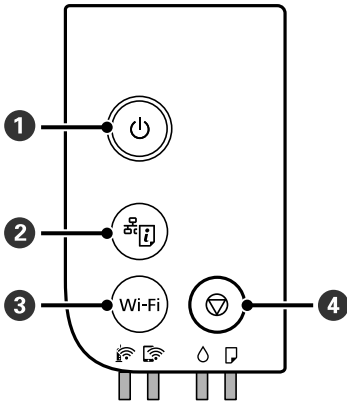



# Control Panel

## Buttons and Functions



<b>1</b>	Turns the printer on or off. Unplug the power cord after checking that the power light is off.
<b>2</b>	Prints a network connection report allowing you to determine the causes of any problems you may have using the printer on a network. If you need more detailed network settings and connection status, hold this button down for at least five seconds to print a network status sheet.
<b>3</b>	When a network error occurs, pressing this button cancels the error. Hold this button down for more than five seconds to perform Wi-Fi auto setup using the WPS push button.
<b>4</b>	Stops the current operation. Cancels paper out errors and paper jam errors.  Hold this button down for five seconds until the  button flashes to run print head cleaning.

## Functions using Button Combinations

 + Wi-Fi	<b>Wi-Fi Direct (Simple AP) Setup</b> Hold down the Wi-Fi and  buttons simultaneously to start Wi-Fi Direct (Simple AP) Setup.
Wi-Fi + 	<b>PIN Code Setup (WPS)</b> Hold down the Wi-Fi and  buttons simultaneously to start PIN Code Setup (WPS).
 + 	<b>Restore Default Network Settings</b> Turn the printer on while holding down the  button to restore the default network settings. When the network settings are restored, the printer turns on and the network status lights flash alternately.
Wi-Fi + 	Prevents changes from being made to Epson Connect and Google Connect Print settings.

## Printer Basics

	<p><b>Print Nozzle Check Pattern</b></p>
<p>Turn the printer on while holding down the  button to print the nozzle check pattern.</p>	
<p>The total number of pages fed through the printer is also printed as well as the nozzle check pattern.</p>	

## Lights and Printer Status

Lights on the control panel indicate the status of the printer.

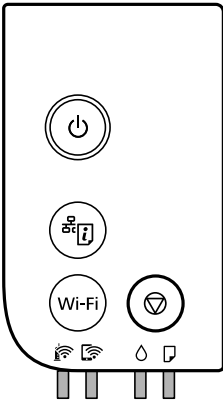

### Normal Status

: On

Light	Status
	The printer is connected to a wireless (Wi-Fi) network.
	The printer is connected to a network in Wi-Fi Direct (Simple AP) mode.

### Error Status













When an error occurs, the light turns on or flashes. Details of the error are displayed on the computer screen.

/ : On



/ : Flashing

Light	Status	Solutions
	Wi-Fi connection error has occurred.	Press the Wi-Fi button to clear the error and try again.

## Printer Basics

Light	Status	Solutions
	Initial ink charging may not be complete.	See the <i>Start Here</i> poster to complete initial ink charging.  When ink is low, initial ink charging may not be completed.
	It is time to reset the ink level.	Refill the ink tank to the upper line, and then reset the ink level.
	There is not enough ink remaining to perform cleaning.	Refill the ink tank to the upper line, and then reset the ink level before cleaning.
	It is nearly time to reset the ink level.	You can print until it is time to reset the ink level. Prepare a new ink bottle.
	The maintenance box is nearing the end of its service life.	When a message saying that you can continue printing is displayed on the computer, press the  button to continue printing. The lights stop flashing for the time being, however, they will continue to flash at regular intervals until the maintenance box is replaced.
	No paper is loaded or more than one sheet has been fed at a time.	Load paper and press the  button.
	The paper size loaded does not match the print setting.	Load the correct size paper.
	There is a problem with the printer driver.	Press the  button to cancel the print job.
	Flashing slowly (at 1.25 second intervals) A paper jam has occurred.	Remove the paper and press the  button.
	Flashing fast (at 0.5 second intervals) Paper remains inside the printer.	Load A4 size paper in the rear paper feed slot, and then press the  button to remove the paper inside. Load paper in the portrait direction.
	<ul style="list-style-type: none"> <li><input type="checkbox"/> The printer was not turned off correctly.*</li> <li><input type="checkbox"/> Because the printer was turned off while operating, the nozzles may have dried and clogged.</li> </ul> <p>* The power was turned off with a power strip or breaker, the plug was pulled out of the outlet, or an electrical failure occurred.</p>	<ul style="list-style-type: none"> <li><input type="checkbox"/> After clearing the error by pressing the  button, we recommend performing a nozzle check. Cancel any pending print jobs.</li> <li><input type="checkbox"/> To turn off the printer, make sure you press the  button.</li> </ul>
	Flashing simultaneously The printer cover is open.	Close the printer cover until it clicks.
	Flashing simultaneously The output switch lever is lowered.	Raise the output switch lever.
	Flashing simultaneously The output switch lever is raised.	Open the paper cassette cover, and then lower the output switch lever.

## Printer Basics

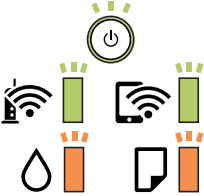
Light	Status	Solutions
	Flashing alternately A maintenance box is at the end of its service life.	The maintenance box needs to be replaced.
	Flashing alternately The maintenance box cannot be recognized.	You cannot install a maintenance box that has already been used in another printer. Install a new maintenance box.
	Flashing alternately The maintenance box is not installed.	Install the maintenance box again.
	Flashing alternately There is not enough free space left in the maintenance box to perform cleaning.	Replace the maintenance box before cleaning. You may still be able to print even if you cannot perform cleaning.
	The printer has started in recovery mode because the firmware update failed.	Follow the steps below to try to update the firmware again. <ol style="list-style-type: none"> <li>1. Connect the computer and the printer with a USB cable. (During recovery mode, you cannot update the firmware over a network connection.)</li> <li>2. Visit your local Epson website for further instructions.</li> </ol>
	A printer error has occurred.	Open the printer cover and remove any paper inside the printer. Turn the power off and on again.  If the error continues to occur after turning the power off and on again, contact Epson support.

## Related Information

- ➔ [“Removing Jammed Paper” on page 101](#)
- ➔ [“Contacting Epson Support” on page 133](#)
- ➔ [“Installing the Latest Applications” on page 93](#)



# Network Settings

---

## Network Connection Types

You can use the following connection methods.

### Ethernet Connection

Connect the printer to a hub with an Ethernet cable.

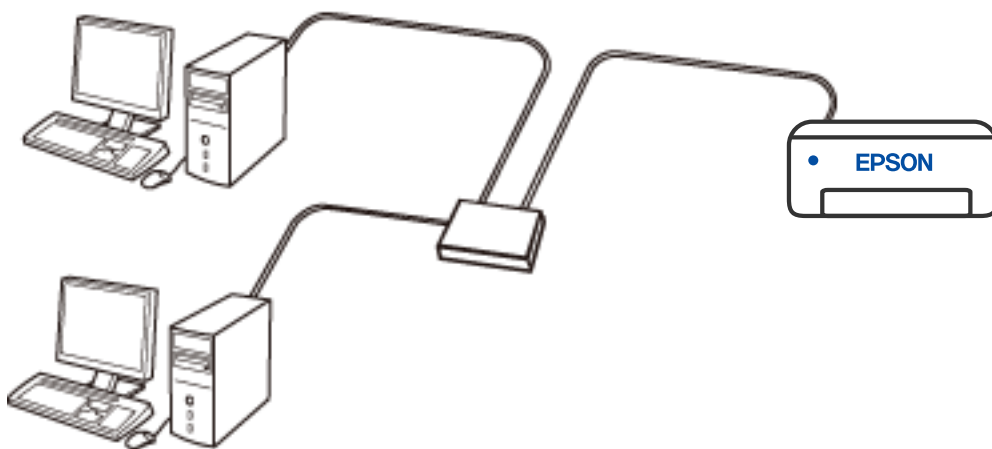

### Wi-Fi Connection

Connect the printer and the computer or smart device to the wireless router. This is the typical connection method for home or office networks where computers are connected by Wi-Fi through the wireless router.

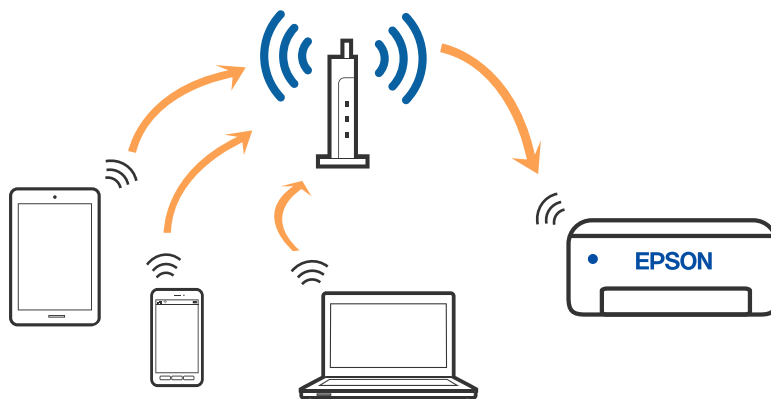

#### Related Information

➔ [“Connecting to a Computer” on page 18](#)

- ➔ “Connecting to a Smart Device” on page 19
- ➔ “Making Wi-Fi Settings from the Printer” on page 19

## Wi-Fi Direct (Simple AP) Connection

Use this connection method when you are not using Wi-Fi at home or at the office, or when you want to connect the printer and the computer or smart device directly. In this mode, the printer acts as an wireless router and you can connect the devices to the printer without having to use a standard wireless router. However, devices directly connected to the printer cannot communicate with each other through the printer.

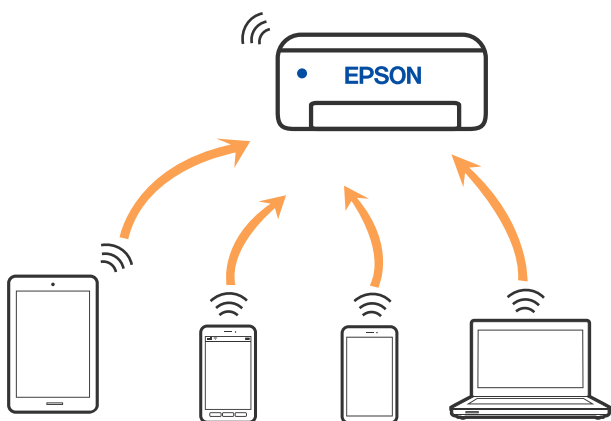

The printer can be connected by Wi-Fi or Ethernet, and Wi-Fi Direct (Simple AP) connection simultaneously. However, if you start a network connection in Wi-Fi Direct (Simple AP) connection when the printer is connected by Wi-Fi, the Wi-Fi is temporarily disconnected.

### Related Information

- ➔ “Making Wi-Fi Direct (Simple AP) Connection Settings” on page 22

---

## Connecting to a Computer

We recommend using the installer to connect the printer to a computer. You can run the installer using one of the following methods.

- Setting up from the website  
Access the following website, and then enter the product name. Go to **Setup**, and then start setting up.  
<http://epson.sn>
- Setting up using the software disc (only for the models that come with a software disc and users with Windows computers with disc drives.)  
Insert the software disc into the computer, and then follow the on-screen instructions.

### Selecting the Connection Methods

Follow the on-screen instructions until the following screen is displayed, and then select the connection method of the printer to the computer.

## Network Settings

Select the connection type and then click **Next**.

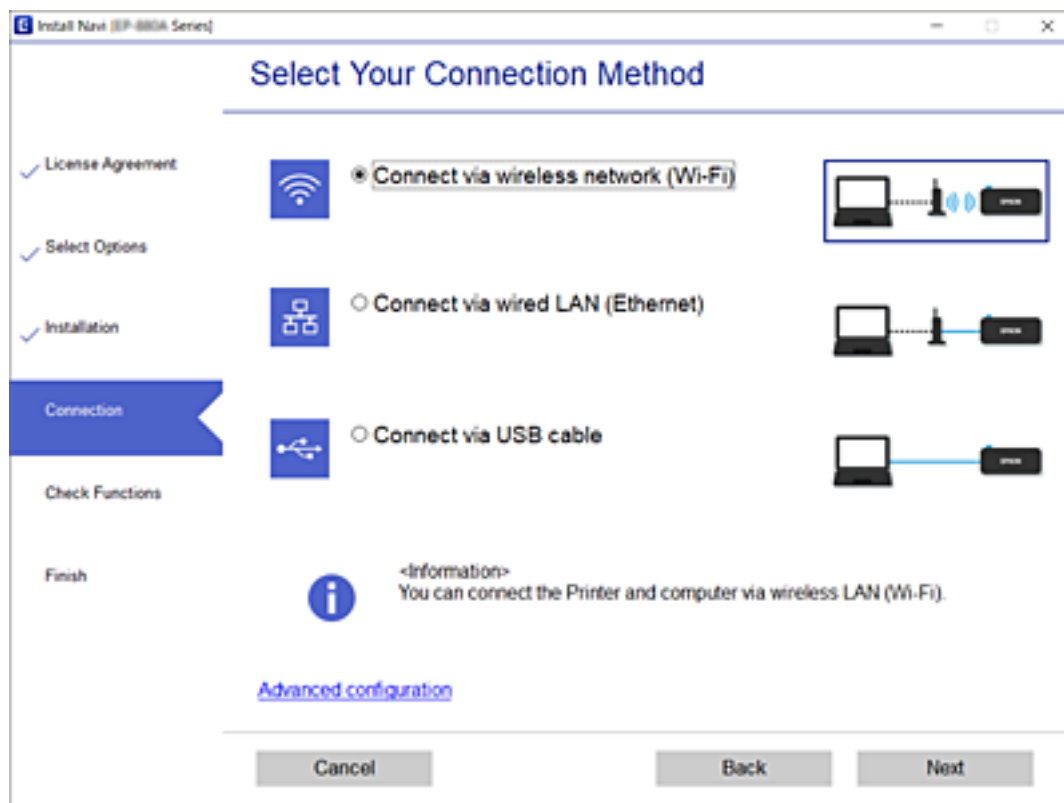

Follow the on-screen instructions.

---

## Connecting to a Smart Device

You can use the printer from a smart device when you connect the printer to the same Wi-Fi network (SSID) as the smart device. To use the printer from a smart device, set up from the following website. Access to the website from the smart device that you want to connect to the printer.

<http://epson.sn> > Setup

**Note:**

*If you want to connect a computer and a smart device to the printer at the same time, we recommend connecting the computer first by using the installer.*

---

## Making Wi-Fi Settings from the Printer

You can make network settings from the printer's control panel in several ways. Choose the connection method that matches the environment and conditions that you are using.

If the wireless router supports WPS, you can make settings by using push button setup.

After connecting the printer to the network, connect to the printer from the device that you want to use (computer, smart device, tablet, and so on.)

## Network Settings

### Related Information

- ➔ [“Making Wi-Fi Settings by Push Button Setup” on page 20](#)
- ➔ [“Making Wi-Fi Settings by PIN Code Setup \(WPS\)” on page 21](#)
- ➔ [“Making Wi-Fi Direct \(Simple AP\) Connection Settings” on page 22](#)

## Making Wi-Fi Settings by Push Button Setup

You can automatically set up a Wi-Fi network by pressing a button on the wireless router. If the following conditions are met, you can set up by using this method.



- The wireless router is compatible with WPS (Wi-Fi Protected Setup).
- The current Wi-Fi connection was established by pressing a button on the wireless router.

When the printer is connected by Ethernet, disconnect the Ethernet cable, and then start making Wi-Fi settings.

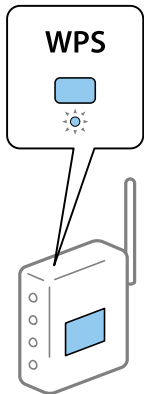
1. Hold down the [WPS] button on the wireless router until the security light flashes.



If you do not know where the [WPS] button is, or there are no buttons on the wireless router, see the documentation provided with your wireless router for details.



2. Hold down the Wi-Fi button on the printer for at least five seconds until the  light and the  light flash alternately.

The connection setting will start. When a connection is established, the  light turns on.



## Network Settings

### Note:

The printer is in a connection error status when the  light and the  light flash simultaneously. After clearing the printer error by pressing the Wi-Fi button on the printer, reboot the wireless router, place it close to the printer and try again. If it still does not work, print a network connection report and check the solution.



## Making Wi-Fi Settings by PIN Code Setup (WPS)

You can connect to an wireless router by using a PIN code that is printed on the network status sheet. You can use this method to set up if an wireless router is capable of WPS (Wi-Fi Protected Setup). Use a computer to enter a PIN code into the wireless router.



When the printer is connected by Ethernet, disconnect the Ethernet cable, and then start making Wi-Fi settings.

1. Load papers.
2. Hold down the  button on the printer for at least 5 seconds.

The network status sheet is printed.

### Note:

If you release the  button within 5 seconds, a network connection report is printed. Note that PIN code information is not printed on this report.



3. While holding down the Wi-Fi button, press the  button until the  light and the  light flash alternately.
4. Use your computer to enter the PIN code (an eight digit number) printed on [WPS-PIN Code] column of the network status sheet into the wireless router within two minutes.

When a connection is established, the  light turns on.



## Network Settings

**Note:**

- ❑ See the documentation provided with your wireless router for details on entering a PIN code.
- ❑ The printer is in a connection error status when the  light and the  light flash simultaneously. After clearing the printer error by pressing the Wi-Fi button on the printer, reboot the wireless router, place it close to the printer and try again. If it still does not work, print a network connection report and check the solution.

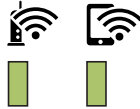

## Making Wi-Fi Direct (Simple AP) Connection Settings

This method allows you to connect the printer directly to devices without a wireless router. The printer acts as a wireless router.

1. While holding down the Wi-Fi button, press the  button until the  light and the  light flash alternately.

Wait until the process ends.

When a connection is established, the  light turns on.



**Note:**

If you enable Wi-Fi Direct once, it remains enabled unless you restore the default network settings.

2. Load papers.
3. Hold down the  button on the printer for at least 5 seconds.

The network status sheet is printed. You can check the SSID and Password for Wi-Fi Direct (Simple AP) on this sheet.

**Note:**

If you release the  button within 5 seconds, a network connection report is printed. Note that the SSID and Password for Wi-Fi Direct (Simple AP) are not printed on this report.

## Network Settings

- On the computer's network connection screen or the smart device's Wi-Fi screen, select the same SSID shown on the network status sheet to connect.



<Wi-Fi Direct>	
Wi-Fi Direct Mode	On
Communication Mode	Simple AP
Operation Mode	IEEE802.11g/n
Communication Speed	Auto
SSID	DIRECT- [REDACTED]
Password	[REDACTED]
Channel	11
Security Level	WPA2-PSK(AES)
Link Status	Unknown
Connected Devices	0 (Max [REDACTED])
Client MAC List	None

- Enter the password printed on the network status sheet into the computer or smart device.

You can confirm the status of Wi-Fi Direct on the network status sheet.

### Note:

*When you connect from a smart device using Wi-Fi Direct connection (for Android)*

When you are using an Android device and connect to the printer using Wi-Fi Direct, the  light and  light flash simultaneously on the printer.

Press the **Wi-Fi** button to allow the connection request.

Press the  button if you want to reject the connection request.

See Tips on the following website for more details.

<http://epson.sn> > Support

---

## Checking the Network Connection Status

You can check the network connection status in the following way.

### Checking the Network Status Using Network Light

You can check the network connection status using the network light on the printer's control panel.

#### Related Information

➔ [“Lights and Printer Status” on page 14](#)

### Printing a Network Connection Report

You can print a network connection report to check the status between the printer and the wireless router.

- Load papers.

## Network Settings

2. Press the  button.

The network connection report is printed.

### Related Information

- ➔ [“Messages and Solutions on the Network Connection Report” on page 24](#)

## Messages and Solutions on the Network Connection Report

Check the messages and error codes on the network connection report, and then follow the solutions.

Check Network Connection	
Check Result	FAIL
Error code	(E-2)
<p>See the Network Status and check if the Network Name (SSID) is the SSID you want to connect. If the SSID is correct, make sure to enter the correct password and try again.</p>	
<p>If your problems persist, see your documentation for help and networking tips.</p>	
Checked Items	
Wireless Network Name (SSID) Check	FAIL
Communication Mode Check	Unchecked
Security Mode Check	Unchecked
MAC Address Filtering Check	Unchecked
Security Key/Password Check	Unchecked
IP Address Check	Unchecked
Detailed IP Setup Check	Unchecked
Network Status	
Printer Name	EPSON XXXXXX
Printer Model	XX-XXX Series
IP Address	169.254.137.8
Subnet Mask	255.255.0.0
Default Gateway	
Network Name (SSID)	EpsonNet
Security	None
Signal Strength	Poor
MAC Address	F8:D0:27:40:C0:AC

- a. Error code  
b. Messages on the Network Environment

### Related Information

- ➔ [“E-1” on page 25](#)  
 ➔ [“E-2, E-3, E-7” on page 25](#)  
 ➔ [“E-5” on page 26](#)  
 ➔ [“E-6” on page 26](#)  
 ➔ [“E-8” on page 26](#)



## Network Settings

- ➔ “E-9” on page 27
- ➔ “E-10” on page 27
- ➔ “E-11” on page 27
- ➔ “E-12” on page 28
- ➔ “E-13” on page 28
- ➔ “Message on the Network Environment” on page 29

### E-1

#### Solutions:

- Make sure the Ethernet cable is securely connected to your printer and to your hub or other network device.
- Make sure your hub or other network device is turned on.
- If you want to connect the printer by Wi-Fi, make Wi-Fi settings for the printer again because it is disabled.

### E-2, E-3, E-7

#### Solutions:

- Make sure your wireless router is turned on.
- Confirm that your computer or device is connected correctly to the wireless router.
- Turn off the wireless router. Wait for about 10 seconds, and then turn it on.
- Place the printer closer to your wireless router and remove any obstacles between them.
- If you have entered the SSID manually, check if it is correct. Check the SSID from the **Network Status** part on the network connection report.
- If an wireless router has multiple SSIDs, select the SSID that is displayed. When the SSID is using a non-compliant frequency, the printer does not display them.
- If you are using push button setup to establish a network connection, make sure your wireless router supports WPS. You cannot use push button setup if your wireless router does not support WPS.
- Make sure your SSID uses only ASCII characters (alphanumeric characters and symbols). The printer cannot display an SSID that contains non-ASCII characters.
- Make sure you know your SSID and password before connecting to the wireless router. If you are using a wireless router with its default settings, the SSID and password are located on a label on the wireless router. If you do not know your SSID and password, contact the person who set up the wireless router, or see the documentation provided with the wireless router.
- If you are connecting to an SSID generated from a tethering smart device, check for the SSID and password in the documentation provided with the smart device.
- If your Wi-Fi connection suddenly disconnects, check for the conditions below. If any of these conditions are applicable, reset your network settings by downloading and running the software from the following website.  
<http://epson.sn> > **Setup**
  - Another smart device was added to the network using push button setup.
  - The Wi-Fi network was set up using any method other than push button setup.

## Network Settings

### Related Information

- ➔ [“Connecting to a Computer” on page 18](#)
- ➔ [“Making Wi-Fi Settings from the Printer” on page 19](#)

## E-5

### Solutions:

Make sure the wireless router's security type is set to one of the following. If it is not, change the security type on the wireless router, and then reset the printer's network settings.

- WEP-64 bit (40 bit)
- WEP-128 bit (104 bit)
- WPA PSK (TKIP/AES)\*
- WPA2 PSK (TKIP/AES)\*
- WPA (TKIP/AES)
- WPA2 (TKIP/AES)

\* WPA PSK is also known as WPA Personal. WPA2 PSK is also known as WPA2 Personal.

## E-6

### Solutions:

- Check if MAC address filtering is disabled. If it is enabled, register the printer's MAC address so that it is not filtered. See the documentation provided with the wireless router for details. You can check the printer's MAC address from the **Network Status** part on the network connection report.
- If your wireless router is using shared authentication with WEP security, make sure the authentication key and index are correct.
- If the number of connectable devices on the wireless router is less than the number of network devices that you want to connect, make settings on the wireless router to increase the number of connectable devices. See the documentation provided with the wireless router to make settings.

### Related Information

- ➔ [“Printing a Network Status Sheet” on page 29](#)

## E-8

### Solutions:

- Enable DHCP on the wireless router if the printer's Obtain IP Address setting is set to **Auto**.
- If the printer's Obtain IP Address setting is set to Manual, the IP address you manually set is invalid due to out of range (for example: 0.0.0.0). Set a valid IP address from the printer's control panel or by using Web Config.

## Network Settings

### Related Information

➔ [“Printing a Network Status Sheet” on page 29](#)

## E-9

### Solutions:

Check the following.

- Devices are turned on.
- You can access the Internet and other computers or network devices on the same network from the devices you want to connect to the printer.

If still does not connect your printer and network devices after confirming the above, turn off the wireless router. Wait for about 10 seconds, and then turn it on. Then reset your network settings by downloading and running the installer from the following website.

<http://epson.sn> > Setup

### Related Information

➔ [“Connecting to a Computer” on page 18](#)

## E-10

### Solutions:

Check the following.

- Other devices on the network are turned on.
- Network addresses (IP address, subnet mask, and default gateway) are correct if you have set the printer's Obtain IP Address to Manual.

Reset the network address if they are incorrect. You can check the IP address, subnet mask, and default gateway from the **Network Status** part on the network connection report.

If DHCP is enabled, change the printer's Obtain IP Address setting to **Auto**. If you want to set the IP address manually, check the printer's IP address from the **Network Status** part on the network connection report, and then select Manual on the network settings screen. Set the subnet mask to [255.255.255.0].

If still does not connect your printer and network devices, turn off the wireless router. Wait for about 10 seconds, and then turn it on.

### Related Information

➔ [“Printing a Network Status Sheet” on page 29](#)

## E-11

### Solutions:

Check the following.

## Network Settings

- The default gateway address is correct if you set the printer's TCP/IP Setup setting to Manual.
- The device that is set as the default gateway is turned on.

Set the correct default gateway address. You can check the default gateway address from the **Network Status** part on the network connection report.

### Related Information

- ➔ [“Printing a Network Status Sheet” on page 29](#)

## E-12

### Solutions:

Check the following.

- Other devices on the network are turned on.
- The network addresses (IP address, subnet mask, and default gateway) are correct if you are entering them manually.
- The network addresses for other devices (subnet mask and default gateway) are the same.
- The IP address does not conflict with other devices.

If still does not connect your printer and network devices after confirming the above, try the following.

- Turn off the wireless router. Wait for about 10 seconds, and then turn it on.
- Make network settings again using the installer. You can run it from the following website.  
<http://epson.sn> > **Setup**
- You can register several passwords on a wireless router that uses WEP security type. If several passwords are registered, check if the first registered password is set on the printer.

### Related Information

- ➔ [“Printing a Network Status Sheet” on page 29](#)
- ➔ [“Connecting to a Computer” on page 18](#)

## E-13

### Solutions:

Check the following.

- Network devices such as a wireless router, hub, and router are turned on.
- The TCP/IP Setup for network devices has not been set up manually. (If the printer's TCP/IP Setup is set automatically while the TCP/IP Setup for other network devices is performed manually, the printer's network may differ from the network for other devices.)

If it still does not work after checking the above, try the following.

- Turn off the wireless router. Wait for about 10 seconds, and then turn it on.

## Network Settings

- ❑ Make network settings on the computer that is on the same network as the printer using the installer. You can run it from the following website.

<http://epson.sn> > Setup

- ❑ You can register several passwords on a wireless router that uses the WEP security type. If several passwords are registered, check if the first registered password is set on the printer.

### Related Information

- ➔ “Printing a Network Status Sheet” on page 29
- ➔ “Connecting to a Computer” on page 18

## Message on the Network Environment

Message	Solution
The Wi-Fi environment needs to be improved. Turn the wireless router off and then turn it on. If the connection does not improve, see the documentation for the wireless router.	After moving the printer closer to the wireless router and removing any obstacles between them, turn off the wireless router. Wait for about 10 seconds, and then turn it on. If it still does not connect, see the documentation supplied with the wireless router.
*No more devices can be connected. Disconnect one of the connected devices if you want to add another one.	Computer and smart devices that can be connected simultaneously are connected in full in the Wi-Fi Direct (Simple AP) connection. To add another computer or smart device, disconnect one of the connected devices or connect it to the other network first.  You can confirm the number of wireless devices which can be connected simultaneously and the number of connected devices by checking the network status sheet.

## Printing a Network Status Sheet

You can check the detailed network information by printing it such as the maximum number of devices you can connect by Wi-Fi Direct (simple AP).

1. Load papers.
2. Hold down the  button on the printer's control panel for at least 5 seconds.

The network status sheet is printed.

**Note:**

If you release the  button within 5 seconds, a network connection report is printed.

## Replacing or Adding New Wireless Routers

If the SSID changes due to the replacement of a wireless router, or a wireless router is added and a new network environment is established, re-set the Wi-Fi settings.

**Related Information**

➔ “Changing the Connection Method to a Computer” on page 30

---

## Changing the Connection Method to a Computer

Using the installer and re-set up in a different connection method.

- Setting up from the website

Access the following website, and then enter the product name. Go to **Setup**, and then start setting up.

<http://epson.sn>

- Setting up using the software disc (only for the models that come with a software disc and users with Windows computers with disc drives.)

Insert the software disc into the computer, and then follow the on-screen instructions.

**Selecting Change the Connection Methods**

Follow the on-screen instructions until the following screen is displayed.



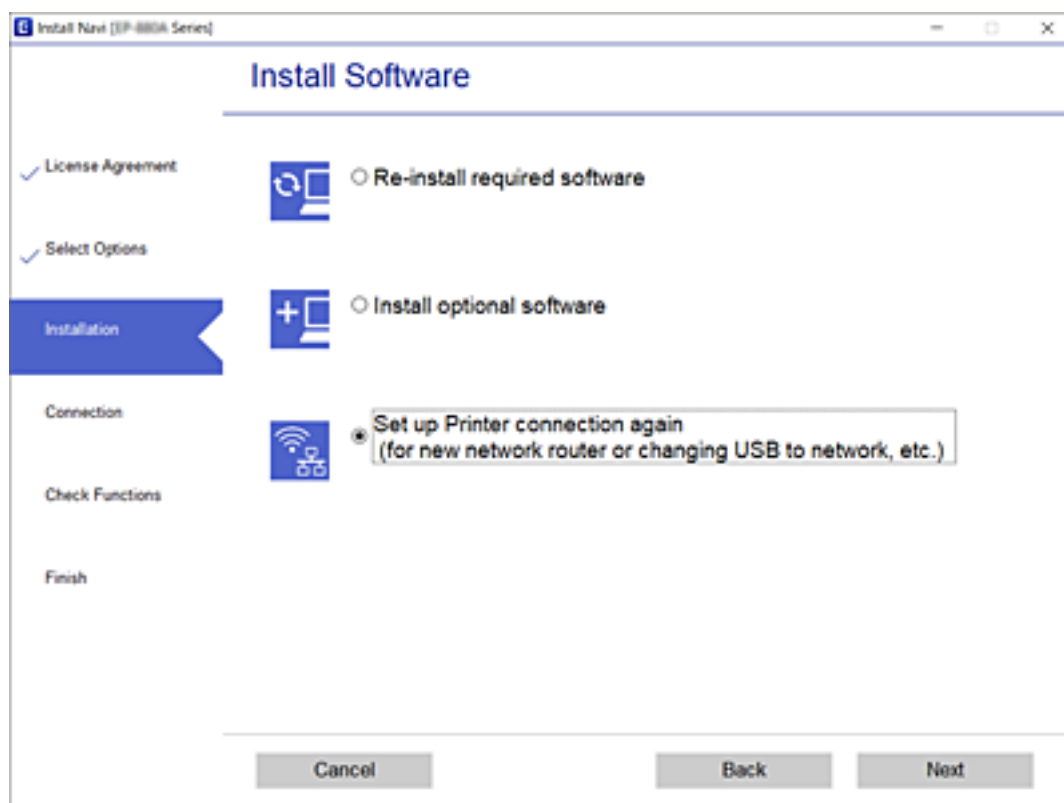

Select **Set up Printer connection again (for new network router or changing USB to network, etc.)** on the Install Software screen, and then click **Next**.



---

## Restoring the Network Settings from the Control Panel

You can restore all network settings to their defaults.

1. Turn the printer off.
2. While holding down the  button, press the  button until the  light and the  light flash alternately.

Restoration is complete when the  light and the  light are off.

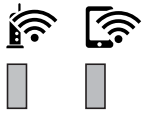

# Preparing the Printer

## Loading Papers

### Available Paper and Capacities

**Note:**

The paper size displayed differs depending on the driver.

### Genuine Epson Paper

Epson recommends using genuine Epson paper to ensure high-quality printouts.

**Note:**

- The availability of paper varies by location. For the latest information on paper available in your area, contact Epson support.
- When printing on genuine Epson paper at a user defined size, only **Standard** or **Normal** print quality settings are available. Although some printer drivers allow you to select a better print quality, the printouts are printed using **Standard** or **Normal**.

#### Paper suitable for printing documents

Media Name	Size	Loading Capacity (Sheets)		2-Sided Printing
		Paper Cassette	Rear Paper Feed Slot	
Epson Bright White Ink Jet Paper	A4	200	1	✓

#### Paper suitable for printing documents and photos

Media Name	Size	Loading Capacity (Sheets)		2-Sided Printing
		Paper Cassette	Rear Paper Feed Slot	
Epson Photo Quality Ink Jet Paper	A4	100	1	–
Epson Matte Paper-Heavyweight	A4	20	1	–
Epson Double-Sided Matte Paper	A4	1	1	–



## Preparing the Printer

### Related Information

➔ [“Part Names and Functions” on page 11](#)

## Commercially Available Paper

### Plain papers

Media Name	Size	Loading Capacity (Sheets)		2-Sided Printing
		Paper Cassette	Rear Paper Feed Slot	
Plain paper	Letter, A4	250	1	✓
Copy paper	B5, 16K (195×270 mm)	250	1	✓
Letterhead* <sup>1</sup>	A5, A6, B6	250	1	-
High quality plain paper	Legal, Indian-Legal, 8.5×13 in.	1	1	-
	User Defined (mm) 89×127 to 215.9×1200	1	1	-
	User Defined (mm) 54×86 to 215.9×1200	-	1	-
	User Defined (mm) 182×257 to 215.9×297	1	1	✓

\*1 Paper on which information such as the sender's name or corporation name are pre-printed in the header. There must be a margin of 3 mm or more at the top of the paper. 2-sided printing is not available for letterhead paper.

### Thick papers

Media Name	Size	Loading Capacity (Sheets)		2-Sided Printing
		Paper Cassette	Rear Paper Feed Slot	
Thick paper (91 to 256 g/m <sup>2</sup> )	Letter, A4, B5, A5, A6, Legal	-	1	-
	User Defined (mm) 89×127 to 215.9×1200	-	1	-

### Envelopes

Media Name	Size	Loading Capacity (Envelopes)		2-Sided Printing
		Paper Cassette	Rear Paper Feed Slot	
Envelope	Envelope #10, Envelope DL, Envelope C6	10	1	-

## Preparing the Printer

### Related Information

➔ [“Part Names and Functions” on page 11](#)

### Paper Handling Precautions

- ❑ Read the instruction sheets supplied with the paper.
- ❑ To achieve high-quality printouts with genuine Epson paper, use the paper in the environment stated on the sheets supplied with the paper.
- ❑ Fan and align the edges of the paper before loading. Do not fan or curl photo paper. Doing so may damage the printable side.

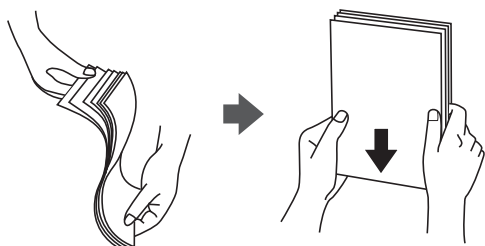

- ❑ If the paper is curled, flatten it or curl it slightly in the opposite direction before loading. Printing on curled paper may cause paper jams and smears on the printout.

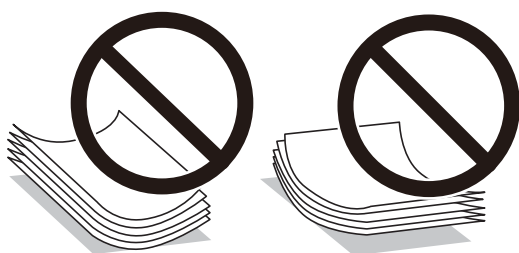

- ❑ Do not use paper that is wavy, torn, cut, folded, damp, too thick, too thin, or paper that has stickers stuck to it. Using these types of paper causes paper jams and smears on the printout.
- ❑ Make sure you are using long-grain paper. If you are not sure what type of paper you are using, check the paper packaging or contact the manufacturer to confirm the paper specifications.

### Related Information

➔ [“Printer Specifications” on page 124](#)

## Loading Paper in the Paper Cassette

1. Open the paper cassette cover until it clicks.

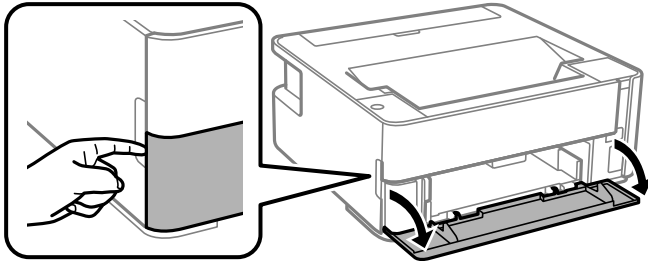

2. Check that the printer is not operating, and then slide out the paper cassette.

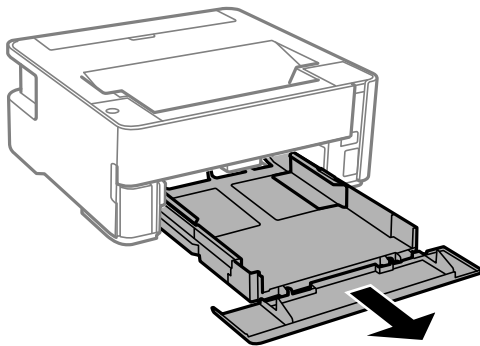

**Important:**

*The paper cassette cannot be removed.*

3. Slide the edge guides to their maximum position.

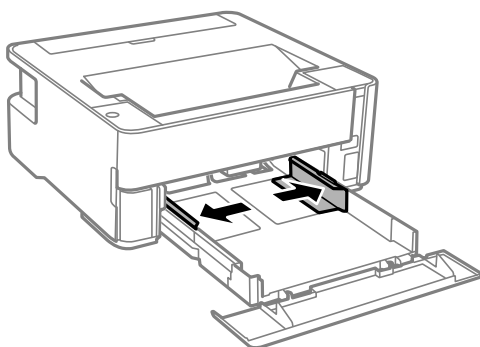

### Preparing the Printer

4. With the printable side facing down, load paper until it touches the back of the paper cassette.

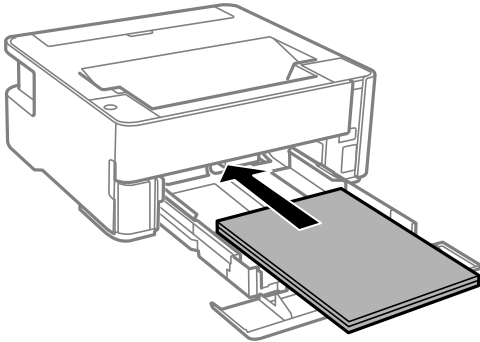

**!** **Important:**

*Do not load more than the maximum number of sheets specified for the paper.*

- 8.5 x 13 in.

Load paper using the line.

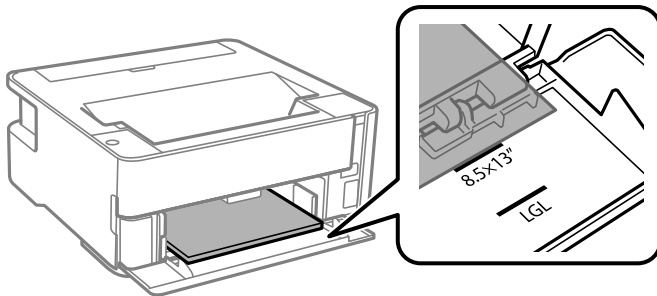

- Legal

Load paper using the line.

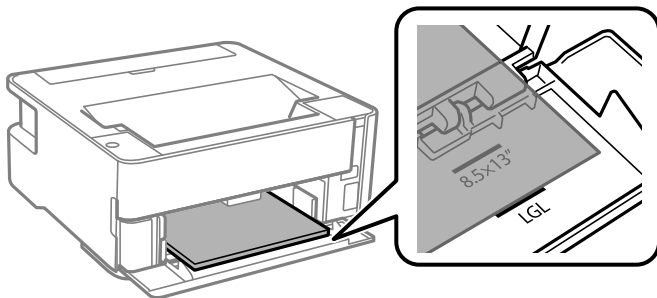

## Preparing the Printer

- Slide the edge guides to the edges of the paper.

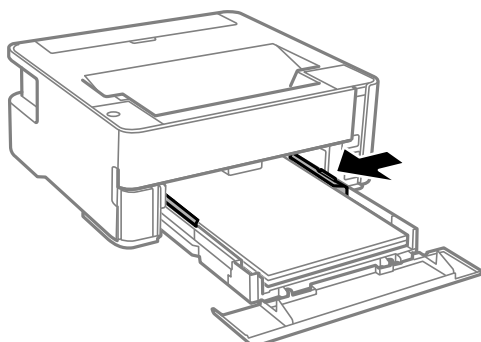

- Insert the paper cassette gently.
- Close the paper cassette cover when loading paper shorter than A4 size.
- When you load business card size paper, lower the output switch lever to output the paper to the front of the printer.

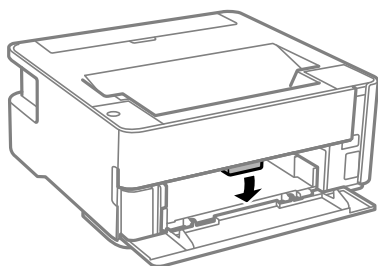

**Note:**

- We also recommend outputting envelopes to the front of the printer.
- For letterhead paper, select **Letterhead** as the paper type.
- For letterhead paper, if you print on paper that is smaller than the setting in the printer driver, the printer may print beyond the edges of the paper which can lead to ink smears on your printouts and excess ink building up inside the printer. Make sure you select the correct paper size setting.
- 2-sided printing is not available for letterhead paper. Also, the print speed may be slower.

### Related Information

- ➔ [“Paper Handling Precautions” on page 34](#)
- ➔ [“Available Paper and Capacities” on page 32](#)
- ➔ [“List of Paper Type” on page 40](#)
- ➔ [“Loading Envelopes and Precautions” on page 40](#)

## Loading Paper in the Rear Paper Feed Slot

1. Open the feeder guard.

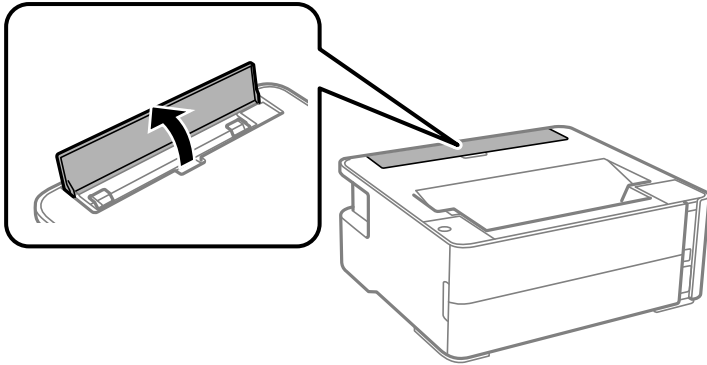

2. Slide out the edge guides.

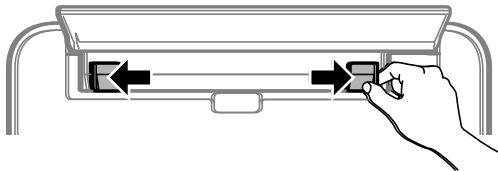

3. Load a single sheet of paper at the center of the rear paper feed slot with the printable side facing up.

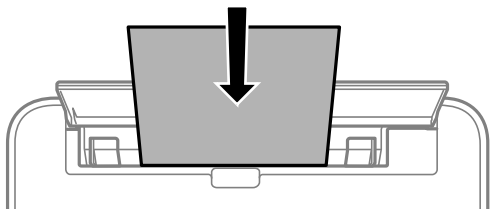

- ❑ Envelopes

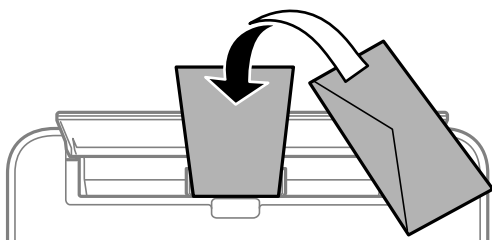

- ❑ Pre-punched paper

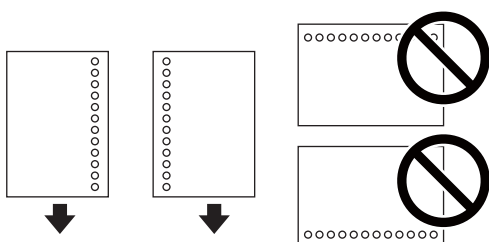

## Preparing the Printer

**Note:**

- Load a single sheet of paper without binding holes at the top and bottom.
- Adjust the print position of your file to avoid printing over the holes.

4. Slide the edge guides to the edges of the paper.

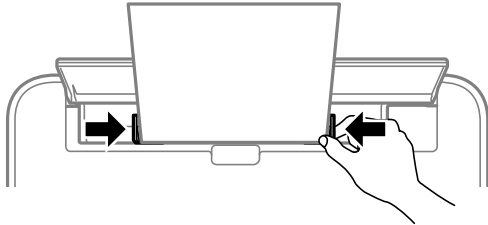

5. When you load thick paper or business card size paper, lower the output switch lever to output the paper to the front of the printer.

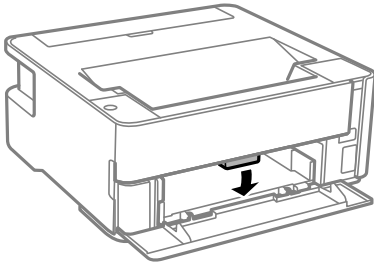

**Note:**

We also recommend outputting envelopes to the front of the printer.

**Note:**

- For letterhead paper, select **Letterhead** as the paper type.
- For letterhead paper, if you print on paper that is smaller than the setting in the printer driver, the printer may print beyond the edges of the paper which can lead to ink smears on your printouts and excess ink building up inside the printer. Make sure you select the correct paper size setting.
- 2-sided printing is not available for letterhead paper. Also, the print speed may be slower.

### Related Information

- ➔ [“Paper Handling Precautions” on page 34](#)
- ➔ [“Available Paper and Capacities” on page 32](#)
- ➔ [“Loading Envelopes and Precautions” on page 40](#)

## Preparing the Printer

### Loading Envelopes and Precautions

Load envelopes in the center of the rear paper feed slot short edge first with the flap facing down, and slide the edge guides to the edges of the envelopes.

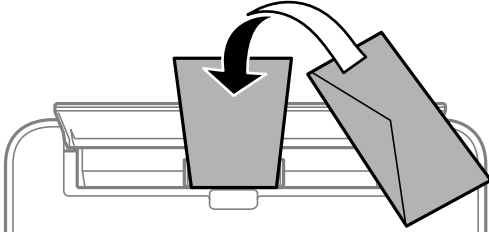

Load envelopes in the paper cassette with the flap facing up, and then slide the edge guides to the edges of the envelopes.

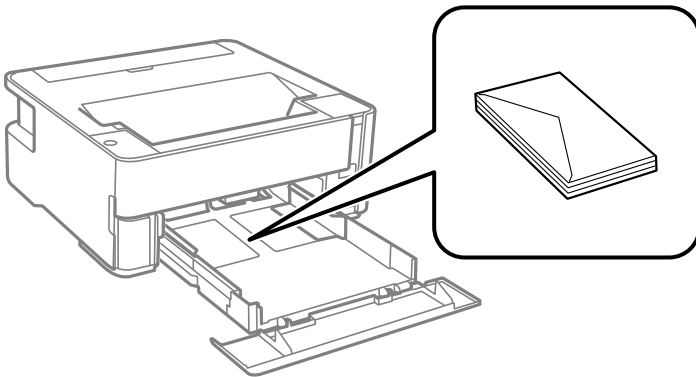

- ❑ Fan and align the edges of the envelopes before loading. When the stacked envelopes are puffed up with air, press them down to flatten them before loading.

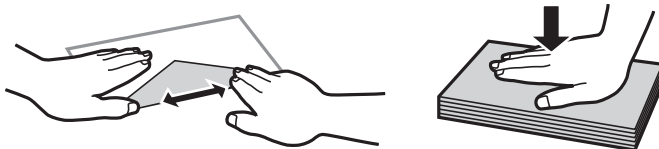

- ❑ Do not use envelopes that are curled or folded. Using these envelopes causes paper jams and smears on the printout.
- ❑ Do not use envelopes with adhesive surfaces on the flaps or window envelopes.
- ❑ Avoid using envelopes that are too thin, as they may curl during printing.

#### Related Information

- ➔ [“Available Paper and Capacities” on page 32](#)
- ➔ [“Loading Paper in the Paper Cassette” on page 35](#)

### List of Paper Type

To obtain optimum printing results, select the paper type that suits the paper.



## Preparing the Printer

Media Name	Media Type
Epson Bright White Ink Jet Paper	Plain paper
Epson Matte Paper-Heavyweight Epson Double-Sided Matte Paper	Epson Matte
Epson Photo Quality Ink Jet Paper	Epson Photo Quality Ink Jet

## Outputting Paper

- ❑ Printed paper is ejected to the output tray with the printed side facing down. For A4 size plain paper (with a thickness of 80g/m<sup>2</sup>), up to 100 sheets can be ejected at a time. Outputting more than 100 sheets may cause paper to fall or a paper jam to occur. Remove any excess paper so that it does not exceed the maximum number of sheets that can be ejected.
- ❑ When you load thick paper or business card size paper, lower the output switch lever to output paper to the front of the printer. We also recommend outputting envelopes to the front of the printer.

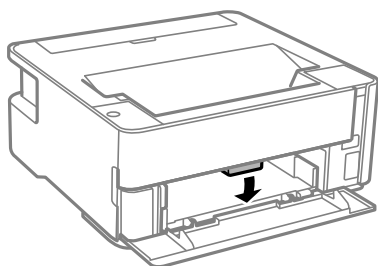

## Saving Power

The printer enters sleep mode or turns off automatically if no operations are performed for a set period. You can adjust the time before power management is applied. Any increase will affect the product's energy efficiency. Please consider the environment before making any change.

Depending on the location of purchase, the printer may have a feature that turns it off automatically if it is not connected to the network for 30 minutes.

### Saving Power - Windows

1. Access the printer driver window.
2. Click **Printer and Option Information** on the **Maintenance** tab.
3. Do one of the following.

**Note:**

*Your product may have the **Power Off Timer** feature or **Power Off If Disconnected** and **Power Off If Disconnected** features depending on the location of purchase.*

## Preparing the Printer

- Select the time period before the printer enters sleep mode as the **Sleep Timer** setting, and click **Send**. To make the printer turn off automatically, select the time period as the **Power Off Timer** setting, and click **Send**.
  - Select the time period before the printer enters sleep mode as the **Sleep Timer** setting, and click **Send**. To make the printer turn off automatically, select the time period in the **Power Off If Inactive** or **Power Off If Disconnected** setting, and then click **Send**.
4. Click **OK**.

## Saving Power - Mac OS

1. Select **System Preferences** from the  menu > **Printers & Scanners** (or **Print & Scan**, **Print & Fax**), and then select the printer.
2. Click **Options & Supplies** > **Utility** > **Open Printer Utility**.
3. Click **Printer Settings**.
4. Do one of the following.

**Note:**

*Your product may have the **Power Off Timer** feature or **Power Off If Inactive** and **Power Off If Disconnected** features depending on the location of purchase.*

- Select the time period before the printer enters sleep mode as the **Sleep Timer** setting, and click **Apply**. To make the printer turn off automatically, select the time period as the **Power Off Timer** setting, and click **Apply**.
- Select the time period before the printer enters sleep mode as the **Sleep Timer** setting, and click **Apply**. To make the printer turn off automatically, select the time period in the **Power Off If Inactive** or **Power Off If Disconnected** setting, and then click **Apply**.

# Printing

---

## Printing from the Printer Driver on Windows

### Accessing the Printer Driver

When accessing the printer driver from the computer's control panel, the settings are applied to all of the applications.

#### Accessing the printer driver from the control panel

Windows 10/Windows Server 2016

Click on the start button, and then select **Windows System > Control Panel > View devices and printers in Hardware and Sound**. Right-click on your printer, or press and hold it and then select **Printing preferences**.

Windows 8.1/Windows 8/Windows Server 2012 R2/Windows Server 2012

Select **Desktop > Settings > Control Panel > View devices and printers in Hardware and Sound**. Right-click on your printer, or press and hold it and then select **Printing preferences**.

Windows 7/Windows Server 2008 R2

Click the start button, and select **Control Panel > View devices and printers in Hardware and Sound**. Right-click on your printer and select **Printing preferences**.

Windows Vista/Windows Server 2008

Click the start button, and select **Control Panel > Printers in Hardware and Sound**. Right-click on your printer and select **Printing preferences**.

Windows XP/Windows Server 2003 R2/Windows Server 2003

Click the start button, and select **Control Panel > Printers and Other Hardware > Printers and Faxes**. Right-click on your printer and select **Printing preferences**.

#### Accessing the printer driver from the printer icon on the task bar

The printer icon on the desktop task bar is a shortcut icon allowing you to quickly access the printer driver.

If you click the printer icon and select **Printer Settings**, you can access the same printer settings window as the one displayed from the control panel. If you double-click this icon, you can check the status of the printer.

**Note:**

*If the printer icon is not displayed on the task bar, access the printer driver window, click **Monitoring Preferences** on the **Maintenance** tab, and then select **Register the shortcut icon to the taskbar**.*

### Printing Basics

**Note:**

*Operations may differ depending on the application. See the application's help for details.*

1. Open the file you want to print.  
Load paper in the printer if it has not already been loaded.

## Printing

2. Select **Print** or **Page Setup** from the **File** menu.
3. Select your printer.
4. Select **Preferences** or **Properties** to access the printer driver window.

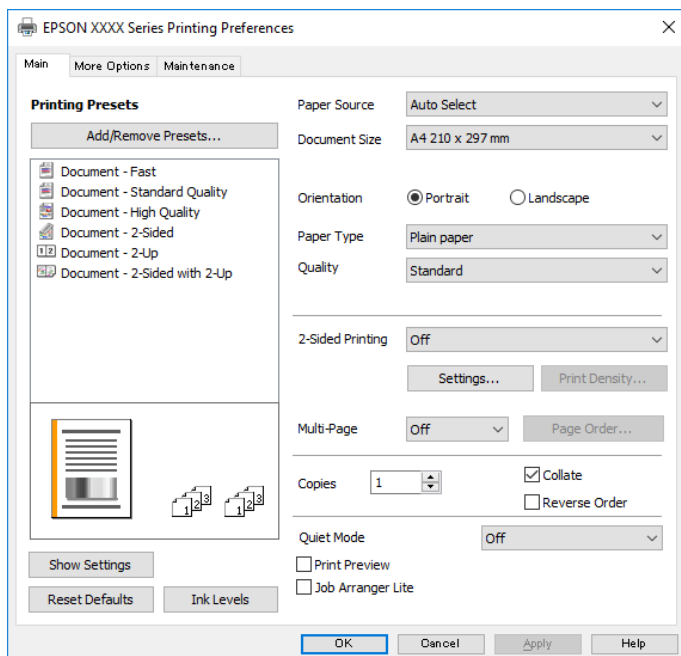

5. Change the settings as necessary.  
See the menu options for the printer driver for details.

**Note:**

- You can also see the online help for explanations of the setting items. Right-clicking an item displays **Help**.
- When you select **Print Preview**, you can see a preview of your document before printing.

6. Click **OK** to close the printer driver window.
7. Click **Print**.

**Note:**

When you select **Print Preview**, a preview window is displayed. To change the settings, click **Cancel**, and then repeat the procedure from step 2.

### Related Information

- ➔ [“Available Paper and Capacities” on page 32](#)
- ➔ [“Loading Paper in the Paper Cassette” on page 35](#)
- ➔ [“List of Paper Type” on page 40](#)
- ➔ [“Main Tab” on page 58](#)

## Printing

### Printing on 2-Sides

You can print on both sides of the paper. You can also print a booklet that can be created by re-ordering the pages and folding the printout.

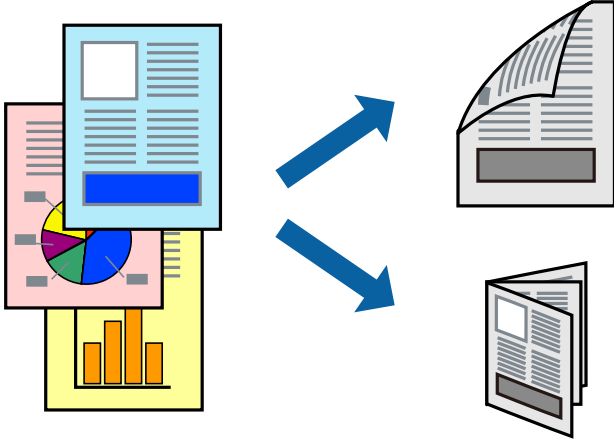

**Note:**

- If you do not use paper that is suitable for 2-sided printing, the print quality may decline and paper jams may occur.
- Depending on the paper and the data, ink may bleed through to the other side of the paper.

**Related Information**

- ➔ [“Available Paper and Capacities” on page 32](#)

### Print Settings

1. On the printer driver's **Main** tab, select an option from **2-Sided Printing**.
2. Click **Settings**, make the appropriate settings, and then click **OK**.

Make settings for **Print Density** if necessary.

**Note:**

- To print a folded booklet, select **Booklet**.
- When setting **Print Density**, you can adjust print density according to the document type.
- Printing may be slow depending on the combination of options selected for **Select Document Type** in the **Print Density Adjustment** window and for **Quality** on the **Main** tab.

3. Click **Print**.

**Related Information**

- ➔ [“Printing Basics” on page 43](#)
- ➔ [“Main Tab” on page 58](#)

## Printing

### Printing Several Pages on One Sheet

You can print two or four pages of data on a single sheet of paper.

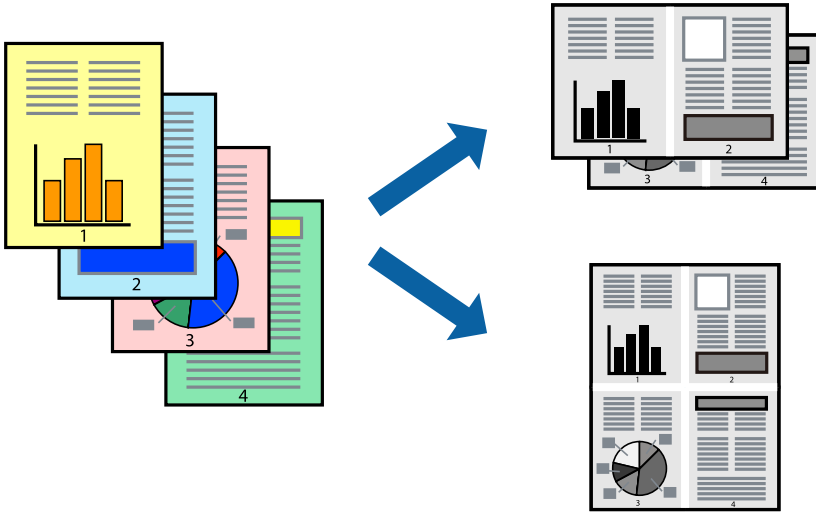

### Print Settings

On the printer driver's **Main** tab, select **2-Up** or **4-Up** as the **Multi-Page** setting.

#### Related Information

- ➔ [“Printing Basics” on page 43](#)
- ➔ [“Main Tab” on page 58](#)

### Printing and Stacking in Page Order (Reverse Order Printing)

You can print from the last page so that documents are stacked in page order for outputting paper to the front of the printer.

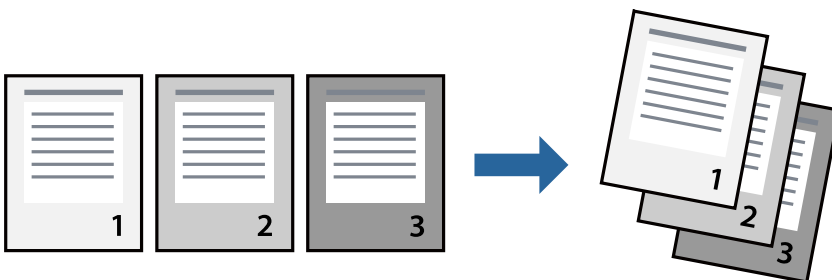

### Print Settings

On the printer driver's **Main** tab, select **Reverse Order**.

#### Related Information

- ➔ [“Printing Basics” on page 43](#)

## Printing

➔ [“Main Tab” on page 58](#)

### Printing a Reduced or Enlarged Document

You can reduce or enlarge the size of a document by a specific percentage or to fit the paper size you loaded in the printer.



### Print Settings

On the printer driver's **More Options** tab, select the document size from the **Document Size** setting. Select the paper size you want to print on from the **Output Paper** setting. Select **Reduce/Enlarge Document**, and then select **Fit to Page** or **Zoom to**. When you select **Zoom to**, enter a percentage.

Select **Center** to print the images in the center of the page.

### Related Information

- ➔ [“Printing Basics” on page 43](#)
- ➔ [“More Options Tab” on page 58](#)

### Printing One Image on Multiple Sheets for Enlargement (Creating a Poster)

This feature allows you to print one image on multiple sheets of paper. You can create a larger poster by taping them together.

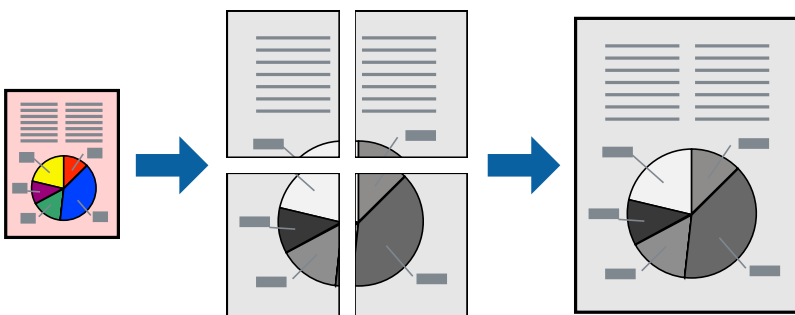

## Print Settings

On the printer driver's **Main** tab, select **2x1 Poster**, **2x2 Poster**, **3x3 Poster**, or **4x4 Poster** as the **Multi-Page** setting. If you click **Settings**, you can select the panels that you do not want to print. You can also select the cutting guide options.

### Related Information

- ➔ [“Printing Basics” on page 43](#)
- ➔ [“Main Tab” on page 58](#)

## Making Posters Using Overlapping Alignment Marks

Here is an example of how to make a poster when **2x2 Poster** is selected, and **Overlapping Alignment Marks** is selected in **Print Cutting Guides**.

The actual guides are printed in monochrome, but for this explanation they are shown as blue and red lines.

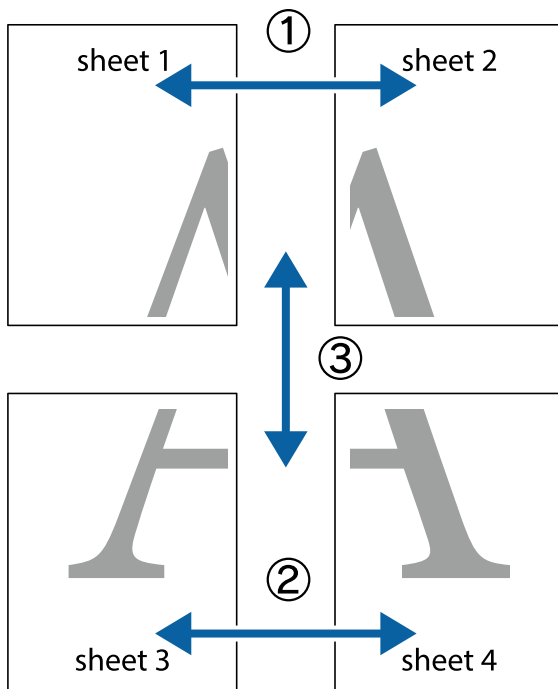



### Printing

1. Prepare Sheet 1 and Sheet 2. Cut off the margins of Sheet 1 along the vertical blue line through the center of the top and bottom cross marks.

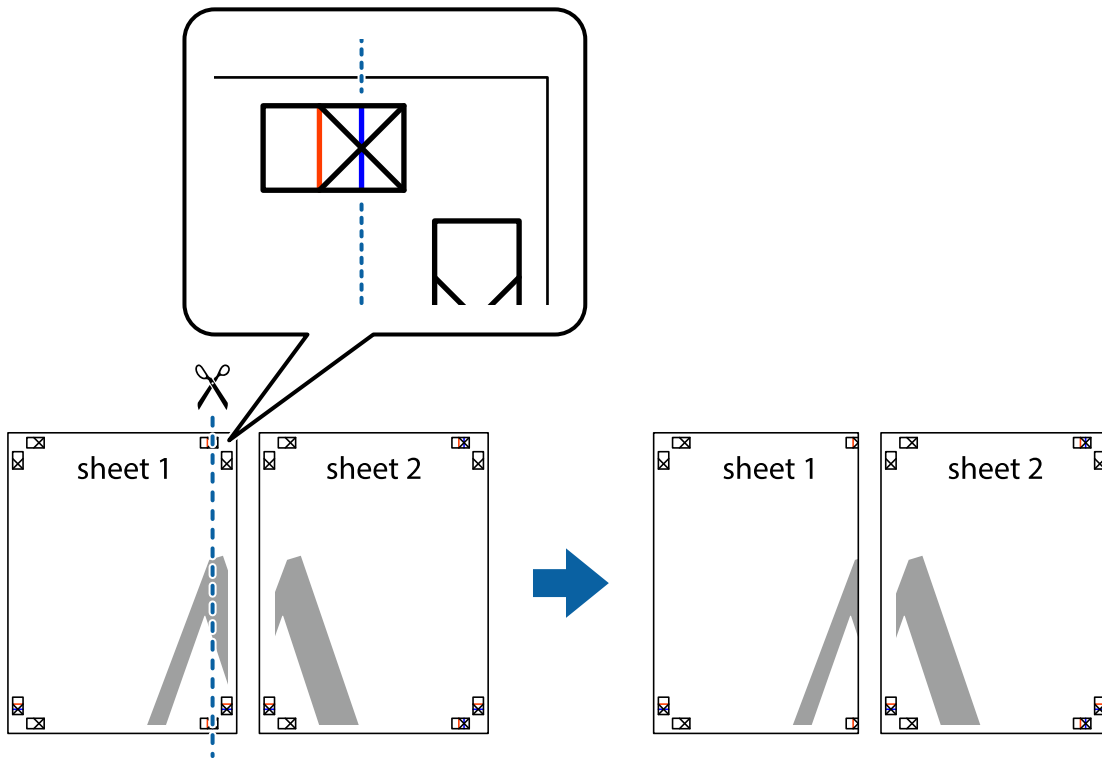

2. Place the edge of Sheet 1 on top of Sheet 2 and align the cross marks, then temporarily tape the two sheets together from the back.

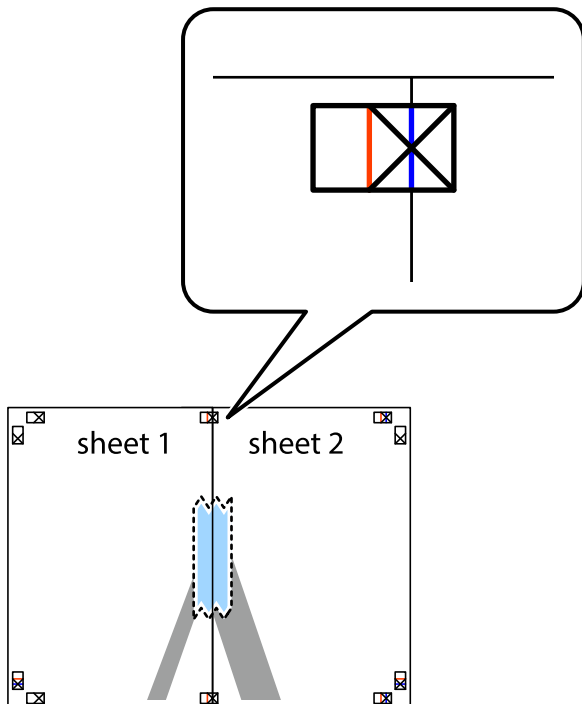

**Printing**

- Cut the taped sheets in two along the vertical red line through the alignment markers (this time, the line to the left of the cross marks).

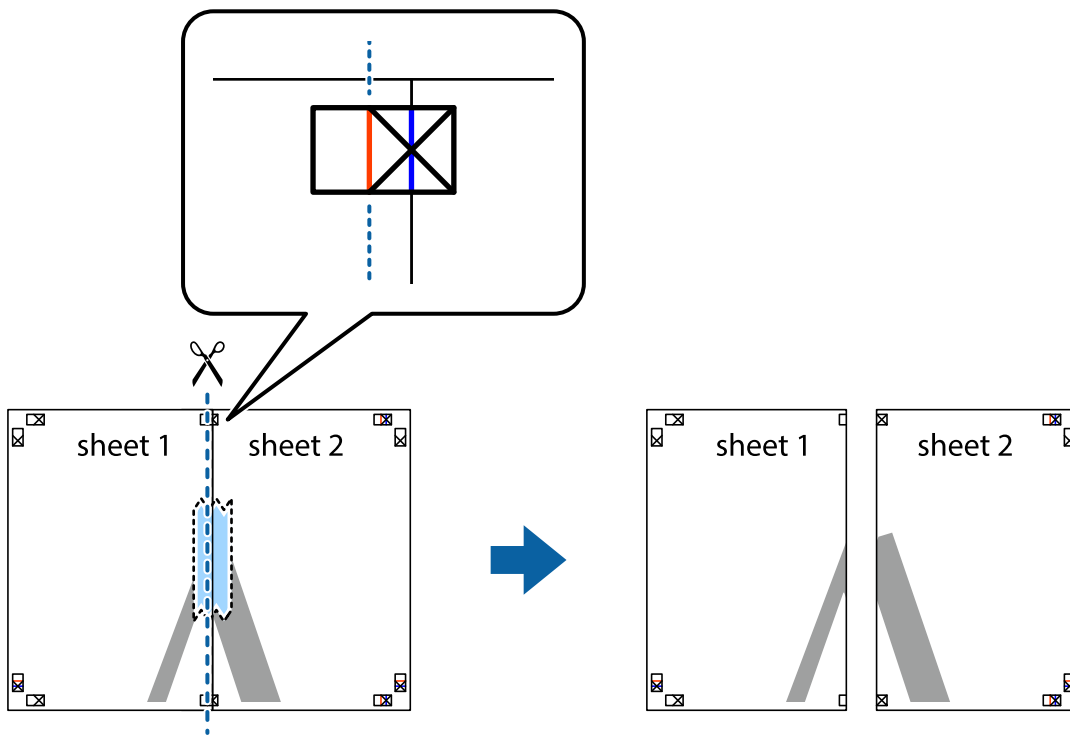

- Tape the sheets together from the back.

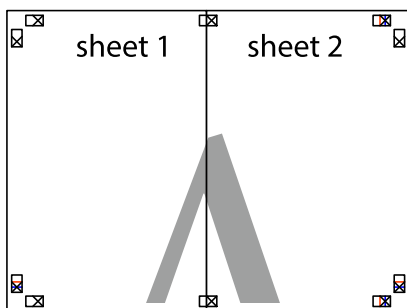

- Repeat steps 1 to 4 to tape Sheet 3 and Sheet 4 together.

### Printing

6. Cut off the margins of Sheet 1 and Sheet 2 along the horizontal blue line through the center of the left and right side cross marks.

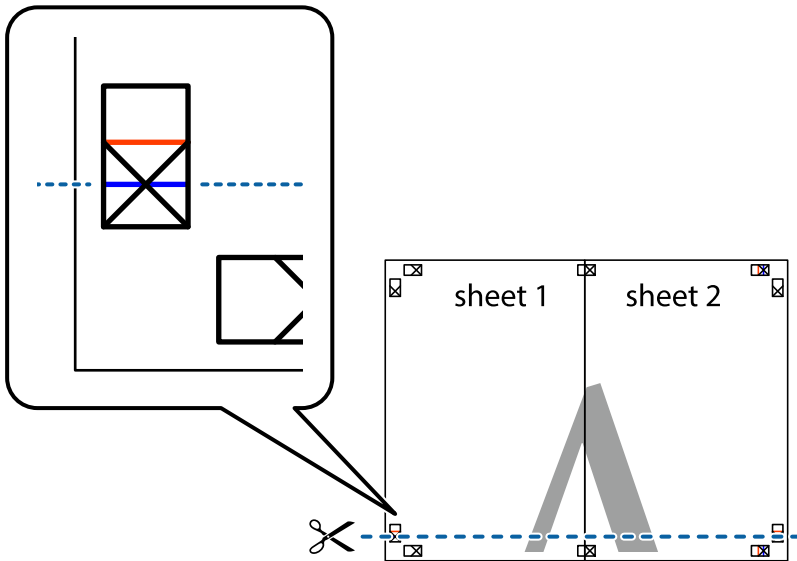

7. Place the edge of Sheet 1 and Sheet 2 on top of Sheet 3 and Sheet 4 and align the cross marks, and then temporarily tape them together from the back.

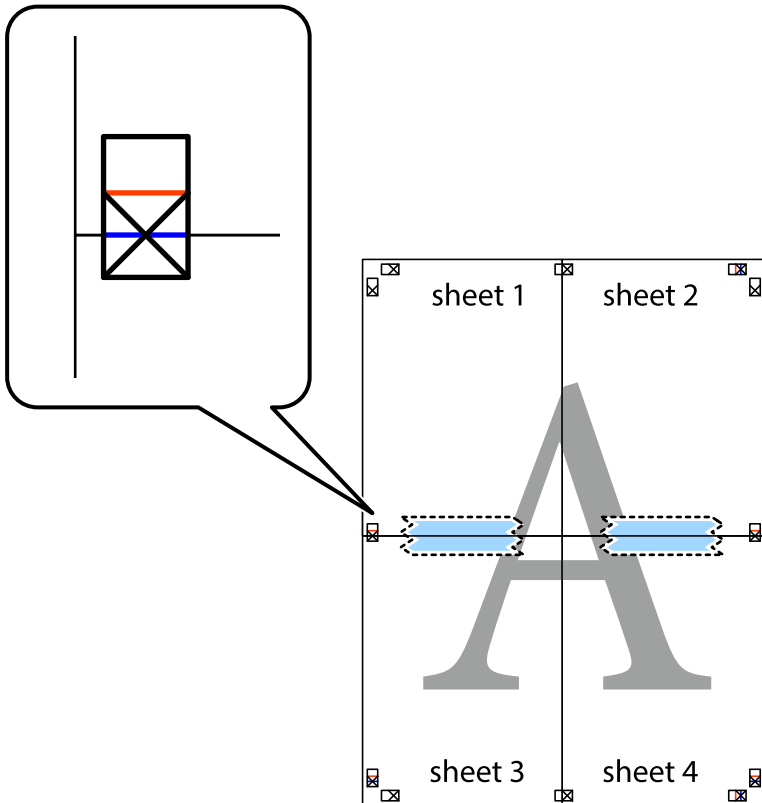

### Printing

- Cut the taped sheets in two along the horizontal red line through the alignment markers (this time, the line above the cross marks).

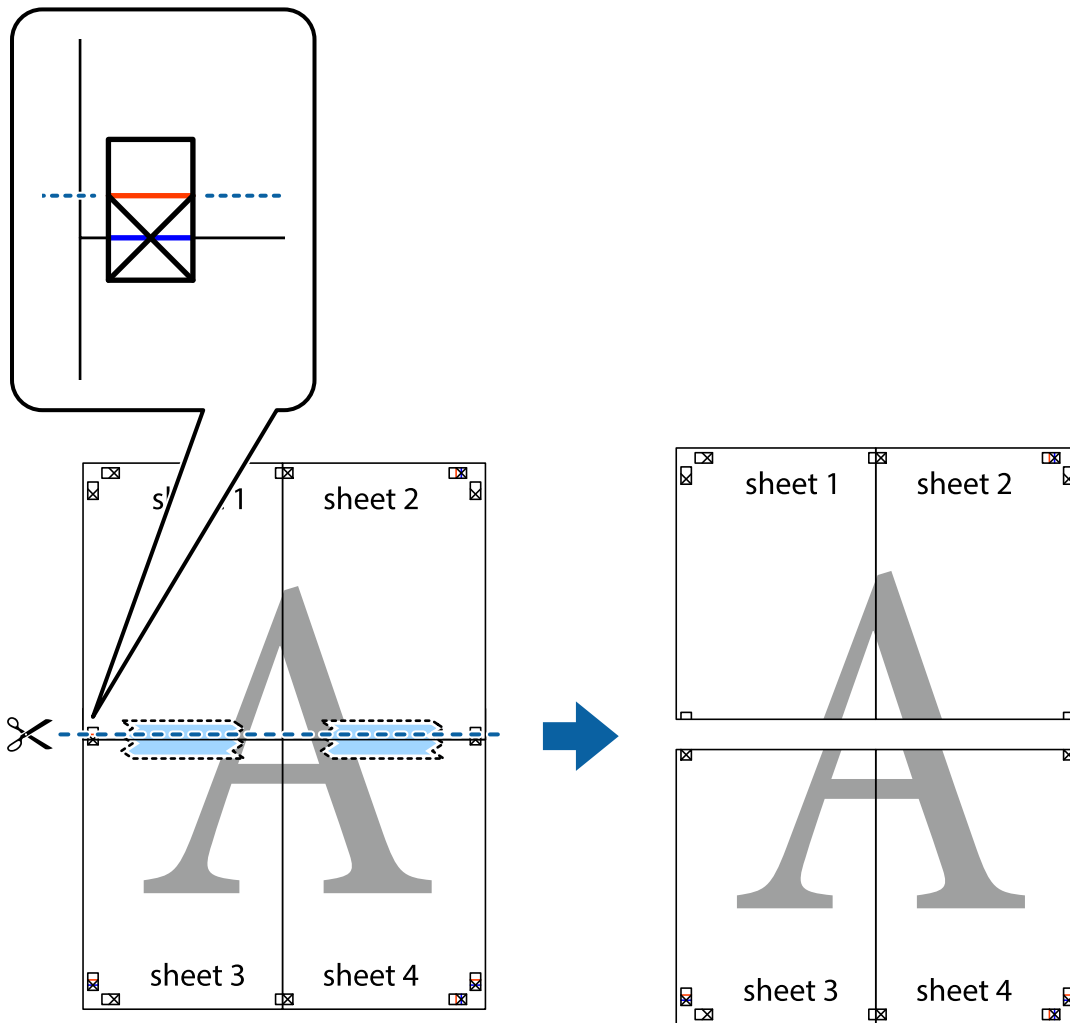

- Tape the sheets together from the back.

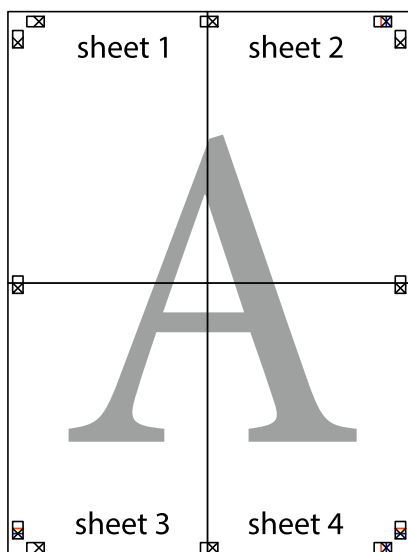

## Printing

10. Cut off the remaining margins along the outer guide.

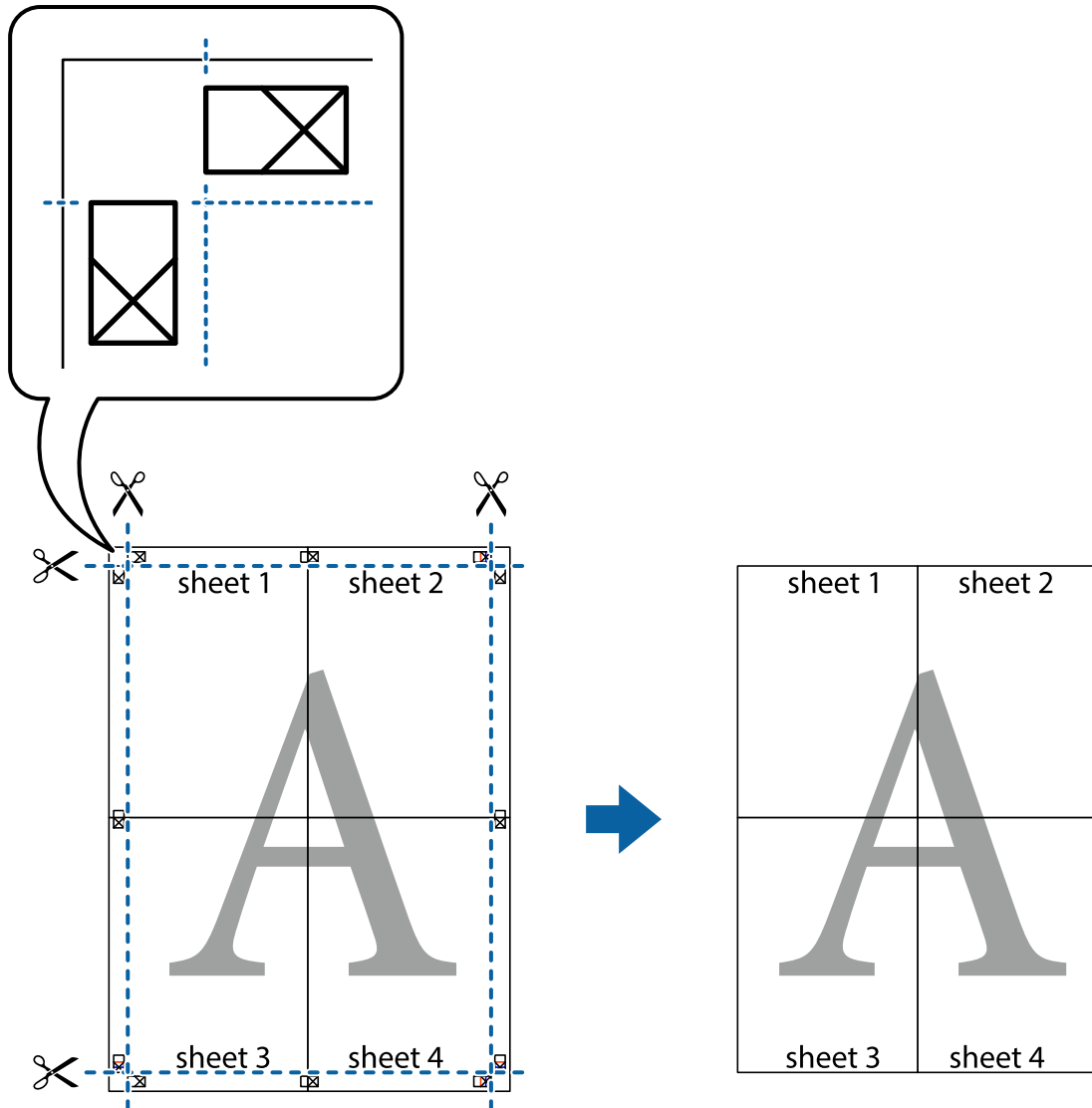

## Printing with a Header and Footer

You can print information such as a user name and printing date in headers or footers.

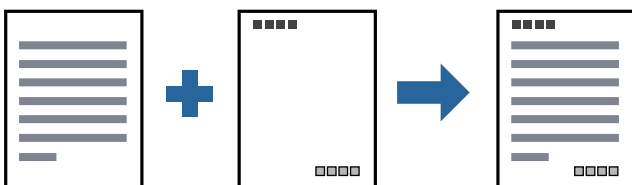

## Print Settings

On the printer driver's **More Options** tab, click **Watermark Features**, and then select **Header/Footer**. Click **Settings**, and then select the items you want to print.

## Printing

### Related Information

- ➔ [“Printing Basics” on page 43](#)
- ➔ [“More Options Tab” on page 58](#)

## Printing a Watermark

You can print a watermark such as "Confidential" or an anti-copy pattern on your printouts. If you print with an anti-copy pattern, the hidden letters appear when photocopied in order to distinguish the original from the copies.



Anti-Copy Pattern is available under the following conditions:

- Paper: Plain paper, Copy paper, Letterhead, or High quality plain paper
- Quality: Standard
- Automatic 2-sided printing: Not selected
- Tone Correction: Automatic

**Note:**

You can also add your own watermark or anti-copy pattern.

## Print Settings

On the printer driver's **More Options** tab, click **Watermark Features**, and then select Anti-Copy Pattern or Watermark. Click **Settings** to change details such as the size, density, or position of the pattern or the mark.

### Related Information

- ➔ [“Printing Basics” on page 43](#)
- ➔ [“More Options Tab” on page 58](#)

## Printing Multiple Files Together

Job Arranger Lite allows you to combine several files created by different applications and print them as a single print job. You can specify the print settings for combined files, such as multi-page layout, and 2-sided printing.

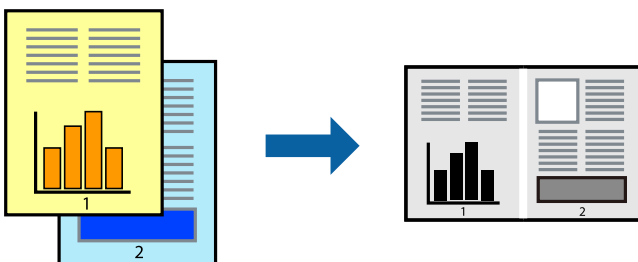

## Printing

### Print Settings

On the printer driver's **Main** tab, select **Job Arranger Lite**. When you start printing, the Job Arranger Lite window is displayed. With the Job Arranger Lite window opened, open the file that you want to combine with the current file, and then repeat the above steps.

When you select a print job added to Print Project in the Job Arranger Lite window, you can edit the page layout.

Click **Print** from the **File** menu to start printing.

**Note:**

*If you close the Job Arranger Lite window before adding all the print data to the Print Project, the print job you are currently working on is canceled. Click **Save** from the **File** menu to save the current job. The extension of the saved files is ".ecl".*

*To open a Print Project, click **Job Arranger Lite** on the printer driver's **Maintenance** tab to open the Job Arranger Lite window. Next, select **Open** from the **File** menu to select the file.*

### Related Information

- ➔ [“Printing Basics” on page 43](#)
- ➔ [“Main Tab” on page 58](#)

### Adjusting the Print Tone

You can adjust the tone used in the print job. These adjustments are not applied to the original data.

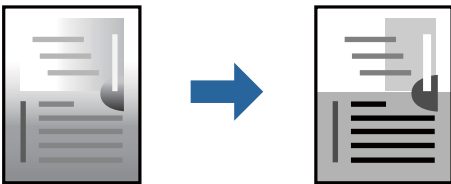

### Print Settings

On the printer driver's **More Options** tab, select **Custom** as the **Tone Correction** setting. Click **Advanced** to open the **Tone Correction** window, and then select the method of tone correction.

**Note:**

- Automatic** is selected as default on the **More Options** tab. This setting automatically adjusts the tone to match the paper type and print quality settings.*

### Related Information

- ➔ [“Printing Basics” on page 43](#)
- ➔ [“More Options Tab” on page 58](#)

## Printing to Emphasize Thin Lines

You can thicken thin lines that are too thin to print.

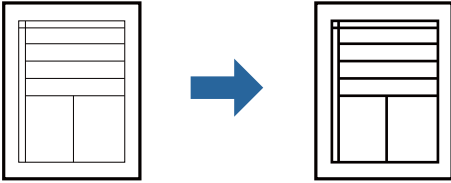

### Print Settings

On the printer driver's **More Options** tab, click **Image Options** in the **Tone Correction** setting. Select **Emphasize Thin Lines**.

#### Related Information

- ➔ [“Printing Basics” on page 43](#)
- ➔ [“More Options Tab” on page 58](#)

## Printing to Enhance Light Text and Lines

You can enhance light letters and lines to make them more visible, or to sharpen images.

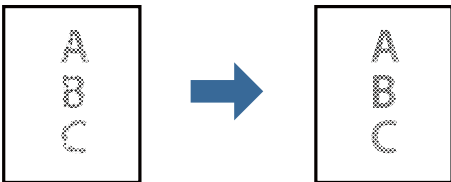

### Print Settings

On the printer driver's **More Options** tab, click **Image Options** in the **Tone Correction** setting. Select **Enhance Light Text and Lines**.

#### Related Information

- ➔ [“Printing Basics” on page 43](#)
- ➔ [“More Options Tab” on page 58](#)



## Printing

### Printing Clear Bar Codes

You can print a bar code clearly and make it easy to scan. Only enable this feature if the bar code you printed cannot be scanned.

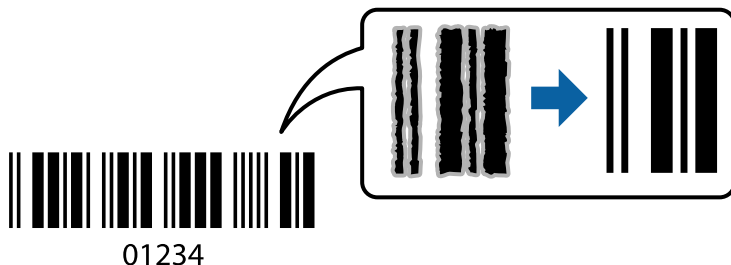

You can use this feature under the following conditions.

- Paper: Plain paper, Copy paper, Letterhead, High quality plain paper, Thick paper, or Envelope
- Quality: **Standard**

**Note:**

*Deblurring may not always be possible depending on the circumstances.*

### Print Settings

On the printer driver's **Maintenance** tab, click **Extended Settings**, and then select **Barcode mode**.

#### Related Information

- ➔ [“Printing Basics” on page 43](#)
- ➔ [“Maintenance Tab” on page 59](#)

### Canceling Printing

You can cancel a print job from the computer. However, you cannot cancel a print job from the computer once it has been completely sent to the printer. In this case, cancel the print job by using the printer's control panel.

### Canceling

On your computer, right-click on your printer in **Devices and Printers**, **Printer**, or in **Printers and Faxes**. Click **See what's printing**, right-click on the job you want to cancel, and then select **Cancel**.

### Menu Options for the Printer Driver

Open the print window in an application, select the printer, and then access the printer driver window.

**Note:**

*Menus vary depending on the option you selected.*

## Printing

### Main Tab

Printing Presets	Add/Remove Presets	You can add or remove your own presets for frequently used print settings. Select the preset you want to use from the list.
Show Settings	Displays a list of items currently set on the <b>Main</b> and <b>More Options</b> tabs.	
Reset Defaults	Return all settings to their factory default values. The settings on the <b>More Options</b> tab are also reset to their defaults.	
Ink Levels	Displays how to check the ink level.	
Paper Source	Select the paper source from which the paper is fed. Select <b>Auto Select</b> to feed paper from the rear paper feed slot when paper is loaded in the rear paper feed slot and the paper cassette.	
Document Size	Select the paper size on which you want to print. If you select <b>User-Defined</b> , enter the paper width and height.	
Orientation	Select the orientation you want to use to print.	
Paper Type	Select the type of paper on which you print.	
Quality	Select the print quality you want to use for printing. Available settings depend on the paper type you select.	
2-Sided Printing	Allows you to perform 2-sided printing.	
	Settings	You can specify the binding edge and the binding margins. When printing multi-page documents, you can select to print starting from either the front or the back side of the page.
	Print Density	Select the document type to adjust the print density. If the appropriate print density is selected, you can prevent images from bleeding through to the reverse side. Select <b>User Defined</b> to adjust the print density manually.
Multi-Page	Allows you to print several pages on one sheet or perform poster printing. Click <b>Page Order</b> to specify the order in which pages are printed.	
Copies	Set the number of copies you want to print.	
	Collate	Prints multi-page documents collated in order and sorted into sets.
	Reverse Order	Allows you to print from the last page so that the pages are stacked in the correct order after printing.
Quiet Mode	Reduces the noise the printer makes. However, enabling this may reduce print speed.	
Print Preview	Displays a preview of your document before printing.	
Job Arranger Lite	Select to print using the Job Arranger Lite feature.	

### More Options Tab

Printing Presets	Add/Remove Presets	You can add or remove your own presets for frequently used print settings. Select the preset you want to use from the list.
Show Settings	Displays a list of items currently set on the <b>Main</b> and <b>More Options</b> tabs.	

## Printing

Reset Defaults	Return all settings to their factory default values. The settings on the <b>Main</b> tab are also reset to their defaults.	
Document Size	Select the size of your document.	
Output Paper	Select the paper size on which you want to print. If the <b>Output Paper</b> differs from the <b>Document Size</b> , <b>Reduce/Enlarge Document</b> is selected automatically. You do not have to select it when printing without reducing or enlarging the size of a document.	
Reduce/Enlarge Document	Allows you to reduce or enlarge the size of a document.	
	Fit to Page	Automatically reduce or enlarge the document to fit to the paper size selected in <b>Output Paper</b> .
	Zoom to	Prints with a specific percentage.
	Center	Prints images in the center of the paper.
Tone Correction	Automatic	Adjusts the tone of images automatically.
	Custom	Allows you to perform manual tone correction. Click <b>Advanced</b> for further settings.
	Image Options	Enables print quality options such as Emphasize Text. You can also thicken thin lines to make them visible on the printouts.
Watermark Features	Allows you to make settings for anti-copy pattern or watermarks.	
Additional Settings	Rotate 180°	Rotates pages 180 degrees before printing. This feature is helpful when printing on paper such as envelopes that are loaded in fixed direction in the printer.
	High Speed	Prints when the print head moves in both directions. The print speed is faster, but the quality may decline.
	Mirror Image	Inverts an image to print as it would appear in a mirror.

## Maintenance Tab

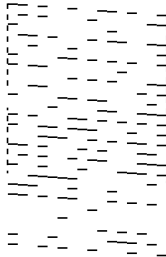
Nozzle Check	Prints a nozzle check pattern to check if the print head nozzles are clogged.
Head Cleaning	Cleans the clogged nozzles in the print head. Because this feature uses some ink, clean the print head only if some nozzles are clogged as shown in the illustration of the nozzle check pattern. <div style="text-align: center;">  </div>

## Printing

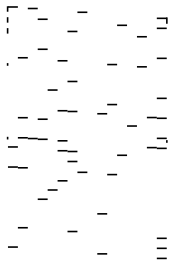
Power Cleaning	Runs power cleaning to clean the clogged nozzles in the print head. Because this feature uses more ink than head cleaning, run power cleaning only if most nozzles are clogged as shown in the illustration of the nozzle check pattern.  
Print Head Alignment	Aligns the print head if vertical lines are misaligned.
Paper Guide Cleaning	Cleans the paper path if the printouts are smeared.
Job Arranger Lite	Opens the Job Arranger Lite window. Here you can open and edit previously saved data.
EPSON Status Monitor 3	Opens the EPSON Status Monitor 3 window. Here you can confirm the status of the printer and the consumables.
Monitoring Preferences	Allows you to make settings for items on the EPSON Status Monitor 3 window.
Extended Settings	Allows you to make a variety of settings. Right-click each item to view the Help for more details.
Print Queue	Displays the jobs waiting to be printed. You can check, pause, or resume print jobs.
Printer and Option Information	Displays the number of sheets of paper fed into the printer.
Language	Changes the language used on the printer driver window. To apply the settings, close the printer driver, and then open it again.
Software Update	Starts EPSON Software Updater to check for the latest version of applications on the Internet.
Technical Support	Allows you to access the Epson technical support website.

## Printing from the Printer Driver on Mac OS

### Printing Basics

**Note:**

Operations differ depending on the application. See the application's help for details.

1. Open the file you want to print.  
Load paper in the printer if it has not already been loaded.
2. Select **Print** from the **File** menu or another command to access the print dialog.  
If necessary, click **Show Details** or ▼ to expand the print window.
3. Select your printer.

## Printing

4. Select **Print Settings** from the pop-up menu.

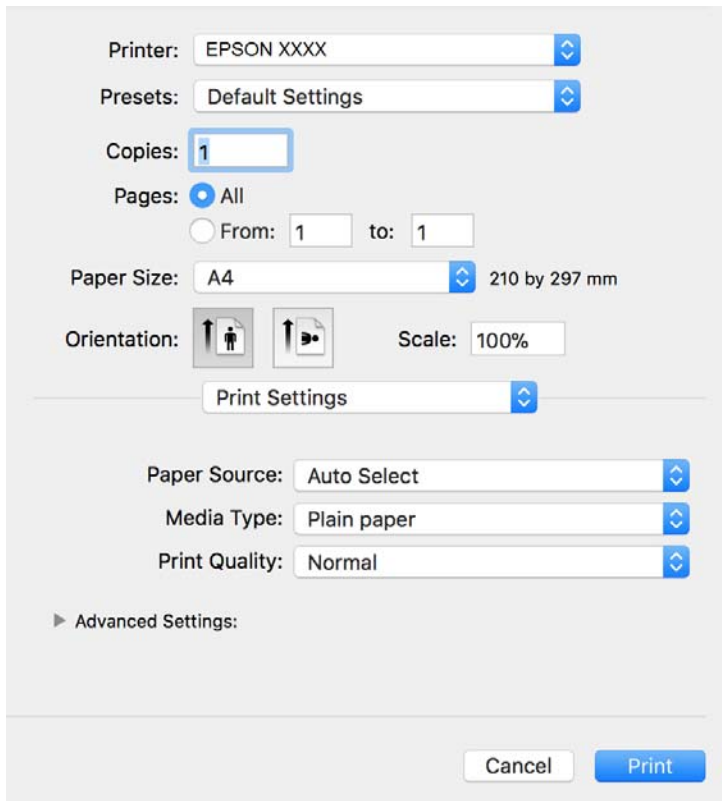

**Note:**

On OS X Mountain Lion or later, if the **Print Settings** menu is not displayed, the Epson printer driver has not been installed correctly.

Select **System Preferences** from the  menu > **Printers & Scanners** (or **Print & Scan, Print & Fax**), remove the printer, and then add the printer again. See the following to add a printer.

<http://epson.sn>

5. Change the settings as necessary.  
See the menu options for the printer driver for details.
6. Click **Print**.

### Related Information

- ➔ “Available Paper and Capacities” on page 32
- ➔ “Loading Paper in the Paper Cassette” on page 35
- ➔ “List of Paper Type” on page 40
- ➔ “Menu Options for Print Settings” on page 66

## Printing on 2-Sides

You can print on both sides of the paper.

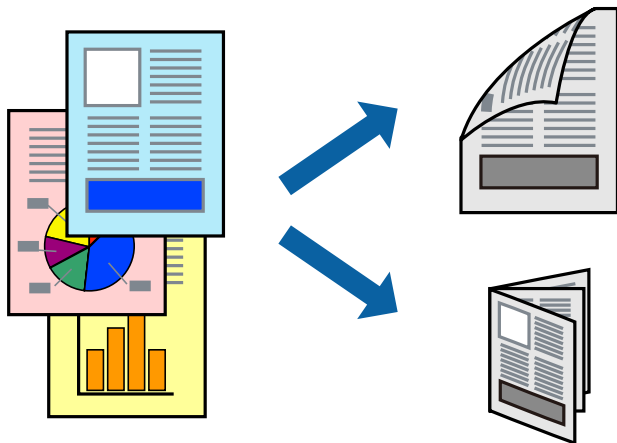

**Note:**

- If you do not use paper that is suitable for 2-sided printing, the print quality may decline and paper jams may occur.
- Depending on the paper and the data, ink may bleed through to the other side of the paper.

### Related Information

- ➔ [“Available Paper and Capacities” on page 32](#)

## Print Settings

Select **Two-sided Printing Settings** from the pop-up menu. Select the method of 2-sided printing, and then make the **Document Type** settings.

**Note:**

- Printing speed may be reduced depending on the document type.
- When printing photos with dense data, select **Text & Graphics** or **Text & Photos** in the **Document Type** setting. If the printouts are smeared or ink bleeds through to the other side of the paper, adjust the **Print Density** and **Increased Ink Drying Time** in **Adjustments**.

### Related Information

- ➔ [“Printing Basics” on page 60](#)
- ➔ [“Menu Options for Two-sided Printing Settings” on page 66](#)

## Printing

### Printing Several Pages on One Sheet

You can print several pages of data on a single sheet of paper.

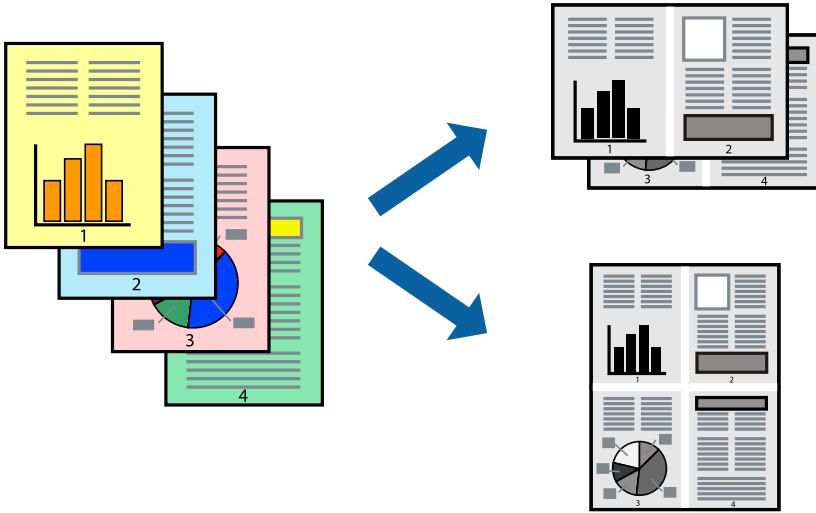

### Print Settings

Select **Layout** from the pop-up menu. Set the number of pages in **Pages per Sheet**, the **Layout Direction** (page order), and **Border**.

#### Related Information

- ➔ [“Printing Basics” on page 60](#)
- ➔ [“Menu Options for Layout” on page 65](#)

### Printing and Stacking in Page Order (Reverse Order Printing)

You can print from the last page so that documents are stacked in page order for outputting paper to the front of the printer.

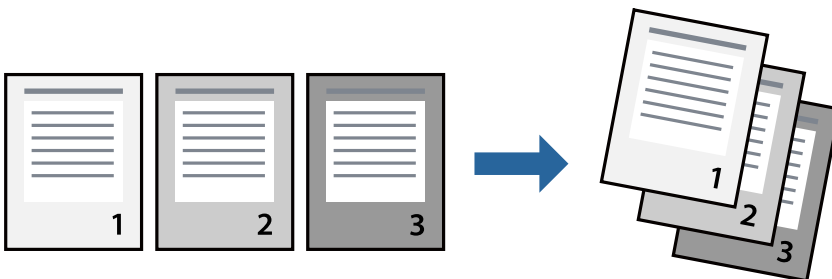

### Print Settings

Select **Paper Handling** from the pop-up menu. Select **Reverse** as the **Page Order** setting.

## Printing

### Related Information

- ➔ [“Printing Basics” on page 60](#)
- ➔ [“Menu Options for Paper Handling” on page 65](#)

## Printing a Reduced or Enlarged Document

You can reduce or enlarge the size of a document by a specific percentage or to fit the paper size you loaded in the printer.



## Print Settings

When printing to fit to the paper size, select **Paper Handling** from the pop-up menu, and then select **Scale to fit paper size**. Select the paper size you loaded in the printer in **Destination Paper Size**. When reducing the size of the document, select **Scale down only**.

When printing at a specific percentage, do one of the following.

- Select **Print** from the **File** menu of the application. Select **Printer**, enter a percentage in **Scale**, and then click **Print**.
- Select **Page Setup** from the **File** menu of the application. Select your printer in **Format For**, enter a percentage in **Scale**, and then click **OK**.

**Note:**

Select the paper size you set in the application as the **Paper Size** setting.

### Related Information

- ➔ [“Printing Basics” on page 60](#)
- ➔ [“Menu Options for Paper Handling” on page 65](#)

## Canceling Printing

You can cancel a print job from the computer. However, you cannot cancel a print job from the computer once it has been completely sent to the printer. In this case, cancel the print job by using the printer's control panel.



## Printing

### Canceling

Click the printer icon in the **Dock**. Select the job you want to cancel, and then do one of the following.

- OS X Mountain Lion or later

Click  next to the progress meter.

- Mac OS X v10.6.8 to v10.7.x

Click **Delete**.

### Menu Options for the Printer Driver

Open the print window in an application, select the printer, and then access the printer driver window.

**Note:**

*Menus vary depending on the option you selected.*

### Menu Options for Layout

Pages per Sheet	Select the number of pages to be printed on one sheet.
Layout Direction	Specify the order in which the pages will be printed.
Border	Prints a border around the pages.
Reverse page orientation	Rotates pages 180 degrees before printing. Select this item when printing on paper such as envelopes that are loaded in fixed direction in the printer.
Flip horizontally	Inverts an image to print as it would appear in a mirror.

### Menu Options for Color Matching

ColorSync	Select the method for color adjustment. These options adjust colors between the printer and the computer display to minimize the difference in color.
EPSON Color Controls	

### Menu Options for Paper Handling

Collate pages	Prints multi-page documents collated in order and sorted into sets.	
Pages to Print	Select to print only odd pages or even pages.	
Page Order	Select to print from the top or the last page.	
Scale to fit paper size	Prints to fit to the paper size you loaded.	
	Destination Paper Size	Select the paper size to print on.
	Scale down only	Select when reducing the size of the document.

## Printing

### Menu Options for Cover Page

Print Cover Page	Select whether or not to print a cover page. When you want to add a back cover, select <b>After document</b> .
Cover Page Type	Select the contents of the cover page.

### Menu Options for Print Settings

Paper Source	Select the paper source from which the paper is fed. If the printer has only one paper source, this item is not displayed. Selecting <b>Auto Select</b> selects the paper source that matches the paper setting on the printer automatically.
Media Type	Select the type of paper on which you print.
Print Quality	Select the print quality you want to use for printing. The options vary depending on the paper type.
Advanced Settings	Adjusts the brightness and the contrast of images.

### Menu Options for Two-sided Printing Settings

Two-sided Printing	Prints on both sides of the paper.
--------------------	------------------------------------

## Making Operation Settings for the Mac OS Printer Driver

### Accessing the Operation Settings Window of the Mac OS Printer Driver

Select **System Preferences** from the  menu > **Printers & Scanners** (or **Print & Scan**, **Print & Fax**), and then select the printer. Click **Options & Supplies** > **Options** (or **Driver**).

### Operation Settings for Mac OS Printer Driver

- Skip Blank Page: Avoids printing blank pages.
- Quiet Mode: Reduces the noise the printer makes, however, may reduce print speed.
- High Speed Printing: Prints when the print head moves in both directions. The print speed is faster, but the quality may decline.
- Warning Notifications: Allows the printer driver to display warning notifications.
- Establish bidirectional communication: Usually, this should be set to **On**. Select **Off** when acquiring the printer information is impossible because the printer is shared with Windows computers on a network or for any other reason.

---

## Printing from Smart Devices

### Using Epson iPrint

Epson iPrint is an application that allows you to print photos, documents, and web pages from a smart device such as a smartphone or tablet. You can use local print, printing from a smart device that is connected to the same wireless network as your printer, or remote print, printing from a remote location over the Internet. To use remote print, register your printer in the Epson Connect service.

If you start Epson iPrint when the printer is not connected to the network, a message is displayed instructing you to connect to the printer. Follow the instructions to complete the connection. See the URL below for the operating conditions.

<http://epson.sn>



#### Related Information

➔ “Printing Using a Network Service” on page 96

### Installing Epson iPrint

You can install Epson iPrint on your smart device from the following URL or QR code.

<http://ipr.to/c>



### Printing Using Epson iPrint

Start Epson iPrint from your smart device and select the item you want to use from the home screen.

## Printing

The following screens are subject to change without notice. The contents may vary depending on the product.

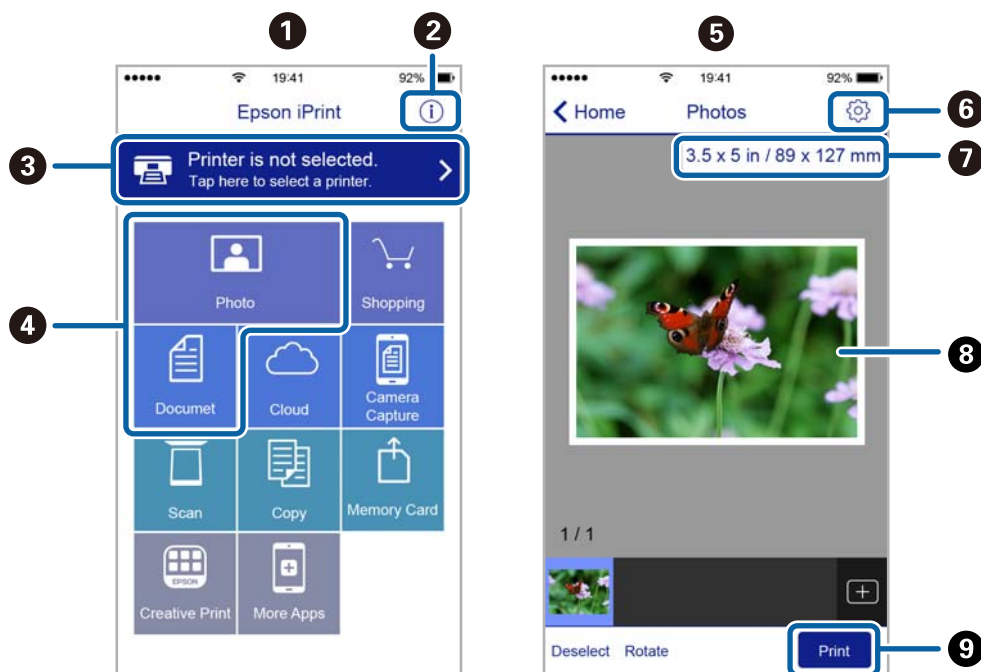

1	Home screen displayed when the application is started.
2	Displays information on how to setup the printer and a FAQ.
3	Displays the screen where you can select the printer and make printer settings. Once you have selected the printer, you do not need to select it again from the next time.
4	Select what you want to print such as photos and documents.
5	The print photos screen displayed when the photo menu is selected.
6	Displays the screen to make print settings such as paper size and paper type.
7	Displays the paper size. When this is displayed as a button, tap it to display the paper settings currently set on the printer.
8	Displays photos and documents you selected.
9	Starts printing.

**Note:**

To print from the document menu using iPhone, iPad, and iPod touch running iOS, start Epson iPrint after transferring the document you want to print using the file sharing function in iTunes.

## Using Epson Print Enabler

You can wirelessly print your documents, emails, photos, and web pages right from your Android phone or tablet (Android v4.4 or later). With a few taps, your Android device will discover an Epson printer that is connected to the same wireless network.

**Note:**

Operations may differ depending on the device.

## Printing

1. Load paper in the printer.
2. Set up your printer for wireless printing.
3. On your Android device, install the Epson Print Enabler plug-in from Google Play.
4. Connect your Android device to the same wireless network as your printer.
5. Go to **Settings** on your Android device, select **Connected devices** > **Printing**, and then enable Epson Print Enabler.
6. From an Android application such as Chrome, tap the menu icon and print whatever is on the screen.

**Note:**

*If you do not see your printer, tap **All Printers** and select your printer.*

### Related Information

- ➔ [“Loading Paper in the Paper Cassette” on page 35](#)
- ➔ [“Connecting to a Smart Device” on page 19](#)

---

## Canceling Printing - Printer Button

Press the  button to cancel the print job in progress.

# Refilling Ink and Replacing Maintenance Boxes

---

## Checking the Status of the Remaining Ink and the Maintenance Box

To confirm the actual ink remaining, visually check the ink level in the printer's tank.

You can check the approximate service life of the maintenance box from the computer.

### Checking the Status of the Maintenance Box - Windows

1. Access the printer driver window.
2. Click **EPSON Status Monitor 3** on the **Maintenance** tab.



**Note:**

*If EPSON Status Monitor 3 is disabled, click **Extended Settings** on the **Maintenance** tab, and then select **Enable EPSON Status Monitor 3**.*

#### Related Information

➔ [“Accessing the Printer Driver” on page 43](#)

### Checking the Status of the Maintenance Box - Mac OS X

1. Start the printer driver utility:
  - Mac OS X v10.6.x to v10.9.x  
Select **System Preferences** from the  menu > **Printers & Scanners** (or **Print & Scan, Print & Fax**) and then select the printer. Click **Options & Supplies** > **Utility** > **Open Printer Utility**.
  - Mac OS X v10.5.8  
Select **System Preferences** from the  menu > **Print & Fax**, and then select the printer. Click **Open Print Queue** > **Utility**.
2. Click **EPSON Status Monitor**.

---

## Ink Bottle Codes

Epson recommends the use of genuine Epson ink bottles.

The following are the codes for genuine Epson ink bottles.

## Refilling Ink and Replacing Maintenance Boxes

**!** **Important:**

- ❑ *Epson warranty does not cover damage caused by inks other than those specified, including any genuine Epson ink not designed for this printer or any third party ink.*
- ❑ *Other products not manufactured by Epson may cause damage that is not covered by Epson's warranties, and under certain circumstances, may cause erratic printer behavior.*

**Note:**

- ❑ *Ink bottle codes may vary by location. For the correct codes in your area, contact Epson support.*
- ❑ *Although the ink bottles may contain recycled materials, this does not affect printer function or performance.*
- ❑ *Specifications and appearance of the ink bottle are subject to change without prior notice for improvement.*

For Europe

Product	BK: Black
ET-M1170 Series	111
M1170 Series	110* <sup>1</sup> 110S* <sup>2</sup>

\*1 High capacity

\*2 Standard capacity

**Note:**

*For users in Europe, visit the following website for information on Epson's ink bottle yields.*

<http://www.epson.eu/pageyield>

For Australia and New Zealand

BK: Black
532

For Asian countries except for China

BK: Black
005* <sup>1</sup> 005S * <sup>2</sup>

\*1 High capacity

\*2 Standard capacity

**Related Information**

➔ [“Technical Support Web Site” on page 133](#)

---

## Ink Bottle Handling Precautions

Read the following instructions before refilling ink.

### Storing precautions for ink

- Keep the ink bottles out of direct sunlight.
- Do not store the ink bottles in high or freezing temperatures.
- After bringing an ink bottle inside from a cold storage site, allow it to warm up at room temperature for at least three hours before using it.
- Once you open an ink bottle, we recommend using it as soon as possible.
- Epson recommends using the ink bottle before the date printed on the package.
- Do not open the ink bottle package until you are ready to fill the ink tank. The ink bottle is vacuum packed to maintain its reliability. If you leave an ink bottle unpacked for a long time before using it, normal printing may not be possible.
- When storing or transporting an ink bottle, do not tilt the bottle and do not subject it to impacts or temperature changes. Otherwise, ink may leak even if the cap on the ink bottle is tightened securely. Be sure to keep the ink bottle upright when tightening the cap, and take precautions to prevent ink from leaking when transporting the bottle, for example, putting the bottle in a bag.

### Handling precautions for refilling ink

- The ink for this printer must be handled carefully. Ink may splatter when the ink tank is being filled or refilled with ink. If ink gets on your clothes or belongings, it may not come off.
- Use ink bottles with the correct part code for this printer.
- Do not shake too vigorously or squeeze the ink bottles.
- For optimum print results do not maintain low ink levels for extended periods of time.
- To obtain optimum printing results, refill the ink tank to the upper line at least once every year.
- To ensure you receive premium print quality and to help protect your print head, a variable ink safety reserve remains in the ink tank when your printer indicates to refill ink. The yields quoted for you do not include this reserve.

### Ink consumption

- To maintain optimum print head performance, some ink is consumed from the ink tank during maintenance operations such as print head cleaning. Ink may also be consumed when you turn the printer on.
- The ink in the ink bottle supplied with your printer is partly used during initial setup. In order to produce high quality printouts, the print head in your printer will be fully charged with ink. This one-off process consumes a quantity of ink and therefore this bottle may print fewer pages compared to subsequent ink bottles.
- Quoted yields may vary depending on the images that you are printing, the paper type that you are using, the frequency of your prints and environmental conditions such as temperature.



## Refilling the Ink Tank



**Important:**

*Epson recommends the use of genuine Epson ink bottles.*

1. Open the ink tank cover.

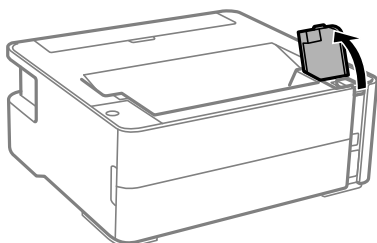

2. Open the cap of the ink tank.

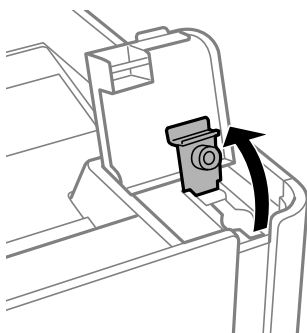

3. While holding the ink bottle upright, turn the cap slowly to remove it.

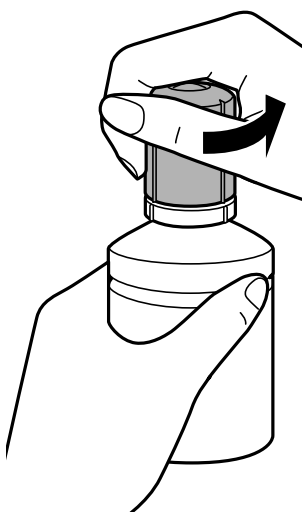

**Important:**

- ❑ Be careful not to spill any ink.
- ❑ Do not touch the top of the ink bottle after removing the cap; otherwise you may be smeared with ink.

### Refilling Ink and Replacing Maintenance Boxes

4. Align the tip of the bottle with the filling port, and then stand the bottle slowly to insert it into the filling port.

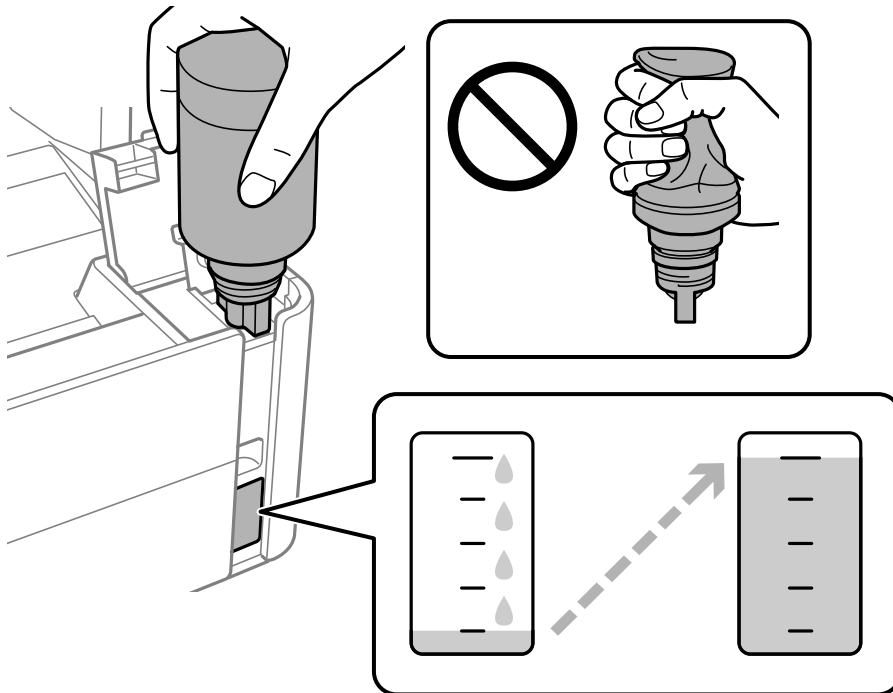

**Important:**

Do not allow the top of the ink bottle to hit against any objects after removing its cap; otherwise ink may spill.

**Note:**

If the ink does not start flowing into the tank, remove the ink bottle and try reinserting it.

5. When the ink reaches the upper line, pull out the bottle.

Ink pours into the tank just by holding the bottle normally without squeezing. The ink flow stops automatically when the ink is filled to the upper line.

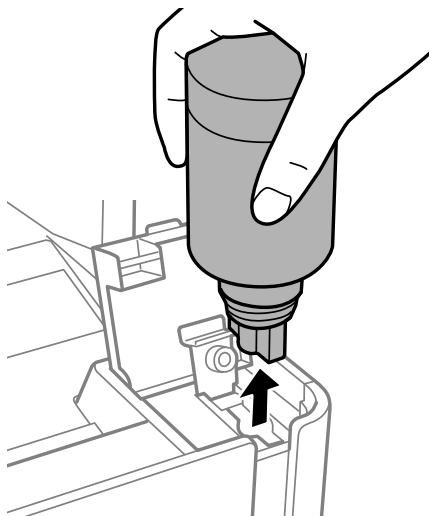

## Refilling Ink and Replacing Maintenance Boxes

**!** *Important:*

*Do not leave the ink bottle inserted; otherwise the bottle may be damaged or ink may leak.*

6. Tighten the cap of the ink bottle.

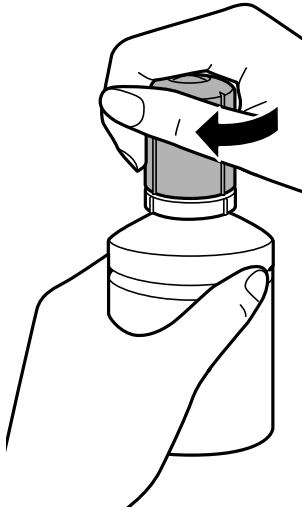

**Note:**

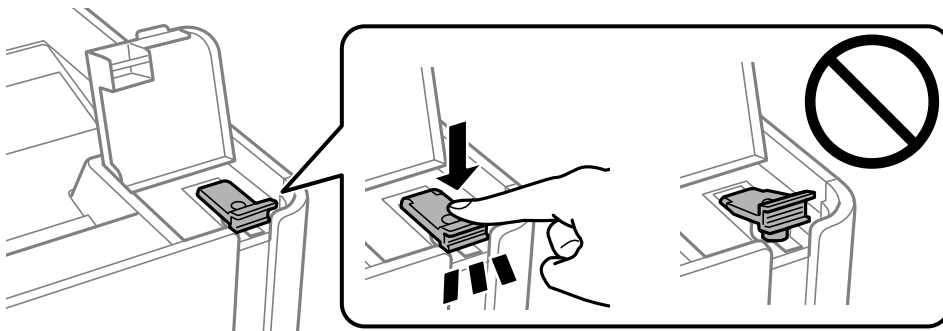

*If any ink remains in the ink bottle, tighten the cap and store the bottle upright for later use.*

7. Close the ink tank cap securely.

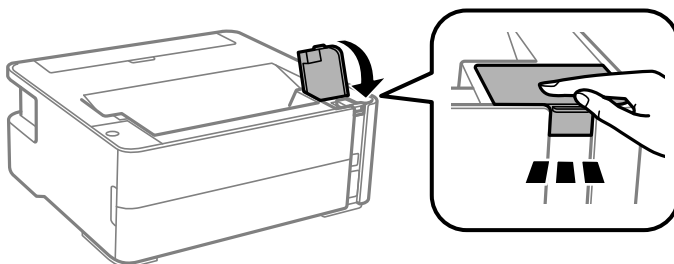

8. Close the ink tank cover firmly.



9. If the  light flashes, press the  button.

## Refilling Ink and Replacing Maintenance Boxes

### Related Information

- ➔ [“Ink Bottle Codes” on page 70](#)
- ➔ [“Ink Bottle Handling Precautions” on page 72](#)
- ➔ [“Ink Spilled” on page 122](#)

---

## Maintenance Box Code

The maintenance box can be purchased and replaced by the user.

Epson recommends the use of a genuine Epson maintenance box.

The following is the code for the genuine Epson maintenance box.

T04D1



**Important:**

*Once a maintenance box has been installed in a printer it cannot be used with other printers.*

---

## Maintenance Box Handling Precautions

Read the following instructions before replacing the maintenance box.

- Do not touch the green chip on the side of the maintenance box. Doing so may prevent normal operation and printing.
- Do not drop the maintenance box or subject it to strong shocks.
- Do not replace the maintenance box during printing; otherwise, ink may leak.
- Do not remove the maintenance box and its cover except when replacing the maintenance box; otherwise ink may leak.
- When the cover cannot be reattached, the maintenance box may not be installed correctly. Remove the maintenance box, and re-install it.
- Do not tilt the used maintenance box until after it is sealed in the plastic bag; otherwise ink may leak.
- Do not touch the openings in the maintenance box as you may get smeared with ink.
- Do not reuse a maintenance box which has been removed and left detached for a long period. Ink inside the box will have solidified and no more ink can be absorbed.
- Keep the maintenance box out of direct sunlight.
- Do not store the maintenance box in high or freezing temperatures.

---

## Replacing a Maintenance Box

In some print cycles a very small amount of surplus ink may be collected in the maintenance box. To prevent ink leakage from the maintenance box, the printer is designed to stop printing when the absorbing capacity of the maintenance box has reached its limit. Whether and how often this is required will vary according to the number of pages you print, the type of material that you print and the number of cleaning cycles that the printer performs. Replace the maintenance box when you are promoted to do so. The Epson Status Monitor, your LCD, or lights on

## Refilling Ink and Replacing Maintenance Boxes

the control panel will advise you when this part needs replacing. The need for replacement of the box does not mean that your printer has ceased to operate in accordance with its specifications. The Epson warranty does not cover the cost of this replacement. It is a user-serviceable part.

**Note:**

*When it is full, you cannot print and clean the print head until the maintenance box is replaced to avoid ink leakage.*

1. Remove the new maintenance box from its package.



**Important:**

*Do not touch the green chip on the side of the maintenance box. Doing so may prevent normal operation and printing.*

**Note:**

*A transparent bag for the used maintenance box is provided with the new maintenance box.*

2. Loosen the screw with a flat-head screwdriver, and then remove the cover.

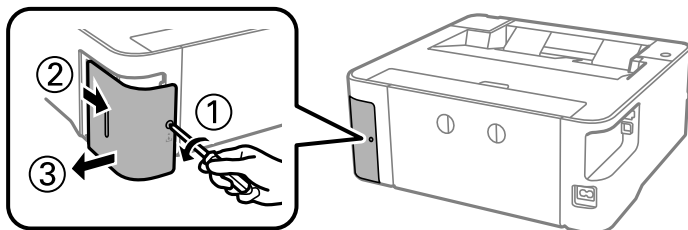

3. Remove the used maintenance box.

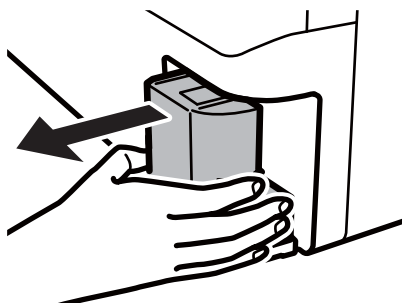

**Important:**

*Do not touch the sections shown in the illustration. Doing so may prevent normal operation and you may get smeared with ink.*

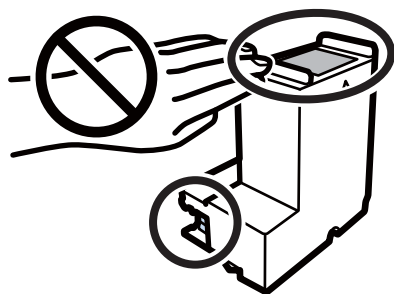

## Refilling Ink and Replacing Maintenance Boxes

- Put the used maintenance box in the transparent bag that came with the new maintenance box and seal the bag shut.

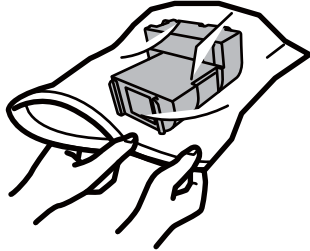

- Insert the new maintenance box all the way into the printer. Make sure you insert the box in the correct direction.

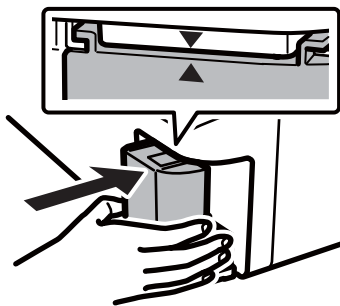

- Reattach the cover.

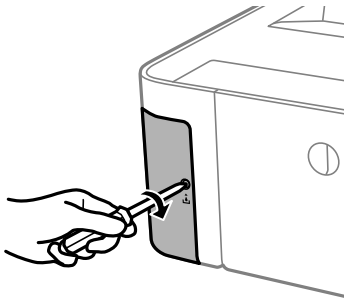

### Related Information

- ➔ [“Maintenance Box Code” on page 76](#)
- ➔ [“Maintenance Box Handling Precautions” on page 76](#)

# Maintaining the Printer

---

## Preventing the Print Head from Drying

Always use the power button when turning the printer on and off.

Check that the power light is off before you disconnect the power cord.

The ink itself can dry out if it is not covered. Just like placing a cap on a fountain pen or an oil pen to prevent it from drying, make sure the print head is capped properly to prevent the ink from drying.

When the power cord is unplugged or a power outage occurs while the printer is in operation, the print head may not be capped properly. If the print head is left as it is, it will dry out causing nozzles (ink outlets) to clog.

In these cases, turn the printer on and off again as soon as possible to cap the print head.



---

## Check if Nozzles are Clogged (Nozzle Check)

If the nozzles are clogged, the printouts become faint or visible banding appears.

When print quality has declined, first use the nozzle check feature to check if the nozzles are clogged.

### Check if Nozzles are Clogged (Nozzle Check) - Printer Buttons

1. Load A4-size plain paper in the paper cassette.
2. Press the  button to turn off the printer.
3. While holding down the , press the  button to turn on the printer for at least five seconds until the power light flashes.

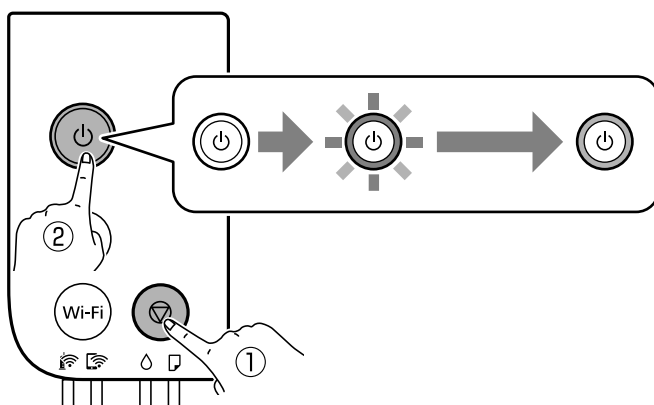

The nozzle check pattern is printed.

**Note:**

*It may take some time to start printing the nozzle check pattern.*

### Maintaining the Printer

- Examine the printed pattern, and then perform one of the following options depending on the print results.

**A) OK**

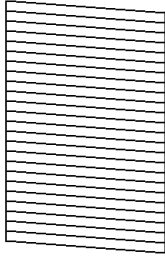

**B) NG**

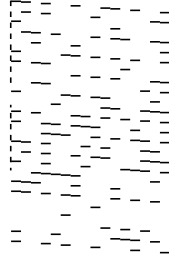

**C) NG**



A:

All lines are printed. No further steps are needed.

B or close to B: Clean the print head.

When some nozzles are clogged, perform head cleaning. For details, see the related information below.

C or close to C: Power Clean the print head.

When most lines are broken or most segments are missing, perform power cleaning. For details, see the related information below.

**Related Information**

- ➔ [“Loading Paper in the Paper Cassette” on page 35](#)
- ➔ [“Cleaning the Print Head \(Head Cleaning\)” on page 82](#)
- ➔ [“Power Cleaning the Print Head \(Power Cleaning\)” on page 83](#)

## Check if Nozzles are Clogged (Nozzle Check) - Windows

- Load A4-size plain paper in the paper cassette.
- Access the printer driver window.
- Click **Nozzle Check** on the **Maintenance** tab.
- Follow the on-screen instructions to print the nozzle check pattern.
- Examine the printed pattern, and then perform one of the following options depending on the print results.

**A) OK**

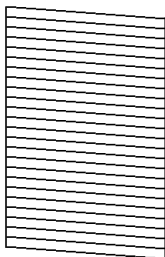

**B) NG**

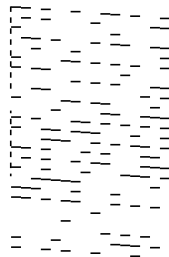

**C) NG**

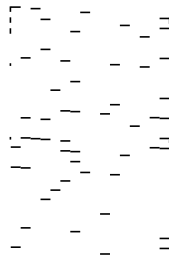



## Maintaining the Printer

A:

All lines are printed. No further steps are needed.

B or close to B: Clean the print head.

When some nozzles are clogged, perform head cleaning. For details, see the related information below.

C or close to C: Power Clean the print head.

When most lines are broken or most segments are missing, perform power cleaning. For details, see the related information below.

### Related Information

- ➔ [“Accessing the Printer Driver” on page 43](#)
- ➔ [“Loading Paper in the Paper Cassette” on page 35](#)
- ➔ [“Cleaning the Print Head \(Head Cleaning\)” on page 82](#)
- ➔ [“Power Cleaning the Print Head \(Power Cleaning\)” on page 83](#)

## Check if Nozzles are Clogged (Nozzle Check) - Mac OS

1. Load A4-size plain paper in the paper cassette.
2. Select **System Preferences** from the  menu > **Printers & Scanners** (or **Print & Scan, Print & Fax**), and then select the printer.
3. Click **Options & Supplies** > **Utility** > **Open Printer Utility**.
4. Click **Nozzle Check**.
5. Follow the on-screen instructions to print the nozzle check pattern.
6. Examine the printed pattern, and then perform one of the following options depending on the print results.

**A) OK**

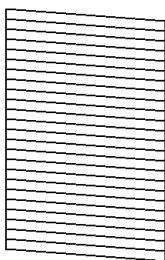

**B) NG**

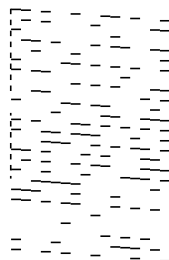

**C) NG**

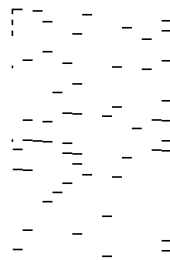

A:

All lines are printed. No further steps are needed.

B or close to B: Clean the print head.

When some nozzles are clogged, perform head cleaning. For details, see the related information below.

C or close to C: Power Clean the print head.

When most lines are broken or most segments are missing, perform power cleaning. For details, see the related information below.

## Maintaining the Printer

### Related Information

- ➔ [“Loading Paper in the Paper Cassette” on page 35](#)
- ➔ [“Cleaning the Print Head \(Head Cleaning\)” on page 82](#)
- ➔ [“Power Cleaning the Print Head \(Power Cleaning\)” on page 83](#)

---

## Cleaning the Print Head (Head Cleaning)

When printouts are faint or visible banding appears, the nozzles are clogged. When print quality has declined, use the nozzle check feature to check if the nozzles are clogged, and then clean the print head. For details on how to run the nozzle check, see the related information below.



### **Important:**

- Do not open the printer cover or turn off the printer during head cleaning. If the head cleaning is incomplete, you may not be able to print.
- Because print head cleaning uses some ink, clean the print head only if quality declines.
- When ink is low, you may not be able to clean the print head.
- If print quality has not improved after repeating nozzle check and head cleaning three times, wait for at least six hours without printing, and then run the nozzle check again. We recommend to turn off the printer. If print quality has still not improved, run Power Cleaning. If it has still not improved, contact Epson support.
- To prevent the print head from drying out, do not unplug the printer while the power is on.

### Related Information

- ➔ [“Check if Nozzles are Clogged \(Nozzle Check\)” on page 79](#)

## Cleaning the Print Head - Printer Buttons

Hold the  button down for at least five seconds until the power light starts flashing.

Print head cleaning starts.

### **Note:**

*It may take some time to start print head cleaning.*

After the power light stops flashing, turn off the printer, run nozzle check, and then check if the print head nozzles have been un-clogged.

For details on how to run the nozzle check, see the related information below.

Repeat the nozzle check and head cleaning up to three times until all lines are printed correctly.

### Related Information

- ➔ [“Check if Nozzles are Clogged \(Nozzle Check\)” on page 79](#)

## Cleaning the Print Head - Windows

1. Access the printer driver window.

## Maintaining the Printer

2. Click **Head Cleaning** on the **Maintenance** tab.
3. Follow the on-screen instructions.

After the print head cleaning is finished, run **Nozzle Check** and then check if the print head nozzles have been unclogged. For details on how to run the nozzle check, see the related information below.

Repeat the steps up to three times until all lines are printed correctly.

### Related Information

- ➔ [“Accessing the Printer Driver” on page 43](#)
- ➔ [“Check if Nozzles are Clogged \(Nozzle Check\)” on page 79](#)

## Cleaning the Print Head - Mac OS

1. Select **System Preferences** from the  menu > **Printers & Scanners** (or **Print & Scan, Print & Fax**), and then select the printer.
2. Click **Options & Supplies** > **Utility** > **Open Printer Utility**.
3. Click **Head Cleaning**.
4. Follow the on-screen instructions.

After the print head cleaning is finished, run **Nozzle Check** and then check if the print head nozzles have been unclogged. For details on how to run the nozzle check, see the related information below.

Repeat the steps up to three times until all lines are printed correctly.

### Related Information

- ➔ [“Check if Nozzles are Clogged \(Nozzle Check\)” on page 79](#)

---

## Power Cleaning the Print Head (Power Cleaning)

The power cleaning feature may improve print quality in the following cases.

- The most nozzles are clogged.
- You performed the nozzle check and head cleaning three times and then waited for at least six hours without printing, but print quality still did not improve.

Before running this feature, use the nozzle check feature to check if the nozzles are clogged, read the following instructions, and then power clean the print head.

**Important:**

*Make sure that there is enough ink in the ink tank.*

*Visually check the ink tank is at least a third full. Low ink levels during Power Cleaning could damage the product.*

## Maintaining the Printer

**!** **Important:**

An interval of 12 hours is required between each Power Cleaning.

Normally, a single Power Cleaning should resolve the print quality issue within 12 hours. Therefore, to avoid unnecessary ink usage, you must wait 12 hours before you try it again.

**!** **Important:**

Maintenance box replacement may be required.

Ink will be deposited to the maintenance box. If it becomes full, you must prepare and install a replacement maintenance box to continue printing.

**Note:**

When the ink levels or the free space in the maintenance box are insufficient for Power Cleaning, you cannot run this feature. Even in this case, the levels and the free space for printing may remain.

**Related Information**

➔ [“Check if Nozzles are Clogged \(Nozzle Check\)” on page 79](#)

## Running Power Cleaning - Windows

1. Access the printer driver window.
2. Click **Power Cleaning** on the **Maintenance** tab.
3. Follow the on-screen instructions.

**Related Information**

➔ [“Accessing the Printer Driver” on page 43](#)

➔ [“Check if Nozzles are Clogged \(Nozzle Check\)” on page 79](#)

## Running Power Cleaning - Mac OS

1. Select **System Preferences** from the  menu > **Printers & Scanners** (or **Print & Scan, Print & Fax**), and then select the printer.
2. Click **Options & Supplies** > **Utility** > **Open Printer Utility**.
3. Click **Power Cleaning**.
4. Follow the on-screen instructions.

**Related Information**

➔ [“Check if Nozzles are Clogged \(Nozzle Check\)” on page 79](#)

---

## Aligning the Print Head

If you notice a misalignment of vertical lines or blurred images, align the print head.

### Aligning the Print Head - Windows

1. Load four or more sheets of A4-size plain paper in the printer.
2. Access the printer driver window.
3. Click **Print Head Alignment** on the **Maintenance** tab.
4. Follow the on-screen instructions.

### Aligning the Print Head - Mac OS

1. Load four or more sheets of A4-size plain paper in the printer.
2. Select **System Preferences** from the  menu > **Printers & Scanners** (or **Print & Scan**, **Print & Fax**), and then select the printer.
3. Click **Options & Supplies** > **Utility** > **Open Printer Utility**.
4. Click **Print Head Alignment**.
5. Follow the on-screen instructions.

---

## Cleaning the Paper Path

When the printouts are smeared or scuffed or paper does not feed correctly, clean the roller inside.

**Important:**

*Do not use tissue paper to clean the inside of the printer. The print head nozzles may be clogged with lint.*

### Cleaning the Paper Path - Windows

1. Access the printer driver window.
2. Click **Paper Guide Cleaning** on the **Maintenance** tab.
3. Follow the on-screen instructions.

#### Related Information

➔ [“Loading Paper in the Paper Cassette” on page 35](#)

## Maintaining the Printer

### Cleaning the Paper Path - Mac OS X

1. Select **System Preferences** from the  menu > **Printers & Scanners** (or **Print & Scan**, **Print & Fax**), and then select the printer.
2. Click **Options & Supplies** > **Utility** > **Open Printer Utility**.
3. Click **Paper Guide Cleaning**.
4. Follow the on-screen instructions.

#### Related Information

➔ [“Loading Paper in the Paper Cassette” on page 35](#)

---

### Cleaning the Paper Path for Paper Feeding Problems

When paper is not fed from paper cassette correctly, clean the roller inside.

1. Turn off the printer by pressing the  button.
2. Unplug the power cord, and then disconnect the power cord.
3. Make sure that the ink tank cap is securely closed.

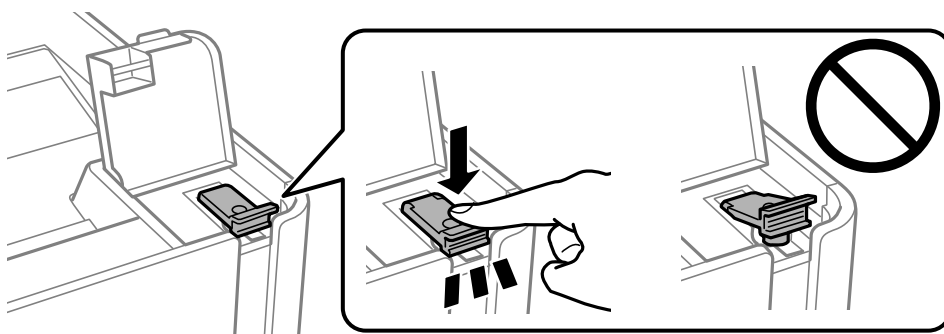
**Important:**

*If the ink tank cap is not securely closed, ink may leak.*

4. the printer cover.

## Maintaining the Printer

- Slide out the paper cassette, and then remove the paper.

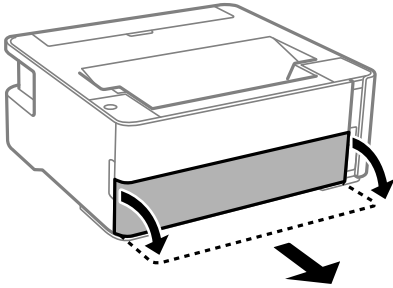

- Stand the printer on its side with the printer's ink tank at the bottom.

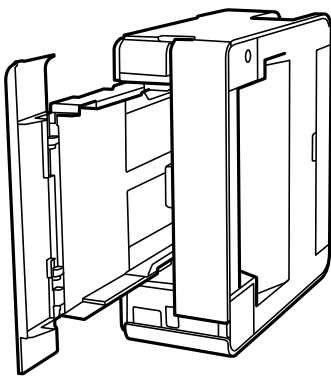

**Caution:**

*Be careful not to trap your hand or fingers when standing the printer. Otherwise you may be injured.*



**Important:**

*Do not leave the printer standing for a long time.*

- Dampen a soft cloth with water, wring it out thoroughly, and then wipe the roller while rotating it with the cloth.

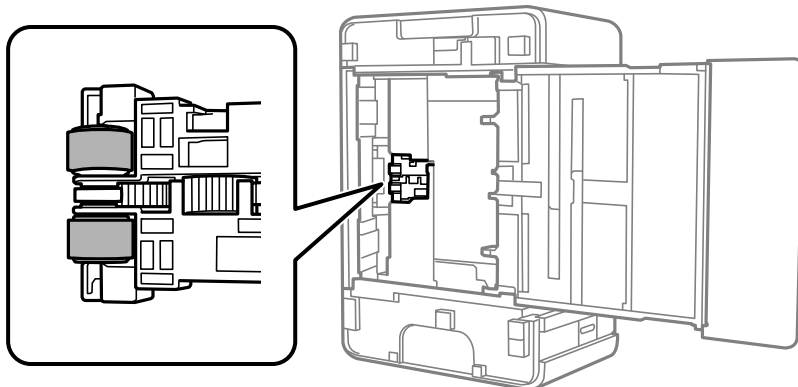

- Return the printer to its normal position, and then insert the paper cassette.
- Connect the power cord.

## Cleaning the Translucent Film

When the printout is not improved after aligning the print head or cleaning the paper path, the translucent film inside the printer may be smeared.

Items required:

- Cotton swabs (several)
- Water with a few drops of detergent (2 to 3 drops of detergent in 1/4 cup of tap water)
- Light for checking smears



**Important:**

*Do not use cleaning liquid other than water with a few drops of detergent.*

1. Turn off the printer by pressing the  button.
2. Open the printer cover.

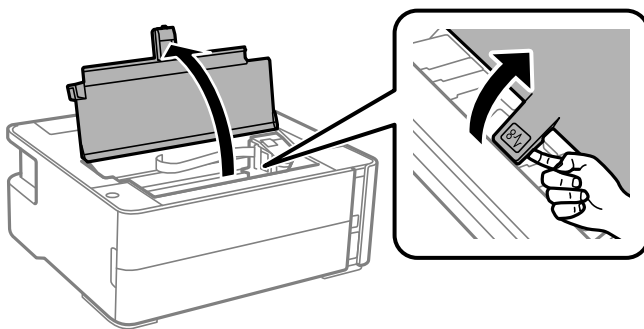

3. Check if the translucent film is smeared. Smears are easier to see if you use a light. If there are smears (such as finger marks or grease) on the translucent film (A), go to the next step.

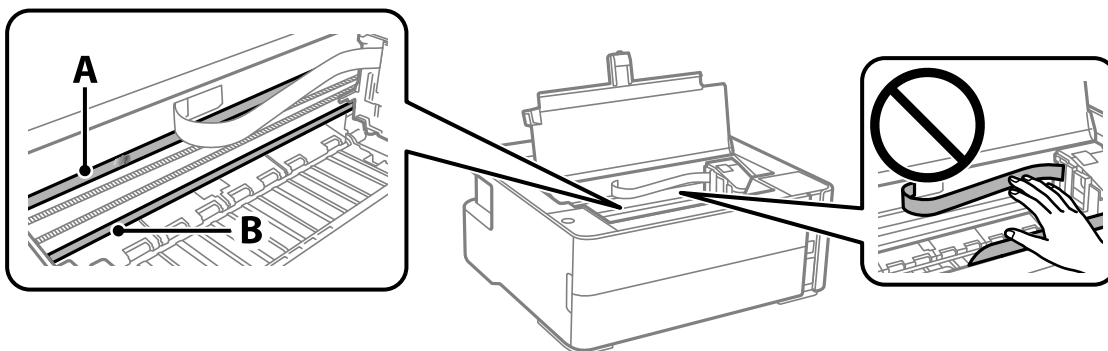

A: Translucent film

B: Rail



**Important:**

*Be careful not to touch the rail (B). Otherwise, you may not be able to print. Do not wipe off the grease on the rail, because this is necessary for operations.*



## Maintaining the Printer

- Moisten a cotton swab with the water with a few drops of detergent so that it is not dripping water, and then wipe the smeared part.

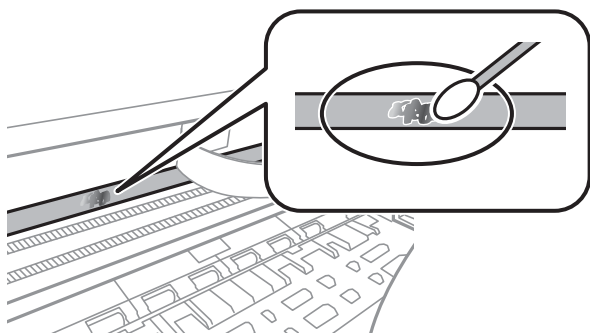

**!** **Important:**

*Wipe off the smear gently. If you press the cotton swab too hard to the film, the springs of the film may be dislocated and the printer may be damaged.*

- Use a new dry cotton swab to wipe the film.

**!** **Important:**

*Do not leave any fibers on the film.*

**Note:**

*To prevent the smear from spreading, frequently replace the cotton swab with a new one.*

- Repeat steps 4 and 5 until the film is not smeared.
- Visually check that the film is not smeared.



---

## Checking the Total Number of Pages Fed Through the Printer

You can check the total number of pages fed through the printer.

### Checking the Total Number of Pages Fed Through the Printer - Printer Buttons

The information is printed together with the nozzle check pattern.

- Load A4-size plain paper in the printer.
- Press the  button to turn off the printer.
- Turn the printer on while holding the  button down, and then release the buttons when the power light flashes.

## Maintaining the Printer

### Related Information

➔ [“Loading Paper in the Paper Cassette” on page 35](#)

## Checking the Total Number of Pages Fed Through the Printer - Windows

1. Access the printer driver window.
2. Click **Printer and Option Information** on the **Maintenance** tab.

### Related Information

➔ [“Accessing the Printer Driver” on page 43](#)

## Checking the Total Number of Pages Fed Through the Printer - Mac OS

1. Select **System Preferences** from the  menu > **Printers & Scanners** (or **Print & Scan**, **Print & Fax**), and then select the printer.
2. Click **Options & Supplies** > **Utility** > **Open Printer Utility**.
3. Click **Printer and Option Information**.

# Network Service and Software Information

This section introduces the network services and software products available for your printer from the Epson website or the supplied software disc.

## Application for Configuring Printer Operations (Web Config)

Web Config is an application that runs in a web browser, such as Internet Explorer and Safari, on a computer or smart device. You can confirm the printer status or change the network service and printer settings. To use the Web Config, connect the printer and the computer or device to the same network.

The following browsers are supported.

OS	Browser
Windows XP SP3 or later	Microsoft Edge, Internet Explorer 8 or later, Firefox*, Chrome*
Mac OS X v10.6.8 or later	Safari*, Firefox*, Chrome*
iOS*	Safari*
Android 2.3 or later	Default browser
Chrome OS*	Default browser

\* Use the latest version.

## Running Web Config on a Web Browser

1. Check the printer's IP address.

Press the  button to print the network connection report, and then check the printer's IP address.

2. Launch a Web browser from a computer or smart device, and then enter the printer's IP address.

Format:

IPv4: http://the printer's IP address/

Examples:

IPv4: http://192.168.100.201/

**Note:**

*Using the smart device, you can also run Web Config from the maintenance screen of Epson iPrint.*

### Related Information

➔ [“Using Epson iPrint” on page 67](#)

## Running Web Config on Windows

When connecting a computer to the printer using WSD, follow the steps below to run Web Config.

1. Open the printer list on the computer.
  - Windows 10/Windows Server 2016  
Click on the start button, and then select **Windows System > Control Panel > View devices and printers in Hardware and Sound**.
  - Windows 8.1/Windows 8/Windows Server 2012 R2/Windows Server 2012  
Select **Desktop > Settings > Control Panel > View devices and printers in Hardware and Sound (or Hardware)**.
  - Windows 7/Windows Server 2008 R2  
Click the start button, and select **Control Panel > View devices and printers in Hardware and Sound**.
  - Windows Vista/Windows Server 2008  
Click the start button, and select **Control Panel > Printers in Hardware and Sound**.
2. Right-click on your printer and select **Properties**.
3. Select the **Web Service** tab and click the URL.

## Running Web Config on Mac OS

1. Select **System Preferences** from the  menu > **Printers & Scanners** (or **Print & Scan, Print & Fax**), and then select the printer.
2. Click **Options & Supplies > Show Printer Webpage**.

---

## Application for Printing Web Pages (E-Web Print)

E-Web Print is an application that allows you to easily print web pages with various layouts. See the application's help for details. You can access the help from the **E-Web Print** menu on the **E-Web Print** tool bar.

### Note:

- Windows Server operating systems are not supported.*
- Mac OS is not supported.*
- Check for supported browsers and the latest version from the download site.*

### Starting

When you install E-Web Print, it is displayed in your browser. Click **Print** or **Clip**.

### Related Information

- ➔ [“Installing the Latest Applications” on page 93](#)

---

## Software Update Tools (EPSON Software Updater)

EPSON Software Updater is an application that checks for new or updated software on the internet and installs it. You can also update the printer's firmware and manual.

**Note:**

*Windows Server operating systems are not supported.*

### Installing Method

Download EPSON Software Updater from the Epson website.

If you are using a Windows computer and cannot to download it from the website, you can install it from the supplied software disc.

<http://www.epson.com>

### Starting on Windows

 Windows 10

Click the start button, and then select **Epson Software > EPSON Software Updater**.

 Windows 8.1/Windows 8

Enter the application name in the search charm, and then select the displayed icon.

 Windows 7/Windows Vista/Windows XP

Click the start button, and then select **All Programs** or **Programs > Epson Software > EPSON Software Updater**.

**Note:**

*You can also start EPSON Software Updater by clicking the printer icon on the task bar on the desktop, and then selecting **Software Update**.*

### Starting on Mac OS

Select **Go > Applications > Epson Software > EPSON Software Updater**.

---

## Installing the Latest Applications

**Note:**

*When reinstalling an application, you need to uninstall it first.*

1. Make sure the printer and the computer are available for communication, and the printer is connected to the Internet.

## Network Service and Software Information

2. Start EPSON Software Updater.

The screenshot is an example on Windows.

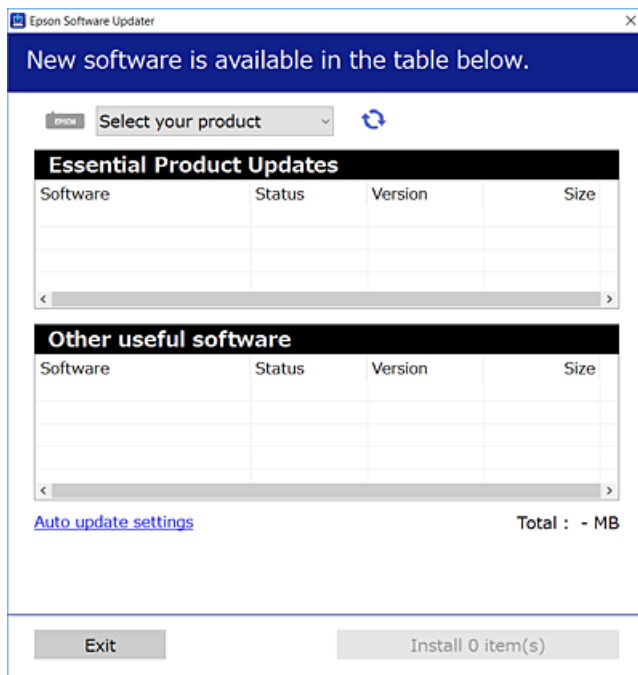

3. For Windows, select your printer, and then click  to check for the latest available applications.
4. Select the items you want to install or update, and then click the install button.



**Important:**

*Do not turn off or unplug the printer until the update is complete; otherwise, the printer may malfunction.*

**Note:**

- You can download the latest applications from the Epson website.  
<http://www.epson.com>
- If you use Windows Server operating systems, you cannot use EPSON Software Updater. Download the latest applications from the Epson website.

### Related Information

- ➔ [“Software Update Tools \(EPSON Software Updater\)” on page 93](#)
- ➔ [“Uninstalling Applications” on page 95](#)

---

## Updating Applications and Firmware

You may be able to clear certain problems and improve or add functions by updating the applications and the firmware. Make sure you use the latest version of the applications and firmware.

1. Make sure that the printer and the computer are connected, and the computer is connected to the internet.

## Network Service and Software Information

2. Start EPSON Software Updater, and update the applications or the firmware.

**Important:**

*Do not turn off the computer or the printer until the update is complete; otherwise, the printer may malfunction.*

**Note:**

*If you cannot find the application you want to update in the list, you cannot update using the EPSON Software Updater. Check for the latest versions of the applications from your local Epson website.*

<http://www.epson.com>

---

## Uninstalling Applications

Log in to your computer as an administrator. Enter the administrator password if the computer prompts you.



### Uninstalling Applications - Windows

1. Press the  button to turn off the printer.
2. Quit all running applications.
3. Open **Control Panel**:
  - Windows 10/Windows Server 2016  
Click on the start button, and then select **Windows System > Control Panel**.
  - Windows 8.1/Windows 8/Windows Server 2012 R2/Windows Server 2012  
Select **Desktop > Settings > Control Panel**.
  - Windows 7/Windows Vista/Windows XP/Windows Server 2008 R2/Windows Server 2008/Windows Server 2003 R2/Windows Server 2003  
Click the start button and select **Control Panel**.
4. Open **Uninstall a program** (or **Add or Remove Programs**):
  - Windows 10/Windows 8.1/Windows 8/Windows 7/Windows Vista/Windows Server 2016/Windows Server 2012 R2/Windows Server 2012/Windows Server 2008 R2/Windows Server 2008  
Select **Uninstall a program** in **Programs**.
  - Windows XP/Windows Server 2003 R2/Windows Server 2003  
Click **Add or Remove Programs**.
5. Select the application you want to uninstall.  
You cannot uninstall the printer driver if there is any print jobs. Delete or wait to be printed the jobs before uninstalling.

## Network Service and Software Information

- Uninstall the applications:
    - Windows 10/Windows 8.1/Windows 8/Windows 7/Windows Vista/Windows Server 2016/Windows Server 2012 R2/Windows Server 2012/Windows Server 2008 R2/Windows Server 2008  
Click **Uninstall/Change** or **Uninstall**.
    - Windows XP/Windows Server 2003 R2/Windows Server 2003  
Click **Change/Remove** or **Remove**.
- Note:**  
If the **User Account Control** window is displayed, click **Continue**.
- Follow the on-screen instructions.

## Uninstalling Applications - Mac OS

- Download the Uninstaller using EPSON Software Updater.  
Once you have downloaded the Uninstaller, you do not need to download it again each time you uninstall the application.
- Press the  button to turn off the printer.
- To uninstall the printer driver, select **System Preferences** from the  menu > **Printers & Scanners** (or **Print & Scan, Print & Fax**), and then remove the printer from the enabled printers list.
- Quit all running applications.
- Select **Go > Applications > Epson Software > Uninstaller**.
- Select the application you want to uninstall, and then click **Uninstall**.

**Important:**

The Uninstaller removes all drivers for Epson inkjet printers on the computer. If you use multiple Epson inkjet printers and you only want to delete some drivers, delete all of them first, and then install the necessary printer driver again.

**Note:**

If you cannot find the application you want to uninstall in the application list, you cannot uninstall using the Uninstaller. In this situation, select **Go > Applications > Epson Software**, select the application you want to uninstall, and then drag it to the trash icon.

### Related Information

➔ [“Software Update Tools \(EPSON Software Updater\)” on page 93](#)

---

## Printing Using a Network Service

By using Epson Connect service available on the Internet, you can print from your smartphone, tablet PC, or laptop, anytime and practically anywhere. To use this service, you need to register the user and the printer in Epson Connect.



## Network Service and Software Information

The features available on the Internet are as follows.

Email Print

When you send an email with attachments such as documents or images to an email address assigned to the printer, you can print that email and the attachments from remote locations such as your home or office printer.

Epson iPrint

This Application is for iOS and Android, and allows you to print from a smart phone or tablet. You can print documents, images, and websites by sending them directly to a printer on the same wireless LAN.

Remote Print Driver

This is a shared driver supported by Remote Print Driver. When printing using a printer in a remote location, you can print by changing the printer on the usual applications window.

See the Epson Connect portal website for details.

<https://www.epsonconnect.com/>

<http://www.epsonconnect.eu> (Europe only)

# Solving Problems

## Checking the Printer Status

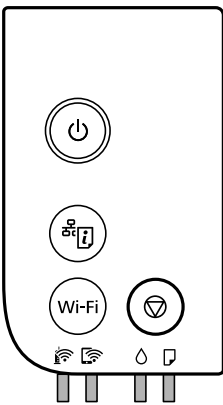

### Lights and Printer Status

Lights on the control panel indicate the status of the printer.



#### Normal Status

: On



Light	Status
	The printer is connected to a wireless (Wi-Fi) network.
	The printer is connected to a network in Wi-Fi Direct (Simple AP) mode.

#### Error Status













When an error occurs, the light turns on or flashes. Details of the error are displayed on the computer screen.

: On



: Flashing

Light	Status	Solutions
 	Wi-Fi connection error has occurred.	Press the Wi-Fi button to clear the error and try again.

## Solving Problems

Light	Status	Solutions
	Initial ink charging may not be complete.	See the <i>Start Here</i> poster to complete initial ink charging.  When ink is low, initial ink charging may not be completed.
	It is time to reset the ink level.	Refill the ink tank to the upper line, and then reset the ink level.
	There is not enough ink remaining to perform cleaning.	Refill the ink tank to the upper line, and then reset the ink level before cleaning.
	It is nearly time to reset the ink level.	You can print until it is time to reset the ink level. Prepare a new ink bottle.
	The maintenance box is nearing the end of its service life.	When a message saying that you can continue printing is displayed on the computer, press the  button to continue printing. The lights stop flashing for the time being, however, they will continue to flash at regular intervals until the maintenance box is replaced.
	No paper is loaded or more than one sheet has been fed at a time.	Load paper and press the  button.
	The paper size loaded does not match the print setting.	Load the correct size paper.
	There is a problem with the printer driver.	Press the  button to cancel the print job.
	Flashing slowly (at 1.25 second intervals) A paper jam has occurred.	Remove the paper and press the  button.
	Flashing fast (at 0.5 second intervals) Paper remains inside the printer.	Load A4 size paper in the rear paper feed slot, and then press the  button to remove the paper inside. Load paper in the portrait direction.
	<ul style="list-style-type: none"> <li><input type="checkbox"/> The printer was not turned off correctly.*</li> <li><input type="checkbox"/> Because the printer was turned off while operating, the nozzles may have dried and clogged.</li> </ul> <p>* The power was turned off with a power strip or breaker, the plug was pulled out of the outlet, or an electrical failure occurred.</p>	<ul style="list-style-type: none"> <li><input type="checkbox"/> After clearing the error by pressing the  button, we recommend performing a nozzle check. Cancel any pending print jobs.</li> <li><input type="checkbox"/> To turn off the printer, make sure you press the  button.</li> </ul>
	Flashing simultaneously The printer cover is open.	Close the printer cover until it clicks.
	Flashing simultaneously The output switch lever is lowered.	Raise the output switch lever.
	Flashing simultaneously The output switch lever is raised.	Open the paper cassette cover, and then lower the output switch lever.

## Solving Problems

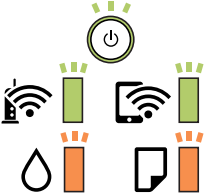
Light	Status	Solutions
	Flashing alternately A maintenance box is at the end of its service life.	The maintenance box needs to be replaced.
	Flashing alternately The maintenance box cannot be recognized.	You cannot install a maintenance box that has already been used in another printer. Install a new maintenance box.
	Flashing alternately The maintenance box is not installed.	Install the maintenance box again.
	Flashing alternately There is not enough free space left in the maintenance box to perform cleaning.	Replace the maintenance box before cleaning. You may still be able to print even if you cannot perform cleaning.
	The printer has started in recovery mode because the firmware update failed.	Follow the steps below to try to update the firmware again. <ol style="list-style-type: none"> <li>1. Connect the computer and the printer with a USB cable. (During recovery mode, you cannot update the firmware over a network connection.)</li> <li>2. Visit your local Epson website for further instructions.</li> </ol>
	A printer error has occurred.	Open the printer cover and remove any paper inside the printer. Turn the power off and on again.  If the error continues to occur after turning the power off and on again, contact Epson support.

## Related Information

- ➔ [“Removing Jammed Paper” on page 101](#)
- ➔ [“Contacting Epson Support” on page 133](#)
- ➔ [“Installing the Latest Applications” on page 93](#)

## Checking the Printer Status - Windows

1. Access the printer driver window.
2. Click **EPSON Status Monitor 3** on the **Maintenance** tab.

**Note:**

- You can also check the printer status by double-clicking the printer icon on the taskbar. If the printer icon is not added to the taskbar, click **Monitoring Preferences** on the **Maintenance** tab, and then select **Register the shortcut icon to the taskbar**.
- If **EPSON Status Monitor 3** is disabled, click **Extended Settings** on the **Maintenance** tab, and then select **Enable EPSON Status Monitor 3**.

## Related Information

- ➔ [“Accessing the Printer Driver” on page 43](#)

## Checking the Printer Status - Mac OS

1. Select **System Preferences** from the  menu > **Printers & Scanners** (or **Print & Scan**, **Print & Fax**), and then select the printer.
2. Click **Options & Supplies** > **Utility** > **Open Printer Utility**.
3. Click **EPSON Status Monitor**.

You can check the printer status, ink levels, and error status.

---

## Checking the Software Status

You may be able to clear the problem by updating the software to the latest version. To check the software status, use the software update tool.

### Related Information

- ➔ [“Software Update Tools \(EPSON Software Updater\)” on page 93](#)
- ➔ [“Installing the Latest Applications” on page 93](#)

---

## Removing Jammed Paper

Check the error displayed on the control panel and follow the instructions to remove the jammed paper including any torn pieces. Next, clear the error.



### **Important:**

- Remove the jammed paper carefully. Removing the paper vigorously may cause damage to the printer.*
- When removing jammed paper, avoid tilting the printer, placing it vertically, or turning it upside down; otherwise ink may leak.*

## Removing Jammed Paper from the Front Cover



### **Caution:**

*Never touch the buttons on the control panel while your hand is inside the printer. If the printer starts operating, it could cause an injury. Be careful not to touch the protruding parts to avoid injury.*

## Solving Problems

1. Open the front cover.

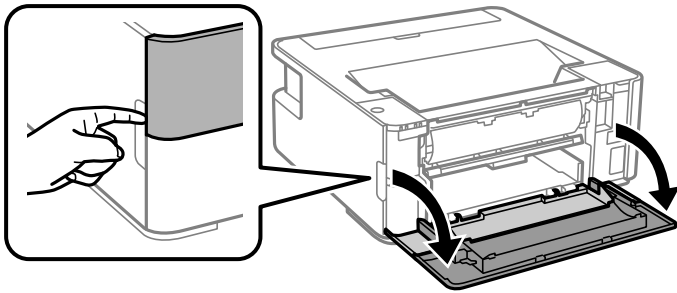

2. Lower the output switch lever.

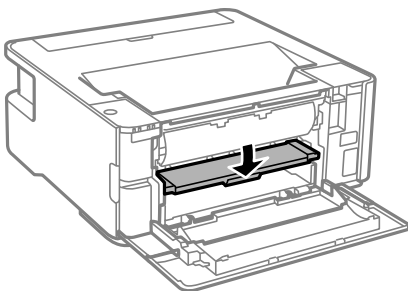

3. Remove the jammed paper.

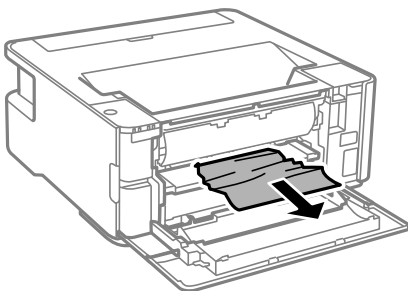

**Important:**

*Do not touch the parts inside the printer. Doing so may cause a malfunction.*

4. Raise the output switch lever.
5. Close the front cover.

## Removing Jammed Paper from the Rear Paper Feed Slot

Remove the jammed paper.

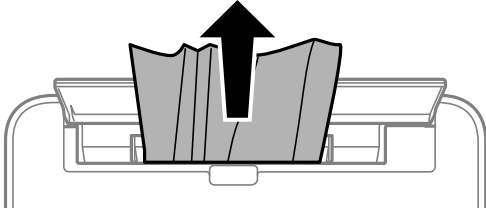

## Removing Jammed Paper from Inside the Printer

**⚠ Caution:**

*Never touch the buttons on the control panel while your hand is inside the printer. If the printer starts operating, it could cause an injury. Be careful not to touch the protruding parts to avoid injury.*

1. Open the printer cover.

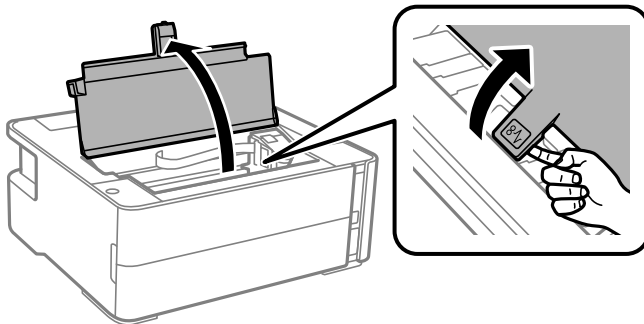

2. Remove the jammed paper.

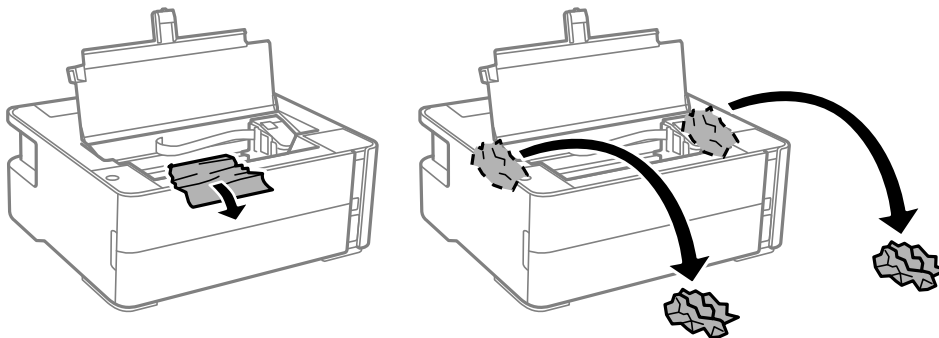

## Solving Problems

**!** *Important:*

*Do not touch the white flat cable, translucent film, and ink tubes inside the printer. Doing so may cause a malfunction. If you touch the translucent film, make sure you clean it.*

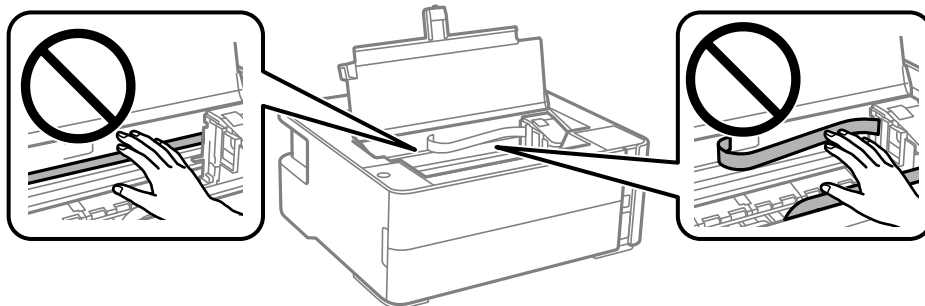

3. Close the printer cover until it clicks.

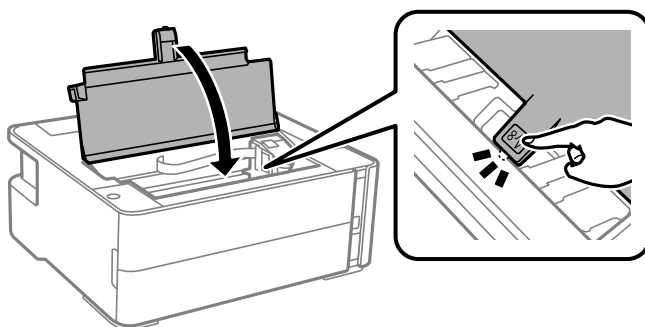

## Removing Jammed Paper from Rear Cover

1. Remove the rear cover.

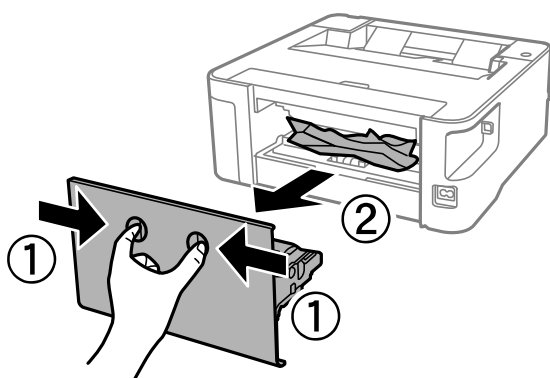



## Solving Problems

2. Remove the jammed paper.

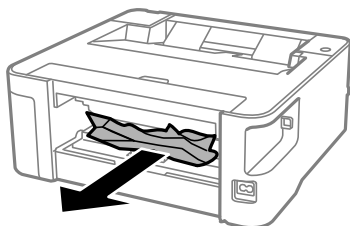

3. Remove jammed paper from the rear cover.

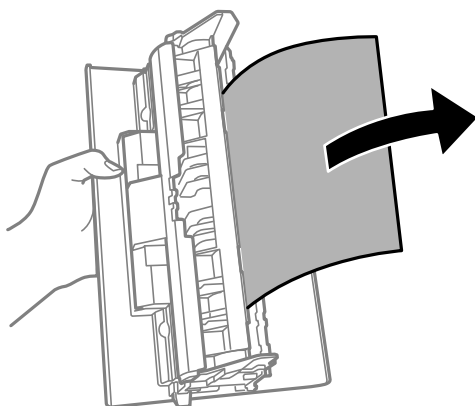

4. Insert the rear cover in the printer.

---

## Paper Does Not Feed Correctly

Check the following points, and then take the appropriate actions to solve the problem.

- Place the printer on a flat surface and operate in the recommended environmental conditions.
- Use paper supported by this printer.
- Follow the paper handling precautions.
- Do not load more than the maximum number of sheets specified for the paper.
- Clean the roller inside the printer.

### Related Information

- ➔ [“Environmental Specifications” on page 127](#)
- ➔ [“Paper Handling Precautions” on page 34](#)
- ➔ [“Available Paper and Capacities” on page 32](#)
- ➔ [“List of Paper Type” on page 40](#)

## Paper Jams

Load paper in the correct direction, and slide the edge guides against the edges of the paper.

**Related Information**

- ➔ [“Removing Jammed Paper” on page 101](#)
- ➔ [“Loading Paper in the Paper Cassette” on page 35](#)

## Paper Feeds at a Slant

Load paper in the correct direction, and slide the edge guides against the edges of the paper.

**Related Information**

- ➔ [“Loading Paper in the Paper Cassette” on page 35](#)

## Ejected Paper Falls from the Output Tray

Open the feeder guard to stop ejected paper falling from the output tray.

## Paper is Ejected During Printing

When you load letterhead paper (paper on which information such as the sender's name or corporation name are pre-printed in the header), select **Letterhead** as the paper type setting.



---

# Power and Control Panel Problems

## Power Does Not Turn On

- Make sure the power cord is securely plugged in.
- Hold down the  button for a little longer.

## Power Does Not Turn Off

Hold down the  button for a little longer. If you still cannot turn off the printer, unplug the power cord. To prevent the print head from drying out, turn the printer back on and turn it off by pressing the  button.

## Power Turns Off Automatically

- Windows
  - Click **Printer and Option Information** on the printer driver's **Maintenance** tab.
  - Disable the **Power Off If Inactive** and **Power Off If Disconnected** settings.
  - Disable the **Power Off Timer** setting.

## Solving Problems

### ❑ Mac OS

Select **System Preferences** from the  menu > **Printers & Scanners** (or **Print & Scan, Print & Fax**), and then select the printer. Click **Options & Supplies > Utility > Open Printer Utility**, and then click **Printer Settings**.

❑ Disable the **Power Off If Inactive** and **Power Off If Disconnected** settings.

❑ Disable the **Power Off Timer** setting.

#### **Note:**

Your product may have the **Power Off Timer** feature or **Power Off If Inactive** and **Power Off If Disconnected** features depending on the location of purchase.

## Cannot Print from a Computer

### Checking the Connection (USB)

- ❑ Connect the USB cable securely to the printer and the computer.
- ❑ If you are using a USB hub, try to connect the printer directly to the computer.
- ❑ If the USB cable cannot be recognized, change the port, or change the USB cable.
- ❑ If the printer cannot print using a USB connection, try the following.

Disconnect the USB cable from the computer. Right-click on the printer icon displayed on the computer, and then select **Remove Device**. Next, connect the USB cable to the computer and try a test print.

Re-set the USB connection by following the steps in this manual for changing the connection method to a computer. See the related information link below for details.

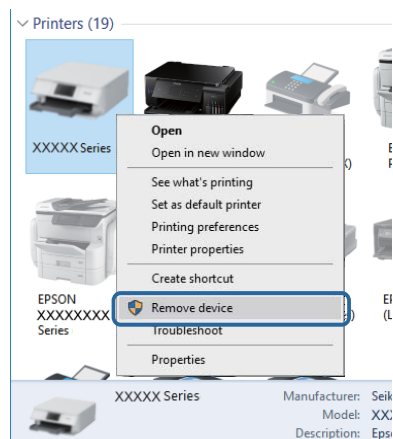

#### Related Information

➔ [“Changing the Connection Method to a Computer” on page 30](#)

### Checking the Connection (Network)

- ❑ When you have changed your wireless router or provider, try making network settings for the printer again. Connect the computer or smart device to the same SSID as the printer.

## Solving Problems

- ❑ Turn off the devices you want to connect to the network. Wait for about 10 seconds, and then turn on the devices in the following order; wireless router, computer or smart device, and then printer. Move the printer and computer or smart device closer to the wireless router to help with radio wave communication, and then try to make network settings again.
- ❑ Print the network connection report. See the related information link below for details. If the report shows that the network connection failed, check the network connection report and then follow the printed solutions.
- ❑ If the IP address assigned to the printer is 169.254.XXX.XXX, and the subnet mask is 255.255.0.0, the IP address may not be assigned correctly. Restart the wireless router or reset the network settings for the printer. If this does not solve the problem, see the documentation for the wireless router.
- ❑ Try accessing any website from your computer to make sure that your computer's network settings are correct. If you cannot access any website, there is a problem on the computer. Check the network connection of the computer.

### Related Information

- ➔ [“Connecting to a Computer” on page 18](#)
- ➔ [“Printing a Network Status Sheet” on page 29](#)

## Checking the Software and Data

- ❑ Make sure that a genuine Epson printer driver is installed. If a genuine Epson printer driver is not installed, the available functions are limited. We recommend using a genuine Epson printer driver. See the related information link below for details.
- ❑ If you are printing a large data size image, the computer may run out of memory. Print the image at a lower resolution or a smaller size.

### Related Information

- ➔ [“Checking for Genuine Epson Printer Drivers” on page 108](#)
- ➔ [“Installing the Latest Applications” on page 93](#)

## Checking for Genuine Epson Printer Drivers

You can check if a genuine Epson printer driver is installed on your computer by using one of the following methods.

### Windows

Select **Control Panel > View devices and printers (Printers, Printers and Faxes)**, and then do the following to open the print server properties window.

- ❑ Windows 10/Windows 8.1/Windows 8/Windows 7/Windows Server 2016/Windows Server 2012 R2/Windows Server 2012/Windows Server 2008 R2  
Click the printer icon, and then click **Print server properties** at the top of the window.
- ❑ Windows Vista/Windows Server 2008  
Right-click on the **Printers** folder, and then click **Run as administrator > Server Properties**.
- ❑ Windows XP/Windows Server 2003 R2/Windows Server 2003  
From the **File** menu, select **Server Properties**.

## Solving Problems

Click the **Driver** tab. If your printer name is displayed in the list, a genuine Epson printer driver is installed on your computer.

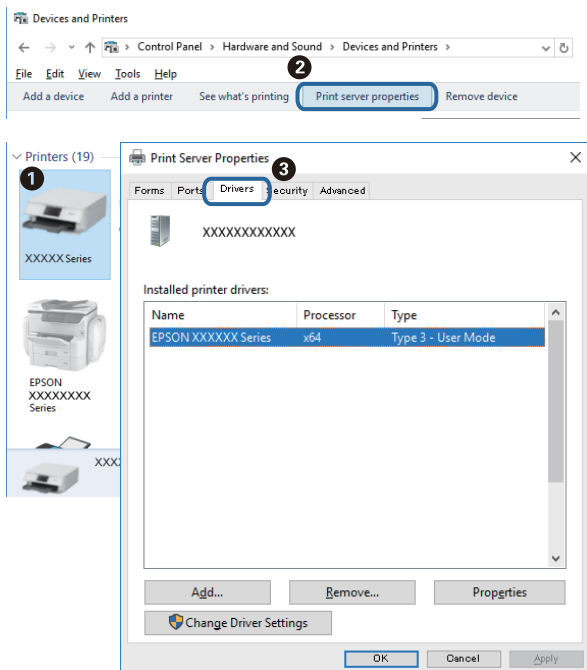

## Mac OS

Select **System Preferences** from the  menu > **Printers & Scanners** (or **Print & Scan, Print & Fax**), and then select the printer. Click **Options & Supplies**, and if the **Options** tab and **Utility** tab are displayed on the window, a genuine Epson printer driver is installed on your computer.



## Related Information

➔ [“Installing the Latest Applications” on page 93](#)

## Solving Problems

### Checking the Printer Status from the Computer (Windows)

Click **Print Queue** on the printer driver's **Maintenance** tab, and then check the following.

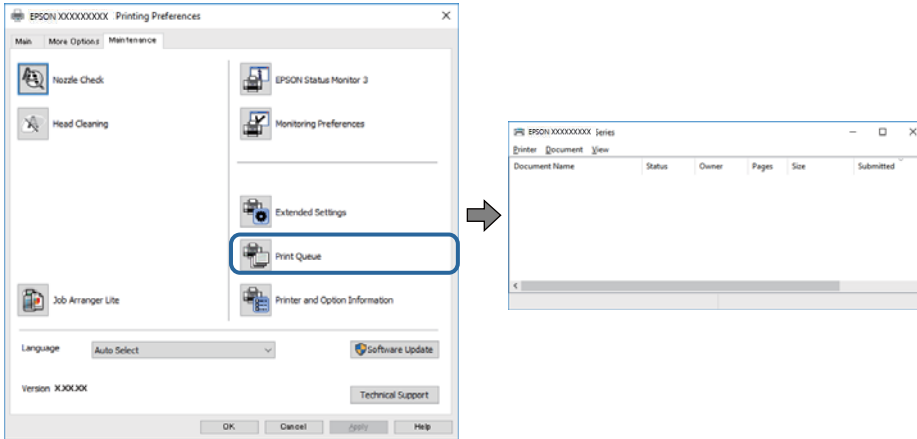

- Check if there are any paused print jobs.  
If unnecessary data remains, select **Cancel all documents** from the **Printer** menu.
- Make sure the printer is not offline or pending.  
If the printer is offline or pending, clear the offline or pending setting from the **Printer** menu.

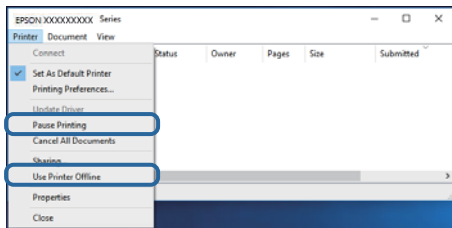

- Make sure the printer is selected as the default printer from the **Printer** menu (there should be a check mark on the menu item).  
If the printer is not selected as the default printer, set it as the default printer. If there are multiple icons in **Control Panel > View devices and printers (Printers, Printers and Faxes)**, see the following to select the icon.  
Example)  
USB connection: EPSON XXXX Series  
Network connection: EPSON XXXX Series (network)  
If you install the printer driver multiple times, copies of printer driver may be created. If copies such as "EPSON XXXX Series (copy 1)" are created, right-click the copied driver icon, and then click **Remove Device**.
- Make sure the printer port is selected correctly in **Property > Port** from the **Printer** menu as follows.  
Select "USBXXX" for a USB connection, or "EpsonNet Print Port" for a network connection.

### Checking the Printer Status from the Computer (Mac OS)

Make sure the printer status is not **Pause**.

Select **System Preferences** from the  menu > **Printers & Scanners** (or **Print & Scan, Print & Fax**), and then double-click the printer. If the printer is paused, click **Resume** (or **Resume Printer**).

## When You Cannot Make Network Settings

- ❑ Turn off the devices you want to connect to the network. Wait for about 10 seconds, and then turn on the devices in the following order; wireless router, computer or smart device, and then printer. Move the printer and computer or smart device closer to the wireless router to help with radio wave communication, and then try to make network settings again.
- ❑ Press the  button to print the network connection report. Check it and then follow the printed solutions.

### Related Information

- ➔ [“Printing a Network Status Sheet” on page 29](#)
- ➔ [“Checking the SSID Connected to the Printer” on page 114](#)
- ➔ [“Checking the SSID for the Computer” on page 115](#)

## Cannot Connect from Devices Even Though Network Settings are No Problems

If you cannot connect from the computer or smart device to the printer even though the network connection report does not show any problems, see the following.

- ❑ When you are using multiple wireless routers at the same time, you may not be able to use the printer from the computer or smart device depending on the settings of the wireless routers. Connect the computer or smart device to the same wireless router as the printer.  
Disable the tethering function on the smart device if it is enabled.

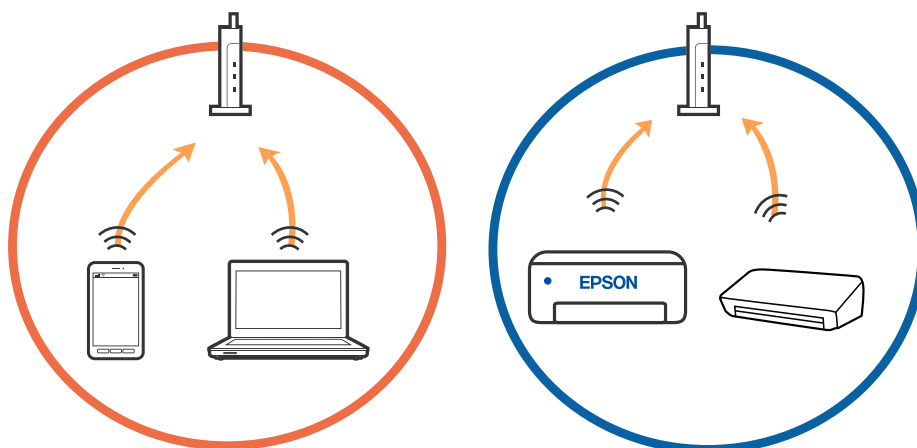

### Solving Problems

- ❑ You may not be able to connect to the wireless router when the wireless router has multiple SSIDs and devices are connected to different SSIDs on the same wireless router. Connect the computer or smart device to the same SSID as the printer.

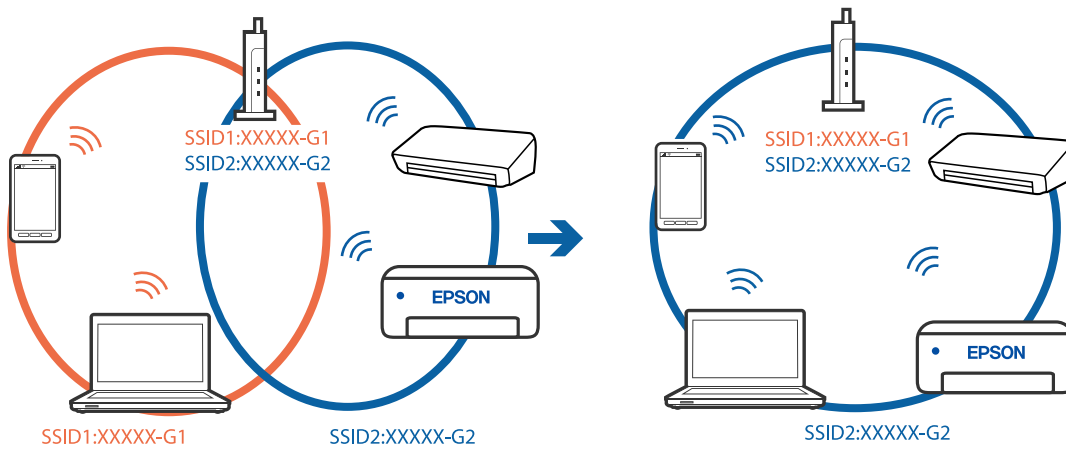

- ❑ A wireless router that is compliant with both IEEE802.11a and IEEE802.11g has SSIDs of 2.4 GHz and 5 GHz. If you connect the computer or smart device to a 5 GHz SSID, you cannot connect to the printer because the printer only supports communication over 2.4 GHz. Connect the computer or smart device to the same SSID as the printer.

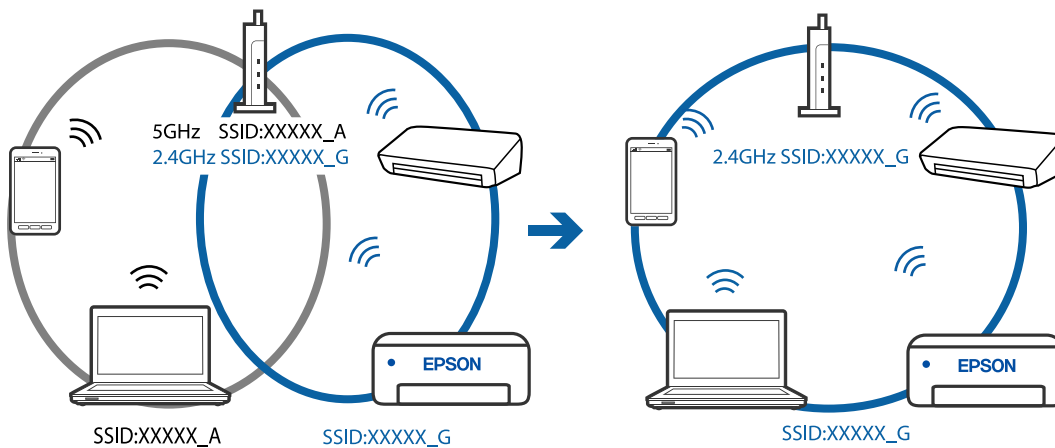

- ❑ Most wireless routers have a privacy separator feature that blocks communication between connected devices. If you cannot communicate between the printer and the computer or smart device even if they are connected to the same network, disable the privacy separator on the wireless router. See the manual provided with the wireless router for details.

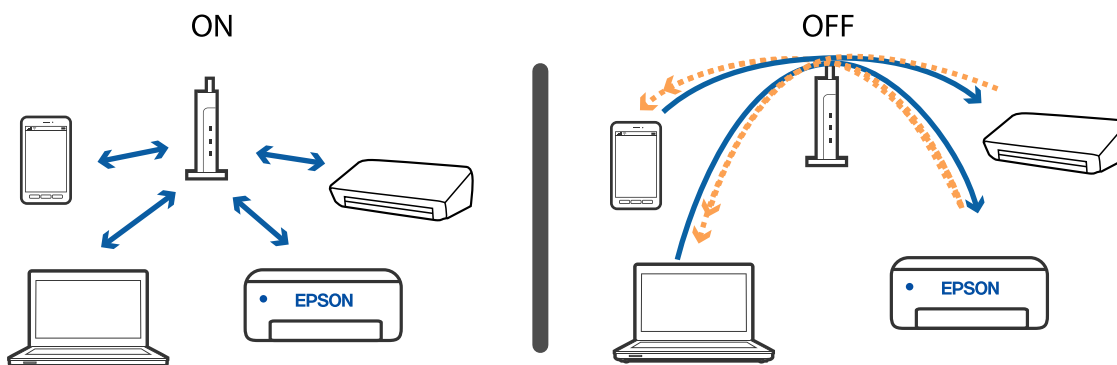



## Solving Problems

### Related Information

- ➔ [“Checking the SSID Connected to the Printer” on page 114](#)
- ➔ [“Checking the SSID for the Computer” on page 115](#)

## When You Cannot Connect Using Wi-Fi Direct (Simple AP) Connection

If the maximum number of devices have already been connected, you cannot connect any more devices. See the following and try to re-connect.

### Check how many devices are connected

Check how many devices are connected to the printer. If the number of connected devices has not exceeded the maximum, a connection error may have occurred. Move the printer and computer or smart device closer to the wireless router to help with radio wave communication, check that the SSID and password are correct, and then try to make network settings again.

- Network status sheet

```

<Wi-Fi Direct>
Wi-Fi Direct Mode           On
Communication Mode         Simple AP
Operation Mode              IEEE802.11g/n
Communication Speed         Auto
SSID                        DIRECT-XXXXXXXXXX
Password                    XXXXXXXX
Channel                      11
Security Level              WPA2-PSK(AES)
Link Status                  Unknown
Connected Devices           2 (Max 4)
Client MAC List             9C:5C:F9:38:C3:74
                             20:02:AF:C1:92:6B
    
```

## Solving Problems

### ❑ Product status screen for Web Config

Launch a web browser from the connected device, and then enter the IP address for Wi-Fi Direct (Simple AP) to open Web Config. Tap **Product Status** > **Wi-Fi Direct** and check the Wi-Fi Direct status.



### Disconnect unnecessary devices

If the maximum number of devices have already been connected to the printer, disconnect the unnecessary devices and try to connect the new device.

Delete the SSID for Wi-Fi Direct on the Wi-Fi screen for the device that you do not need to connect to the printer.

## Checking the SSID Connected to the Printer

You can check the SSID by printing a network connection report, network status sheet, or on Web Config.

## Checking the SSID for the Computer

### Windows

Click  in the task tray on the desktop. Check the name of the connected SSID from the list displayed.

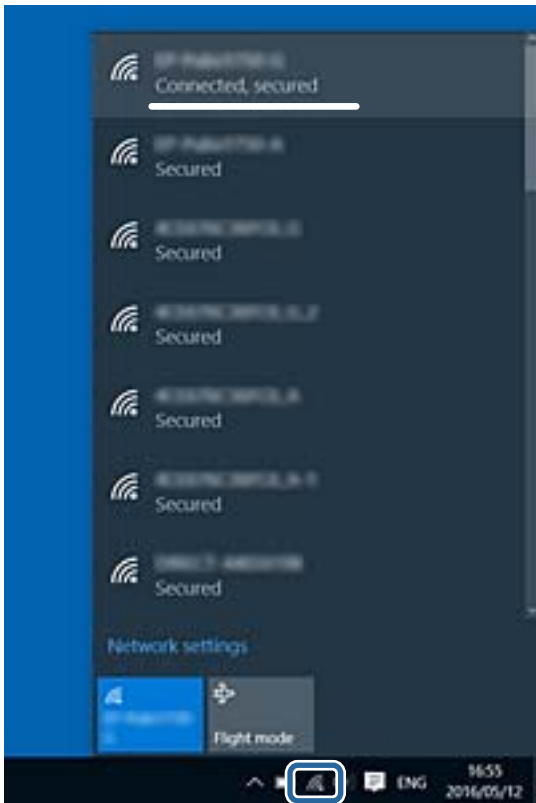

### Mac OS

Click the Wi-Fi icon at the top of the computer screen. A list of SSIDs is displayed and the connected SSID is indicated with a check mark.



## Solving Problems

### Ethernet Connection Becomes Unstable

When you connect the printer by Ethernet using devices that support IEEE802.3az (Energy Efficient Ethernet), the following problems may occur depending on the hub or router that you are using.

- Connection becomes unstable, the printer is connected and disconnected again and again.
- Cannot connect to the printer.
- The communication speed becomes slow.

Follow the steps below to disable IEEE802.3az for the printer and then connect.

1. Remove the Ethernet cable connected to the computer and the printer.
  2. When IEEE802.3az for the computer is enabled, disable it.  
See the documentation provided with the computer for details.
  3. Connect the computer and the printer with an Ethernet cable directly.
  4. On the printer, print a network connection report.
  5. Check the printer's IP address on the network connection report.
  6. On the computer, access Web Config.  
Launch a Web browser, and then enter the printer's IP address.
  7. Select **Advanced Settings** from the list at the top right of the window.
  8. Select **Network Settings > Wired LAN**.
  9. Select **OFF** for **IEEE 802.3az**.
  10. Click **Next**.
  11. Click **OK**.
  12. Remove the Ethernet cable connected to the computer and the printer.
  13. If you disabled IEEE802.3az for the computer in step 2, enable it.
  14. Connect the Ethernet cables that you removed in step 1 to the computer and the printer.
- If the problem still occurs, devices other than the printer may be causing the problem.

#### Related Information

➔ [“Application for Configuring Printer Operations \(Web Config\)” on page 91](#)

---

## Printout Problems

### Printout is Scuffed or Color is Missing

- ❑ If you have not used the printer for a long time, the print head nozzles may be clogged and ink drops may not be discharged. Perform a nozzle check, and then clean the print head if any of the print head nozzles are clogged.
- ❑ If you printed when the ink level was too low to be seen in the ink tank window, refill the ink tank to the upper line and then use the **Power Cleaning** utility to replace the ink inside the ink tubes. After you use the utility, perform a nozzle check to see if print quality has improved.

#### Related Information

- ➔ [“Check if Nozzles are Clogged \(Nozzle Check\)”](#) on page 79
- ➔ [“Refilling the Ink Tank”](#) on page 73
- ➔ [“Power Cleaning the Print Head \(Power Cleaning\)”](#) on page 83

### Banding or Unexpected Colors Appear



The print head nozzles may be clogged. Perform a nozzle check to check if the print head nozzles are clogged. Clean the print head if any of the print head nozzles are clogged.

#### Related Information

- ➔ [“Check if Nozzles are Clogged \(Nozzle Check\)”](#) on page 79

### Colored Banding Appears at Intervals of Approximately 3.3 cm

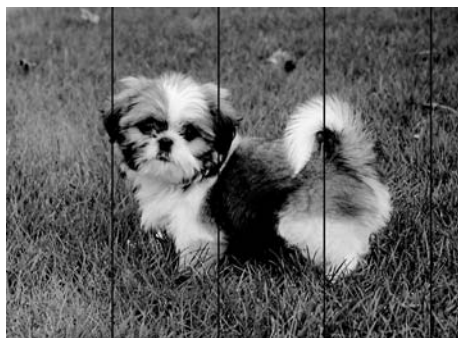

## Solving Problems

- Select the appropriate paper type setting for the type of paper loaded in the printer.
- Align the print head from a computer.
- When printing on plain paper, print using a higher quality setting.

### Related Information

- ➔ [“List of Paper Type” on page 40](#)
- ➔ [“Aligning the Print Head” on page 85](#)

## Vertical Banding or Misalignment

enthalten alle  
Aufdruck. W  
5008 "Regel

- Align the print head.
- If print quality does not improve even after aligning the print head, print using a higher quality setting.

### Related Information

- ➔ [“Aligning the Print Head” on page 85](#)

## Print Quality is Poor

Check the following if the print quality is poor due to blurry prints, banding, missing colors, faded colors, and misalignment in the prints.

### Checking the printer

- Make sure the initial ink charging is complete.
- Refill the ink tank if the ink level is below the lower line.
- Perform a nozzle check, and then clean the print head if any of the print head nozzles are clogged.
- Align the print head.

### Checking the paper

- Use paper supported by this printer.
- Do not print on paper that is damp, damaged, or too old.
- If the paper is curled or the envelope is puffed up, flatten it.
- Do not stack the paper immediately after printing.
- Dry the printouts completely before filing or displaying them. When drying the printouts, avoid direct sun light, do not use a dryer, and do not touch the printed side of paper.

## Solving Problems

- When printing images or photos, Epson recommends using genuine Epson paper rather than plain paper. Print on the printable side of the genuine Epson paper.

### Checking the print settings

- Select the appropriate paper type setting for the type of paper loaded in the printer.
- Print using a higher quality setting.
- During bidirectional (or high speed) printing, the print head prints while moving in both directions, and vertical lines may be misaligned. If print quality does not improve, disable the bidirectional (or high speed) setting. Disabling this setting may slow down printing speed.
  - Windows  
Clear **High Speed** on the printer driver's **More Options** tab.
  - Mac OS  
Select **System Preferences** from the  menu > **Printers & Scanners** (or **Print & Scan, Print & Fax**), and then select the printer. Click **Options & Supplies** > **Options** (or **Driver**). Select **Off** as the **High Speed Printing** setting.

### Checking the ink bottle

- Use ink bottles with the correct part code for this printer.
- Epson recommends using the ink bottle before the date printed on the package.
- Try to use genuine Epson ink bottles. This product is designed to adjust colors based on the use of genuine Epson ink bottles. The use of non-genuine ink bottles may cause print quality to decline.

### Related Information

- ➔ [“Check if Nozzles are Clogged \(Nozzle Check\)” on page 79](#)
- ➔ [“Aligning the Print Head” on page 85](#)
- ➔ [“Available Paper and Capacities” on page 32](#)
- ➔ [“List of Paper Type” on page 40](#)
- ➔ [“Paper Handling Precautions” on page 34](#)

## Paper Is Smearred or Scuffed

- When horizontal banding appears or the top or bottom of the paper is smeared, load paper in the correct direction and slide the edge guides to the edges of the paper.

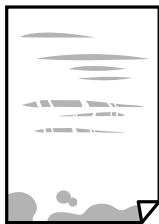

## Solving Problems

- When vertical banding appears or the paper is smeared, clean the paper path.



- Place the paper on a flat surface to check if it is curled. If it is, flatten it.
- When printing on thick paper, the print head is close to the printing surface and the paper may be scuffed. In this case, enable the reduce scuff setting. If you enable this setting, print quality may decline or printing may slow down.

Windows

Click **Extended Settings** on the printer driver's **Maintenance** tab, and then select **Short Grain Paper**.

### Related Information

- ➔ [“Loading Paper in the Paper Cassette” on page 35](#)
- ➔ [“Cleaning the Paper Path” on page 85](#)

## Paper is Smeared During Automatic 2-Sided Printing

When using the automatic 2-sided printing feature and printing high density data such as images and graphs, set the print density to lower and the drying time to longer.

## Printed Photos are Sticky

You may be printing on the wrong side of the photo paper. Make sure you are printing on the printable side.

When printing on the wrong side of the photo paper, you need to clean the paper path.

### Related Information

- ➔ [“Cleaning the Paper Path” on page 85](#)

## The Position, Size, or Margins of the Printout Are Incorrect

- Load paper in the correct direction, and slide the edge guides against the edges of the paper.
- Select the appropriate paper size setting.
- Adjust the margin setting in the application so that it falls within the printable area.

### Related Information

- ➔ [“Loading Paper in the Paper Cassette” on page 35](#)
- ➔ [“Printable Area” on page 124](#)



## Solving Problems

### Printed Characters Are Incorrect or Garbled

- Connect the USB cable securely to the printer and the computer.
- Cancel any paused print jobs.
- Do not put the computer manually into the **Hibernate** mode or the **Sleep** mode while printing. Pages of garbled text may be printed next time you start the computer.
- If you use the printer driver you had previously used, printed characters may be garbled. Make sure that the printer driver you are using is for this printer. Check the printer name on the top of the printer driver window.

### The Printed Image Is Inverted

Clear any mirror image settings in the printer driver or the application.

- Windows
  - Clear **Mirror Image** on the printer driver's **More Options** tab.
- Mac OS
  - Clear **Mirror Image** from the print dialog's **Print Settings** menu.

### Mosaic-Like Patterns in the Prints

When printing images or photos, print using high-resolution data. Images on websites are often low resolution although they look good enough on the display, and so print quality may decline.

### The Printout Problem Could Not be Cleared

If you have tried all of the solutions and have not solved the problem, try uninstalling and then reinstalling the printer driver.

#### Related Information

- ➔ [“Uninstalling Applications” on page 95](#)
- ➔ [“Installing the Latest Applications” on page 93](#)



---

## Other Printing Problems

### Printing Is Too Slow

- Close any unnecessary applications.
- Lower the quality setting. High quality printing slows down the printing speed.

## Solving Problems

- Enable the bidirectional (or high speed) setting. When this setting is enabled, the print head prints while moving in both directions, and the printing speed increases.
  - Windows  
Select **High Speed** on the printer driver's **More Options** tab.
  - Mac OS  
Select **System Preferences** from the  menu > **Printers & Scanners** (or **Print & Scan, Print & Fax**), and then select the printer. Click **Options & Supplies > Options** (or **Driver**). Select **On** as the **High Speed Printing** setting.
- Disable quiet mode. This feature slows down the printing speed.
  - Windows  
Select **Off** as the **Quiet Mode** setting on the printer driver's **Main** tab.
  - Mac OS  
Select **System Preferences** from the  menu > **Printers & Scanners** (or **Print & Scan, Print & Fax**), and then select the printer. Click **Options & Supplies > Options** (or **Driver**). Select **Off** as the **Quiet Mode** setting.

## Printing Slows Down Dramatically During Continuous Printing

Printing slows down to prevent the printer mechanism from overheating and being damaged. However, you can continue printing. To return to normal printing speed, leave the printer idle for at least 30 minutes. Printing speed does not return to normal if the power is off.

---

## Other Problems

### Operation Sounds Are Loud

If operations sounds are too loud, enable **Quiet Mode**. Enabling this feature may reduce printing speed.

- Windows printer driver  
Enable **Quiet Mode** on the **Main** tab.
- Mac OS printer driver  
Select **System Preferences** from the  menu > **Printers & Scanners** (or **Print & Scan, Print & Fax**), and then select the printer. Click **Options & Supplies > Options** (or **Driver**). Select **On** as the **Quiet Mode** setting.

### Application Is Blocked by a Firewall (for Windows Only)

Add the application to the Windows Firewall allowed program in security settings on the **Control Panel**.

### Ink Spilled

- If ink adheres to the area around the tank, wipe it off using a napless, clean cloth or cotton swab.

## Solving Problems

- ❑ If ink spills on the desk or floor, wipe it off immediately. When ink is dried, it will be difficult to remove the smear. To prevent the smear from spreading, blot the ink with a dry cloth, and then wipe it with a moist cloth.
- ❑ If ink gets on your hands, wash them with water and soap.

# Appendix

## Technical Specifications

### Printer Specifications

Print Head Nozzle Placement		Black ink nozzles: 400×2 rows
Weight of Paper*	Plain Paper	64 to 90 g/m <sup>2</sup> (17 to 24lb)
	Envelopes	Envelope #10, DL, C6: 75 to 90 g/m <sup>2</sup> (20 to 24 lb)

\* Even when the paper thickness is within this range, the paper may not feed in the printer or the print quality may decline depending on the paper properties or quality.

### Printable Area

#### Printable Area for Single Sheets

Print quality may decline in the shaded areas due to the printer's mechanism.

	A	3.0 mm (0.12 in.)
	B	3.0 mm (0.12 in.)
	C	46.0 mm (1.81 in.)
	D	44.0 mm (1.73 in.)

#### Printable Area for Envelopes

Print quality may decline in the shaded areas due to the printer's mechanism.

	A	3.0 mm (0.12 in.)
	B	5.0 mm (0.20 in.)
	C	24.0 mm (0.95 in.)
	D	46.0 mm (1.81 in.)

## Appendix

## Interface Specifications

For Computer	Hi-Speed USB
--------------	--------------

## Network Function List

## Network Functions and IPv4/IPv6

Functions			Supported	Remarks
Network Printing	EpsonNet Print (Windows)	IPv4	✓	-
	Standard TCP/IP (Windows)	IPv4, IPv6	✓	-
	WSD Printing (Windows)	IPv4, IPv6	✓	Windows Vista or later
	Bonjour Printing (Mac OS)	IPv4, IPv6	✓	-
	IPP Printing (Windows, Mac OS)	IPv4, IPv6	✓	-
	UPnP Printing	IPv4	-	Information appliance
	PictBridge Printing (Wi-Fi)	IPv4	-	Digital camera
	Epson Connect (Email Print, Remote Print)	IPv4	✓	-
	Google Cloud Print	IPv4, IPv6	✓	-
Network Scanning	Epson Scan 2	IPv4, IPv6	-	-
	Event Manager	IPv4	-	-
	Epson Connect (Scan to Cloud)	IPv4	-	-
	ADF (2-sided scanning)		-	-
Fax	Send a fax	IPv4	-	-
	Receive a fax	IPv4	-	-

## Wi-Fi Specifications

Standards	IEEE802.11b/g/n* <sup>1</sup>
Frequency Range	2.4 GHz
Maximum Radio-Frequency Power Transmitted	20 dBm (EIRP)
Coordination Modes	Infrastructure, Wi-Fi Direct (Simple AP)* <sup>2*3</sup>

## Appendix

Wireless Security <sup>*4</sup>	WEP (64/128bit), WPA2-PSK (AES) <sup>*5</sup>
---------------------------------	---

- \*1 IEEE802.11n is only available for the HT20.
- \*2 Not supported for IEEE 802.11b.
- \*3 Simple AP mode is compatible with a Wi-Fi connection (infrastructure) or an Ethernet connection.
- \*4 Wi-Fi Direct supports WPA2-PSK (AES) only.
- \*5 Complies with WPA2 standards with support for WPA/WPA2 Personal.

## Ethernet Specifications

Standards	IEEE802.3i (10BASE-T) <sup>*1</sup> IEEE802.3u (100BASE-TX) IEEE802.3az (Energy Efficient Ethernet) <sup>*2</sup>
Communication Mode	Auto, 10Mbps Full duplex, 10Mbps Half duplex, 100Mbps Full duplex, 100Mbps Half duplex
Connector	RJ-45

- \*1 Use a category 5e or higher STP (Shielded twisted pair) cable to prevent risk of radio interference.
- \*2 The connected device should comply with IEEE802.3az standards.

## Security Protocol

SSL/TLS	HTTPS Server/Client
---------	---------------------

## Supported Third Party Services

Google Cloud Print
--------------------

## Dimensions

Dimensions	<p>Storage</p> <ul style="list-style-type: none"> <li><input type="checkbox"/> Width: 375 mm (14.8 in.)</li> <li><input type="checkbox"/> Depth: 347 mm (13.7 in.)</li> <li><input type="checkbox"/> Height: 151 mm (5.9 in.)</li> </ul> <p>Printing</p> <ul style="list-style-type: none"> <li><input type="checkbox"/> Width: 375 mm (14.8 in.)</li> <li><input type="checkbox"/> Depth: 347 mm (13.7 in.)</li> <li><input type="checkbox"/> Height: 151 mm (5.9 in.)</li> </ul>
------------	--

## Appendix

Weight*	Approx. 4.4 kg (9.7 lb)
---------	-------------------------

\* Without the ink and the power cord.

## Electrical Specifications

Model	100 to 240 V Model	220 to 240 V Model
Rated Frequency Range	50 to 60 Hz	50 to 60 Hz
Rated Current	0.5 to 0.2 A	0.3 A
Power Consumption (with USB Connection)	Printing: Approx. 13.0 W (ISO/IEC24712) Ready mode: Approx. 3.3 W Sleep mode: Approx. 0.7 W Power off: Approx. 0.2 W	Printing: Approx. 13.0 W (ISO/IEC24712) Ready mode: Approx. 3.3 W Sleep mode: Approx. 0.7 W Power off: Approx. 0.2 W

**Note:**

- Check the label on the printer for its voltage.
- For European users, see the following Website for details on power consumption.

<http://www.epson.eu/energy-consumption>

## Environmental Specifications

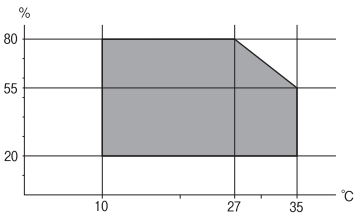
Operation	Use the printer within the range shown in the following graph.  Temperature: 10 to 35°C (50 to 95°F) Humidity: 20 to 80% RH (without condensation)
Storage	Temperature: -20 to 40°C (-4 to 104°F)* Humidity: 5 to 85% RH (without condensation)

\* You can store for one month at 40°C (104°F).

## Environmental Specifications for Ink Bottles

Storage Temperature	-20 to 40 °C (-4 to 104 °F)*
---------------------	------------------------------

## Appendix

Freezing Temperature	-15 °C (5 °F) Ink thaws and is usable after approximately 2 hours at 25 °C (77 °F).
----------------------	--

\* You can store for one month at 40 °C (104 °F).

## System Requirements

- Windows 10 (32-bit, 64-bit)/Windows 8.1 (32-bit, 64-bit)/Windows 8 (32-bit, 64-bit)/Windows 7 (32-bit, 64-bit)/Windows Vista (32-bit, 64-bit)/Windows XP SP3 or later (32-bit)/Windows XP Professional x64 Edition SP2 or later/Windows Server 2016/Windows Server 2012 R2/Windows Server 2012/Windows Server 2008 R2/Windows Server 2008/Windows Server 2003 R2/Windows Server 2003 SP2 or later
- macOS High Sierra/macOS Sierra/OS X El Capitan/OS X Yosemite/OS X Mavericks/OS X Mountain Lion/Mac OS X v10.7.x/Mac OS X v10.6.8

### Note:

- Mac OS may not support some applications and features.
- The UNIX File System (UFS) for Mac OS is not supported.

---

## Regulatory Information

### Standards and Approvals

#### Standards and Approvals for U.S. Model

Safety	UL60950-1 CAN/CSA-C22.2 No.60950-1
EMC	FCC Part 15 Subpart B Class B CAN/CSA-CEI/IEC CISPR 22 Class B

This equipment contains the following wireless module.

Manufacturer: Seiko Epson Corporation

Type: J26H006

This product conforms to Part 15 of the FCC Rules and RSS-210 of the IC Rules. Epson cannot accept responsibility for any failure to satisfy the protection requirements resulting from a non-recommended modification of the product. Operation is subject to the following two conditions: (1) this device may not cause harmful interference, and (2) this device must accept any interference received, including interference that may cause undesired operation of the device.

To prevent radio interference to the licensed service, this device is intended to be operated indoors and away from windows to provide maximum shielding. Equipment (or its transmit antenna) that is installed outdoors is subject to licensing.

This equipment complies with FCC/IC radiation exposure limits set forth for an uncontrolled environment and meets the FCC radio frequency (RF) Exposure Guidelines in Supplement C to OET65 and RSS-102 of the IC radio



## Appendix

frequency (RF) Exposure rules. This equipment should be installed and operated so that the radiator is kept at least 7.9 inches (20 cm) or more away from a person's body (excluding extremities: hands, wrists, feet and ankles).

### Standards and Approvals for European Model

For European users

Hereby, Seiko Epson Corporation declares that the following radio equipment model is in compliance with Directive 2014/53/EU. The full text of the EU declaration of conformity is available at the following website.

<http://www.epson.eu/conformity>

B632B

For use only in Ireland, UK, Austria, Germany, Liechtenstein, Switzerland, France, Belgium, Luxemburg, Netherlands, Italy, Portugal, Spain, Denmark, Finland, Norway, Sweden, Iceland, Croatia, Cyprus, Greece, Slovenia, Malta, Bulgaria, Czech, Estonia, Hungary, Latvia, Lithuania, Poland, Romania, and Slovakia.

Epson cannot accept responsibility for any failure to satisfy the protection requirements resulting from a non-recommended modification of the products.



### Standards and Approvals for Australian Model

EMC	AS/NZS CISPR32 Class B
-----	------------------------

Epson hereby declares that the following equipment Models are in compliance with the essential requirements and other relevant provisions of AS/NZS4268:

B632B

Epson cannot accept responsibility for any failure to satisfy the protection requirements resulting from a non-recommended modification of the products.

### Restrictions on Copying

Observe the following restrictions to ensure the responsible and legal use of the printer.

Copying of the following items is prohibited by law:

- Bank bills, coins, government-issued marketable securities, government bond securities, and municipal securities
- Unused postage stamps, pre-stamped postcards, and other official postal items bearing valid postage
- Government-issued revenue stamps, and securities issued according to legal procedure

Exercise caution when copying the following items:

- Private marketable securities (stock certificates, negotiable notes, checks, etc.), monthly passes, concession tickets, etc.
- Passports, driver's licenses, warrants of fitness, road passes, food stamps, tickets, etc.

**Note:**

*Copying these items may also be prohibited by law.*

## Appendix

Responsible use of copyrighted materials:

Printers can be misused by improperly copying copyrighted materials. Unless acting on the advice of a knowledgeable attorney, be responsible and respectful by obtaining the permission of the copyright holder before copying published material.

---

## Transporting and Storing the Printer

When you need to store the printer or transport it when moving or for repairs, follow the steps below to pack the printer.

**!** *Important:*

- When storing or transporting the printer, place the printer in the plastic bag and fold it closed. Avoid tilting the printer, placing it vertically, or turning it upside down; otherwise ink may leak.*

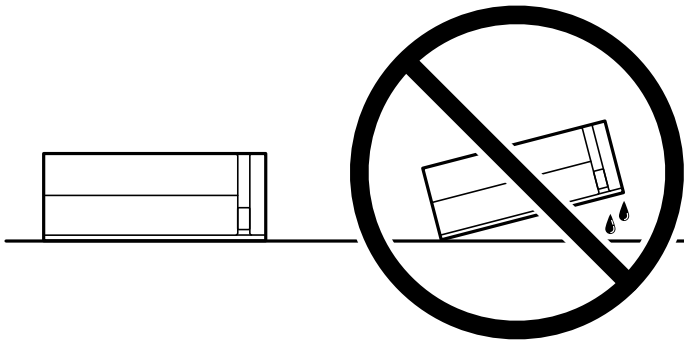

- When storing or transporting an ink bottle, do not tilt the bottle and do not subject it to impacts or temperature changes. Otherwise, ink may leak even if the cap on the ink bottle is tightened securely. Be sure to keep the ink bottle upright when tightening the cap, and take precautions to prevent ink from leaking when transporting the bottle, for example, putting the bottle in a bag.*
- Do not put opened ink bottles in the box with printer.*



1. Turn off the printer by pressing the  button.

## Appendix

2. Make sure the power light turns off, and then unplug the power cord.

**!** *Important:*

*Unplug the power cord when the power light is off. Otherwise, the print head does not return to the home position causing the ink to dry, and printing may become impossible.*

3. Disconnect all cables such as the power cord and USB cable.
4. Remove all of the paper from the printer.
5. Open the printer cover. Secure the print head to the case with tape.

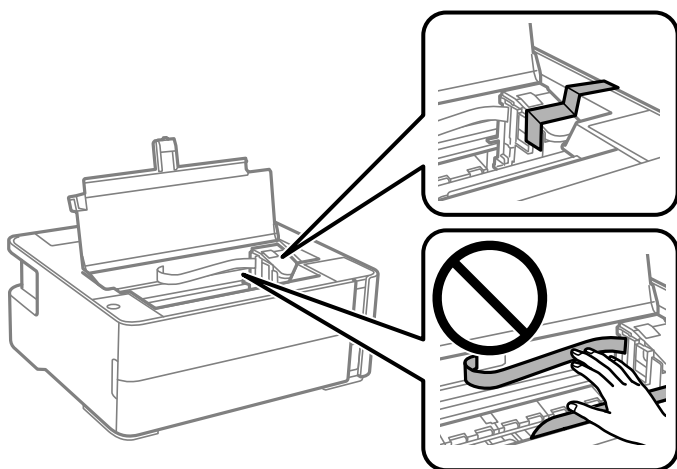

6. Make sure to close the ink tank cap securely.

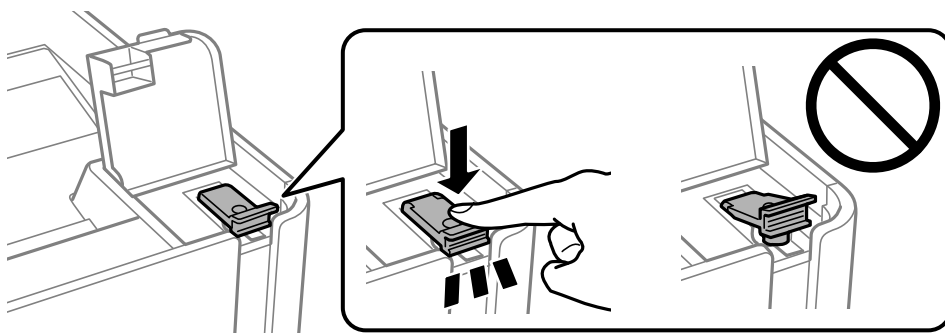

7. Close the ink tank cover securely.

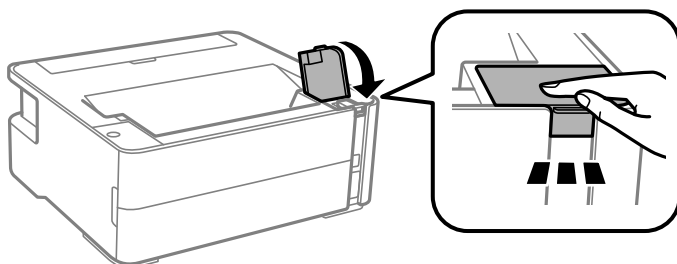

8. Place the printer in the plastic bag and fold it closed.

## Appendix

- Pack the printer in its box using the protective materials.

**Important:**

*Make sure you keep the printer horizontal when transporting or storing the printer by packing it in its box; otherwise ink may leak.*

When you use the printer again, make sure you remove the tape securing the print head. If print quality has declined the next time you print, clean and align the print head.

### Related Information

- ➔ [“Part Names and Functions” on page 11](#)
- ➔ [“Check if Nozzles are Clogged \(Nozzle Check\)” on page 79](#)
- ➔ [“Aligning the Print Head” on page 85](#)

---

## Copyright

No part of this publication may be reproduced, stored in a retrieval system, or transmitted in any form or by any means, electronic, mechanical, photocopying, recording, or otherwise, without the prior written permission of Seiko Epson Corporation. No patent liability is assumed with respect to the use of the information contained herein. Neither is any liability assumed for damages resulting from the use of the information herein. The information contained herein is designed only for use with this Epson product. Epson is not responsible for any use of this information as applied to other products.

Neither Seiko Epson Corporation nor its affiliates shall be liable to the purchaser of this product or third parties for damages, losses, costs, or expenses incurred by the purchaser or third parties as a result of accident, misuse, or abuse of this product or unauthorized modifications, repairs, or alterations to this product, or (excluding the U.S.) failure to strictly comply with Seiko Epson Corporation's operating and maintenance instructions.

Seiko Epson Corporation and its affiliates shall not be liable for any damages or problems arising from the use of any options or any consumable products other than those designated as Original Epson Products or Epson Approved Products by Seiko Epson Corporation.

Seiko Epson Corporation shall not be held liable for any damage resulting from electromagnetic interference that occurs from the use of any interface cables other than those designated as Epson Approved Products by Seiko Epson Corporation.

© 2018 Seiko Epson Corporation

The contents of this manual and the specifications of this product are subject to change without notice.

---

## Trademarks

- EPSON® is a registered trademark, and EPSON EXCEED YOUR VISION or EXCEED YOUR VISION is a trademark of Seiko Epson Corporation.
- PRINT Image Matching™ and the PRINT Image Matching logo are trademarks of Seiko Epson Corporation. Copyright © 2001 Seiko Epson Corporation. All rights reserved.
- QR Code is a registered trademark of DENSO WAVE INCORPORATED in Japan and other countries.
- Microsoft®, Windows®, Windows Server®, and Windows Vista® are registered trademarks of Microsoft Corporation.

## Appendix

- Apple, Macintosh, macOS, OS X, Bonjour, ColorSync, Safari, iPad, iPhone, iPod touch, and iTunes are trademarks of Apple Inc., registered in the U.S. and other countries.
- Google Cloud Print, Chrome, Chrome OS, Google Play and Android are trademarks of Google Inc.
- Adobe and Adobe Reader are either registered trademarks or trademarks of Adobe Systems Incorporated in the United States and/or other countries.
- General Notice: Other product names used herein are for identification purposes only and may be trademarks of their respective owners. Epson disclaims any and all rights in those marks.

---

## Where to Get Help

### Technical Support Web Site

If you need further help, visit the Epson support website shown below. Select your country or region and go to the support section of your local Epson website. The latest drivers, FAQs, manuals, or other downloadables are also available from the site.

<http://support.epson.net/>

<http://www.epson.eu/Support> (Europe)

If your Epson product is not operating properly and you cannot solve the problem, contact Epson support services for assistance.

### Contacting Epson Support

#### Before Contacting Epson

If your Epson product is not operating properly and you cannot solve the problem using the troubleshooting information in your product manuals, contact Epson support services for assistance. If Epson support for your area is not listed below, contact the dealer where you purchased your product.

Epson support will be able to help you much more quickly if you give them the following information:

- Product serial number  
(The serial number label is usually on the back of the product.)
- Product model
- Product software version  
(Click **About**, **Version Info**, or a similar button in the product software.)
- Brand and model of your computer
- Your computer operating system name and version
- Names and versions of the software applications you normally use with your product

**Note:**

*Depending on the product, network settings may be stored in the product's memory. Due to breakdown or repair of a product, settings may be lost. Epson shall not be responsible for the loss of any data, for backing up or recovering settings even during a warranty period. We recommend that you make your own backup data or take notes.*

## Appendix

### Help for Users in Europe

Check your Pan-European Warranty Document for information on how to contact Epson support.

### Help for Users in Taiwan

Contacts for information, support, and services are:

#### World Wide Web

<http://www.epson.com.tw>

Information on product specifications, drivers for download, and products enquiry are available.

#### Epson HelpDesk

Phone: +886-2-80242008

Our HelpDesk team can help you with the following over the phone:

- Sales enquiries and product information
- Product usage questions or problems
- Enquiries on repair service and warranty

#### Repair service center:

<http://www.tekcare.com.tw/branchMap.page>

TekCare corporation is an authorized service center for Epson Taiwan Technology & Trading Ltd.

### Help for Users in Australia

Epson Australia wishes to provide you with a high level of customer service. In addition to your product manuals, we provide the following sources for obtaining information:

#### Internet URL

<http://www.epson.com.au>

Access the Epson Australia World Wide Web pages. Worth taking your modem here for the occasional surf! The site provides a download area for drivers, Epson contact points, new product information and technical support (e-mail).

#### Epson Helpdesk

Phone: 1300-361-054

Epson Helpdesk is provided as a final backup to make sure our clients have access to advice. Operators on the Helpdesk can aid you in installing, configuring and operating your Epson product. Our Pre-sales Helpdesk staff can provide literature on new Epson products and advise where the nearest dealer or service agent is located. Many types of queries are answered here.

We encourage you to have all the relevant information on hand when you ring. The more information you prepare, the faster we can help solve the problem. This information includes your Epson product manuals, type of computer, operating system, application programs, and any information you feel is required.

## Appendix

### Transportation of Product

Epson recommends retaining product packaging for future transportation. Securing the ink tank with tape and keeping the product upright is also recommended.

### Help for Users in New Zealand

Epson New Zealand wishes to provide you with a high level of customer service. In addition to your product documentation, we provide the following sources for obtaining information:

#### Internet URL

<http://www.epson.co.nz>

Access the Epson New Zealand World Wide Web pages. Worth taking your modem here for the occasional surf! The site provides a download area for drivers, Epson contact points, new product information and technical support (e-mail).

#### Epson Helpdesk

Phone: 0800 237 766

Epson Helpdesk is provided as a final backup to make sure our clients have access to advice. Operators on the Helpdesk can aid you in installing, configuring and operating your Epson product. Our Pre-sales Helpdesk staff can provide literature on new Epson products and advise where the nearest dealer or service agent is located. Many types of queries are answered here.

We encourage you to have all the relevant information on hand when you ring. The more information you prepare, the faster we can help solve the problem. This information includes your Epson product documentation, type of computer, operating system, application programs, and any information you feel is required.

### Transportation of Product

Epson recommends retaining product packaging for future transportation. Securing the ink tank with tape and keeping the product upright is also recommended.

### Help for Users in India

Contacts for information, support, and services are:

#### World Wide Web

<http://www.epson.co.in>

Information on product specifications, drivers for download, and products enquiry are available.

#### Helpline

- Service, product information, and ordering consumables (BSNL Lines)

Toll-free number: 18004250011

Accessible 9am to 6pm, Monday through Saturday (Except public holidays)

- Service (CDMA & Mobile Users)

Toll-free number: 186030001600

Accessible 9am to 6pm, Monday through Saturday (Except public holidays)