

Introduction

Thank you for purchasing the Epson R-D1s. Please follow the instructions in this guide to set up and start using your camera.



Warnings must be followed carefully to avoid bodily injury.



Cautions must be observed to avoid damage to your equipment.

Notes contain important information and useful tips on the operation of your product.

Components

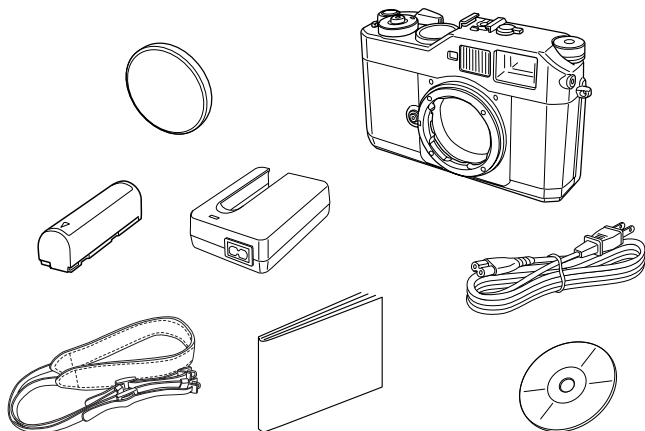

Top View

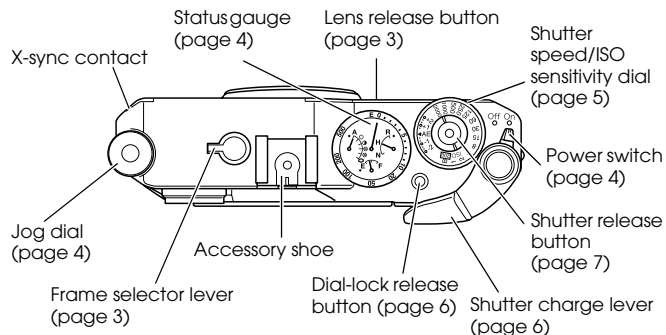

Back View

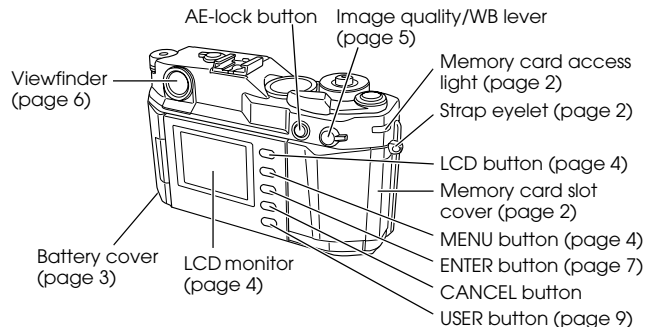

Attach the Strap to the Camera

1. Remove the protective pads and metal rings from the strap.

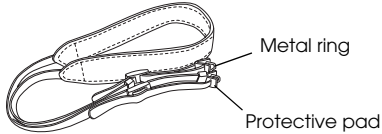

2. Attach the protective pad and metal ring to the strap eyelet.

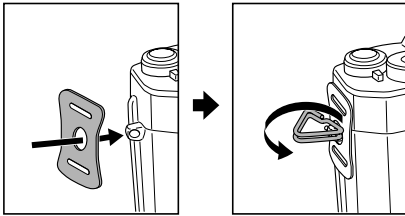

3. Lace the strap through the pad and the ring, then secure it with the plastic fasteners. Do the same on the other side of the camera.

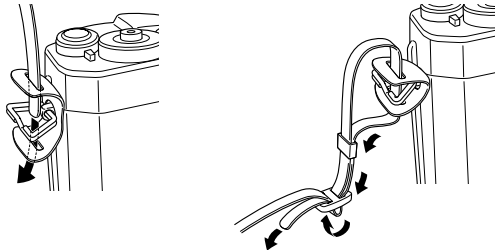

Insert a Memory Card

Open the memory card slot cover. Insert the memory card until it clicks, with the labeled side facing the back of the camera. Close the cover.

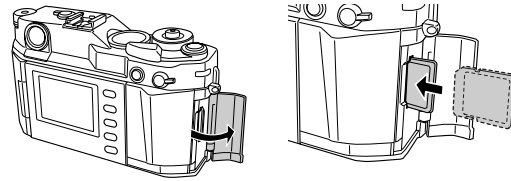

To remove the memory card later, push in the card to release it and then pull it out.



Caution:

Never remove the memory card while the memory card access light is on. This may cause data in the card to be lost or damaged, or make the memory card unusable.

Note:

If the memory card has been already formatted with a computer or another digital camera, you may not be able to save images on the card. If this happens, reformat the card using this camera. For instructions, see the User's Guide on the CD-ROM that came with your camera.

Charge and Install the Battery

Be sure to charge the battery before installing it in the camera. It takes about 3.5 hours to fully charge a new or empty battery.

Open the battery cover and insert the battery as far as it goes. Close the cover until it clicks.

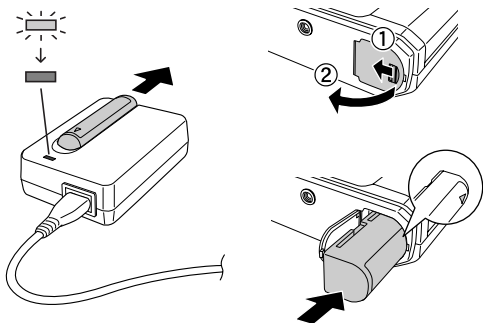

The battery is fully charged when the red light on the charger turns off.

Attach the Lens

You can attach either M-mount or L-mount lenses to the camera. For an L-mount lens, you will need a third-party adapter ring.



Caution:

- ❑ Do not use lenses that protrude more than 20.5 mm from the back of the mount base.
- ❑ If using a collapsible lens, do not press the lens barrel into the camera body.

Align the dot on the lens body with the red dot on the lens release button. Insert and rotate the lens clockwise until it clicks.

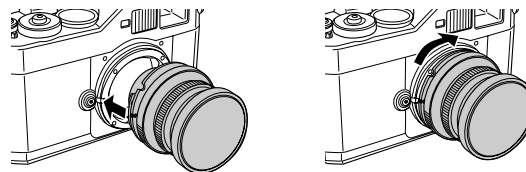

Select the Focal Length

Move the frame selector lever to select the focal length for the lens: 50 mm, 28 mm, or 35 mm. The bright-line frame for the selected focal length is displayed in the viewfinder.

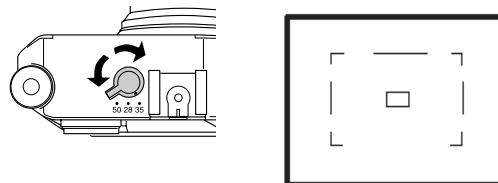

Turn on the Camera

To turn on the camera, move the power switch to the On position. The status gauge displays the current settings: white balance, remaining battery power, image quality, and the number of shots remaining (on the perimeter).

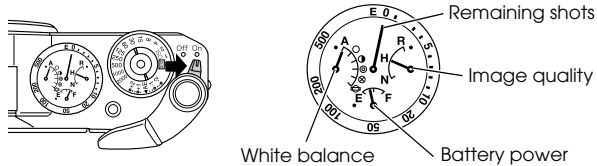

Caution:



Never turn off the camera while the memory card access light is on. This may cause data in the card to be lost or damaged, or render the memory card unusable.

Set Time and Date

Follow these steps to set the time and date:

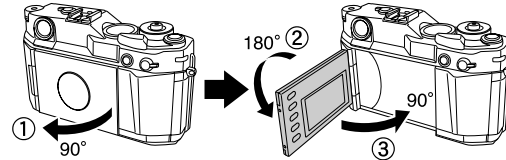
1. Pull open the LCD monitor, flip it over, and close it.



2. Press the  (LCD) button.
3. Rotate the jog dial to change the date as necessary, then press the  (MENU) button to display the next item.

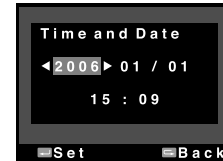
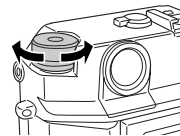

Set ISO Sensitivity

Pull up and rotate the outer ring of the shutter speed dial to select the ISO sensitivity: 200, 400, 800, or 1600.

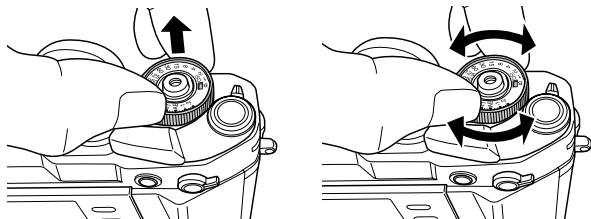

Set Image Quality

Pull up and hold the image quality/WB lever at the Q position, and rotate the jog dial to select the desired image quality setting on the status gauge.

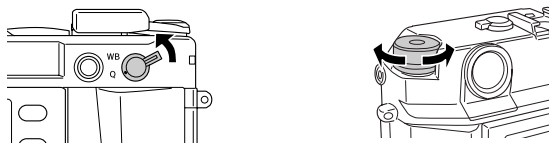

Select from the following:

R: RAW/RAW+JPEG (10/13 MB)

H: JPEG (High resolution: 3 MB)

N: JPEG (Normal resolution: 1.5 MB)

Set White Balance

Pull down and hold the image quality/WB lever at the WB position, and rotate the jog dial to select the white balance setting on the status gauge.

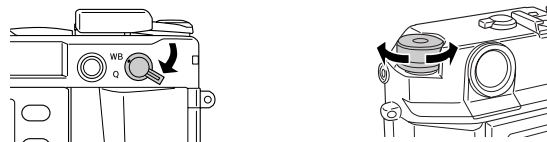

Select from the following:

- A Auto
- Sunny
- Shade
- ⊙ Cloudy
- ⊗ Incandescent
- ⊞ Fluorescent

Set Aperture

Rotate the lens aperture ring to the desired value.



Set Shutter Speed

Rotate the shutter speed dial to the desired value. Select AE for automatic exposure, or a desired shutter speed from 1 to 1/2000 second, or B (Bulb).

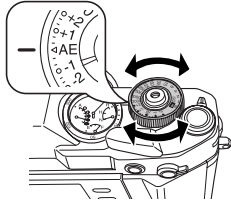

To change the setting, rotate the shutter speed dial while pressing the dial-lock release button.

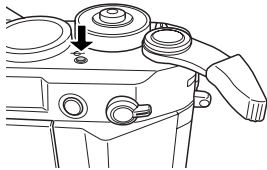

Taking a Picture

Cock the shutter before taking each picture.

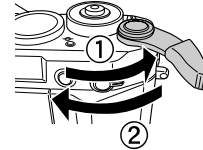

Look through the viewfinder and point to the subject. Rotate the focus ring on the lens until the double-image converges in the center of the bright-line frame.

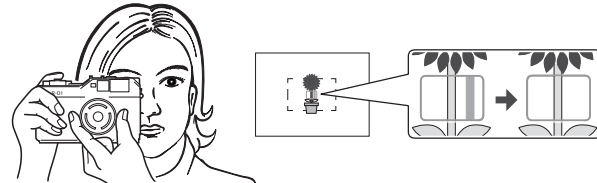

Press the shutter release button halfway to display the shutter speed in the viewfinder. If you set the shutter speed for manual exposure, the metered value flashes for your reference. For automatic exposure (i.e., AE on the shutter speed dial), the camera uses the displayed shutter speed.

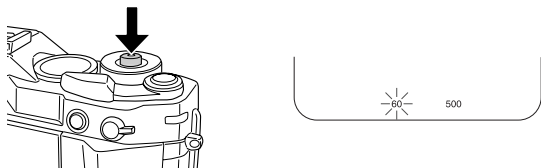



When you are ready, gently press the shutter release button all the way down to take a picture.

View Pictures

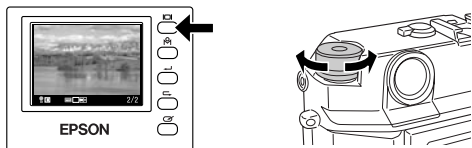
Press the  (LCD) button to view the saved picture. If you have taken more than one picture, rotate the jog dial to scroll through them.





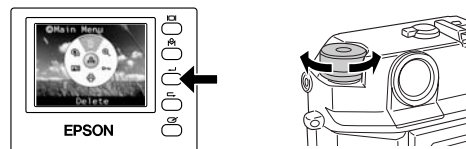

Delete Pictures

To delete a picture, rotate the jog dial to display the picture you want to delete. Press  (MENU), then  (ENTER) twice. Rotate the jog dial to select OK, then press  (ENTER) to delete the picture. Press the shutter release button to return to the shooting mode.



Customizing the Settings

1. Press  (LCD), then  (MENU) to display the Main menu on the LCD monitor.
2. Select  (Settings) using the jog dial, then press the  (ENTER) button to display the Settings menu.

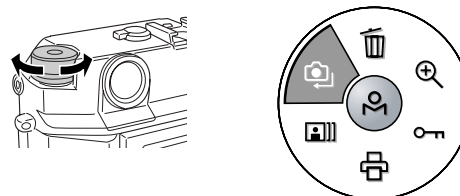







- Select the desired setting using the jog dial, then press the \leftarrow (ENTER) button. The selected setting is displayed.
If you select \odot (Basic Setup), select the desired setting using the jog dial and press the \leftarrow (ENTER) button again.
- Change the value or select the item using the jog dial, then press the \leftarrow (ENTER) button.

Setting Items

You can change the following camera settings through the Settings menu.

Settings Menu

Setting	Description
 (Color Setting)	Selects whether to save images in Color or Monochrome . For Monochrome, you can select the Monochrome Filter by pressing the MENU button.
\odot (Basic Setup)	Displays the Basic Setup menu. See "Basic Setup Menu" on the next page.
 (Format SD Card)	Formats the memory card. You can select Quick Format or Full Format .

Setting	Description																		
 (Initialize Settings)	Resets the current settings (except date and time) to their default settings as shown below. <table border="1" data-bbox="1038 194 1465 445"> <thead> <tr> <th>Setting</th> <th>Default Value</th> </tr> </thead> <tbody> <tr> <td>Color</td> <td>Color</td> </tr> <tr> <td>Film</td> <td>Standard</td> </tr> <tr> <td>Date</td> <td>YYYY/MM/DD</td> </tr> <tr> <td>Power Save Timer</td> <td>5min</td> </tr> <tr> <td>Sequential Numbering</td> <td>On</td> </tr> <tr> <td>LCD Brightness</td> <td>5/8</td> </tr> <tr> <td>Language</td> <td>English</td> </tr> <tr> <td>USER Button</td> <td>Delete</td> </tr> </tbody> </table>	Setting	Default Value	Color	Color	Film	Standard	Date	YYYY/MM/DD	Power Save Timer	5min	Sequential Numbering	On	LCD Brightness	5/8	Language	English	USER Button	Delete
Setting	Default Value																		
Color	Color																		
Film	Standard																		
Date	YYYY/MM/DD																		
Power Save Timer	5min																		
Sequential Numbering	On																		
LCD Brightness	5/8																		
Language	English																		
USER Button	Delete																		
 (Long Exp Noise Reduction)	Reduces noise that appears on an image taken with a long exposure. The shooting time may become longer depending on shooting conditions.																		
 (Color Space)	Selects the color space from sRGB or Adobe RGB . Adobe RGB is a wider color space than sRGB and encompasses the colors that can be printed with CMYK inks. Select Adobe RGB if you have a printer that supports it.																		
 (RAW Setting)	Sets the image format recorded when shooting in RAW mode. You can select RAW format only, or both RAW and JPEG (high resolution) format in a single file. RAW+JPEG provides the convenience of viewing the JPEG image on most computers while retaining the RAW data for postprocessing, at an increase in image size and memory card access time.																		

Setting	Description
 (Film Setting)	Allows you to quickly switch film profiles to best suit the shooting subject or environment. For each film profile (Film1 , Film2 , or Film3), you can assign Edge Enhance , Saturation , Tint , Contrast , and NR (Noise Reduction). By default, Film1 is preset for portrait, Film2 for landscape, and Film3 for night pictures. Use Standard if no particular profile is required.

🕒 Basic Setup Menu

Setting	Description
Time and Date	Sets the current date and time (year , month , day , hours and minutes).
Date Format	Selects date display format from the following: YYYY/MM/DD (default setting), MM/DD/YYYY , DD/MM/YYYY
Power Save Timer	Selects the length of time before the camera enters the power save mode, in which the LCD monitor is turned off automatically to reduce power consumption. The available settings are 3min , 5min (default setting), 10min , or 20min . Press any button to exit the power save mode.
Sequential Numbering	Specifies whether to save images with a sequential number (as part of the file name). On (default): sequential numbers continue even if the memory card is replaced. Off : sequential numbers end and a new sequence of numbers starts when the memory card is replaced.

Setting	Description
LCD Brightness	Changes brightness of the LCD monitor. Also shows the firmware version.
Language	Selects the language for messages and menus displayed on the LCD monitor from the following: Japanese , English , French , German , Italian , Spanish , Dutch , T (Traditional)- Chinese Note: <i>The languages available may vary depending on the country of purchase.</i>
Calibrate Needles	Displays the Needle Calibration menu to adjust the status gauge needles.
Dead Pixel Correction	Corrects non-functional pixels so they are less conspicuous on the LCD monitor. Repeat this procedure every few months as necessary. For the pixels that cannot be corrected with this setting, try the Long Exp Noise Reduction feature. Note: <i>Be sure to attach the lens cap before executing this function. Make sure the battery has enough power left when using this feature.</i>
Quick View	Displays the image on the LCD monitor (i.e., enters the playback mode) automatically when you release the shutter. You can select the time period during which each image is displayed on the LCD monitor, from 3 sec or 10 sec .
Assign USER Button	You can assign one of the following functions to the  (USER) button: Delete , Lock , Magnify , Print , and Film . By default, Delete is assigned to this button.

Learning More About the Camera

For more information about the camera, see the *Epson R-D1s User's Guide* PDF on the CD-ROM that came with your camera.

Note:

Adobe Reader must be installed on your computer for you to be able to read the User's Guide. For more information, consult the Adobe Systems Incorporated web site.

Safety Instructions

Read all of these instructions before using this product, and keep this guide handy for later reference. Follow all warnings and instructions marked on this product and the options.

When using the camera

- Follow all warnings and instructions marked on this product.
- Do not expose the camera to severe impact; doing so may cause malfunctions especially while the camera is operating.
- Do not insert objects into any of the camera's openings.
- Do not touch the components inside this product unless instructed to do so in the user documentation. Never force this product's components into place. Although this product is designed to be sturdy, rough handling can damage it.
- Protect the camera from rapid temperature change.
- Never spill liquid onto this product.
- If this product emits unusual noises, odors, or smoke, cancel the current operation and turn it off immediately. Remove the battery from the product. Contact Customer Support.

- To prevent fire or electric shock, do not cover this product with a blanket or other covering that may give off a static electric shock.
- To prevent fire or electric shock, do not expose this product or its options to rain or moisture.
- To prevent fire or explosion, do not use this product where flammable or volatile gas is stored.
- Do not use this product outdoors during a thunderstorm.
- Do not use this product after moving it between extreme temperatures, which may cause condensation to form on electronic parts.
- To prevent possible injury, do not take flash pictures in close proximity to anyone's eyes.
- Do not insert your finger into the camera or EM mount.
- If the liquid crystal solution contained in the LCD monitor leaks out and gets on your hands, wash them thoroughly with soap and water. If it gets into your eyes, flush them immediately with water.
- If you use this product in places where the use of electronic devices is limited, such as in airplanes or hospitals, follow all instructions in those places.

When using the strap

- Do not swing the camera about. This can damage the camera or other objects, or cause injury.
- Do not pull or tighten the strap too much when wearing it; this can cause serious injury.
- Keep the strap away from children.

When using the battery

Follow these precautions when using the battery: mishandling it may cause injury.

- ❑ If battery acid gets into your eyes or on your skin, immediately rinse the affected area thoroughly with water and seek medical treatment. If a battery is swallowed, seek medical treatment immediately.
- ❑ Use only an Epson lithium-ion battery for this camera according to the directions in the user documentation.
- ❑ Do not use the battery that comes with this product for other devices.
- ❑ To protect against short-circuiting, do not remove the outside sleeves of the battery.
- ❑ Do not handle the battery with wet hands or use it near water.
- ❑ Do not expose the battery to water or high humidity.
- ❑ Do not drop, puncture, disassemble, mutilate, or short-circuit the battery.
- ❑ Do not expose the battery to heat, fire, or water.
- ❑ Do not use batteries that are leaking or damaged in any way.
- ❑ Do not charge the battery on battery chargers other than the one provided with this product.
- ❑ Do not charge the battery near open flame or in very hot locations.
- ❑ Keep the battery away from heat sources.
- ❑ Prevent the battery from coming into contact with metal objects that could short-circuit it, such as coins or keys.
- ❑ Do not solder wires or terminals directly to the battery.
- ❑ Do not touch battery terminals.
- ❑ Keep the battery away from open flame.
- ❑ If overheating, discoloration, distortion, a strange smell or any other abnormal situations occur, remove the battery from this product and do not use it.

- ❑ Keep batteries out of the reach of children.
- ❑ If charging has not finished after the regular charging time, stop charging.
- ❑ Do not place the battery into a high-pressured container or a microwave oven.
- ❑ Do not insert the battery into electrical outlets or other power sources such as cigarette lighters.
- ❑ Charge the battery before using it. The battery is not fully charged when you purchase it.

When storing the battery

- ❑ When not using this product for a long period, remove the battery and store it separately.
- ❑ Do not store the battery where temperature or humidity is very high.
- ❑ Store the battery out of children's reach.
- ❑ Discharge the battery completely before storing it for a long time.
- ❑ When not using the battery for a long time, charge the battery and then discharge it completely about once a year during storage.

When disposing of the battery

Before disposing of the battery, make sure you discharge it completely.



Warning:

- ❑ Be sure to completely cover both ends of the battery with tape to prevent combustion or explosion when disposing of it.
- ❑ Do not dispose of the battery as ordinary refuse. Instead, dispose of it in a collection or recycle box in accordance with local laws.

For the Netherlands users:

Do not dispose of the battery with ordinary refuse. Instead, dispose of it as small chemical waste in accordance with local laws, and the following Dutch Government Gazette 45, KCA Marking:



Bij dit produkt zijn batterijen geleverd. Wanneer deze leeg zijn, moet u ze niet weggooien maar inleveren als KCA.

For German users:

Do not dispose of the battery with ordinary refuse. Instead, dispose of it in a recycle box in accordance with local laws.

For North America and Canada Users:



This mark indicates that the battery will be recycled by RBRC. When you dispose of the battery, contact RBRC.

When using the battery charger

IMPORTANT SAFETY INSTRUCTIONS



Warning:

Read all relevant safety and operating instructions before using this product, as misuse could result in personal injury from fire, explosion, leakage, overheating, or electric shock.

These safety and operating instructions should be kept for future reference.

- ❑ Use only the Epson battery charger provided to charge the Epson lithium-ion battery Model EU-85. Never attempt to charge other types of batteries in this charger as they may explode, leak, overheat, or cause personal injury.
- ❑ Do not charge primary (non-rechargeable) batteries.
- ❑ Do not handle the battery charger with wet hands or use it near water.
- ❑ Do not expose the battery charger to water or high humidity.
- ❑ Use only the type of power source indicated on the battery charger's label, and always supply power directly from a standard, domestic power outlet with a power cord that meets the relevant local safety standards.
- ❑ Place the battery charger near an electrical outlet where the power cord can be easily unplugged.
- ❑ The battery charger is designed for use and provided with this product. Do not attempt to use it with other electronic devices unless specified.
- ❑ The battery charger included is designed for use with this product. Use of any other battery charger could result in fire, electrical shock, or injury.
- ❑ Use only a power source that meets the power requirements indicated on the label attached to the product. If you are not sure of the power supply specifications in your area, contact your local power company or contact Customer Support.
- ❑ Make sure the total amperage of all devices plugged into the power outlet does not exceed the power outlet's ampere rating.
- ❑ If you plan to use this product in Germany, the building installation must be protected by a 16 amp circuit breaker to provide adequate short-circuit protection and over-current protection for this product.
- ❑ Do not use a damaged or frayed battery charger.

- ❑ If you use an extension cord with this product, make sure the total amperage of all devices plugged into the extension cord does not exceed the cord's ampere rating.
- ❑ Never disassemble, modify, or attempt to repair the battery charger by yourself except as specifically explained in this guide.
- ❑ Do not use power outlets controlled by wall switches or automatic timers.
- ❑ Do not use power outlets on the same circuit as large motors or other appliances that may cause voltage fluctuations.
- ❑ Avoid using outlets on the same circuit as photocopiers or air conditioning systems that regularly switch on and off.
- ❑ Position this product's power cord so that it will not be stepped on or run over.
- ❑ Do not place any objects on the power cord or the battery charger.
- ❑ Keep the power cord straight at the ends and at the points where it enters the transformer.
- ❑ The power cord should be placed to avoid abrasions, cuts, fraying, crimping, kinking, and other damage.
- ❑ If you cannot insert the plug into the power outlet, contact an electrician.

For US and Canadian users:

Use the power cord provided or a 6 to 10 foot UL-approved type SPT-2 or heavier type, 2 X 18 AWG cord with a 125 V 10 A plug and 125 V 7 A connector.

When using a memory card

- ❑ Only memory cards designed for the product's specifications can be used.
- ❑ The methods for using memory cards vary according to card type. Be sure to refer to the documentation included with your memory card for details.

- ❑ Do not remove the memory card while the power switch is on.

When using the LCD

- ❑ The LCD monitor on this product may contain a few small bright or dark spots. These are normal and do not mean that your LCD monitor is damaged in any way.
- ❑ If the LCD monitor on this product is damaged, consult your dealer.
- ❑ If the liquid crystal solution contained in the LCD monitor on this product leaks out and gets onto your hands, wash them thoroughly with soap and water. If it gets into your eyes, flush them immediately with water. If discomfort or vision problems remain after a thorough flushing, see a doctor immediately.
- ❑ Only use a soft, dry cloth to clean the display. Do not use liquid or chemical cleaners.

When storing, maintaining, or transporting the camera

- ❑ Do not store this product outdoors.
- ❑ Do not store this product near water.
- ❑ Do not store this product in a location subject to high temperature or humidity.
- ❑ Do not store this product in a location subject to rapid changes in temperature or humidity.
- ❑ Do not store this product in a location subject to direct sunlight or strong light sources.

For United Kingdom, Hong Kong, and Singapore users

Replace fuses only with fuses of the correct size and rating.

For United Kingdom users

Safety information



Warning:

Refer to the rating plate for voltage and check that the appliance voltage corresponds to the supply voltage.

Important:

The wires in the mains lead fitted to this appliance are coloured in accordance to the following code:

Blue - Neutral

Brown - Live

If you have to fit a plug:

As the colours of the mains lead of this appliance may not match coloured markings used to identify the terminals in a plug, please proceed as follows:

The blue wire must be connected to the terminal in the plug marked with the letter N.

The brown wire must be connected to the terminal in the plug marked with the letter L.

If damage occurs to the plug, replace the cord set or consult a qualified electrician.

Copyright

Copyright © 2006 Seiko Epson Corporation. All rights reserved.

No part of this publication may be reproduced, stored in a retrieval system, or transmitted in any form or by any means, electronic, mechanical, photocopying, recording, or otherwise, without the prior written permission of Seiko Epson Corporation. The information contained herein is designed only for use with this Epson product. Epson is not responsible for any use of this information as applied to other products.

Trademarks

EPSON is a registered trademark of Seiko Epson Corporation.

Adobe and Adobe Reader are registered trademarks of Adobe System Incorporated.

SD is a trademark.

General Notice: Other product names used herein are for identification purposes only and may be trademarks of their respective owners. Epson disclaims any and all rights in those marks.