

SC-T7200 Series
SC-T5200 Series
SC-T3200 Series
SC-T7200D Series
SC-T5200D Series

User's Guide

Copyrights and Trademarks

Copyrights and Trademarks

No part of this publication may be reproduced, stored in a retrieval system, or transmitted in any form or by any means, electronic, mechanical, photocopying, recording, or otherwise, without the prior written permission of Seiko Epson Corporation. The information contained herein is designed only for use with this Epson printer. Epson is not responsible for any use of this information as applied to other printers.

Neither Seiko Epson Corporation nor its affiliates shall be liable to the purchaser of this product or third parties for damages, losses, costs, or expenses incurred by the purchaser or third parties as a result of accident, misuse, or abuse of this product or unauthorized modifications, repairs, or alterations to this product, or (excluding the U.S.) failure to strictly comply with Seiko Epson Corporation's operating and maintenance instructions.

Seiko Epson Corporation shall not be liable for any damages or problems arising from the use of any options or any consumable products other than those designated as Original Epson Products or Epson Approved Products by Seiko Epson Corporation.

Seiko Epson Corporation shall not be held liable for any damage resulting from electromagnetic interference that occurs from the use of any interface cables other than those designated as Epson Approved Products by Seiko Epson Corporation.

EPSON®, Epson UltraChrome®, EPSON EXCEED YOUR VISION, EXCEED YOUR VISION and their logos are registered trademarks or trademarks of Seiko Epson Corporation.

Microsoft®, Windows®, Windows Vista® and PowerPoint® are registered trademarks of Microsoft Corporation.

Apple, Mac, macOS, OS X, Bonjour, ColorSync are registered trademarks of Apple Inc.

Intel® is a registered trademark of Intel Corporation.

PowerPC® is a registered trademark of International Business Machines Corporation.

Adobe, Adobe RGB (1998), Lightroom, Photoshop, PostScript, PostScript®3™, and Reader are either registered trademarks or trademarks of Adobe Systems Incorporated in the United States and/or other countries.

HP-GL/2® and HP RTL® are registered trademarks of Hewlett-Packard Corporation.

Android is a trademark of Google Inc.

General Notice: Other product names used herein are for identification purposes only and may be trademarks of their respective owners. Epson disclaims any and all rights in those marks.

© 2018 Seiko Epson Corporation. All rights reserved.

Contents

Contents

Copyrights and Trademarks

Introduction

Important Safety Instructions. 6

 When choosing a place for this product. 6

 When setting up this product. 6

 When using this product. 6

 When handling the ink cartridges. 7

Note on this Guide. 7

 Meaning of Symbols. 7

 Illustrations. 7

 Operating System Versions. 7

Printer Parts. 9

 Front. 9

 Back. 12

 Roll 2 unit (SC-T7200D Series/SC-T5200D Series). 13

 Roll paper adapter. 13

 Control panel. 14

 Screen View. 15

Features. 18

 Realizing High Productivity. 18

 Realizing High Resolution. 19

 Insistence on Ease-of-Use. 19

Notes on Usage and Storage. 20

 Installation space. 20

 Notes when using the printer. 21

 Notes when not using the printer. 21

 Notes on handling ink cartridges. 22

 Notes on handling paper. 22

Introducing the Supplied Software. 24

 Contents of the Software Disc. 24

 Overview of software installed on the printer 25

 Summary of the Printer Driver. 26

 How to use Remote Manager. 27

Basic Operations

Loading and Removing the Roll Paper. 29

 Attaching the Roll Paper Adapter. 29

 Loading Roll Paper or Roll 1. 30

 Loading Roll 2(SC-T7200D Series/SC-T5200D Series only). 33

 Cutting the roll paper. 34

 Removing Roll paper or Roll 1. 36

 Removing Roll 2(SC-T7200D Series/SC-T5200D Series only). 37

Loading and Removing Cut Sheets. 39

 Loading Cut Sheets. 39

 Removing Cut Sheets. 40

Loading and Removing Poster Board. 41

 Loading Poster Board. 41

 Removing Poster Board. 44

Viewing and Changing Media Settings. 45

Replacing Paper. 46

Using the Paper Basket (SC-T7200 Series/SC-T5200 Series/SC-T3200 Series). 47

 Storing and Opening. 48

 Adjusting the Position. 49

Using the Large-Capacity Paper Basket (SC-T7200D Series/SC-T5200D Series). 51

 Storing and Adjusting the Position. 51

Using the Auto Take-up Reel Unit (SC-T7200 Series Only). 53

 Using the Control Panel. 53

 Attaching the Paper. 54

 Removing Paper from the Auto Take-up Reel Unit. 57

Basic Printing Methods(Windows). 58

Basic Printing Methods(Mac OS X). 62

Printable area. 65

 Roll Paper Printable Area. 65

 Cut Sheets Printable Area. 66

Turning Off the Power Using Power Off Timer 67

Canceling Printing. 68

Saving to and Reprinting on the Optional Hard Disk Unit

Function Summary. 69

Saving Print Jobs. 70

Viewing, Printing and Deleting Saved Print Jobs 71

Copying and Scanning

Large Copying and Large Scanning using the MFP Scanner (Option). 73

 Function Summary. 73

 How to start Copy Manager. 74

Contents

Preparing to Scan.	75
Notes on Loading Documents in the Scanner	76
How to Load Documents.	77
How to change the document eject direction and scanning accuracy.	78
Large Copying.	79
Large Scan.	80
Operations for Image Files that were Scanned or Received.	81
Making Enlarged Copies with a A3 or A4 Scanner	83
Connecting the Scanner.	83
Making Enlarged Copies.	83
Placing Documents in the Scanner.	84
Print From Folder	
Function Summary.	86
Preparing to Print From Folder.	87
Procedure to Print From Folder.	87
More Ways to Print	
Enlargements and Horizontal and Vertical Banners.	89
Fitting Documents to the Width of the Roll Paper.	90
Choosing a Print Size.	91
Fitting Documents to the Output Size.	92
Printing at Non-Standard Sizes.	93
Printing CAD Drawings.	95
Printing in the CAD / Line Drawing mode of the printer driver.	95
Printing while Emulating HP-GL/2 and HP RTL.	96
Switching Roll Paper Automatically before Printing (SC-T7200D Series/SC-T5200D Series Only).	97
Switching to Roll 1/Roll 2 by Paper Type.	97
Switching to Roll 1/Roll 2 by Document Size	98
Switching to the Roll with the Most Paper Remaining (Roll 1/Roll 2) before Printing if the Paper Runs Out.	100
Borderless Printing.	102
Types of Borderless Printing Methods.	102
Supported Media Sizes for Borderless Printing	102
About Roll Paper Cutting.	104
Setting Procedures for Printing.	105

Correct color and print.	107
Multi-Page/Poster Printing.	110
Folded Double-Side (Windows only).	111
N-up.	111
Poster (Windows only).	112
Printing Multiple Documents (the Layout Manager)(Windows Only).	117
Setting Procedures for Printing.	118
Saving and Recalling Settings.	118

Color Management Printing

About Color Management.	120
Color Management Print Settings.	120
Setting profiles.	121
Setting color management with the applications	121
Setting color management with the printer driver	122
Color management printing by Host ICM (Windows).	122
Color management printing by ColorSync (Mac OS X).	123
Color management printing by Driver ICM(Windows Only).	124

Tips for Using the Printer Driver(Windows)

Displaying the Settings Screen.	126
From the control panel.	126
Displaying Help.	127
Click the Help Button to Display.	127
Right-click on the item you want to check and display.	127
Customizing the Printer Driver.	128
Saving various settings as your Select Settings	128
Adding Media Types.	128
Rearranging display items.	129
Overview of the Utility Tab.	130
Uninstalling the printer driver.	132

Tips for Using the Printer Driver(Mac OS X)

Displaying the Settings Screen.	133
Displaying Help.	133
Using Epson Printer Utility 4.	133

Contents

Starting Epson Printer Utility 4.	133	Supported Media.	212
Epson Printer Utility 4 Functions.	133	Epson Special Media Table.	212
Uninstalling the printer driver.	135	Usable Commercially Available Paper Size.	221
Removing EPSON LFP Remote Panel 2.	135	Before printing on non-Epson media.	222
Using the Control Panel Menu		Notes When Moving or Transporting the Printer	223
Menu Operations.	136	Notes When Moving the Printer.	223
Menu List.	138	Notes on Transporting.	224
Menu Descriptions.	147	Notes when reusing the printer.	225
Print Queues menu.	147	System Requirements.	225
Paper menu.	149	System Requirements of the Printer Driver.	225
Maintenance menu.	153	System Requirements for Copy Manager.	226
Setup menu.	154	Specifications Table.	226
Enlarged Copy menu.	173	Standards and Approvals.	229
Large Copy / Large Scan menu.	174	Where To Get Help	
Maintenance		Technical Support Web Site.	230
Adjusting the Print Head.	179	Contacting Epson Support.	230
Checking for clogged nozzles.	179	Before Contacting Epson.	230
Cleaning the print head.	180	Help for Users in North America.	231
Aligning print position misalignment (Head Alignment).	181	Help for Users in Europe.	231
Replacing Consumables.	185	Help for Users in Taiwan.	231
Replacing Ink Cartridges.	185	Help for Users in Australia.	232
Replacing Maintenance Boxes.	186	Help for Users in Singapore.	232
Replacing the Cutter.	187	Help for Users in Thailand.	233
Cleaning the Printer.	189	Help for Users in Vietnam.	233
Cleaning the outside.	189	Help for Users in Indonesia.	233
Cleaning the inside.	189	Help for Users in Hong Kong.	234
Cleaning the MFP Scanner (option).	191	Help for Users in Malaysia.	234
Problem Solver		Help for Users in India.	234
What to do When a Message is Displayed.	193	Help for Users in the Philippines.	235
When a Maintenance Call/Service Call Occurs.	197	Software License Terms	
Troubleshooting.	198	OPEN SOURCE SOFTWARE LICENSE.	236
You cannot print (because the printer does not work).	198		
The printer sounds like it is printing, but nothing prints.	200		
The prints are not what you expected.	200		
Feeding or ejecting problems.	204		
Others.	207		
Trouble when the optional MFP Scanner is connected.	207		
Appendix			
Options and Consumable Products.	210		

Introduction

Introduction

Important Safety Instructions

Read all of these instructions before using the printer. Also be sure to follow all warnings and instructions marked on the printer.

When choosing a place for this product

- ❑ Place this product on a flat, stable surface that is larger than this product. This product will not operate properly if it is tilted or at an angle.
- ❑ Avoid places subject to rapid changes in temperature and humidity. Also keep it away from direct sunlight, strong light, or heat sources.
- ❑ Avoid places subject to shocks and vibrations.
- ❑ Keep this product away from dusty areas.
- ❑ Place this product near a wall outlet where the plug can be easily unplugged.

When setting up this product

- ❑ Do not block or cover the openings in this product's cabinet.
- ❑ Do not insert objects through the slots. Take care not to spill liquid on this product.
- ❑ This product's power cord is for use with this product only. Use with other equipment may result in fire or electric shock.
- ❑ Connect all equipment to properly grounded power outlets. Avoid using outlets on the same circuit as copiers or air control systems that regularly switch on and off.
- ❑ Avoid electrical outlets controlled by wall switches or automatic timers.

- ❑ Keep the entire computer system away from potential sources of electromagnetic interference, such as loudspeakers or the base units of cordless telephones.
- ❑ Use only the type of power source indicated on the product's label.
- ❑ Use only the power cord that comes with this product. Use of another cord may result in fire or electric shock.
- ❑ Do not use a damaged or frayed power cord.
- ❑ If you use an extension cord with this product, make sure the total ampere rating of the devices plugged into the extension cord does not exceed the cord's ampere rating. Also, make sure the total ampere rating of all devices plugged into the wall outlet does not exceed the wall outlet's ampere rating.
- ❑ Do not attempt to service this product yourself.
- ❑ Unplug this product and refer servicing to qualified service personnel under the following conditions:

The power cord or plug is damaged; liquid has entered the product; the product has been dropped or the cabinet damaged; the product does not operate normally or exhibits a distinct change in performance.

- ❑ If you plan to use the printer in Germany, observe the following:

To provide adequate short-circuit protection and over-current protection for this printer, the building installation must be protected by a 10 or 16 amp circuit breaker.

- ❑ If damage occurs to the plug, replace the cord set or consult a qualified electrician. If there are fuses in the plug, make sure you replace them with fuses of the correct size and rating.

When using this product

- ❑ Do not put your hand inside this product or touch the ink cartridges during printing.
- ❑ Do not move the print heads by hand; otherwise you may damage this product.

Introduction



- ❑ Always turn the product off using the Power button on the control panel. When this button is pressed, the Power light flashes briefly then goes off. Do not unplug the power cord or turn off the product until the Power light stops flashing.

When handling the ink cartridges

- ❑ Keep ink cartridges out of the reach of children and do not drink.
- ❑ If ink gets on your skin, wash it off with soap and water. If it gets in your eyes, flush them immediately with water.
- ❑ Before installing the new ink cartridge in the printer, shake it back and forth horizontally in five centimeter movements about 15 times within five seconds.
- ❑ Use the ink cartridge before the date printed on its package.
- ❑ Use up the ink cartridge within a year of installation for best results.
- ❑ Do not dismantle the ink cartridges or try to refill them. This could damage the print head.
- ❑ Do not touch the IC chip on the side of the cartridge. This may affect normal operation and printing.
- ❑ The IC chip on this ink cartridge retains a variety of cartridge-related information, such as the ink cartridge status, so that the cartridge may be removed and reinserted freely. However, each time the cartridge is inserted, some ink is consumed because the printer automatically performs a reliability check.
- ❑ If you remove an ink cartridge for later use, protect the ink supply area from dirt and dust, and store it in the same environment as this product. Note that there is a valve in the ink supply port, making covers or plugs unnecessary, but care is needed to prevent the ink from staining items that the cartridge touches. Do not touch the ink supply port or surrounding area.

Note on this Guide

Meaning of Symbols

 Warning:	Warnings must be followed to avoid serious bodily injury.
 Caution:	Cautions must be followed to avoid damage to this product or bodily injury.
 Important:	Notes contain important information on the operation of this product.
Note:	Tips contain useful or additional information on the operation of this product.

Illustrations

Unless otherwise noted, the illustrations in this documentation show the SC-T7200 Series.

Operating System Versions

In this documentation, the following abbreviations are used.

Windows refers to Windows 10, 8.1, 8, 7, Vista, XP.

- ❑ Windows 10 refers to Windows 10 Home, Windows 10 Pro, Windows 10 Enterprise and Windows 10 Education.
- ❑ Windows 8.1 refers to Windows 8.1, Windows 8.1 Pro, and Windows 8.1 Enterprise.
- ❑ Windows 8 refers to Windows 8, Windows 8 Pro, and Windows 8 Enterprise.
- ❑ Windows 7 refers to Windows 7 Home Basic, Windows 7 Home Premium, Windows 7 Professional, and Windows 7 Ultimate.

Introduction

- ❑ Windows Vista refers to Windows Vista Home Basic Edition, Windows Vista Home Premium Edition, Windows Vista Business Edition, Windows Vista Enterprise Edition, and Windows Vista Ultimate Edition.
- ❑ Windows XP refers to Windows XP Home Edition, Windows XP Professional x64 Edition, and Windows XP Professional.
- ❑ Windows Server 2012 refers to Windows Server 2012 Essentials Edition, Server 2012 standard Edition.
- ❑ Windows Server 2008 refers to Windows Server 2008 Standard Edition and Windows Server 2008 Enterprise Edition.
- ❑ Windows Server 2008 x64 refers to Windows Server 2008 x64 Standard Edition, Windows Server 2008 x64 Enterprise Edition, Windows Server 2008 R2 Standard Edition, and Windows Server 2008 R2 Enterprise Edition.
- ❑ Windows Server 2003 refers to Windows Server 2003 Standard Edition and Windows Server 2003 Enterprise Edition.
- ❑ Windows Server 2003 x64 refers to Windows Server 2003 x64 Standard Edition and Windows Server 2003 x64 Enterprise Edition.

Macintosh refers to Mac OS X.

- ❑ Mac OS X refers to Mac OS X 10.5.8 and later versions.

Introduction

Printer Parts

Front

The illustration shows the SC-T7200 Series. The operation is the same even when the shape of the paper basket or other items are different.

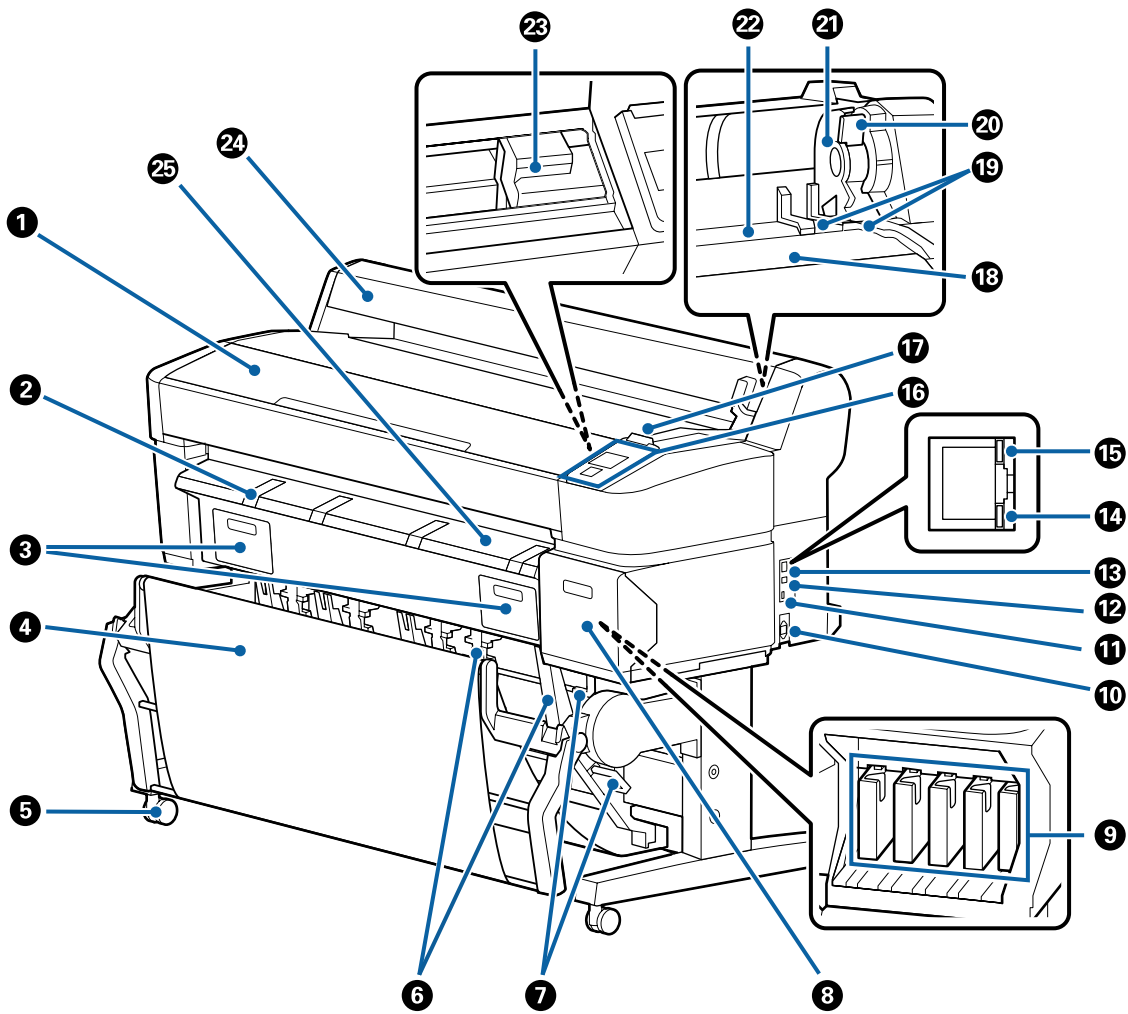

1 Printer cover

Open this cover when cleaning the printer or clearing jams.

2 Poster board support

Raise this support so that you can place the media on it when printing on poster board. The support ensures that poster board feeds smoothly.

 [“Loading and Removing Poster Board” on page 41](#)

Introduction

3 Maintenance box covers

Open these covers when replacing the Maintenance Box.

Some models have only the right cover.

 [“Replacing Maintenance Boxes” on page 186](#)

4 Paper basket/Large-capacity paper basket

Output from the printer collects in this basket, keeping the media clean and free of creases.

The optional Stand (24) for the SC-T3200 Series comes with a paper basket.

 [“Using the Paper Basket \(SC-T7200 Series/SC-T5200 Series/SC-T3200 Series\)” on page 47](#)

 [“Using the Large-Capacity Paper Basket \(SC-T7200D Series/SC-T5200D Series\)” on page 51](#)

5 Casters

There are two casters on each leg. The casters are normally kept locked once the printer is in place.

6 Stack guides

(SC-T7200 Series/SC-T5200 Series/SC-T3200 Series only)

Select a guide according to the size of the media output to the paper basket.

 [“Using the Paper Basket \(SC-T7200 Series/SC-T5200 Series/SC-T3200 Series\)” on page 47](#)

7 Stack guide switch lever

(SC-T7200 Series/SC-T5200 Series/SC-T3200 Series only)

Use to choose a stack guide.

8 Cartridge cover

Open when replacing ink cartridges.

 [“Replacing Ink Cartridges” on page 185](#)

9 Ink cartridges

Install all ink cartridges into each slot.

10 AC inlet

Connect the supplied power cable here.

11 Option port

Use when connecting the options such as MFP Scanner.

12 USB port

Use when connecting to a computer using a USB cable.

13 LAN port

Connects the LAN cable.

14 Data light

The network connection status and data reception are indicated by a lit or flashing light.

On : Connected.

Flashing : Receiving data.

Introduction

15 Status light

The color indicates the network transmission speed.

Off : 10Base-T

Red : 100Base-T

Green : 1000Base-T

16 Control panel

 [“Control panel” on page 14](#)

17 Alert lamp

This lamp lights or flashes when an error occurs.

Lights or flashes : An error occurred. How the lamp lights or flashes varies with the type of error. The control panel displays a description of the error.

Off : No error.

18 Roll rest

When loading roll paper, place it on this rest and attach the roll paper adapters.

 [“Attaching the Roll Paper Adapter” on page 29](#)

19 Adapter guides

Guides for attaching roll paper. Move the roll along these guides to attach it to the adapter holder.

 [“Attaching the Roll Paper Adapter” on page 29](#)

20 Roll lock lever

A lever that locks roll paper in place after the roll is attached to the adapter holder.

21 Adapter holder

The roll paper adapter is placed in this holder after the roll paper is attached.

22 Paper slot

The slot through which roll paper and single sheets are fed during printing.

Feed single sheets one at a time.

23 Print head

Fires ink via high density nozzles while moving left and right to print.

24 Roll paper cover

Cover to protect the roll paper. Except when loading or removing roll paper, it should be closed when using the printer.

25 Paper eject guide

Guides paper output from the printer smoothly into the paper basket.

Introduction

Back

The illustration shows the SC-T7200D Series.

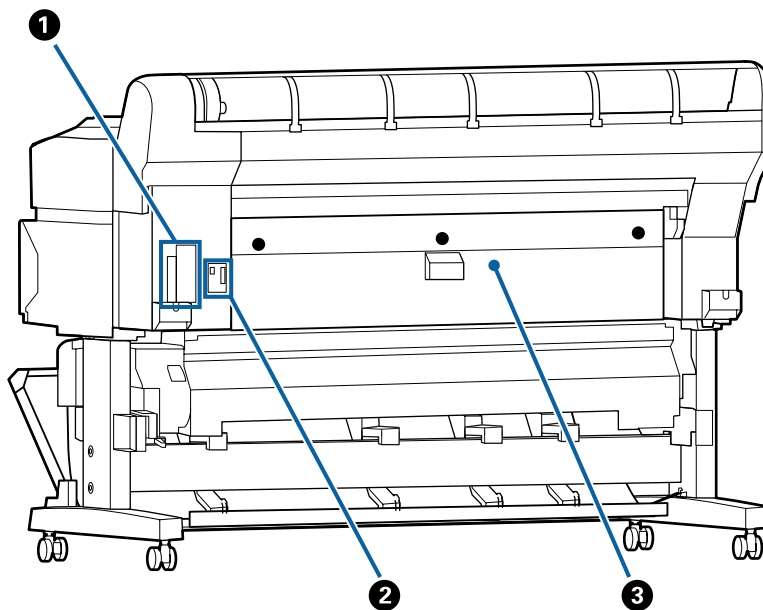

1 Option slot

Slot to connect the optional hard disk unit or Adobe PostScript 3 Expansion Unit.

**2 Roll 2 unit connector
(SC-T7200D Series/SC-T5200D Series only)**

Connect the connection cable of the Roll 2 unit.

Normally the cable is connected when using the printer.

**3 Rear cover
(SC-T7200D Series/SC-T5200D Series only)**

When roll paper loaded to the Roll 2 unit is jammed, open the cover, and then remove the jammed paper.

Normally closed when using the printer.

 [“Roll paper jam” on page 204](#)

Introduction

**Roll 2 unit (SC-T7200D Series/
SC-T5200D Series)**

The illustration shows the SC-T7200D Series.

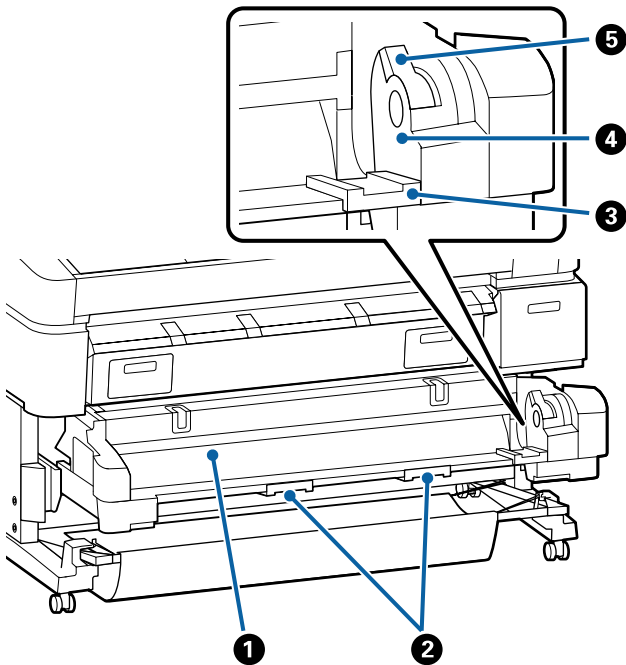

1 Paper slot

Insertion slot to feed roll paper.

[“Loading Roll 2\(SC-T7200D Series/SC-T5200D Series only\)” on page 33](#)

2 Drawer handles

When you load or remove roll paper, hold these handles and pull out or push in the Roll 2 unit.

[“Loading Roll 2\(SC-T7200D Series/SC-T5200D Series only\)” on page 33](#)

3 Adapter guides

Move the roll paper adapter loaded with a roll along these guides to attach it to the adapter holder.

[“Loading Roll 2\(SC-T7200D Series/SC-T5200D Series only\)” on page 33](#)

4 Adapter holder

The roll paper adapter is placed in this holder after the roll paper is attached.

5 Roll lock lever

A lever that locks roll paper in place after the roll is attached to the adapter holder.

Roll paper adapter

Use the supplied roll paper adapter when loading roll paper onto the printer.

[“Attaching the Roll Paper Adapter” on page 29](#)

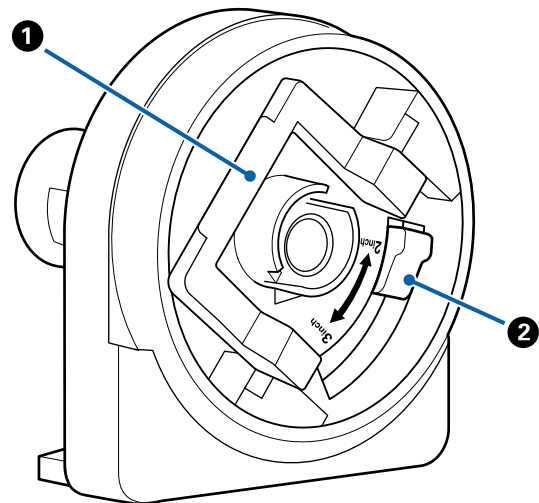

1 Adapter lock lever

Lift to unlock, lower to lock. Unlock when attaching roll paper to the adapter, lock once the roll is attached.

2 Size lever

Position according to the size of the roll core.

Introduction

Control panel

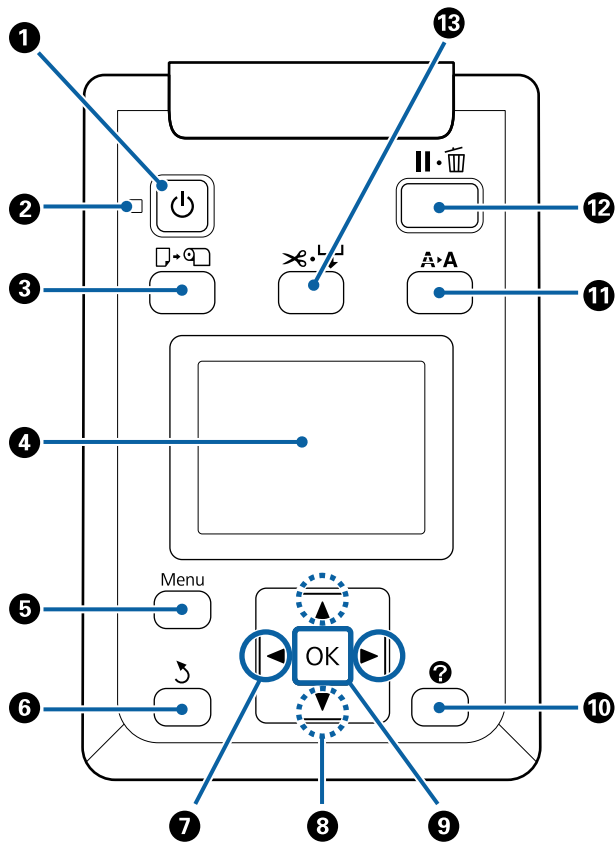

- 1 Power button (power button)**
Turns the power on and off.
- 2 Power light (power light)**
The printer's operational status is indicated by a lit or flashing light.

On : The power is on.

Flashing : The printer is receiving data or cleaning the print head or performing other operations in the course of being shut down.

Off : The power is off.
- 3 Load/Remove Paper button (Load/Remove Paper button)**
Pressing this button displays the Load/Remove Paper menu. Instructions for loading or removing the paper can be displayed by highlighting either **Remove Paper** or the type of paper currently loaded and then pressing the OK button. Follow the on-screen instructions to load or remove the paper.

- 4 Screen**
Displays the printer's status, menus, error messages, and so on. [Screen View](#) on page 15
- 5 Menu button**
Displays the menu for the tab currently selected in the display. (Excluding the **+** and **-** tabs.)

[Using the Control Panel Menu](#) on page 136
- 6 Back button (back button)**
If menus are displayed, pressing this button takes you up one level in the menu hierarchy. [Menu Operations](#) on page 136
- 7 Left and right arrow buttons (left and right arrow buttons)**
 - Use these buttons to select tabs. The selected tab is highlighted and the content of the info display area is updated for the selected tab.
[Screen View](#) on page 15
 - If menus are displayed, these buttons can be used to position the cursor or delete characters when entering text for items such as **Setting Name** or **IP Address**.
- 8 Up/Down buttons (Up/Down buttons)**
When menus are displayed, these buttons can be used to highlight items or options. [Menu Operations](#) on page 136
- 9 OK button**
 - Displays the menu for the tab currently selected in the display.
[Using the Control Panel Menu](#) on page 136
 - When menus are displayed and an item is highlighted, pressing this button displays the sub-menu for the highlighted item.
 - If pressed while a parameter is selected from the Menu, the parameter is set or executed.
- 10 Help button (Help button)**
Except when printing is in progress, pressing this button displays the Help menu. Highlight an item and press the OK button to view help for the highlighted item.
- 11 Maintenance button (Maintenance button)**

Introduction

Displays the Maintenance menu, which is used for nozzle checks and head cleaning.

[“Adjusting the Print Head” on page 179](#)

12 button (pause/cancel button)

- The printer enters pause status if this is pressed while printing. To release the pause status, press the button again, or select **Pause Cancel** on the screen and then press the OK button. To cancel print jobs being processed, select **Job Cancel** on the screen and then press the OK button.
- Pressing this button while a menu or help is displayed closes the menu or help and returns the printer to ready status.

13 button (Feed/Cut Media button)

- This button is used with roll paper only. If the printer is loaded with cut sheets or poster board, pressing this button will have no effect.
- It is used to manually cut roll paper using the built-in cutter.
- If printing is not currently in progress and the printer is loaded with roll paper, you can feed paper ahead by pressing first this button and then the button. Press the button to rewind. Keep the button pressed to feed the paper up to 3 m. Keep the button pressed to rewind the paper up to 20 cm.

When the button is used to rewind roll paper, the paper will pause when the end of the roll reaches the starting print position. Release the button and then press it again to resume.

Screen View

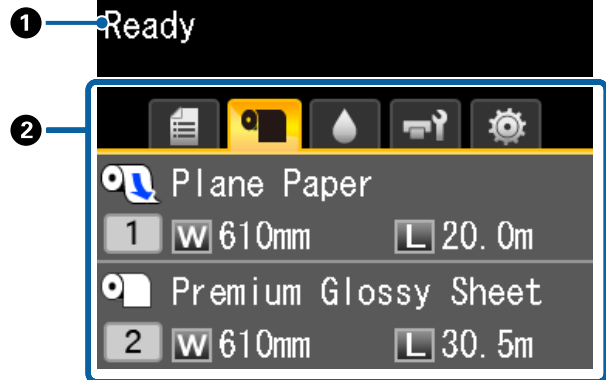
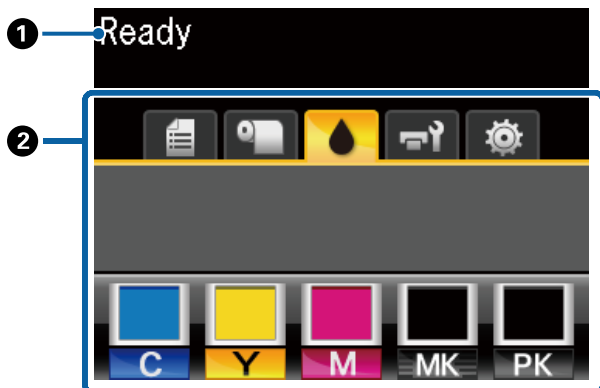

1 Messages

Displays the printer's status, operation, and error messages.

[“What to do When a Message is Displayed” on page 193](#)

2 Tabs/Info Display Area

The tab/info display area contains the seven tabs listed below.

Use the buttons to select a tab.

Information on the selected tab appears in the info display area.

Scan File Options Tab

Tab appears only when the optional hard disk unit or Adobe PostScript 3 Expansion Unit (hereinafter referred to as the hard disk) is installed.

Scan file operations are done as shown below.

- Receiving scanned files sent from the printer on which is installed the optional MFP scanner.
- Printing and forwarding of scanned files saved to the hard disk.

[“Operations for Image Files that were Scanned or Received” on page 81](#)

Introduction

: The Large Copy Tab

This tab is displayed only when the optional MFP scanner is installed.

In this tab, select a job you want to do, and then press the OK button. When the optional hard disk unit or Adobe PostScript 3 Expansion Unit is installed, you can also use the scan function.

 [“Large Copying and Large Scanning using the MFP Scanner \(Option\)” on page 73](#)

: The Print Queues Tab

Print job information appears in the info display area.

When you press the Menu button, the Print Queues menu appears.

 [“Print Queues menu” on page 147](#)

The Info Display Area

The name of the job being printed appears when the printer driver is used.

If an optional hard disk unit or Adobe PostScript 3 Expansion Unit is installed, it also shows the number of held jobs, if any.

Important:

A flashing  icon indicates that an optional hard disk unit or Adobe PostScript 3 Expansion Unit is transmitting data to the printer. Do not disconnect the power cord or turn the printer off while the icon is flashing. Failure to observe this precaution could corrupt the data on the hard disk unit or Adobe PostScript 3 Expansion Unit.

: The Paper Tab

The information of loaded paper appears in the info display area.

When you press the Menu button, the Paper menu appears.

 [“Paper menu” on page 149](#)

The Info Display Area

Displays the Source and Media Type of the loaded paper.

When roll paper is used, it also shows the roll width. When **Roll Paper Remaining** is **On**, it shows the amount of roll paper remaining. When the length remaining reaches or falls below the value selected for **Remaining Alert**, a  icon appears above the tab icon and an alert like that shown below is displayed to warn that the printer is nearing the end of the roll.



When roll paper is loaded on Roll 1/Roll 2 of the SC-T7200D Series/SC-T5200D Series, you can check which is selected (in use) by looking at the icon.



: Indicates a roll that is selected (in use).

The number indicates either Roll 1 or Roll 2.



: Indicates a roll in a standby state.

If there is an automatic switching command, this roll is selected for printing.

Automatic switching of roll paper  [“Switching Roll Paper Automatically before Printing \(SC-T7200D Series/SC-T5200D Series Only\)” on page 97](#)

Introduction

 **The Ink Tab**
Shows ink cartridge status in the info display area.

The Info Display Area

As shown in the following illustrations, the icon changes based on the status of the ink cartridge.

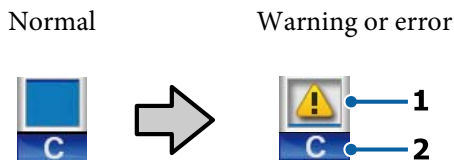

1 Status indicators

: No error. The height of the indicator changes with the level of ink remaining.

: Ink is low. You need to prepare a new ink cartridge.

: Ink cartridge is expended; replace with a new ink cartridge.

: An error occurred. Check the message on the screen, and clear the error.

2 Ink color codes

C : Cyan

Y : Yellow

M : Magenta

MK : Matte Black

PK : Photo Black

 **The Maintenance Tab**
Displays Maintenance Box status in the info display area.

When you press the Menu button, the Maintenance menu appears.

 [“Maintenance menu” on page 153](#)

The Info Display Area

As shown in the following illustrations, the icon changes based on the status of the Maintenance Box.



1 Status indicators

: No error. The height of the indicator corresponds to the amount of space remaining.

: The Maintenance Box is nearing the end of its service life. You need to prepare a new Maintenance Box.

: Maintenance Box is at the end of its service life. Replace the Maintenance Box with a new one.

 **The Setup Tab**
Shows the specified IP address in the info display area.

When you press the Menu button, the Setup menu appears.

 [“Setup menu” on page 154](#)

Introduction

The Enlarged Copy Tab

The enlarged copy tab is displayed only when a scanner is connected.

Pressing the OK button when this tab is selected displays the Enlarged Copy screen.

 [“Enlarged Copy menu” on page 173](#)

Features

The main features of this printer are described below.

Realizing High Productivity

High-speed printing

The speeds of the print head and paper feed have been increased for faster printing.

The printer is equipped with a high-speed rotary cutter for quick cutting, significantly increasing productivity.

Paper basket holds consecutive sheets (SC-T7200 Series/SC-T5200 Series/SC-T3200 Series)

The paper basket accommodates up to 20 sheets of A2/A1/A0/ARCH D/US D/US E plain paper, promoting automation for improved productivity.

The optional Stand (24) for the SC-T3200 Series comes with a paper basket.

 [“Using the Paper Basket \(SC-T7200 Series/SC-T5200 Series/SC-T3200 Series\)” on page 47](#)

Large-capacity paper basket which can continually accommodate various mixed paper sizes (SC-T7200D Series/SC-T5200D Series)

This basket can hold various mixed paper sizes from A1 Landscape size and smaller.

In addition, if you set the basket to the compact position, you can reduce the protrusion of the paper basket so it can be used even in narrow spaces.

 [“Using the Large-Capacity Paper Basket \(SC-T7200D Series/SC-T5200D Series\)” on page 51](#)

Improved operability with an easy to see and use color screen

Designed for intuitive operation, the large, brightly-lit, color LCD display is easy to understand and easy to use.

The large display offers detailed, easy-to-understand error messages and illustrated guides to loading paper.

 [“Screen View” on page 15](#)

Introduction

Checking current operating status even from afar thanks to an alert lamp

Errors are immediately obvious even at a distance, thanks to the large, highly visible alert lamp. This helps prevent any wasted time when printing has stopped due to running out of ink or paper.

Loading two roll papers and increasing productivity (SC-T7200D Series/SC-T5200D Series)

You can load roll paper at two locations, Roll 1 (upper section) and Roll 2 (lower section). This feature increases productivity in the following manner.

- ❑ Because you can load different types of roll paper in Roll 1 and Roll 2, specify the media type on the printer driver during printing, and switch printing between Roll 1 and Roll 2, you do not need to reset the paper every time you change the media type.

 [“Switching to Roll 1/Roll 2 by Paper Type” on page 97](#)

- ❑ If you load different sizes of roll paper in Roll 1 and Roll 2 in advance, the printer switches to the roll paper with the smaller margin during printing automatically in accordance with the document size of the print job. This feature makes it easy to conserve paper.  [“Switching to Roll 1/Roll 2 by Document Size” on page 98](#)

- ❑ If you load the same types and sizes of roll paper in Roll 1 and Roll 2 in advance, and the printer predicts during printing that the roll paper remaining is shorter than the print length, it switches to the roll paper that is longer than the print length automatically and continues printing. This feature allows continuous unattended operation.

 [“Switching to the Roll with the Most Paper Remaining \(Roll 1/Roll 2\) before Printing if the Paper Runs Out” on page 100](#)

Realizing High Resolution

Thanks to newly developed Epson UltraChrome XD Ink technology, the printer can be used for high-quality posters and CAD drawings.

CAD drawings: clear, legible, and with unsurpassed water resistance

Newly-developed, high-density Matte Black ink enables the printer to produce extremely detailed drawings.

Pigmented inks are used for all colors for unsurpassed water resistance, allowing print results to be safely carried out-of-doors.*1

The printer driver offers a line drawing mode, making it easier to optimize printing for line drawing and, through unsurpassed reproduction of line drawing and fine lines in the form of connected lines, diagonals, and curves, ensuring the best possible results when the printer is used for drawings.

Vivid, highly lightfast posters and displays*2

Our new magenta ink improves the reds so important to posters, making them even more noticeable.

The printer driver offers a poster mode that simplifies the printing of vivid posters. Posters with vivid hues can be printed simply by selecting poster mode.

Thanks to the pigmented inks used for all colors, the results are highly water-resistant and can be used for short-term outdoor display. They are also extremely lightfast and fade-resistant and can be safely displayed in direct sunlight.

*1 When you are printing for outdoor use, use lamination processing.

*2 It is not possible to obtain the same results for all paper.

Insistence on Ease-of-Use

Spindle-free roll paper adapter makes loading roll paper a snap

The lack of a spindle makes it possible to load and remove roll paper even in environments where space is at a premium.

To load roll paper, simply place it on the roll rest and attach roll paper adapters to both ends. The roll rest is low, making it easy even for short workers to load paper.

 [“Attaching the Roll Paper Adapter” on page 29](#)

Ease of Maintenance

Roll paper and all replacements, including ink cartridges, Maintenance Boxes, and cutters, are installed from the front, allowing the printer to be placed against a wall. The printer does not have to be moved to allow rear access.

Introduction

Choose from three sizes of cartridge according to the task

Choose from 110, 350, and 700 ml cartridges according to the frequency with which the printer is used. Use cost-effective 700 ml cartridges for high-volume poster printing or select individual 110 or 350 ml cartridges for monochrome printing.

New printer driver offers greatly improved ease-of-use

Print settings can be optimized simply by choosing the desired use or target. This spares you the trouble of adjusting print settings individually.

On startup, the printer driver automatically checks the status of the paper loaded in the printer and displays it in the **Media Settings** dialog box, preventing errors caused by failure to check paper status before printing.

The printer driver displays printer settings graphically, reducing errors caused by inappropriate choices of settings.

MFP Scanner that can be integrated and installed with the printer

You can connect the optional MFP Scanner to the top of the printer when you use the dedicated stand. This feature reduces the installation space and allows you to load documents and print copies at one location.

Furthermore, this feature provides a stress-free workflow because printing starts at high speed after copying.

[“Large Copying and Large Scanning using the MFP Scanner \(Option\)” on page 73](#)

Notes on Usage and Storage

Installation space

Make sure that you secure the following space, clear of any other objects, so that paper ejection and consumable replacement are not obstructed.

See the “Specifications Table” for the external dimensions of the printer.

[“Specifications Table” on page 226](#)

* When printing on poster board, ensure that there is sufficient space both in front of and behind the printer.

[“Loading and Removing Poster Board” on page 41](#)

SC-T7200 Series/SC-T5200 Series

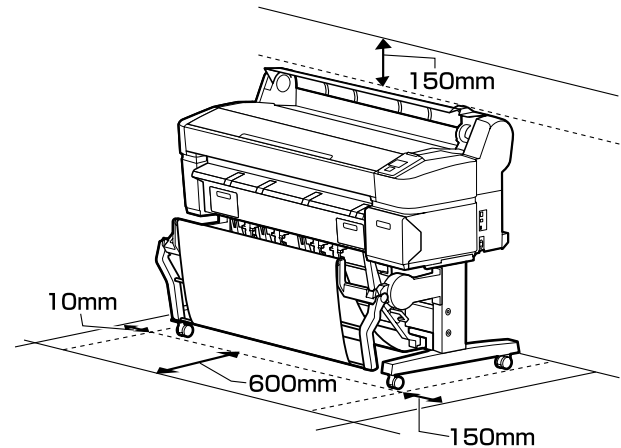

SC-T3200 Series

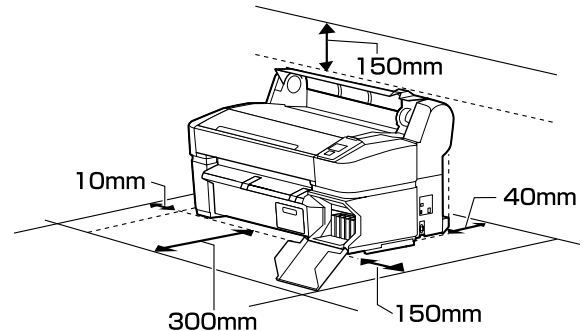

Introduction

SC-T7200D Series/SC-T5200D Series

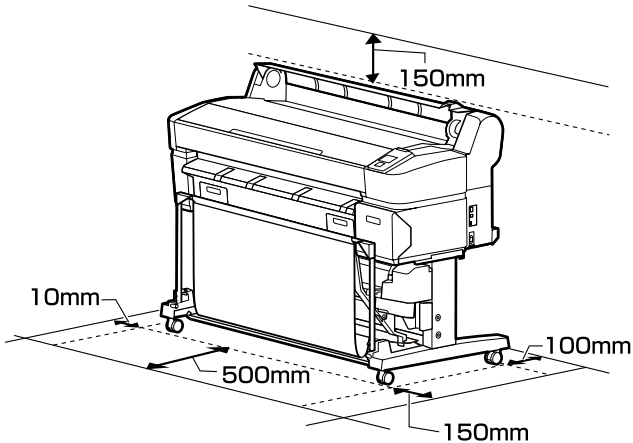

When the MFP Scanner is installed

The following illustration shows the installation space when the dedicated stand is used to attach the MFP Scanner.

- * When the thickness of the document to be loaded is 0.25 mm or larger, ensure that there is sufficient space both in front of and behind the printer.

“When you load a document that is more than 0.25 mm thick” on page 76

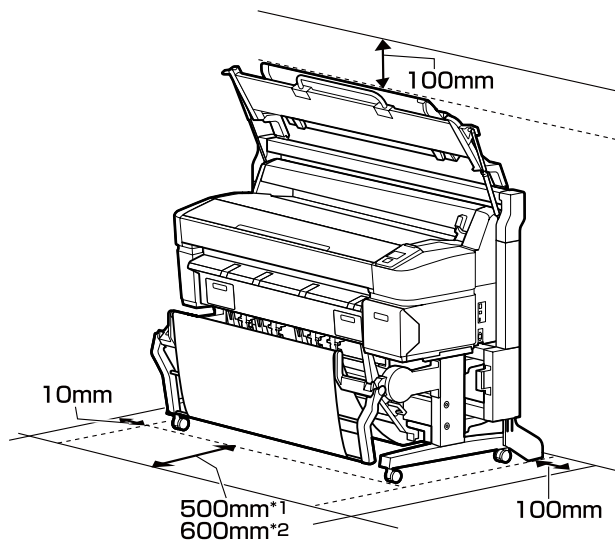

*1 For SC-T7200D Series/SC-T5200D Series

*2 For SC-T7200 Series/SC-T5200 Series/SC-T3200 Series

Notes when using the printer

Note the following points when using this printer to avoid breakdowns, malfunctions, and print quality decline.

- ❑ When using the printer, observe the operating temperature and humidity range described in the "Specifications Table". “Specifications Table” on page 226

Even when the conditions above are met, you may not be able to print properly if the environmental conditions are not suitable for the paper. Be sure to use the printer in an environment where the paper's requirements are met. For more details, see the documentation supplied with the paper.

Also, when operating in dry areas, air conditioned environment, or under direct sunlight, maintain the appropriate humidity.

- ❑ Do not install the printer next to heat sources or directly in the path of air from a ventilator or air conditioner. Failure to observe this precaution could result in the print head nozzles drying and clogging.
- ❑ The print head may not be capped (i.e., may not move to the right-hand side) if an error occurs and the printer is turned off without first resolving the error. Capping is a function for automatically covering the print head with a cap (lid) to prevent the print head from drying out. In this case, turn on the power and wait a while until capping is performed automatically.
- ❑ When the power is on, do not remove the power plug or cut the power at the breaker. The print head may not be capped properly. In this case, turn on the power and wait a while until capping is performed automatically.
- ❑ Even when the printer is not in use, some ink will be consumed by head cleaning and other maintenance operations needed to keep the print head in good condition.

Notes when not using the printer

If you are not using it, note the following points when storing the printer. If it is not stored correctly, you may not be able to print properly the next time it is used.

Introduction

- ❑ If you do not print for a long time, the print head nozzles may become clogged. We recommend that you print once a week to prevent the print head from clogging.
- ❑ The roller may leave an impression on paper that is left in the printer. This can also cause wavy or curled paper resulting in paper feeding problems or the print head could be scratched. Remove any paper when storing.
- ❑ Store the printer after confirming that the print head has been capped (the print head is positioned at the far right). If the print head is left uncapped for a long time, the print quality may decline.

Note:

If the print head is not capped, turn the printer on, and then turn it off.

- ❑ To prevent the accumulation of dust and other foreign matter in the printer, close all covers before placing it in storage.

If the printer will not be used for an extended period, protect it with an anti-static cloth or other cover.

The print head nozzles are very small, and they can become clogged easily if fine dust gets on the print head, and you may not be able to print properly.

- ❑ When turned on after an extended period of disuse, the printer may automatically perform head cleaning to ensure print quality.

Head cleaning will end after about 10 to 15 minutes.

Notes on handling ink cartridges

Note the following points when handling ink cartridges to maintain good print quality.

- ❑ The supplied ink cartridges and Maintenance Box are for use during the initial charging. The supplied ink cartridges and Maintenance Box will be required for replacement relatively quickly.
- ❑ We recommend that ink cartridges be stored at room temperature out of direct sunlight and used before the expiry date printed on the packaging.

- ❑ To ensure good results, use all the ink in the cartridge within a year of installation.
- ❑ Ink cartridges that have been stored at low temperatures for an extended period should be allowed to return to room temperature over a period of four hours.
- ❑ Do not touch the IC chips on the ink cartridges. You may not be able to print properly.
- ❑ Install all ink cartridges into each slot. You cannot print if any of the slots are empty.
- ❑ Do not leave the printer without ink cartridges installed. The ink in the printer may dry, preventing it from printing as expected. Leave ink cartridges in all slots even while you do not use the printer.
- ❑ The ink level and other data are stored in the IC chip, allowing cartridges to be used after being removed and replaced.
- ❑ To avoid getting dirt on the ink supply port, store the removed ink cartridge properly. The ink supply port has a valve in it so it does not need to be capped.
- ❑ Removed ink cartridges may have ink around the ink supply port, so be careful not to get any ink on the surrounding area when removing the cartridges.
- ❑ To maintain the quality of the print head, this printer stops printing before ink cartridges are completely expended.
- ❑ Although the ink cartridges may contain recycled materials, this does not affect printer function or performance.
- ❑ Do not dismantle or remodel ink cartridges. You may not be able to print properly.
- ❑ Do not drop or knock ink cartridges against hard objects; otherwise, the ink may leak.

Notes on handling paper

Note the following points when handling and storing the paper. If the paper is not in good condition, print quality may decline.

Check the documentation supplied with each paper.

Introduction

Notes on Handling

- ❑ Use Epson special media under normal room conditions (temperature: 15 to 25°C, humidity: 40 to 60%).
- ❑ Do not fold the paper or scratch the surface of the paper.
- ❑ Avoid touching the printable surface of the paper with your bare hands. Moisture and oils from your hands can affect print quality.
- ❑ Handle paper by the edges. We recommend wearing cotton gloves.
- ❑ Changes in temperature and humidity may cause paper to become wavy or curled. Be careful not to scratch or soil the paper, and flatten it before loading it in the printer.
- ❑ Do not wet the paper.
- ❑ Do not throw away the paper packaging as you can use it for storing the paper.
- ❑ Avoid locations that are subject to direct sunlight, excessive heat, or humidity.
- ❑ Keep cut sheets in their original package after opening, and keep them in a flat place.
- ❑ Remove roll paper that is not in use from the printer. Rewind it correctly and then store it in the original packaging that came with the roll paper. If you leave the roll paper in the printer for a long time, its quality may decline.

Notes on handling printed paper

To maintain long lasting, high quality print results, note the following points.

- ❑ Do not rub or scratch the printed surface. If they are rubbed or scratched, the ink may peel off.
- ❑ Do not touch the printed surface; Failure to observe this precaution may cause ink to rub off.
- ❑ Make sure the print outs are completely dry before folding or stacking; otherwise, the color may change where they touch (leaves a mark). These marks will disappear if they are separated immediately and dried; however, they will remain if not separated.

- ❑ If you put the print outs in an album before they are completely dry, they may be blurred.
- ❑ Do not use a dryer to dry the print outs.
- ❑ Avoid direct sunlight.
- ❑ Prevent color distortion while displaying or storing the print outs by following the instructions in the paper's documentation.

Note:

Typically, print outs and photos fade over time (color distortion) due to the effects of light and various constituents in the air. This also applies to Epson special media. However, with the correct storage method, the degree of color distortion can be minimized.

- ❑ *See the documentation supplied with Epson special media for detailed information on handling the paper after printing.*
- ❑ *The colors of photos, posters, and other printed materials appear different under different lighting conditions (light sources^{*}). The colors of print outs from this printer may also appear different under different light sources.*

** Light sources include sunlight, fluorescent light, incandescent light, and other types.*

Introduction

Introducing the Supplied Software

The software that can be used on the printer is provided in the following two ways.

- ❑ Stored on the software disc that is provided

See the following section for descriptions of the software that has been stored.

- ❑ Installed on the printer

You can start it from a web browser via a network.

See the following for descriptions of the software that has been installed.

 [“Overview of software installed on the printer” on page 25](#)

Contents of the Software Disc

The supplied Software Disc contains the following software. Install as required.

More information can be found in the *Network Guide* (pdf) or via online help for the application in question.



Important:

The software is updated as needed for greater convenience and more robust functionality. Check the Epson website for the latest version.

<https://www.epson.com>

For Windows

Software Name	Summary
Epson Driver and Utilities	<p>The following software is installed.</p> <p>Printer Driver The printer driver is required when using the printer. It can be installed by selecting Install during setup.  “Summary of the Printer Driver” on page 26</p> <p>EPSON LFP Remote Panel 2 This software is used for custom paper settings and other configurations.</p>
Epson Network Utilities	<p>Select this option during installation if the printer and computer are connected via a network. Installing this utility allows a wizard to be used to simplify the process of setting the addresses needed for network connections.</p> <p>EpsonNet Print is also installed. With EpsonNet Print, you can perform direct TCP/IP printing when the computer and the printer are connected via a network.</p>
EpsonNet Config	<p>With this software, you can configure various network settings for the printer from your computer. This is useful as it allows you to enter addresses and names using the keyboard.</p> <p>The manual is also installed along with the software.</p>

Introduction

Software Name	Summary
LFP Print Plug-In for Office	<p>This is a plug-in for Microsoft Office applications (Word, Excel, and PowerPoint). Installing this plug-in displays a ribbon in Office applications that gives quick access to horizontal and vertical banner printing and enlarged printing.</p> <p>Before installing the plug-in, check the following.</p> <ul style="list-style-type: none"> <input type="checkbox"/> Office 2003, Office 2007, Office 2010 or Office 2013 is installed. <input type="checkbox"/> None of these applications (Office 2003, Office 2007, Office 2010 or Office 2013) is running. <p>This plug-in is not included in some regions.</p>

For Mac OS X

Software Name	Summary
Epson Driver and Utilities	<p>The following software is installed.</p> <p>Printer Driver The printer driver is required when using the printer. It can be installed by selecting Install during setup. ☞ "Summary of the Printer Driver" on page 26</p> <p>EPSON LFP Remote Panel 2 This software is used for custom paper settings and other configurations.</p>
Epson Network Utilities	<p>Select this option during installation if the printer and computer are connected via a network. Installing this utility allows a wizard to be used to simplify the process of setting the addresses needed for network connections.</p>
EpsonNet Config	<p>With this software, you can configure various network settings for the printer from your computer. This is useful as it allows you to enter addresses and names using the keyboard. The manual is also installed along with the software.</p>

Overview of software installed on the printer

Software Name	Summary
Remote Manager	<p>Use this software to check the status of the printer, and to do network and security settings.</p> <p>In addition, you can operate print jobs that have been saved to the optional hard disk unit or the Adobe PostScript 3 Expansion Unit. ☞ "Saving to and Reprinting on the Optional Hard Disk Unit" on page 69</p> <p>See the following for the procedure to start and use Remote Manager. ☞ "How to use Remote Manager" on page 27</p>
Copy Manager	<p>This software allows you to use the optional MFP scanner to do large copying and scanning.</p> <p>Start and use it from a tablet or other terminal so you can do the copy and scan settings on a large screen for better operability. See the online help for details about operating procedures.</p> <p>Starting Procedure ☞ "How to start Copy Manager" on page 74</p>

Introduction

Summary of the Printer Driver

The main functions of the printer driver are described below.

- ❑ Converts print data received from applications into printable data and sends it to the printer.
- ❑ Settings such as document size and print quality can be adjusted from the settings dialogs.

Windows

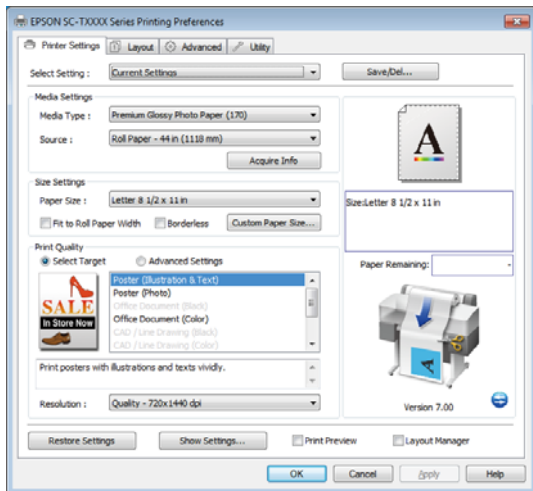

You can save these settings and easily import or export these saved settings.

[“Customizing the Printer Driver” on page 128](#)

Mac OS X

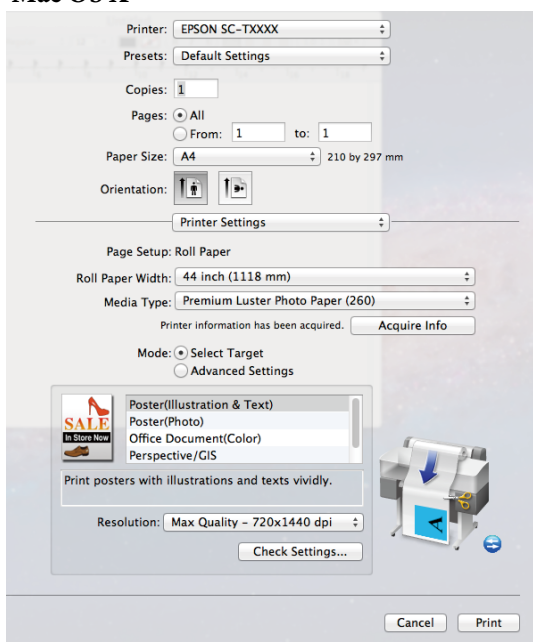

- ❑ Allows you to execute printer maintenance functions to maintain print quality, check the printer's status, and so on.

Windows

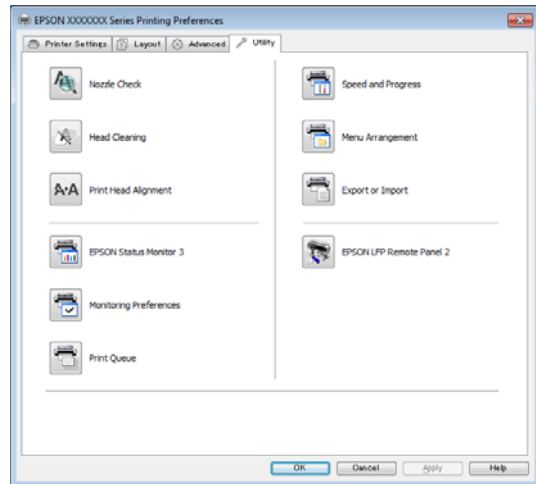

You can easily import or export printer driver settings.

[“Overview of the Utility Tab” on page 130](#)

Mac OS X

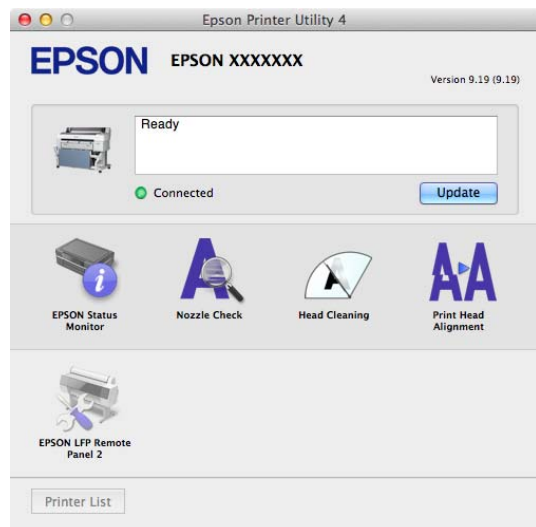

Introduction

How to use Remote Manager

Start and use the software from the web browser of a computer or tablet terminal that is connected to the printer via the network.

In addition to checking the printer's status and doing network settings, you can Upload And Print and Print From Folder.

Starting Procedure

- 1 Start a web browser on a tablet terminal or computer connected to the printer via the network.
- 2 Enter the IP address specified for the printer in the address bar, and then press the Enter key or the Return key.

If any of the following options is installed, proceed to step 3.

- MFP scanner
- Hard disk unit
- Adobe PostScript 3 expansion unit

If none are installed, Remote Manager starts.

- 3 In the screen that is displayed, click **Remote Manager**.

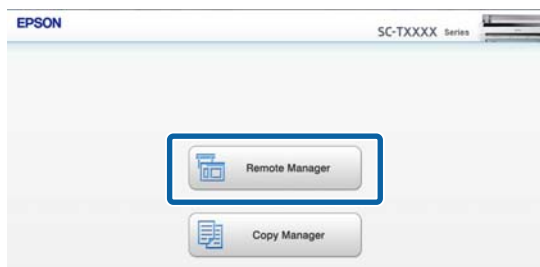

The printer does not have a wireless LAN function. To connect the printer and a tablet terminal over the network, you need a wireless LAN router or wireless LAN access point.

Example

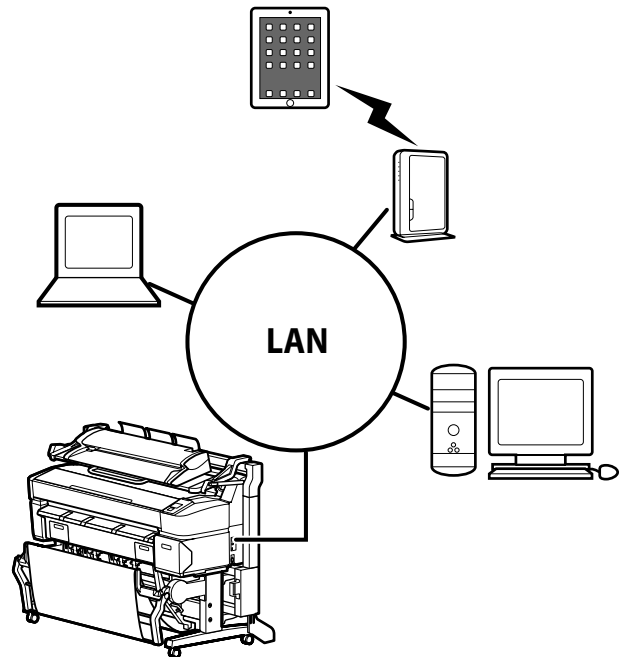

For supported operating systems and browsers, see the following section.

[🔗 “System Requirements” on page 225](#)

Overview of Upload And Print and Print From Folder

Upload And Print and Print From Folder are functions that start Remote Manager and to print from a computer or tablet terminal on which a printer driver is not installed.

Upload And Print

Just select the file you want to print and upload it to the printer to print it. If the browser you are using supports drag and drop, you can upload multiple files in a batch and print them in order.

Print From Folder

You can select a file in a shared folder that has been setup in advance and print it.

Supported files

The following files are supported by Upload And Print and Print From Folder. The supported files vary depending on whether or not the optional Adobe PostScript 3 expansion unit is installed.

Introduction

File formats	Not installed	Installed
HP-GL/2	✓	✓
HP RTL	✓	✓
PDF	-	✓
PostScript	-	✓
EPS	-	✓
TIFF	-	✓
JPEG	-	✓
CALS G4(type I)	-	✓

HP-GL/2 and HP RTL format files are printed according to the **HP-GL/2 Settings** in the printer's settings menu.

 [“Printer Setup” on page 154](#)

The other files are printed according to the settings in the **PS3 Expansion Unit** in the printer's settings menu.

 [“Option Setup^{*4}” on page 164](#)

See the online help for details about operations.

Basic Operations

Basic Operations

Loading and Removing the Roll Paper

Load roll paper after attaching the supplied roll paper adapters.

! Important:
 Insert the paper just before printing. The roller may leave an impression on paper that is left in the printer.

Note:

- ❑ The paper that can be used in the printer is detailed in the following section.
 ↗ “Supported Media” on page 212
- ❑ When the optional MFP Scanner has been attached to the printer using the dedicated stand, raise the scanner until you hear a click.

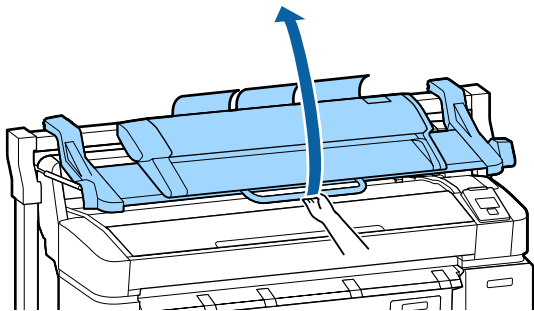

On the SC-T7200D Series/SC-T5200D Series, the methods for loading roll paper on Roll 1 and Roll 2 are different. After attaching the roll paper adapter, see the following sections.

Loading on Roll 1 ↗ “Loading Roll Paper or Roll 1” on page 30

Loading on Roll 2 ↗ “Loading Roll 2(SC-T7200D Series/SC-T5200D Series only)” on page 33

Attaching the Roll Paper Adapter

1 Turn on the printer by pressing the ⏻ button.

Note:

- ❑ Closing the paper basket makes the work easier.
 SC-T7200 Series/SC-T5200 Series/SC-T3200 Series ↗ “Storing and Opening” on page 48
 SC-T7200D Series/SC-T5200D Series ↗ “Storing” on page 51
- ❑ Leaving the poster board supports raised can cause jams; lower all the supports before proceeding. To lower the supports, grasp them, pull them diagonally downward, and then release.

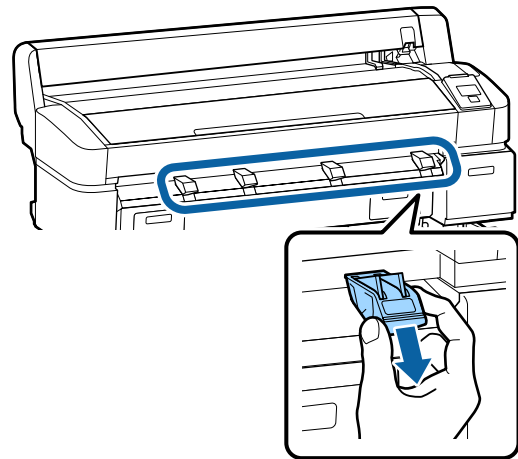

2 Place roll paper on the roll rest on top of the printer.

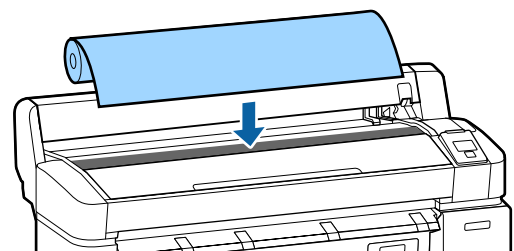

Basic Operations

- 3** Move the size switch levers of the two supplied roll paper adapters in accordance with the roll-core size of the roll paper to be loaded.

3-inch core

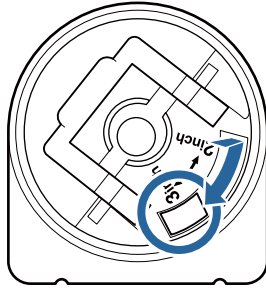

2-inch core

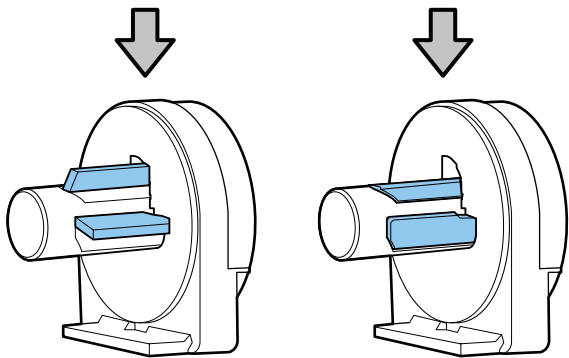
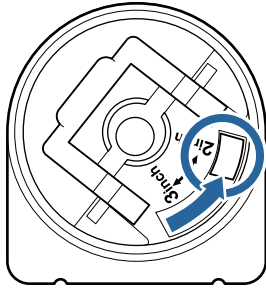

- 4** Raise the adapter lock lever to release the lock on each of the two roll paper adapters.

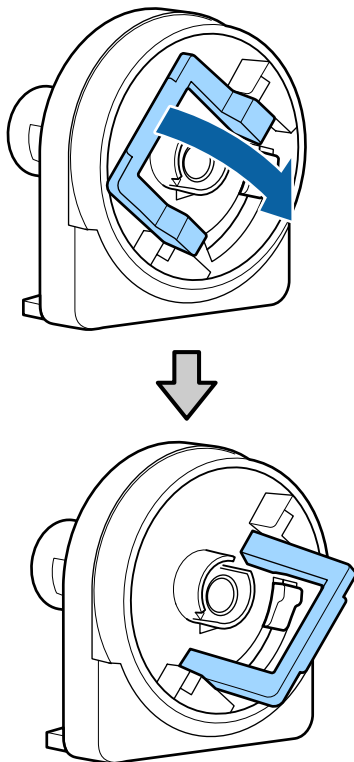

- 5** Attach an adapter to each end of the roll.
Press the adapters in until they are fully inserted in the roll, with no gaps.

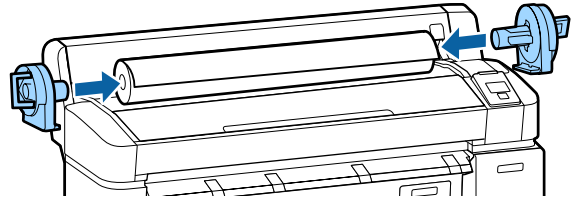

- 6** Lower the lock levers to lock the adapters in place.

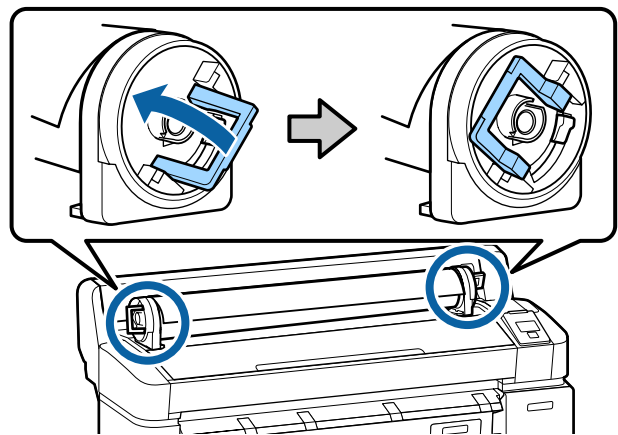

Loading Roll Paper or Roll 1

Buttons that are used in the following settings

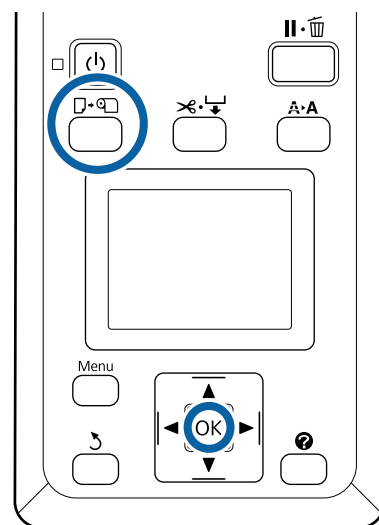

Basic Operations

- 1** Open the roll paper cover.

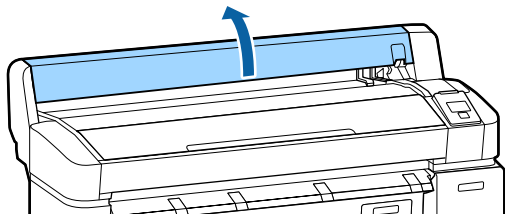

- 2** Confirm that the adapter holder lock lever is raised.

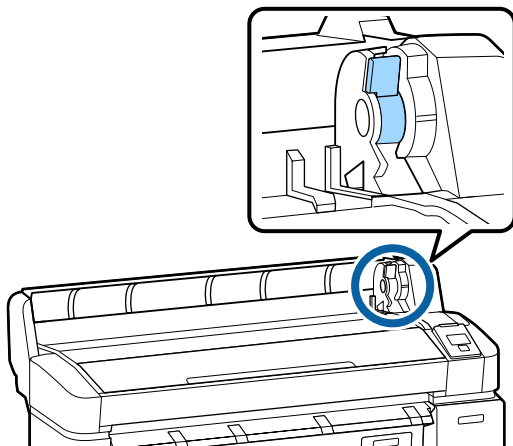

- 3** Slide the roll paper right until it contacts the adapter guide. Next, following the adapter guide, slide the roll slowly inside.

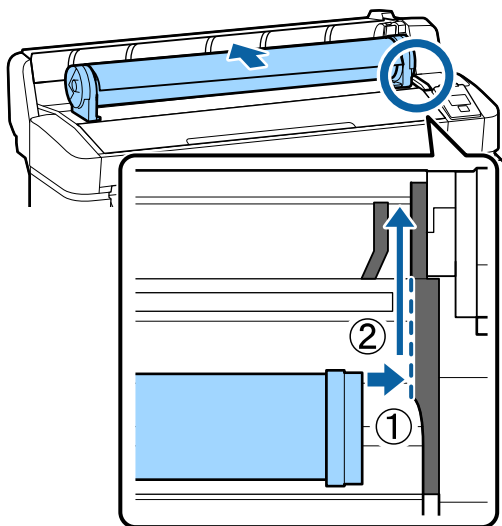

- 4** Press the  button on the control panel. Confirm that **Roll Paper** or **Roll 1** is highlighted in the display and press the OK button.

- 5** Make sure that the roll paper is free of slack and the end is not folded, and then insert it into the paper slot.

When the Auto Loading is set to On on the SC-T7200D Series/SC-T5200D Series

When roll paper is being inserted, a beep tone sounds. If you hear the sound, proceed to Step 6.

SC-T7200 Series/SC-T5200 Series/SC-T3200 Series

When the Auto Loading is set to Off on the SC-T7200D Series/SC-T5200D Series

Pull the edge of the paper straight outside the printer as shown.

If the edge of the paper is not a horizontal or not cut cleanly, you can use the built-in cutter to make a cut in Step 6.

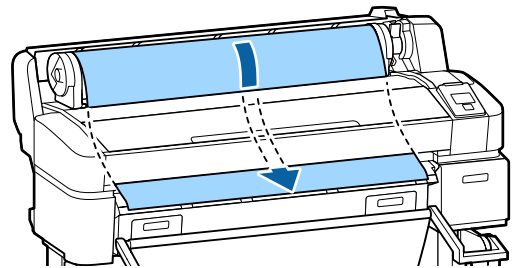

Note:

Do not touch the paper where it will be printed. After loading the roll paper, rotate the roll paper adapters as shown to feed the paper through.

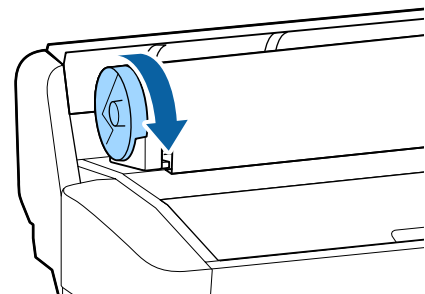

Basic Operations

- 6** Lower the roll paper lock lever, and then press the OK button.

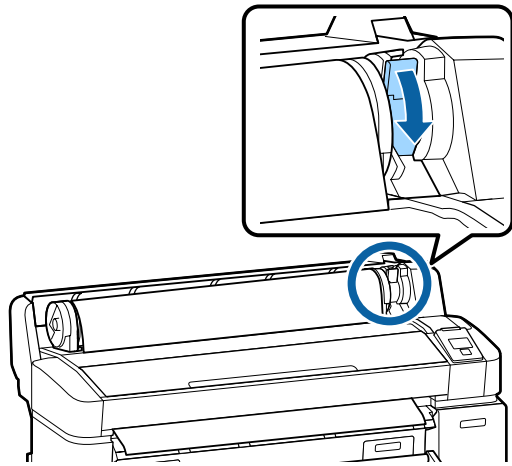

When the **Auto Loading** is set to **Off** on the SC-T7200 Series/SC-T5200 Series/SC-T3200 Series or SC-T7200D Series/SC-T5200D Series, you can cut the edge of the roll paper with the built-in cutter by pressing the OK button, and then pressing the  button within 5 seconds.

- 7** Close the roll paper cover.

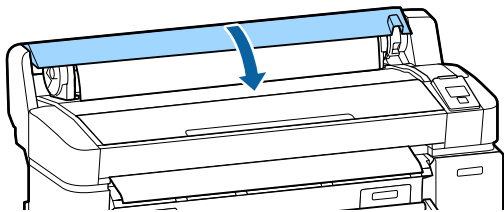

Note:

When the optional MFP Scanner has been raised upon loading roll paper, make sure to return the scanner back in place for use.

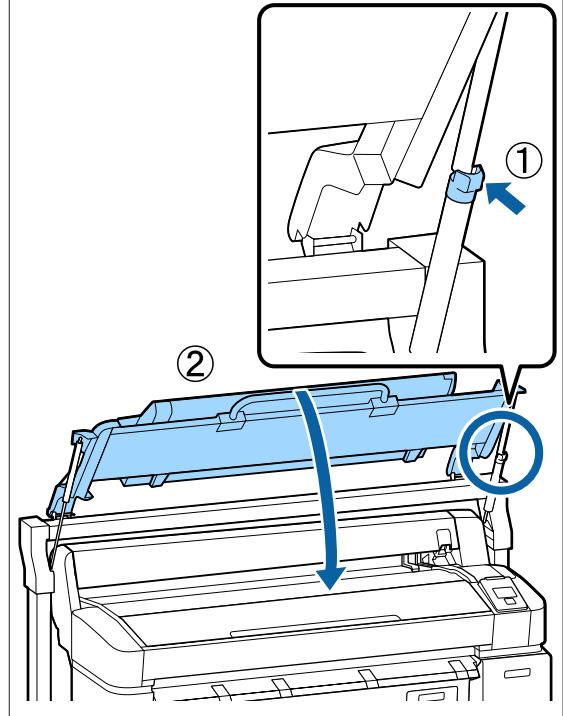

- 8** Check the media type.

If a barcode giving information on the paper is printed on the roll

When the paper is loaded, the barcode is read automatically, and the Media Type and Roll Paper Remaining settings are configured automatically.

After **Ready** is displayed, you can print.

If a barcode giving information on the paper is not printed on the roll

The display shows the Media Type currently selected with the printer.

To print with the displayed settings, use the / buttons to select **Keep Settings Above**, and press the OK button.

To change the settings, select **Change Settings**, and press the OK button.  [“Viewing and Changing Media Settings” on page 45](#)

Basic Operations

**Loading Roll 2
(SC-T7200D Series/SC-T5200D Series only)**

Buttons that are used in the following settings

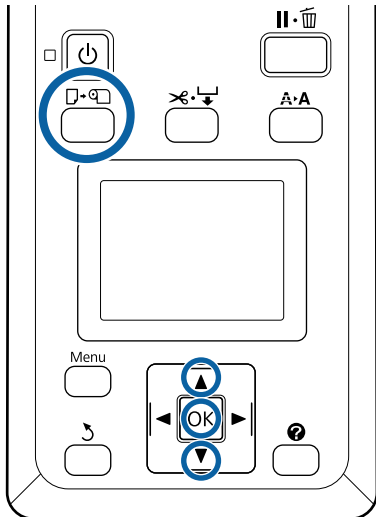

1 Lower the paper basket to the horizontal position.

[“Adjusting the Position” on page 51](#)

2 Press the button on the control panel.

Use the / buttons to select **Roll 2** and press the OK button.

3 Hold the drawer handles of Roll 2 unit, and then pull the unit out.

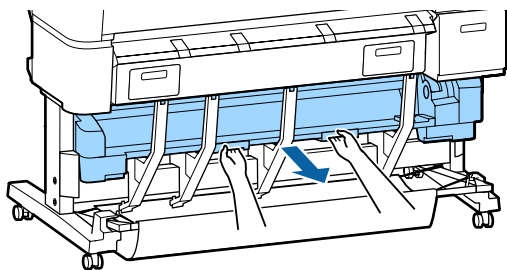

Important:

Do not pull out the Roll 2 unit unless you are instructed to do so by the control panel screen. If the unit is carelessly pulled out while paper is loaded, paper jams or paper damage may occur.

4 Confirm that the roll paper lock lever is raised.

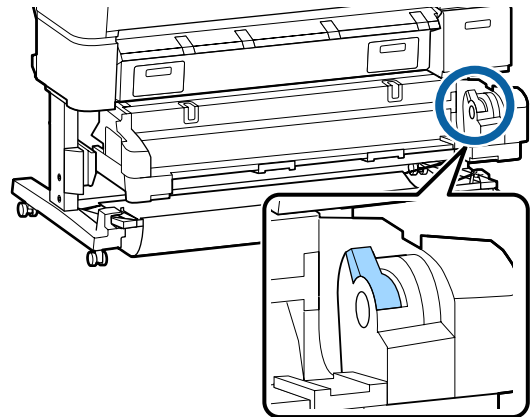

5 Place the roll paper adapters on the adapter guides so the flat surfaces of the adapters is facing down. Next, following the adapter guides, slide the roll slowly inside.

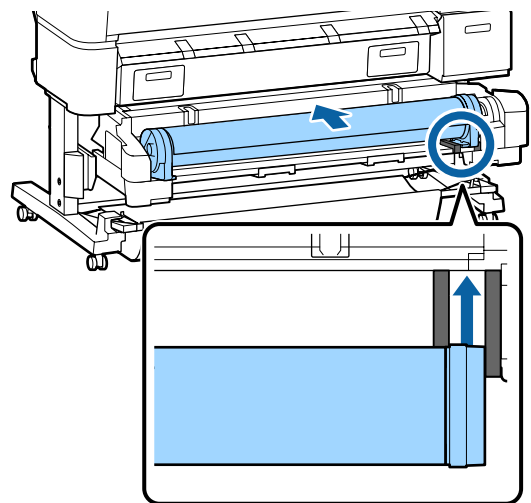

Basic Operations

- 6** Make sure that the roll paper is free of slack and the end is not folded, and then insert it into the paper slot.

If roll paper is being inserted, paper is loaded automatically, and a beep tone sounds.

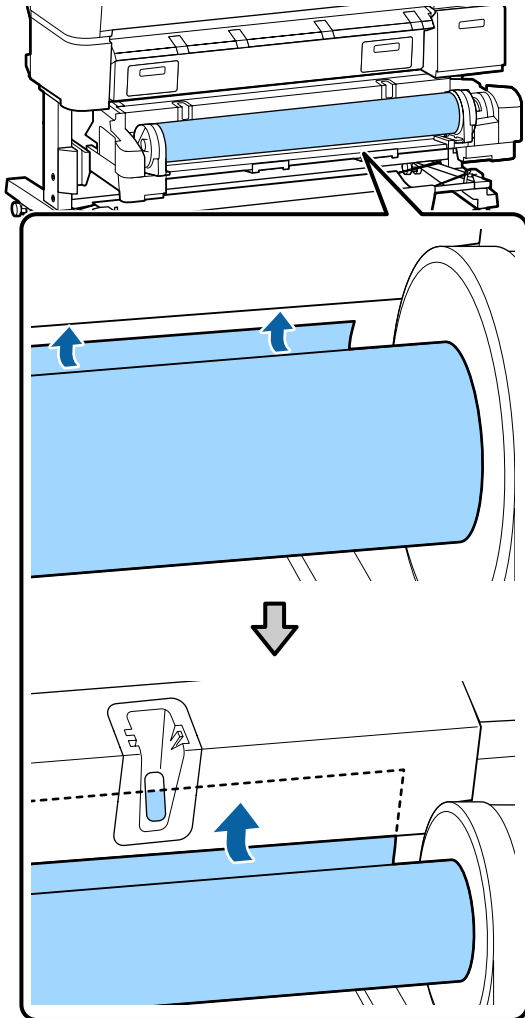

- 7** Lower the roll lock lever.

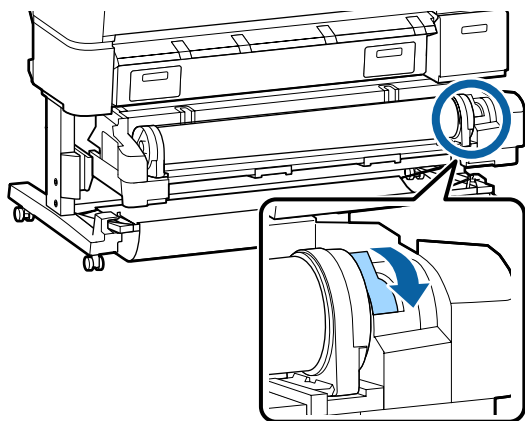

- 8** Set the Roll 2 unit, and then press OK button.

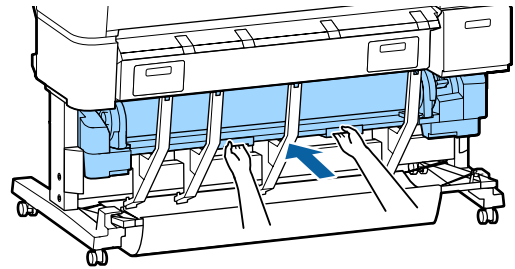

- 9** Check the media type.

If a barcode giving information on the paper is printed on the roll

When the paper is loaded, the barcode is read automatically, and the Media Type and Roll Paper Remaining settings are configured automatically.

After **Ready** is displayed, you can print.

If a barcode giving information on the paper is not printed on the roll

The display shows the Media Type currently selected with the printer.

To print with the displayed settings, use the ▼/▲ buttons to select **Keep Settings Above**, and press the OK button.

To change the settings, select **Change Settings**, and press the OK button. [Viewing and Changing Media Settings](#) on page 45

Cutting the roll paper

The printer is equipped with a built-in cutter. You can cut roll paper after printing by using one of the following methods.

- Auto Cut:

The cutter cuts automatically at a determined position each time a page is printed in accordance with the setting of the printer driver or control panel menu.

- Manual cut:

The cutting position is specified on the control panel, and then the roll paper is cut. A cutline is printed for manual cutting and can be used as a guide when cutting paper using the built-in cutter.



Basic Operations

Important:

The commercially available media types, such as those shown below, may not be cut cleanly by the built-in cutter. Furthermore, cutting the following media types may damage or reduce the lifetime of the built-in cutter.

- Fine art paper
- Canvas
- Vinyl
- Matte poster board
- Adhesive paper
- Banner media

Cut these media types with commercially available scissors or a cutter in the following manner:

Press the  button. Keep the  button pressed to feed the paper so that the cut location is below the paper eject guide. Cut the paper using scissors or a third-party cutter.

When you are using the SC-T7200D Series/SC-T5200D Series, we recommend loading these paper types in Roll 1.

Setting Auto Cut

You can specify the method either on the control panel or the printer driver. Note, however, that the setting selected with the printer driver takes priority when the printer driver is used.

Note:



- Disable printer driver **Auto Cut** and printer **Auto Cut** options when using the optional auto take-up reel unit.
- It may take a while to cut the roll paper.
- If the cutting noise is bothersome, set **Cutting Mode** to **Silent**.

 [“Setup menu” on page 154](#)

Setting on the computer

Set **Auto Cut** from the **Advanced** tab - **Roll Paper Option** in the printer driver's **Properties** (or **Printing preferences**) screen.

Setting from the printer

Use the   buttons of the control panel to select the  tab and press the OK button or Menu button. In the displayed Setup menu, select **Printer Setup** > **Roll Paper Setup** > **Auto Cut** > **On**. For manual cutting, select **Off**. The default setting is **On**.

 [“Setup menu” on page 154](#)



Manual cut method

When **Off** is selected in the printer driver or **Off** is selected for **Auto Cut** in the control panel, the paper can be cut in any location after printing as described below.

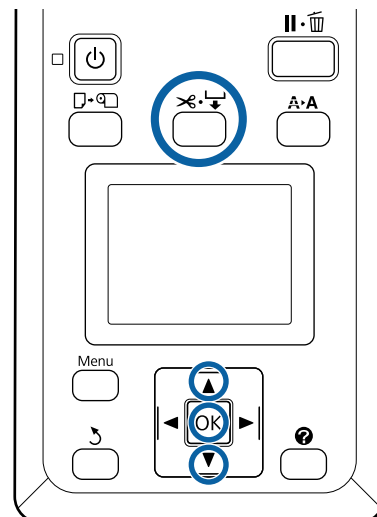
Buttons that are used in the following settings



Basic Operations

- 1 Press the  button. Viewing the interior of the printer without opening the printer cover, press the  button to align the cut location with the  mark on the right side of the printer's interior.

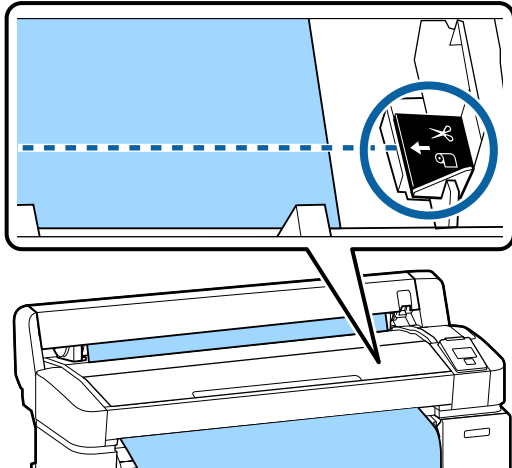

Note:

The minimum length (A) is fixed at a value of from 50 to 127 mm according to the type of media used and cannot be changed. For shorter lengths, auto-feed the paper to the cut location.



- 2 Press the OK button.
The paper is cut by the built-in cutter.

Removing Roll paper or Roll 1

This section describes how to remove and store roll paper after printing. The pressure rollers may leave impressions on paper that is left in the printer.

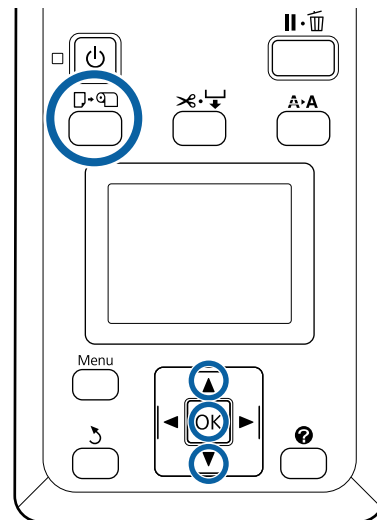
Buttons that are used in the following settings



- 1 Confirm that the printer is ready and press the  button.
The Load/Remove Paper menu will be displayed.
- 2 Press the / buttons to highlight **Remove Paper** and press the OK button.
If you are using the SC-T7200D Series/SC-T5200D Series and roll paper is also loaded on Roll 2, select **Roll 1**, and then press the OK button.
If **On** is selected for **Roll Paper Remaining**, the printer will automatically print a barcode.
- 3 The paper will automatically be rewound.

SC-T7200 Series/SC-T5200 Series/SC-T3200 Series

Once the paper is rewound, the printer will display **Press**  and load paper.

SC-T7200D Series/SC-T5200D Series

After the paper is rewound, a beep tone sounds.

Note:

When the display shows **Turn roll paper adapter to wind up roll paper**, open the roll paper cover and rewind the paper by hand.

Basic Operations

- 4** Open the roll paper cover.

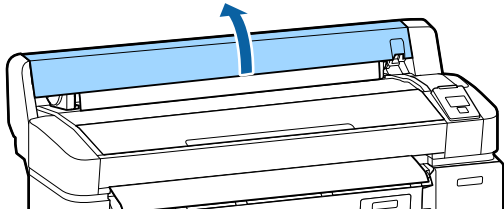

Note:

When removing the roll paper, you can use the optional roll paper belt to prevent the roll paper from unwinding.

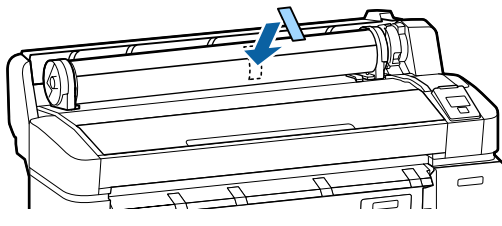

- 5** Raise the roll lock lever.

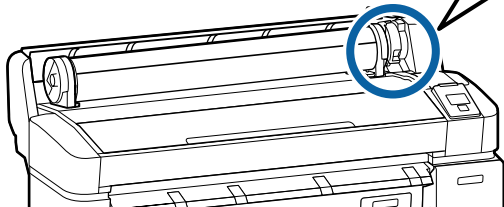
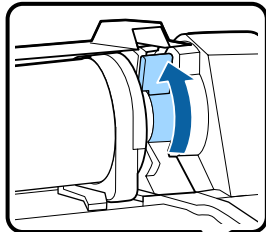

- 6** Holding the paper by the roll adapters, move the roll to the roll rest.

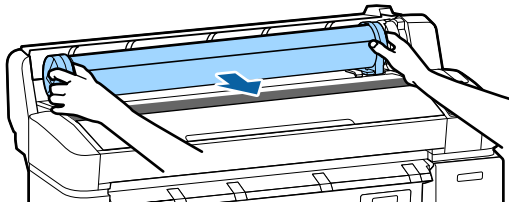

- 7** Lift the adapter lock levers to release the roll paper adapters.

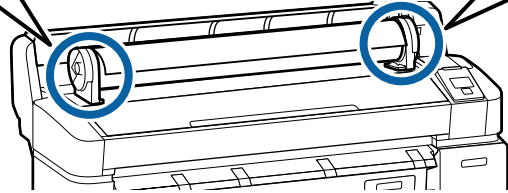
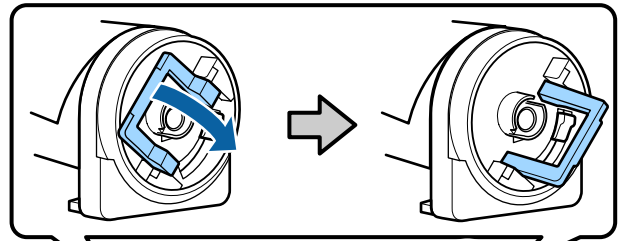

- 8** Remove the roll paper adapters.

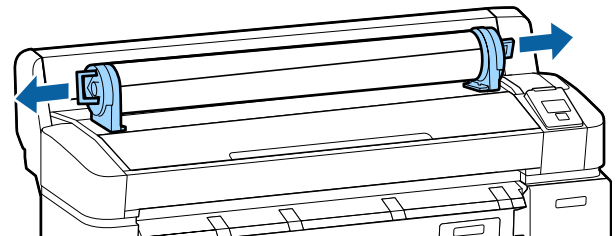

After rewinding the roll paper carefully, store it in the original package.

Close the roll paper cover.





Removing Roll 2 (SC-T7200D Series/SC-T5200D Series only)

This section describes how to remove and store roll paper of Roll 2 after printing. The pressure rollers may leave impressions on paper that is left in the printer.

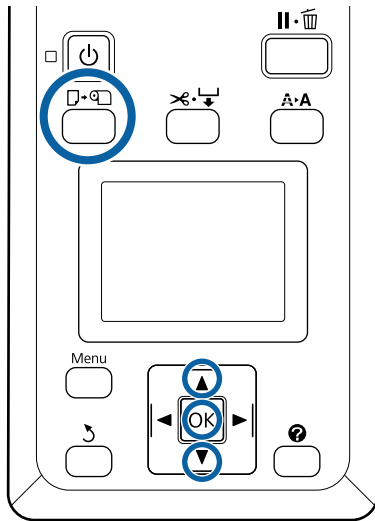
Basic Operations

Buttons that are used in the following settings



- 1 Confirm that the printer is ready and press the  button.
The Load/Remove Paper menu will be displayed.
- 2 Press the / buttons to highlight **Remove Paper** and press the **OK** button.
If roll paper is also loaded on Roll 1, select **Roll 2**, and then press the **OK** button.
If **On** is selected for Roll Paper Remaining, the printer will automatically print a barcode.
- 3 The paper will automatically be rewound.
After the paper is rewound, a beep tone sounds.
- 4 Lower the paper basket to the horizontal position.
 [“Adjusting the Position” on page 51](#)
- 5 Hold the drawer handles of Roll 2 unit, and then pull the unit out.

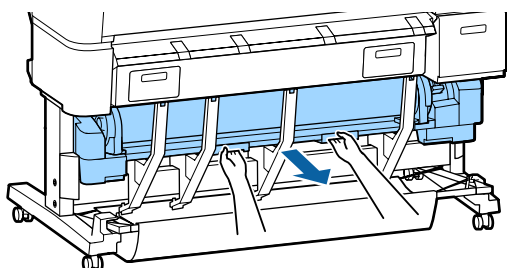

Note:
When removing the roll paper, you can use the optional roll paper belt to prevent the roll paper from unwinding.

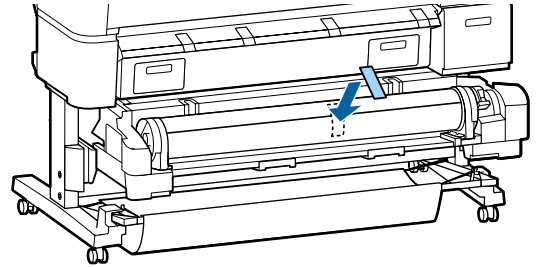

- 6 Raise the roll lock lever.

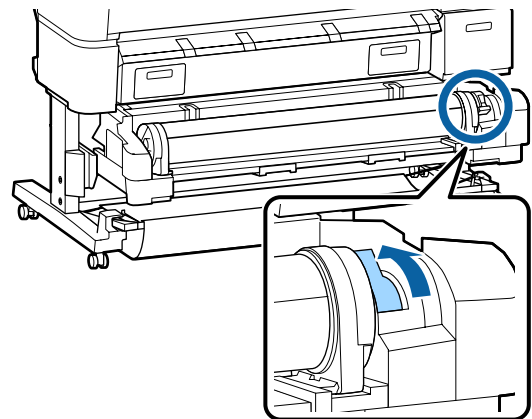

- 7 Move the roll paper to the roll rest.

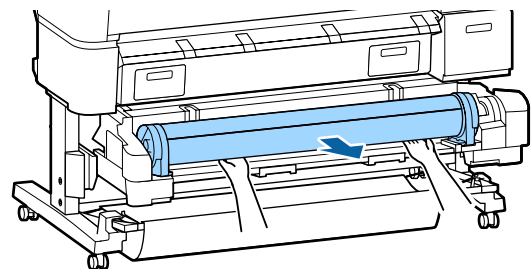

- 8 Set the Roll 2 unit.

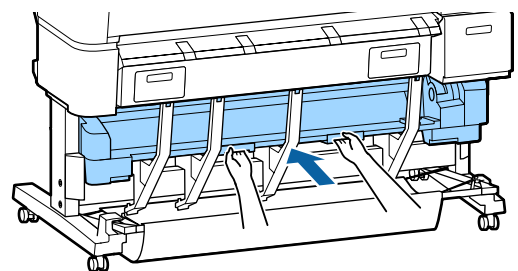

Basic Operations

- 9** Lift the adapter lock levers to release the roll paper adapters.

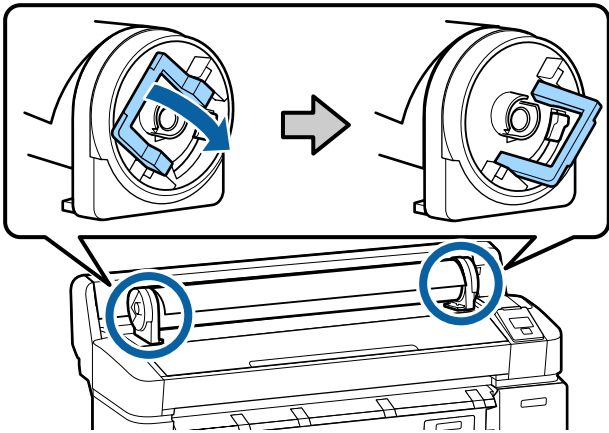

- 10** Remove the roll paper adapters.

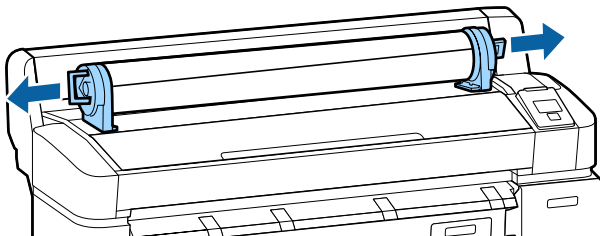

After rewinding the roll paper carefully, store it in the original package.

Loading and Removing Cut Sheets

The procedure for loading and positioning cut sheets varies with the thickness of the paper.

0.08 to 0.8 mm [☞ “Loading Cut Sheets” on page 39](#)

0.8 to 1.5 mm [☞ “Loading Poster Board” on page 41](#)

! Important:

If the paper is wavy or curled, flatten the paper before loading it in the printer, or use new paper. If wavy or curled paper is loaded, this printer may not be able to recognize the paper size, feed the paper, or print correctly.

We recommend that you return the paper to its original package and store it flat, and take it out of the package just before you use it.

Loading Cut Sheets

! Important:

Insert the paper just before printing. The pressure rollers may leave impressions on paper that is left in the printer.

Note:

The paper that can be used in the printer is detailed in the following section.

[☞ “Supported Media” on page 212](#)

Basic Operations

Buttons that are used in the following settings

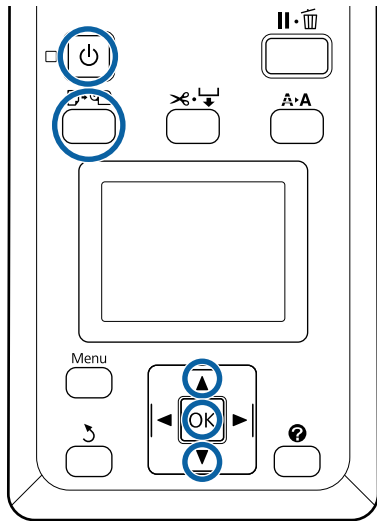

- 1 Turn on the printer by pressing the button.

Note:

- ❑ Closing the paper basket makes the work easier.

SC-T7200 Series/SC-T5200 Series/SC-T3200 Series [☞](#) “Storing and Opening” on page 48

SC-T7200D Series/SC-T5200D Series [☞](#) “Storing” on page 51

- ❑ Leaving the poster board supports raised can cause jams; lower all the supports before proceeding. To lower the supports, grasp them, pull them diagonally downward, and then release.

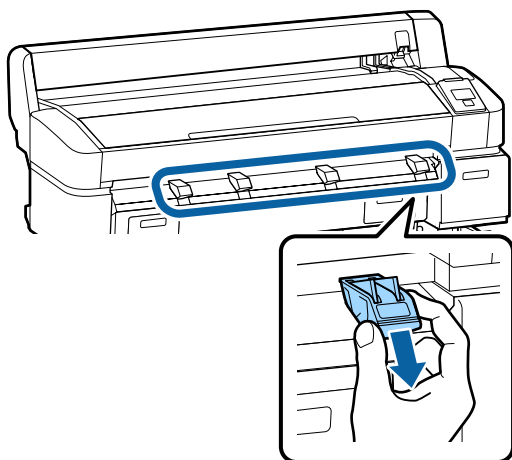

- 2 Press the button on the control panel. Press the / buttons to select **Cut Sheet** and press the OK button.

- 3 Feed the paper into the paper slot with the printable surface toward you.

Insert the paper into the paper slot, keeping its right edge aligned with the loading mark on the roll paper cover. Slide the paper in until it stops.

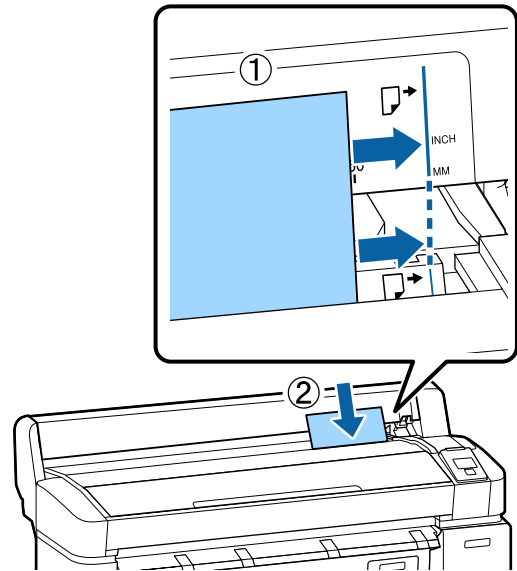

! Important:
Insert all paper in portrait orientation. Inserting paper in landscape orientation may cause a decline in print quality.

- 4 Confirm that **Press OK** is displayed and press the OK button.

The paper will be fed into the printer.

- 5 Check the media type.

The display shows the type of paper currently selected with the printer. To print with the displayed settings, use the / buttons to select **Keep Settings Above**, and press the OK button. To change the settings, select **Change Settings**, and press the OK button. [☞](#) “Viewing and Changing Media Settings” on page 45

Removing Cut Sheets

This section describes how to remove cut sheets when printing is complete.

Basic Operations

Note:

To remove paper that was loaded but not used, press the  button and select **Remove Paper**.

Buttons that are used in the following settings

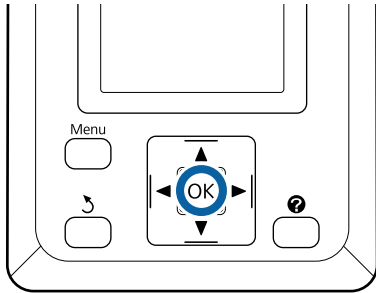

- 1 Confirm that **Paper Eject** is displayed in the control panel.
 Keeping a hand on the cut sheets to prevent them falling from the printer, press the OK button.
- 2 The paper will be fully ejected from the printer and can then be removed by hand.

Loading and Removing Poster Board

This section describes how to load and remove poster board from 0.8 to 1.5mm thick.

The printer can be used with board of the following sizes.

A2/A1/B2/B1*/B1 landscape*/24 × 30 inch/30 × 40 inch*

* Not supported by the SC-T3200 Series.

Loading Poster Board

Poster board requires space both behind and in front of the printer. The approximate amount of space required is shown below. If the printer is set up near a wall, make sure there is enough space at the rear.

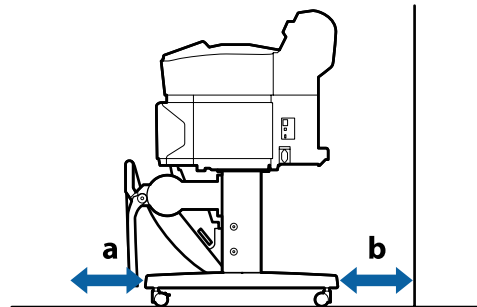

Paper Size	Front (a)	Back (b)
A2	444mm	135mm
A1	691mm	382mm
24 × 30 inch	612mm	303mm
30 × 40 inch	866mm	557mm



Important:

Insert the paper just before printing. The roller may leave an impression on paper that is left in the printer.

Basic Operations

Note:

The paper that can be used in the printer is detailed in the following section.

☞ [“Supported Media” on page 212](#)

Buttons that are used in the following settings

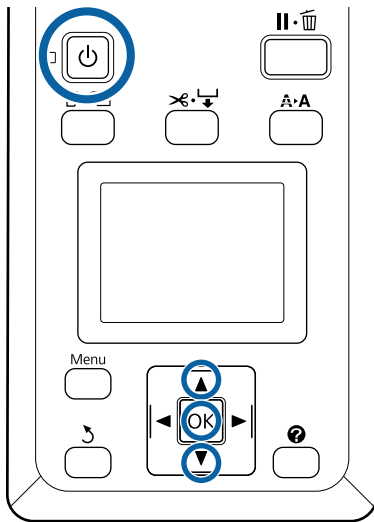



- 1 Turn on the printer by pressing the  button.

Note:

Closing the paper basket makes the work easier.

SC-T7200 Series/SC-T5200 Series/SC-T3200 Series ☞ [“Storing and Opening” on page 48](#)

SC-T7200D Series/SC-T5200D Series ☞ [“Storing” on page 51](#)

- 2 Press the  button on the control panel. Press the /  button to select **Poster Board** and press the OK button.

- 3 Raise all the poster board supports.

Press the supports diagonally downwards and then lift them straight up.

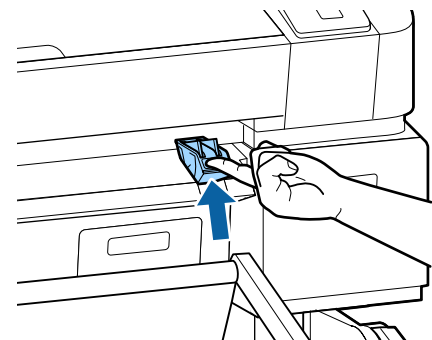
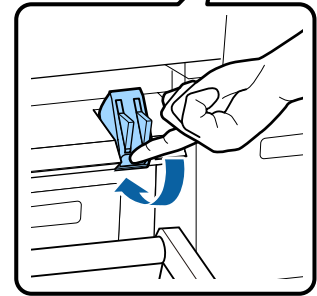
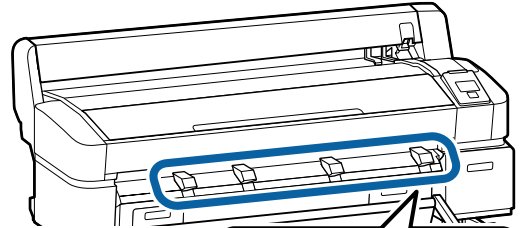

- 4 Place the side to printable face up with its edge in front of the projecting supports as shown.

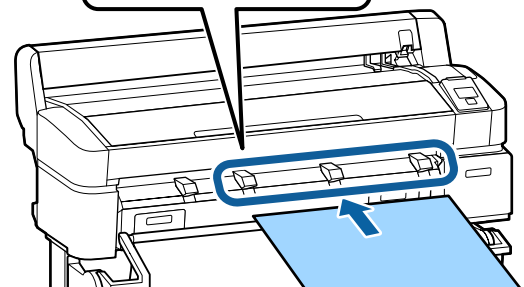
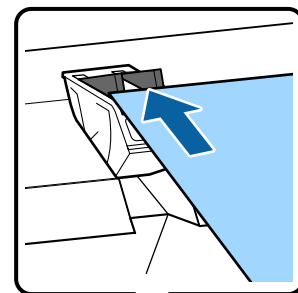

Basic Operations

- 5** Insert the board, using the edge to keep the supports pressed down.

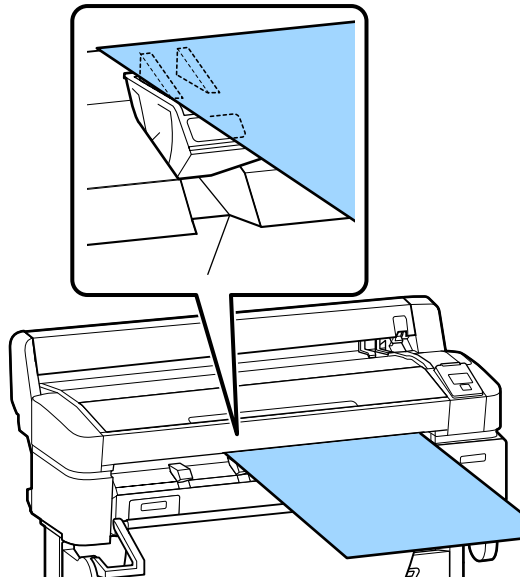

- 6** Open the printer cover.

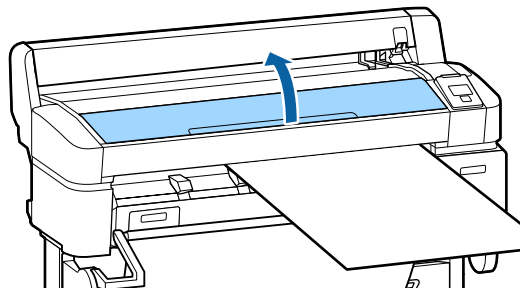

- 7** Insert the board, checking to be sure that it passes under the rollers.

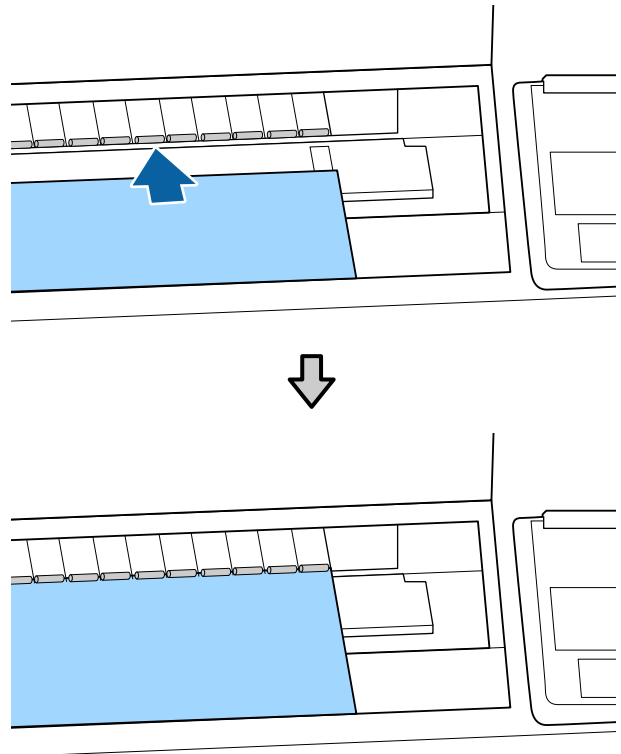

- 8** Close the printer cover.

- 9** Position the trailing and right edges of the board as shown by the loading indicators.

Center the right edge over the groove to the right of the paper eject guide and align the trailing edge with the ends of poster board supports, as shown.

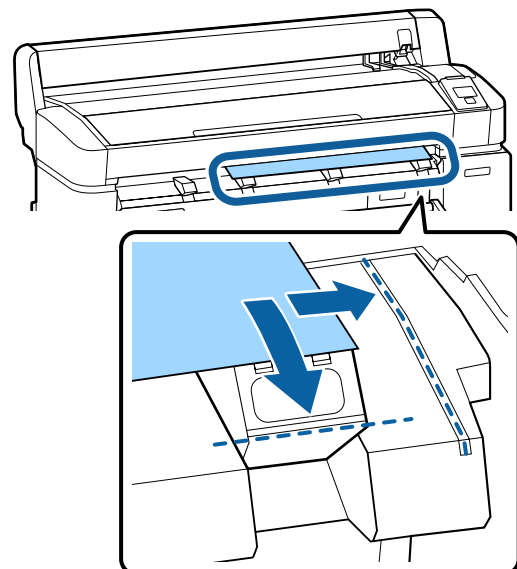

Basic Operations

- 10** After positioning the media, press the OK button.

The paper will be fed into the printer.

- 11** Check the media type.

The display shows the type of paper currently selected with the printer. To print with the displayed settings, use the ▼/▲ buttons to select **Keep Settings Above**, and press the OK button. To change the settings, select **Change Settings**, and press the OK button. [↗](#) “Viewing and Changing Media Settings” on page 45

Removing Poster Board

This section describes how to remove poster board when printing is complete.

Note:

To remove paper that was loaded but not used, press the  button and select **Remove Paper**.

Buttons that are used in the following settings

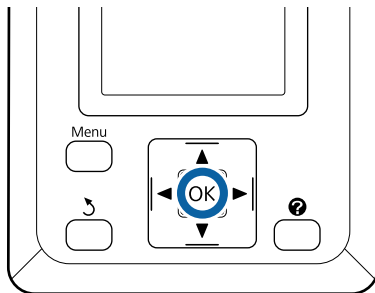

- 1** Confirm that **Paper Eject** is displayed in the control panel.

Keeping a hand on the poster board to prevent it falling from the printer, press the OK button.

- 2** Pull the poster board forward as shown in the on-screen instructions.

After removing the poster board, press the OK button.

! Important:

If poster board will not be used in the next print job, lower all the poster board supports. Leaving the supports raised may cause paper to jam.

To lower the supports, grasp them as shown, pull them diagonally downward, and then release.

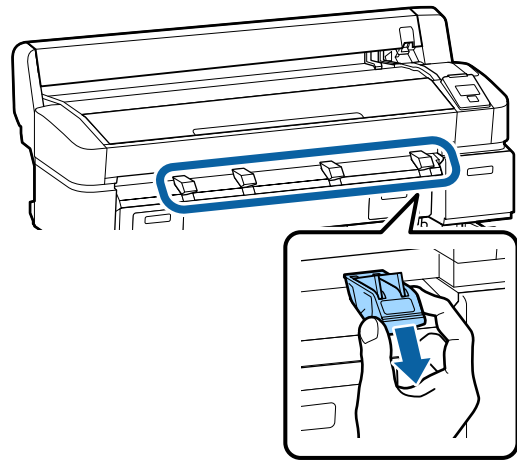

Basic Operations

Viewing and Changing Media Settings

After the paper is loaded, the control panel screen shows the media type currently selected with the printer.

Note:
 If **On** is selected for **Roll Paper Remaining** and roll paper with a barcode for roll data is loaded, the printer will read the barcode and adjust settings automatically.

Follow the steps below to change the settings displayed. When you are using SC-T7200D Series/SC-T5200D Series, the settings are saved for each roll of paper that is set (roll 1/roll 2).

Buttons that are used in the following settings

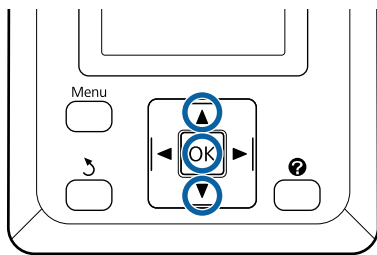

- 1** Use the ▼/▲ buttons to select **Change Settings** and press the OK button.

If you will print with the displayed media type, select **Keep Settings Above**, and press the OK button. Next, proceed to Step 5.

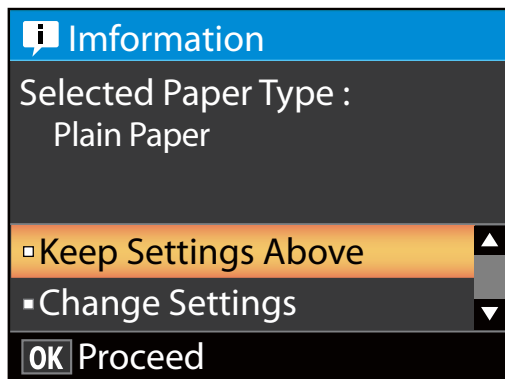

- 2** Select the media type, and then press the OK button.

- 3** Select the media name, and then press the OK button.

- 4** If **On** is selected for **Roll Paper Remaining**, you will be prompted to enter the length of the roll. Press the ▼/▲ buttons to choose a value between 5.0 and 150 m and press the OK button. You can set in 0.5 m increments.

If you press the ► button, you can change **Roll Paper Remaining** to **Off**.

To change the setting back to **On**, use **Roll Paper Remaining** in the Paper menu.

[🔗 “Paper menu” on page 149](#)

The printer will display **Ready** after a brief pause, showing that it is ready to print. Send the data to be printed from the computer.

Roll Paper Remaining

When **On** is selected for **Roll Paper Remaining**, the printer tracks the following roll paper data.

- Time until replacement

The following settings are recorded in a barcode printed on the roll.

The amount of paper remaining, the value selected for remaining alert, and the paper type.

The barcode is automatically printed at the end of the roll when the roll is rewound. The barcode is automatically read and settings adjusted the next time the paper is used, improving efficiency when multiple rolls of paper are used.

- Tracking the amount of paper remaining in the  tab info display area

The info display area shows the amount of paper remaining in the current roll. Once the amount of paper remaining falls below the limit, the amount is replaced by a warning indicator showing that paper is running low.

[🔗 “Screen View” on page 15](#)

Basic Operations

❑ Printing Availability

The printer predicts whether the current job can be printed on the amount of paper remaining and displays the results, preventing waste caused the paper running out part way through a print job. This allows you to choose whether to print on the existing roll or replace the paper, preventing waste.

The SC-T7200 Series/SC-T5200 Series/SC-T3200 Series can predict availability only when the optional hard disk unit or Adobe PostScript 3 Expansion Unit has been installed.

 [“Saving to and Reprinting on the Optional Hard Disk Unit” on page 69](#)

If paper has run out, the SC-T7200D Series/SC-T5200D Series can switch to Roll 1 or Roll 2 automatically based on predicted availability and continue printing.

 [“Switching to the Roll with the Most Paper Remaining \(Roll 1/Roll 2\) before Printing if the Paper Runs Out” on page 100](#)

Replacing Paper

This section describes how to replace paper. The process for removing the current paper differs with the type of paper loaded; follow the instructions displayed in the control panel.

Buttons that are used in the following settings

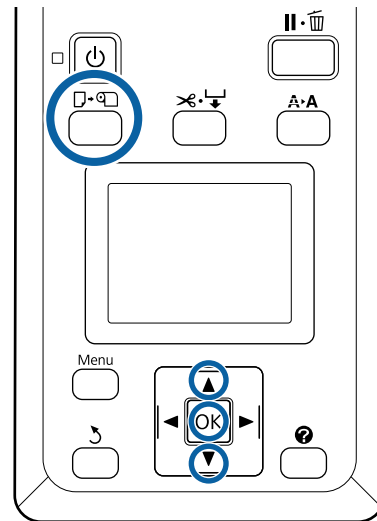

- 1 Confirm that the printer is ready and press the  button.

The Load/Remove Paper menu will be displayed.

- 2 Press the ▼/▲ buttons to select the type of paper used to replace the current paper, and then press the OK button.

- 3 The printer will eject the current paper.

The process for ejecting the paper varies with the type of paper loaded, as described below.

If On is selected for Roll Paper Remaining
Barcode printing will begin; when printing is complete, the roll will rewind automatically.

If Off is selected for Roll Paper Remaining
The roll rewinds automatically.

Note:

When the display shows **Turn roll paper adapter to wind up roll paper**, open the roll paper cover and rewind the paper by hand.

Basic Operations

Cut Sheets

Cut sheets are automatically ejected to the rear, where they can be removed by hand.

Poster Board

Poster board is partially ejected to the front. Supporting the board with one hand to prevent it falling, press the OK button and pull out the board.

If the next job will not use poster board, lower all the poster board supports. Leaving the supports raised may cause paper to jam.

To lower the supports, grasp them as shown, pull them diagonally downward, and then release.

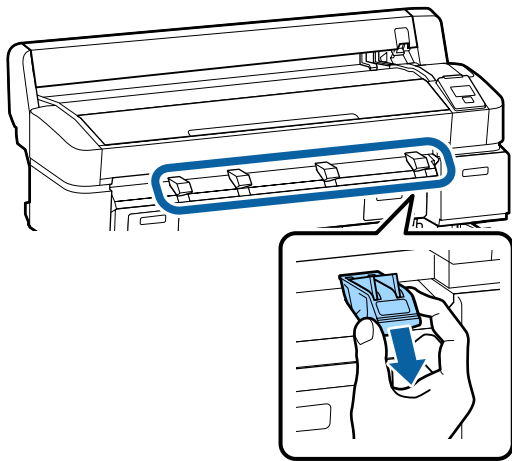

- 4** Follow the on-screen instructions to load the paper for the next job.

Using the Paper Basket (SC-T7200 Series/ SC-T5200 Series/ SC-T3200 Series)

The paper basket collects paper from the printer, preventing it falling to the floor and becoming creased or dirty.

The optional Stand (24) for the SC-T3200 Series comes with a paper basket.

If one sheet is to be collected, paper up to the following sizes can be collected regardless of the paper type.

Maximum size when one sheet is collected

	Paper Width	Paper Length
SC-T7200 Series	About 1,118 mm / 44 inches	Approx. 1,189 mm
SC-T5200 Series	About 914 mm / 36 inches	
SC-T3200 Series	About 610 mm / 24 inches	

When collecting one sheet, use the paper basket in the standard position.

Adjusting the Position [“Adjusting the Position” on page 49](#)

Note:

Close the paper basket before printing banners or other documents that exceed the maximum length. Before the paper ejected from the printer touches the floor, we suggest that you take it in both hands close to the paper eject guides and continue to lightly support it until printing is complete.

The basket can hold up to 20 sheets of the same size when you print in line drawing mode to plain paper rolls of the following sizes.

When the paper basket will collect paper continually, change the position of the paper basket in accordance with the paper size to be stored.

Basic Operations

Adjusting the Position  “Adjusting the Position” on page 49

 “Adjusting the Position” on page 49

Paper size and position during continual collection

Paper Size	Position
A1 Portrait (594 × 841 mm)	Standard position (lower stack guide)
US D Portrait (22×34 in)	
A0 Portrait (841 × 1189 mm)*	Standard position (raise stack guide)
US E Portrait (34×44 in)*	
A2 Portrait (420 × 594 mm)	Horizontal position
ARCH C Portrait (18×24 in)	
A1 Landscape (841 × 594 mm)*	
ARCH D Portrait (36×24 in)*	
US D Portrait (34×22 in)*	

* Not supported by the SC-T3200 Series.



Important:

If you print to plain paper sizes other than the sizes above, collecting consecutive sheets in the paper basket may result in stains, folds, or other damage to the printed sheets. When you print continuously, remove the sheet in the printer before the next sheet is collected.

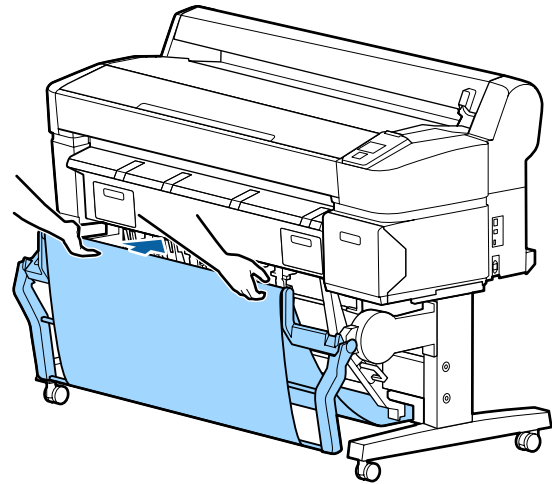

Opening

If the paper basket is closed, it can be opened for use as described below.

Lightly pull the paper basket down.

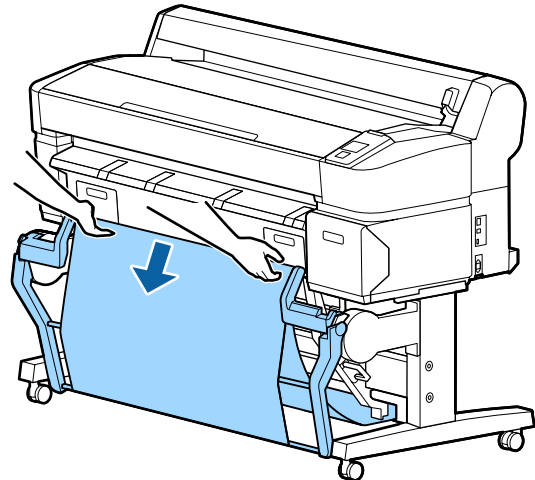

Storing and Opening

Storing

Close the paper basket before loading paper or moving the printer.

Press the paper basket to the opposite side.

A paper basket in the horizontal position cannot be stored. Set the basket to the standard position before storing it.

Basic Operations

! Important:

The paper basket will not function correctly when opened to the position shown below at right.

Stop when the paper basket is in the position shown below at left.

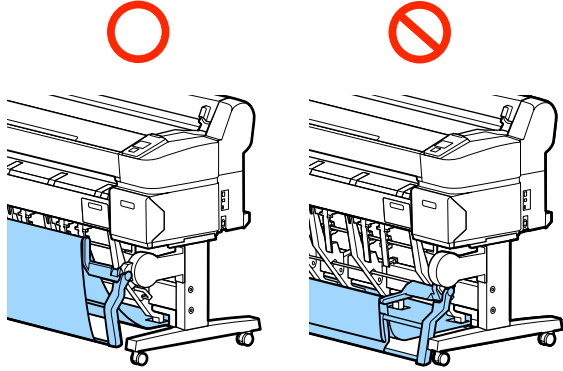

Adjusting the Position

Adjust the position to match the size of the paper to be collected.

Note:

The paper basket may with some documents or in some environments fail to hold the paper correctly, resulting in the paper wrinkling or folding.

Standard position

- 1 Pull the basket toward you slightly, and lower it.

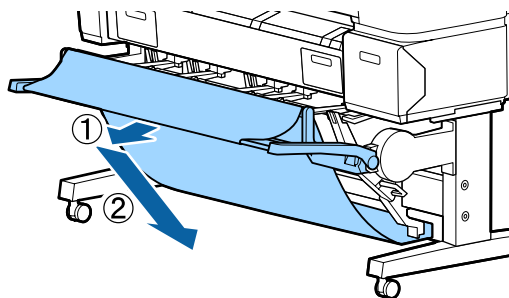

- 2 Use the top stack guide switching lever to lower the top stack guide.

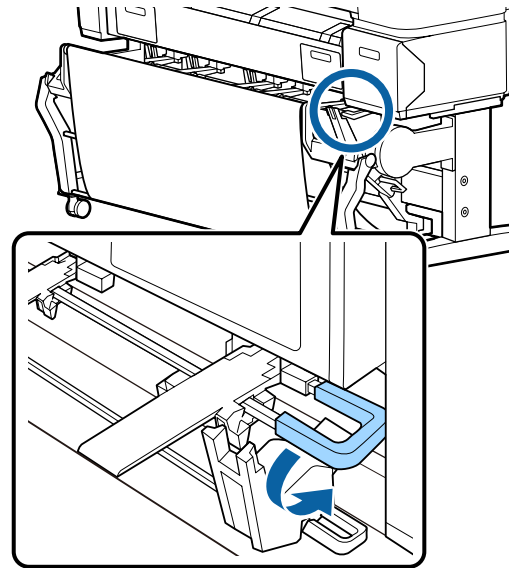

As shown in the following illustrations, adjust the lower stack guide to match the size of the paper to be collected.

Guide positioned for continual collection of A1 Portrait/US D Portrait (22 × 34 in) size paper

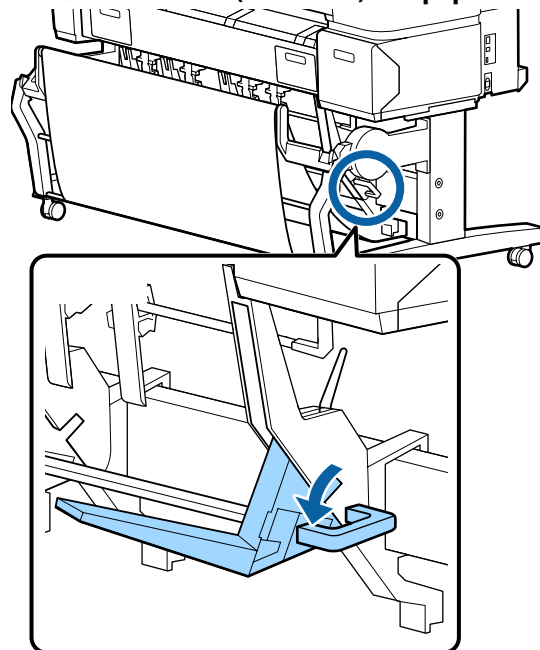

Basic Operations

Guide positioned for other sizes of paper

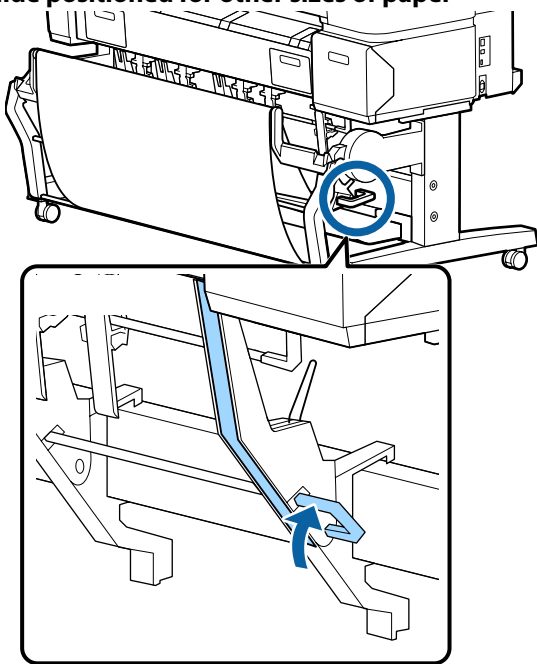

Horizontal position

- 1 Use the top stack guide switch lever to raise the top stack guide.

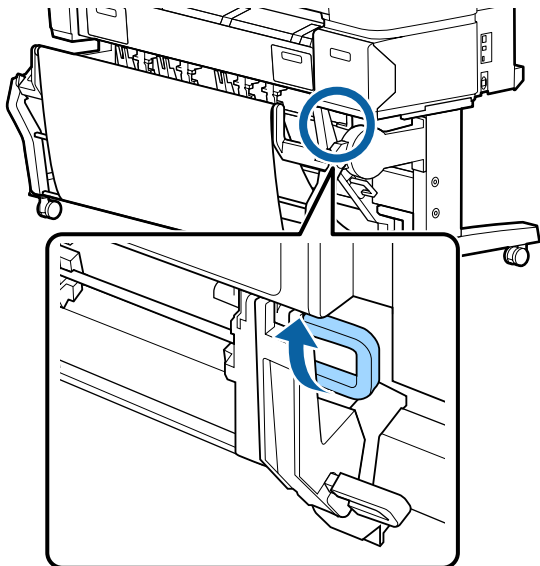

- 2 Lift the guide up, and then lower it lightly.

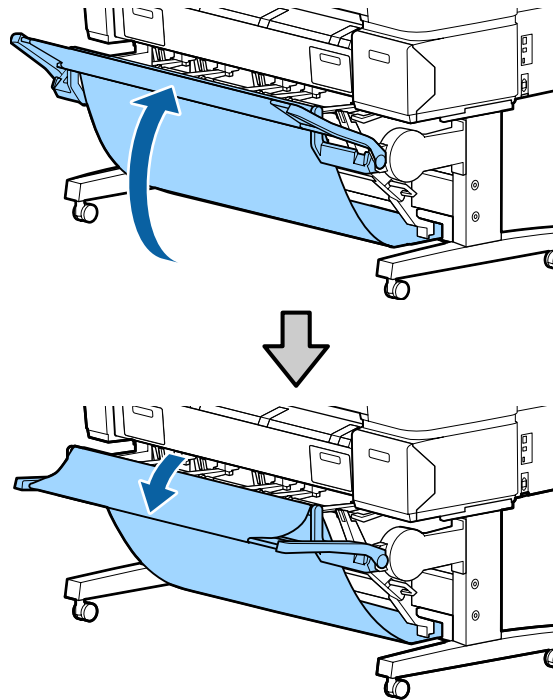

Note:

If the standard position is erroneously set instead of the horizontal position, lift the guide up, and then lower it while pushing lightly.

Basic Operations

Using the Large-Capacity Paper Basket (SC-T7200D Series/SC-T5200D Series)

The large-capacity paper basket collects paper from the printer, preventing it from falling to the floor and becoming creased or dirty.

If a single sheet is to be collected, any size or type of paper can be collected after printing.

The following chart shows the maximum paper lengths that can be collected.

Maximum paper length when a single sheet is collected

Large-capacity position	Approx. 1,580 mm
Compact position	Approx. 1,189 mm

Note:

Close the paper basket before printing banners or other documents that exceed the maximum length. Before the paper ejected from the printer touches the floor, we suggest that you take it in both hands close to the paper eject guides and continue to lightly support it until printing is complete.

When you print in line drawing mode on a plain paper roll, this basket can collect various sizes of sheets* up to A1 Landscape.

When collecting multiple sheets, use the paper basket in the large-capacity position.

Adjusting the Position  [“Adjusting the Position” on page 51](#)

* Up to 20 sheets under normal temperatures. Note that the number of sheets that can be collected is reduced by work environment, images to be printed, and other factors. If too many sheets are collected, a paper jam may occur.

Important:

If you collect consecutive sheets of A1 Portrait plain paper or larger, stains, folds, or other damage to the printed sheets may occur.

Storing and Adjusting the Position

Storing

Close the large-capacity paper basket before loading paper or moving the printer.

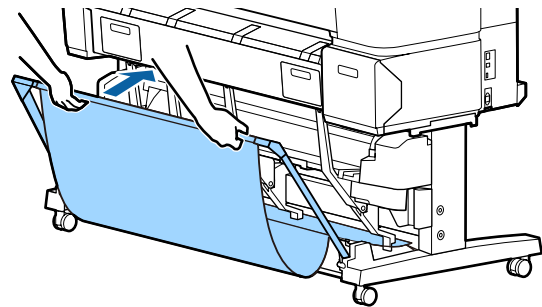

Adjusting the Position

Compact position

Drop down the basket to the position in which it is fixed by the lower protrusions of the left and right frames.

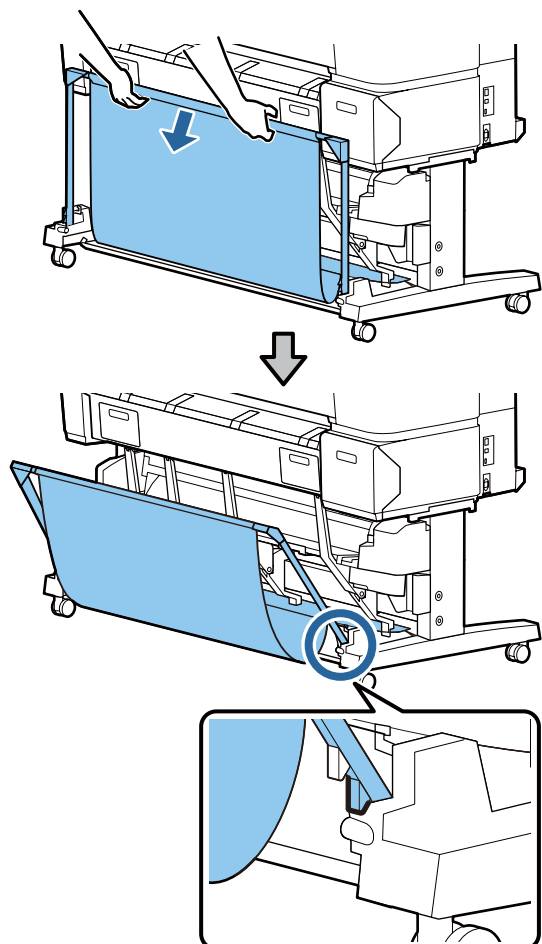

Basic Operations

Large-capacity position

Pull the basket toward you slightly, and then lower it.

Lower the basket to the position in which it is fixed by the upper protrusions of the left and right frames.

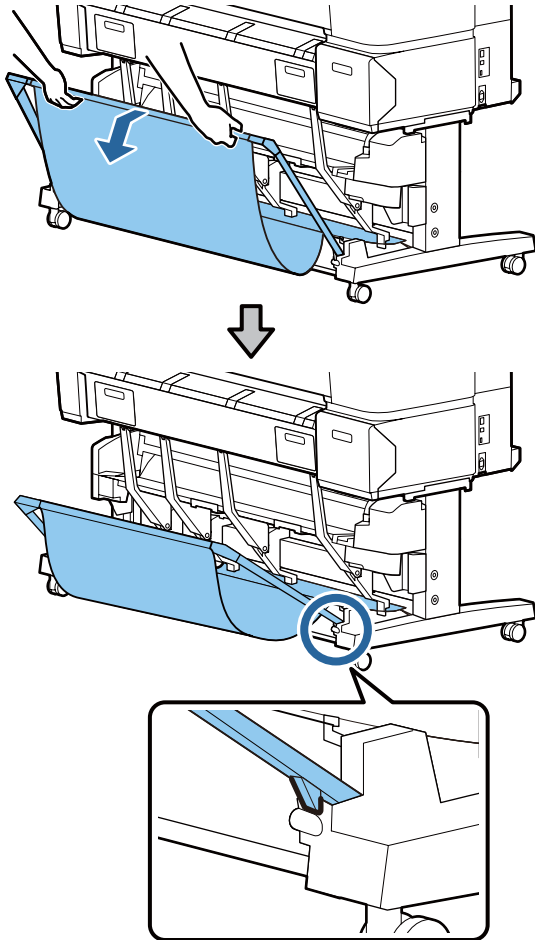

Horizontal position

Pull the basket toward you slightly, and then lower it.

Next, push it in straight.

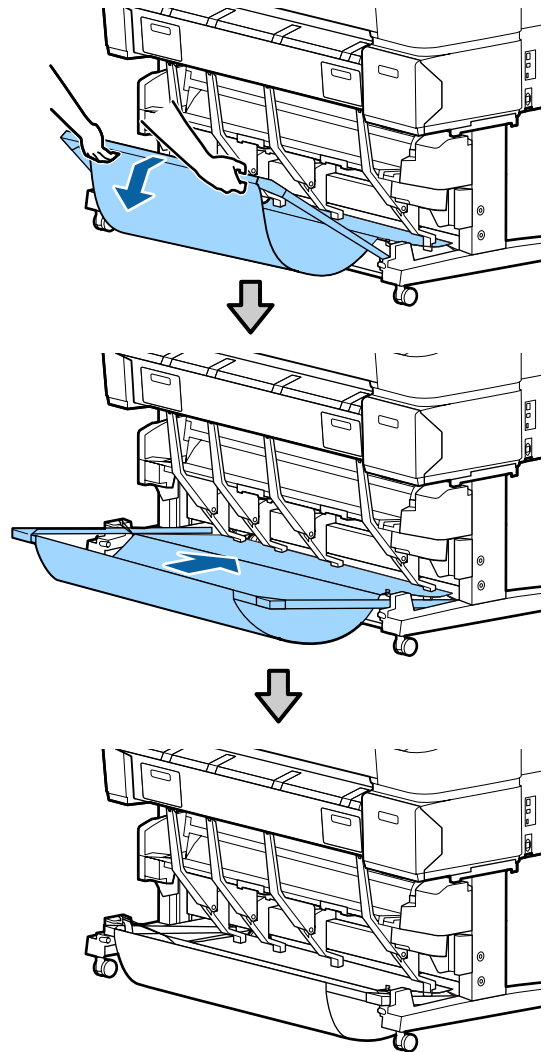

To change the basket from the horizontal position to another position, reverse the procedure above.

Basic Operations

Using the Auto Take-up Reel Unit (SC-T7200 Series Only)

The optional auto take-up reel unit automatically takes up paper as it is printed. It improves efficiency for banners or large jobs involving continuous printing on roll paper.

The auto take-up reel unit for this printer can take up paper in either of the directions shown below. Some types of paper may not support one or the other of these directions or may place restrictions on the take-up direction.

See the following section for information on take-up support and take-up direction.

📖 “Epson Special Media Table” on page 212

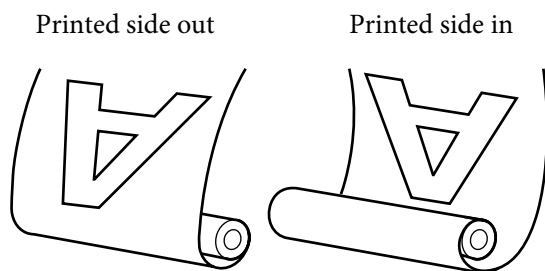

Taking-up with printed side out places the printed surface on the outside of the roll.

Taking-up with printed side in places the printed surface on the inside of the roll.

⚠️ Caution:

- ❑ Fix the roll core for the auto take-up reel unit in place as described in the documentation. Dropping the roll core could cause injury.
- ❑ Be careful that your hands, hair, or other objects do not get caught in the moving parts of the auto take-up reel unit. Failure to observe this precaution could result in injury.



Important:

Confirm that the end of the roll is cut straight across. The unit will not function as expected if the end of the roll is wavy or curved.

📖 “Manual cut method” on page 35

Note:

For information on installing the auto take-up reel unit, see the documentation supplied with the auto take-up reel unit attachment.

Using the Control Panel

This section describes how to use the control panel for the auto take-up reel unit.

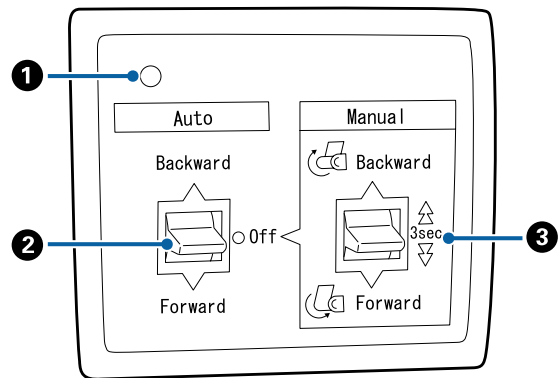

1 Power lamp

Displays the status of the auto take-up reel unit.

- On : The auto take-up reel unit is ready for use.
- Flickering : The auto take-up reel unit is in use.
- Blinking : The auto take-up reel unit is in power-saving mode.
- Intermittent blinking : An error has occurred.
- Off : The power is off.

2 Auto switch

Selects the auto take-up direction.

Basic Operations

Backward : The roll is taken up with the printable side in.

Forward : The roll is taken up with the printable side out.

Off : The auto take-up reel unit does not take up paper.

3 Manual switch

Selects the manual take-up direction.

The setting selected with the Manual switch takes effect when the Auto switch is in the Off position.

Backward : The roll is taken up with the printable side in.

The speed will increase after the button is pressed for more than three seconds.

Forward : The roll is taken up with the printable side out.

The speed will increase after the button is pressed for more than three seconds.

Attaching the Paper

This section describes how to attach roll paper to the auto take-up reel unit roll core.

The procedure varies with the take-up direction.



Important:

Before proceeding, select **Off** for **Auto Cut**. Using the auto take-up reel unit when **On** is selected will cause errors.

["Cutting the roll paper" on page 34](#)

Taking Up the Paper Printable Side Out

For information on installing the roll core, see the *Setup Guide* for the optional auto take-up reel unit.

Buttons that are used in the following settings

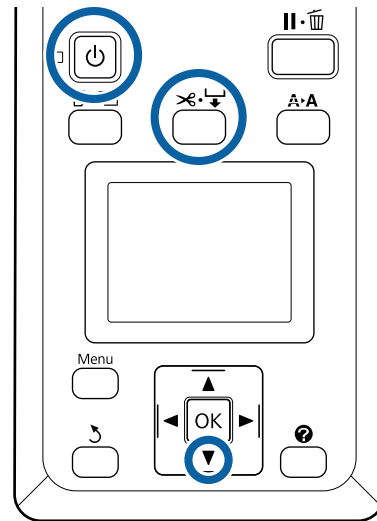

1

Set the auto take-up reel unit Auto switch to Off. Plug the power cord into an outlet and confirm that the power lamp lights.

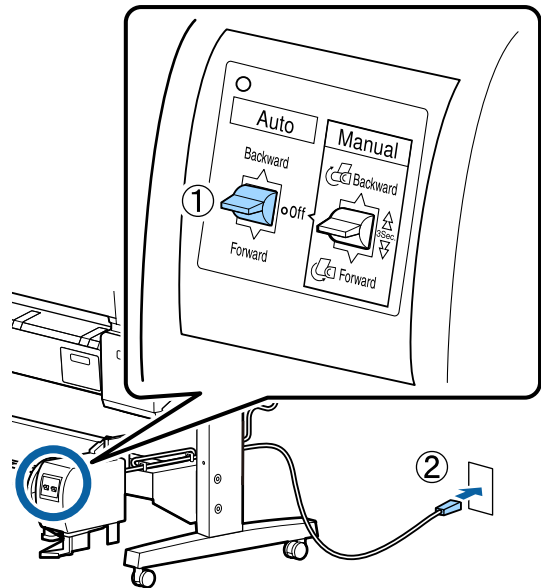

2

Turn on the printer by pressing the button.

3

Check that the roll paper is correctly loaded in the printer.

4

Press the button on the control panel. Keep the button pressed until the end of the roll reaches the roll core.

Basic Operations

- 5** Tape the end to the roll core.

Place tape (available from third-party suppliers) at the center and then at the left and right ends.

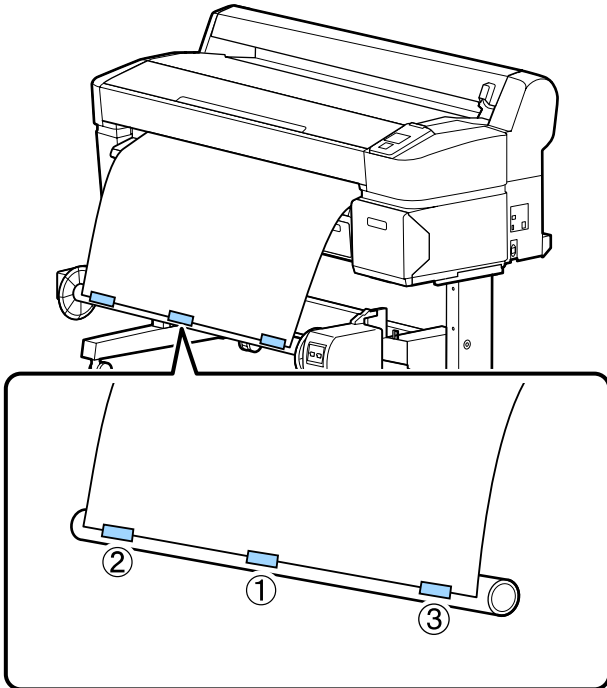

- 6** Keep the ▼ button in the control panel pressed until you have fed enough paper for about three wraps around the roll core.

- 7** Keep the Manual switch pressed to Forward to wrap the paper three times around the core.

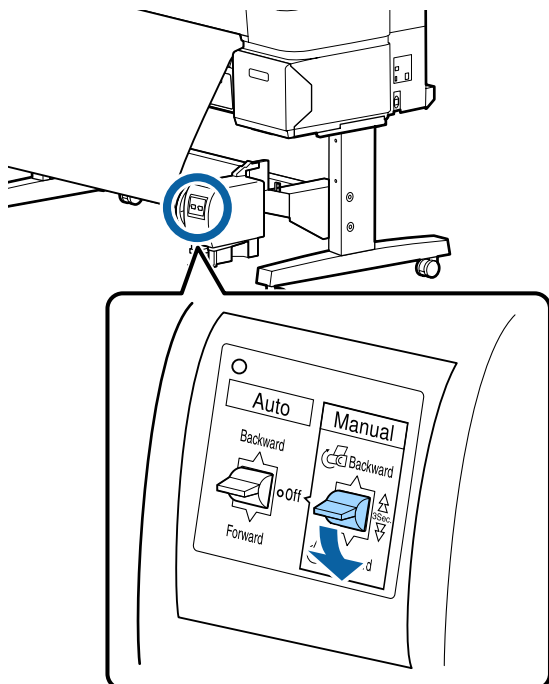

After wrapping the paper around the core, ensure that paper around the core is sufficiently loose.

Note:

The tensioner supplied with the auto take-up reel unit is used with some types of paper. Slacken the paper and insert the tensioner near the center of the paper as shown. See the following section for information on paper that requires the tensioner.

 "Epson Special Media Table" on page 212

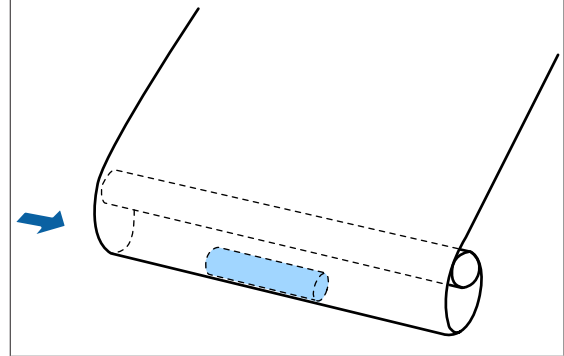

- 8** Set the Auto switch to Forward.

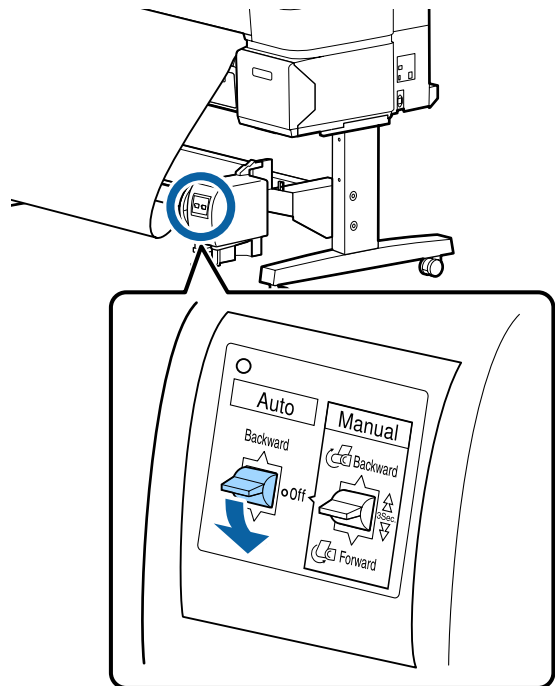

Taking Up the Paper Printable Side In

For information on installing the roll core, see the *Setup Guide* for the optional auto take-up reel unit.

Basic Operations

Buttons that are used in the following settings

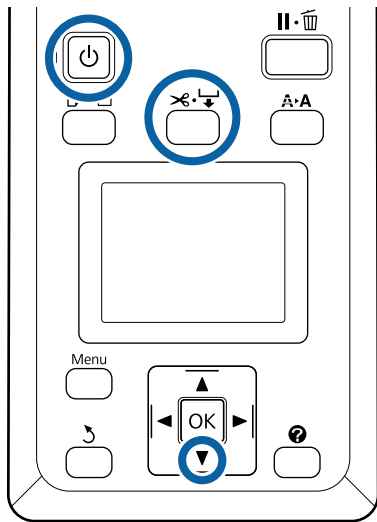

- 1 Set the auto take-up reel unit Auto switch to Off. Plug the power cord into an outlet and confirm that the power lamp lights.

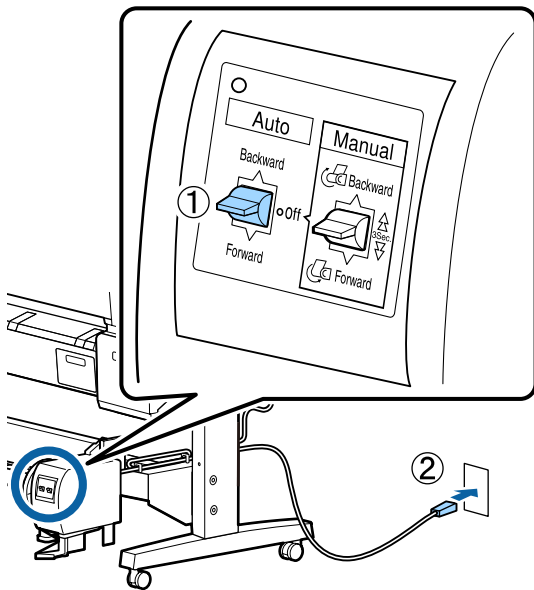

- 2 Turn on the printer by pressing the button.
- 3 Check that the roll paper is correctly loaded in the printer.
- 4 Press the button on the control panel. Keep the button pressed until the end of the roll reaches the roll core.

- 5 Tape the end to the roll core.

Place tape (available from third-party suppliers) at the center and then at the left and right ends.

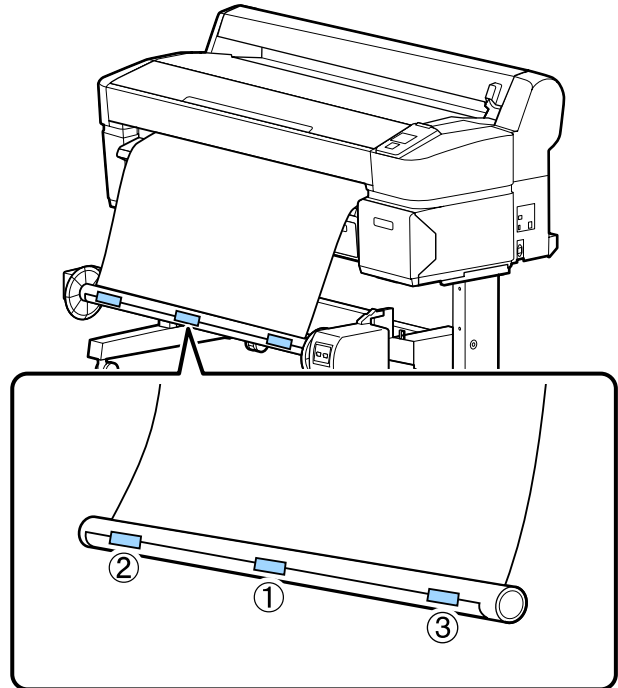

- 6 Keep the button in the control panel pressed until you have fed enough paper for about three wraps around the roll core.

- 7 Keep the Manual switch pressed to Backward to wrap the paper three times around the core.

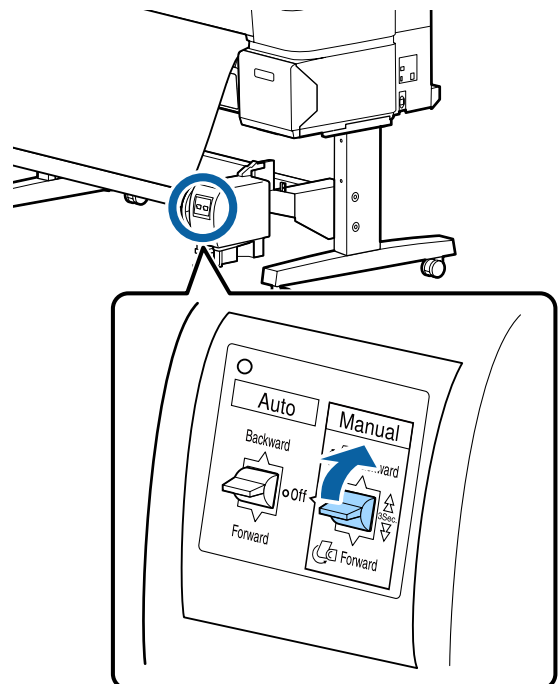

Basic Operations

After wrapping the paper around the core, ensure that paper around the core is sufficiently loose.

- 8** Set the Auto switch to Backward.

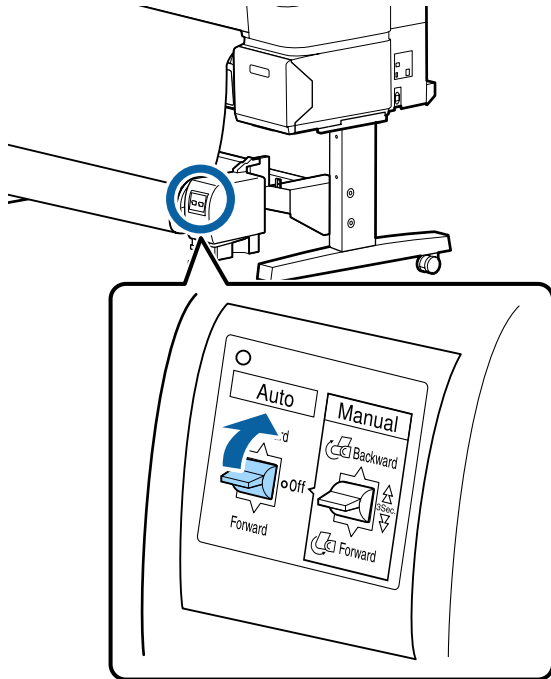

Removing Paper from the Auto Take-up Reel Unit

This section describes how to remove paper from the auto take-up reel unit.



Caution:

Removing paper from the auto take-up reel unit requires two workers, one on each end of the roll.

A single worker working alone could drop the roll, resulting in injury.

Buttons that are used in the following settings

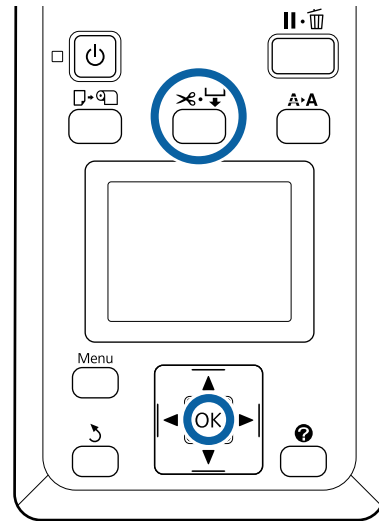

- 1** Set the Auto switch to Off.

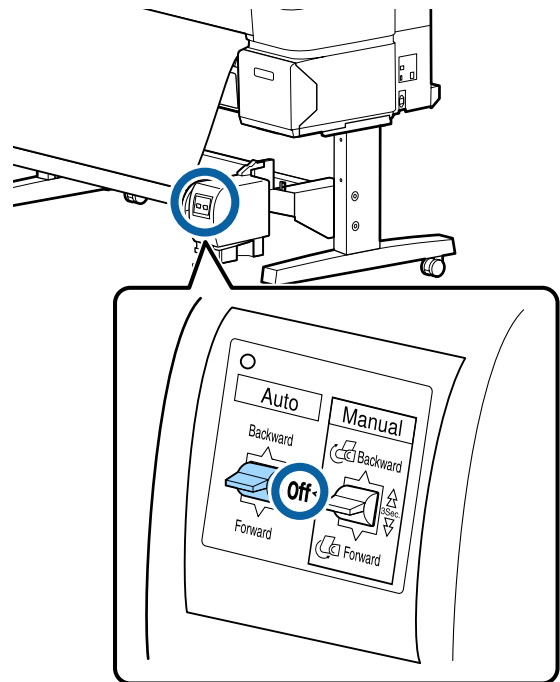

- 2** Cut the paper and take it up until it is all on the auto take-up reel unit roll core.

 [“Manual cut method” on page 35](#)

After cutting the paper, support the end to prevent the printed surface touching the floor; continue to support the paper until it is all taken up. Keep the Manual switch pressed in the take-up direction (either Forward or Backward).

Basic Operations

- 3 Unlock the movable unit and remove it from the roll core.

When removing the movable unit, support the roll core with one hand to prevent it falling to the floor.

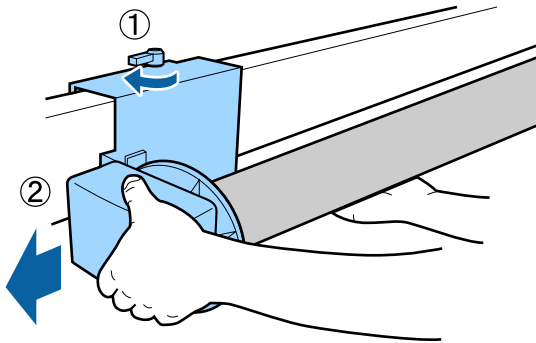

- 4 Remove the roll core from the auto take-up reel unit.

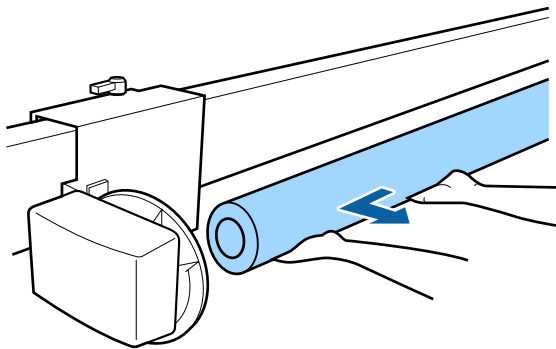

Basic Printing Methods (Windows)

Printing is performed from the application used to create the document you wish to print. The basic procedure is described below.

- 1 Turn on the printer, and load the paper.

[“Attaching the Roll Paper Adapter” on page 29](#)

[“Loading Cut Sheets” on page 39](#)

[“Loading Poster Board” on page 41](#)

- 2 When you have created the data, click **Print** in the **File** menu.

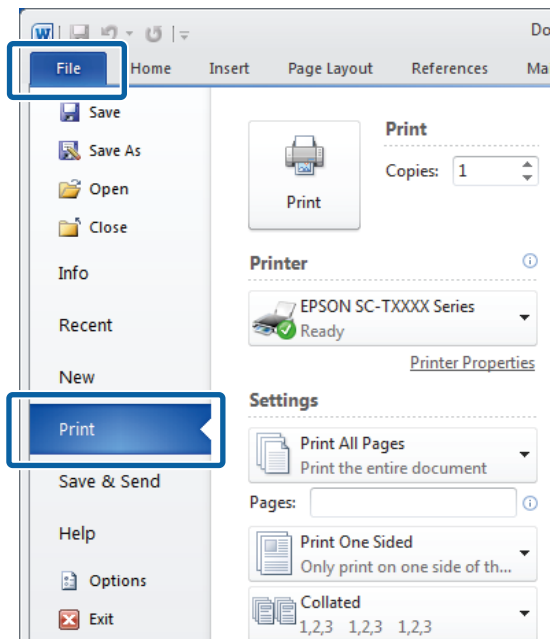

Basic Operations

- After confirming that the printer is selected, click **Printer properties** or **Properties** to display the Printer Settings tab.

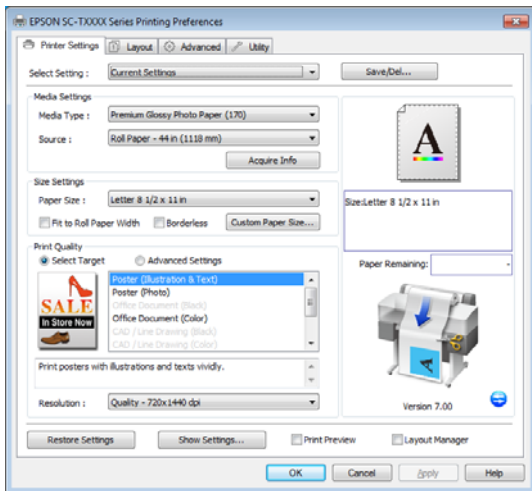

- Check the options selected for **Media Settings**.
When using SC-T7200 Series/SC-T5200 Series/SC-T3200 Series
 On startup, the printer driver automatically downloads information on the media in the printer and displays it in the **Media Settings** area.

To print at current settings, proceed to the next step.

When using SC-T7200D Series/SC-T5200D Series

If **Roll Auto - **mm** has been selected when the printer driver starts, the printer applies the media type and width of the roll paper currently in use on the printer. When the printer starts printing, it switches to the roll paper to be printed in accordance with the **Roll Switch Condition** setting in the Setup menu of the printer.

☞ “Switching Roll Paper Automatically before Printing (SC-T7200D Series/SC-T5200D Series Only)” on page 97

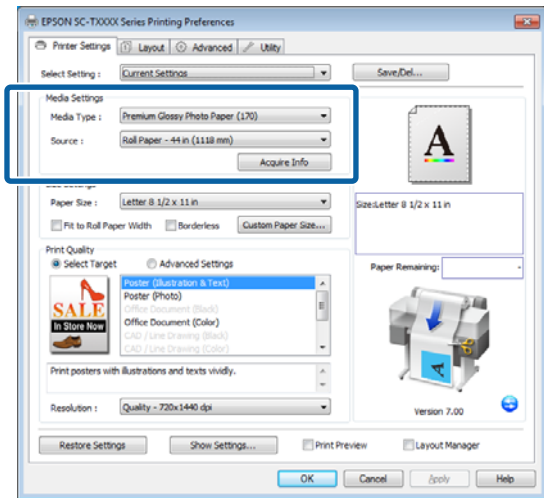

If the desired settings are not displayed, replace the media in the printer with the desired paper type and click the **Acquire Info** button. The driver will reacquire data from the printer and update the information displayed in the **Media Settings** area.

Note:
 If the **Acquire Info** button is clicked, information about the paper loaded on the printer is displayed.

- In the **Size Settings** area, choose the desired **Paper Size**.

Choose the **Paper Size** selected when the document was created in the application.

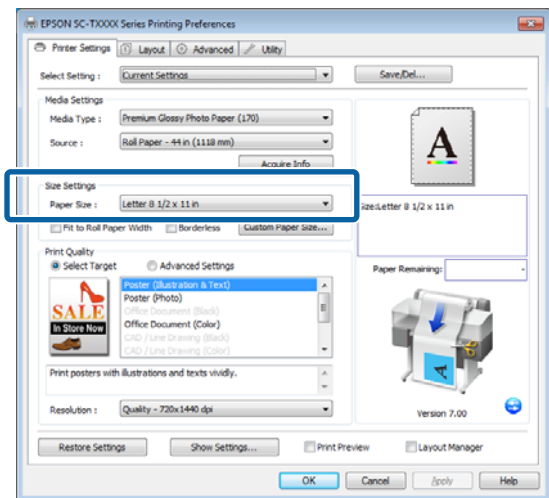

Basic Operations

If the desired size is not available in the menu, click **Custom Paper Size** to add a custom paper size. [“Printing at Non-Standard Sizes” on page 93](#)

6 Select "fit to" and borderless printing options.

To resize the document to fit it to the width of the roll when using roll paper, simply select **Fit to Roll Paper Width**.

To print without borders (margins), select **Borderless**.

For borderless printing on paper larger than the original document size, select both the "fit to" and borderless options.

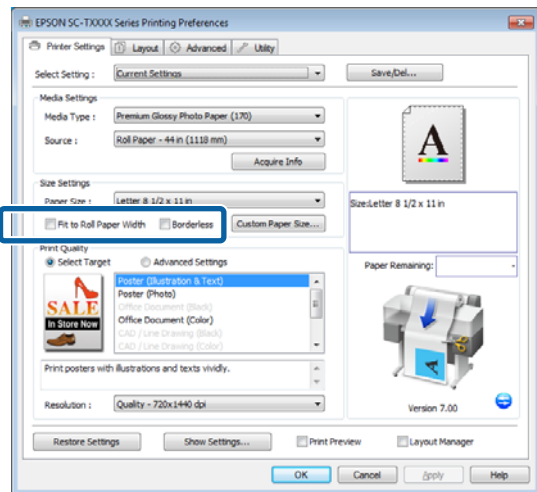

Advanced fit and borderless settings are available in the Layout tab.

[“Enlargements and Horizontal and Vertical Banners” on page 89](#)

[“Borderless Printing” on page 102](#)

7 In the **Print Quality** area, choose an option for **Select Target**.

Choose an option according to the type of document and how it will be used.

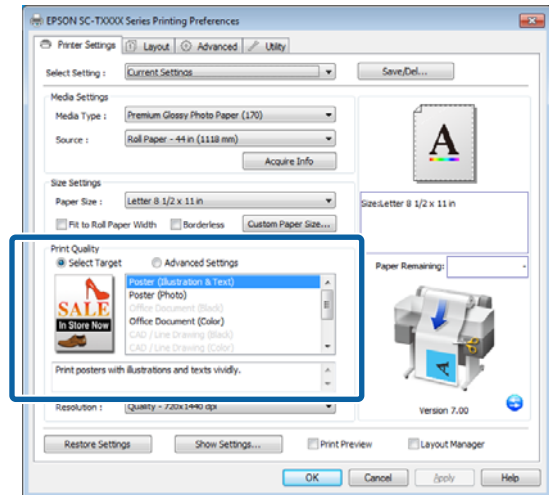

To choose a color correction method or adjust colors, select **Advanced Settings**.

[“Correct color and print” on page 107](#)

8 Check settings.

The selected settings are reflected in the area on the right; check that settings are correct.

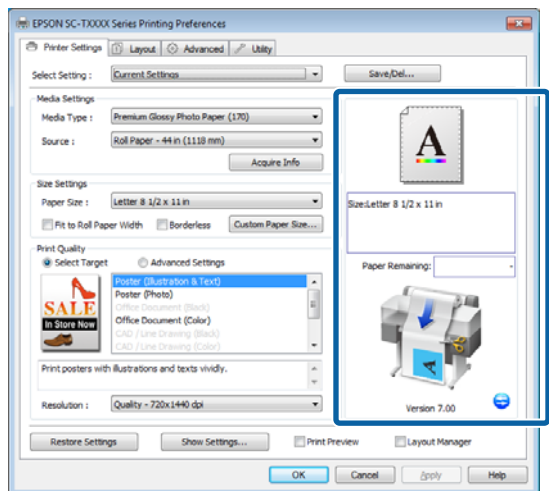

9 Click the **OK** button.

Basic Operations

10 When settings are complete, click **Print**.

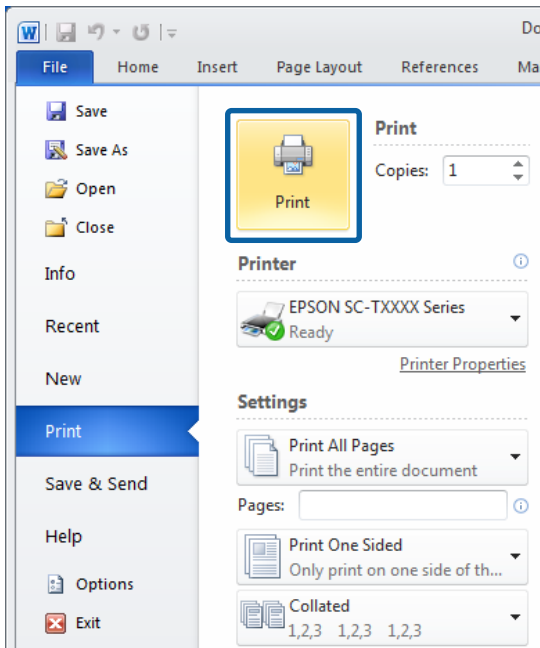

The progress bar is displayed, and printing starts.

Screen while printing

The following screen is displayed when you start printing, and the progress bar (the computer's processing status) is displayed. On this screen you can check the remaining ink level, product numbers for the ink cartridges, and so on.

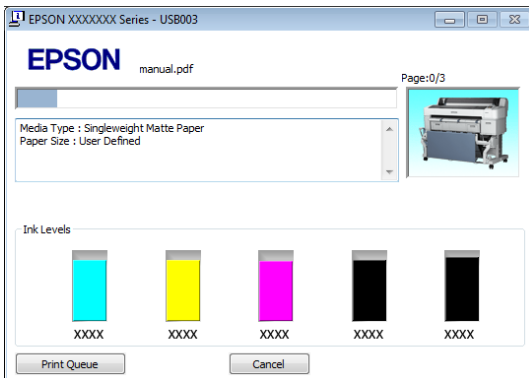

An error message is displayed if an error occurs or an ink cartridge needs replacing while printing.



Basic Operations

Basic Printing Methods (Mac OS X)

1 Turn on the printer, and load the paper.

[“Attaching the Roll Paper Adapter” on page 29](#)

[“Loading Cut Sheets” on page 39](#)

[“Loading Poster Board” on page 41](#)

2 When you have created the data, from the **File** menu of the application, click **Print** and so on.

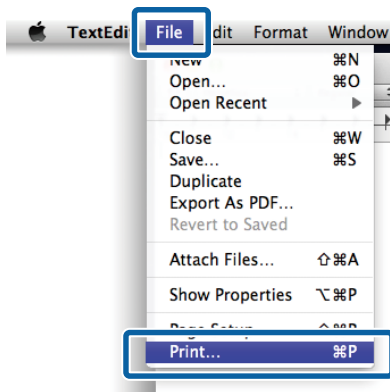

3 The print screen is displayed.

Mac OS X Lion or later

Click **Show Details** at the bottom of the dialog box.

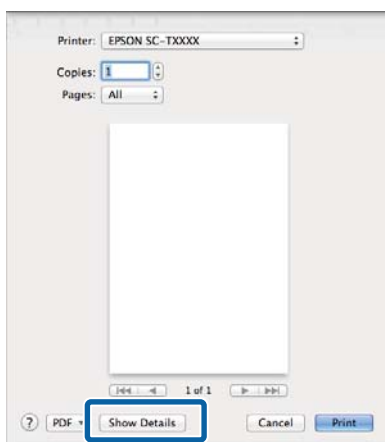

For Mac OS X 10.6 and 10.5, click the arrow () to make settings on the Page Setup screen.

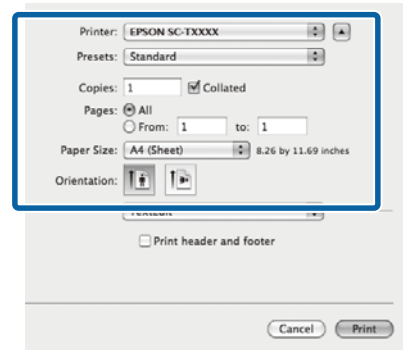
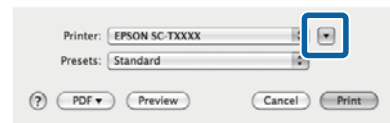

Note:

*If page settings are not displayed in the print dialog, click the "page settings" option (e.g., **Page Setup**) in the **File** menu.*

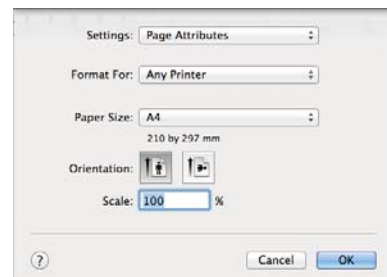

4 Check that this printer is selected, and then set the paper size.

Select one of the following options for **Paper Size**. XXXX is the actual paper size, such as A4.

XXXX: Print with margins on roll paper. Print using the **Roll Paper Margin** selected on the printer. [“Print Queues menu” on page 147](#)

Basic Operations

XXXX (cut sheet): Print with margins on cut sheets. Print with top, right, and left margins of 3 mm and a bottom margin of 14 mm.

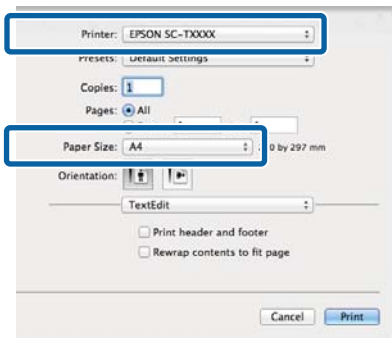

When performing borderless or banner printing; see [“Borderless Printing” on page 102](#), [“Enlargements and Horizontal and Vertical Banners” on page 89](#)

5 To view basic print settings, select **Printer Settings** from the list.

Mac OS X 10.6 or later (when using SC-T7200 Series/SC-T5200 Series/SC-T3200 Series)
On startup, the printer driver automatically downloads information on the media in the printer and displays it in the **Page Setup** and **Media Type** areas. To print at current settings, proceed to the next step.

Mac OS X 10.6 or later (when using SC-T7200D Series/SC-T5200D Series)
If **Auto** has been selected for **Roll Switch** when the printer driver starts, the printer applies the media type and width of the roll paper currently in use on the printer. When the printer starts printing, it switches to the roll paper to be printed in accordance with the **Roll Switch Condition** setting in the Setup menu of the printer.

[“Switching Roll Paper Automatically before Printing \(SC-T7200D Series/SC-T5200D Series Only\)” on page 97](#)

Mac OS X 10.5

Choose **Page Setup** and **Media Type** according to the type of paper loaded in the printer.

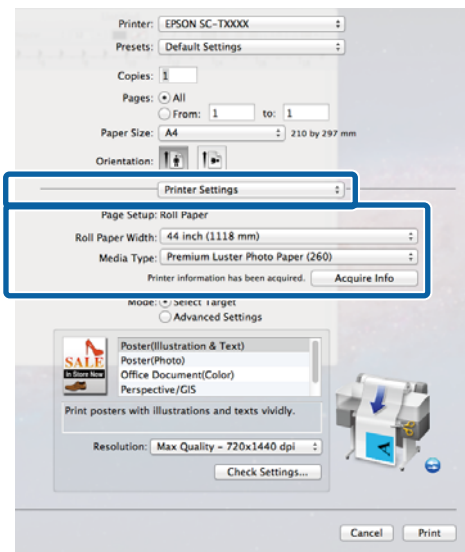

If the desired settings are not displayed, replace the media in the printer with the desired paper type and click the **Acquire Info** button. The driver will reacquire data from the printer and update the information displayed.

6 Choose how the printed document will be used.

Choose an option according to the type of document and how it will be used.

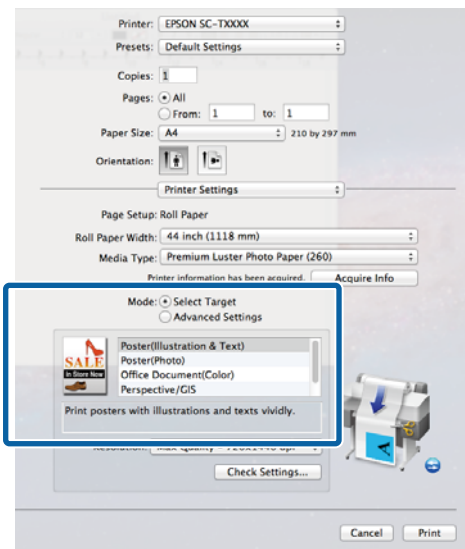

To choose a color correction method or adjust colors, select **Advanced Settings** for **Mode**.

[“Correct color and print” on page 107](#)

Basic Operations

7 Check settings.

The selected settings are reflected in the area on the right; check that settings are correct.

8 When settings are complete, click **Print**.

The printer icon is displayed in the Dock while printing. Click the printer icon to display the status. You can check the progress of the current print job and the printer status information. You can also cancel a print job.

Also, if an error occurs while printing, a notification message is displayed.

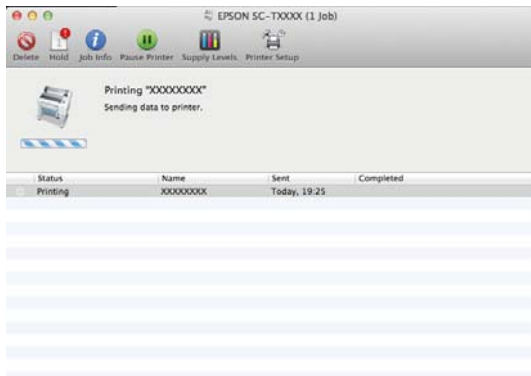

Basic Operations

Printable area

This section describes the printable areas for the printer.

If the margin set in an application is larger than the following setting values, sections beyond the specified margins are not printed. For example, if 15 mm is selected for the left and right margins in the printer menus and the document fills the page, the 15 mm at the left and right sides of the page will not be printed.

Roll Paper Printable Area

The gray area in the illustration below shows the printable area.

When printing borderless on the left and right, the left and right margins are 0 mm. When printing borderless on all edges, all margins are 0 mm.

The arrow in the illustration indicates the direction of the ejected paper.

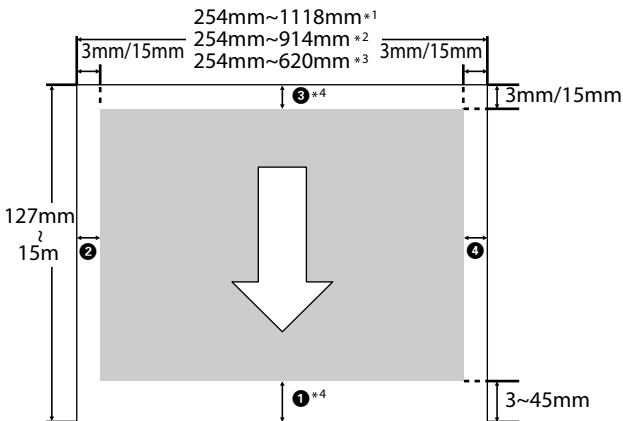

*1 SC-T7200 Series/SC-T7200D Series

*2 SC-T5200 Series/SC-T5200D Series

*3 SC-T3200 Series

*4 If **Banner** is selected for **Roll Paper Option** in the printer driver **Advanced** tab, the top and bottom margins are 0 mm.

Margins for roll paper depend on the option selected for **Roll Paper Margin** in the menus, as shown in the table below.

Roll Paper Margin Settings “Setup menu” on page 154

indicates factory default settings.

Roll Paper Margin Parameter	Margin Values
Normal	①,③=15 mm*
	②,④=3 mm
Top15mm/Bottom15mm	①,③=15 mm
	②,④=3 mm
Top35mm/Bottom15mm	①=35 mm
	③=15 mm
	②,④=3 mm
Top45mm/Bottom15mm	①=45 mm
	③=15 mm
	②,④=3 mm
3 mm	①,②,③,④=3 mm
15 mm	①,②,③,④=15 mm

* When **Normal** is selected, the value for ① is 20 mm for the following paper.

Premium Glossy Photo Paper (250)/Premium Semigloss Photo Paper (250)/Premium Luster Photo Paper (260)/Premium Semimatte Photo Paper (260)

When the following media are used in **CAD / Line Drawing** mode, the value for ① ③ is 3 mm.

Singleweight Matte Paper

Basic Operations



Important:

- ❑ *Printing is distorted when the trailing edge of the roll paper comes off the core. Make sure the trailing edge does not come inside the printing area.*
- ❑ *If the width of the printable area (A) is smaller than the width of the print data (B), the section that protrudes from the width of the printable area (C) is not printed.*

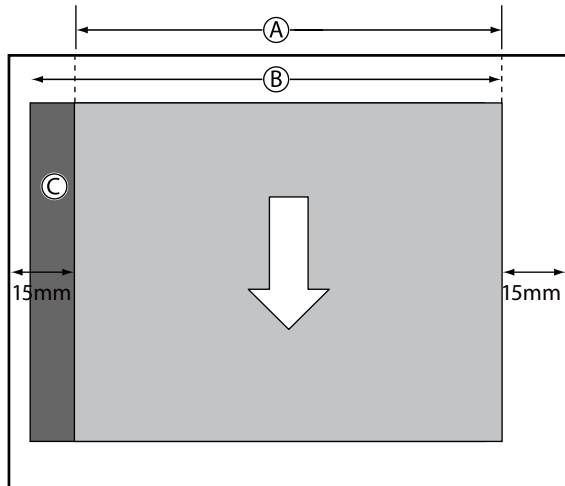

To print everything, either narrow the left and right margins or fit the width of the print data within the printable area.

When the top or bottom margin has been widened, the length of the printing area does not change, but the print length is increased.

*1 SC-T7200 Series/SC-T7200D Series

*2 SC-T5200 Series/SC-T5200D Series

*3 SC-T3200 Series

Cut Sheets Printable Area

When printing borderless on the left and right, the left and right margins are 0 mm. (Borderless printing is not available with poster board.)

The arrow in the illustration indicates the direction of the ejected paper.

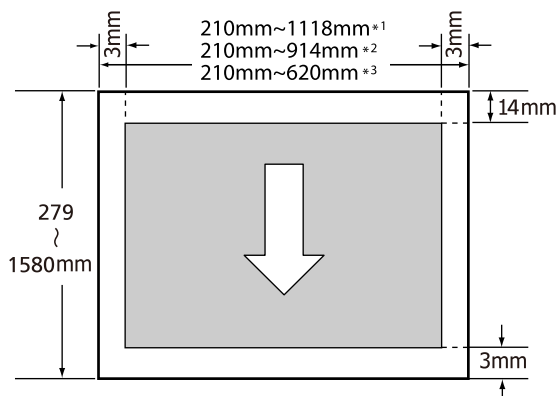

Basic Operations

Turning Off the Power Using Power Off Timer

The printer offers the following two power management options.

❑ Sleep mode

The printer enters sleep mode when there are no errors, no print jobs being received, and no control panel or other operations performed. When the printer enters sleep mode, the control panel's screen turns off and the internal motors and other parts switch off to consume less power.

Sleep mode is cleared if a print job is received or a button on the control panel is pressed.

The delay before the printer enters sleep mode can be selected from values between 5 and 210 minutes. At default settings, the printer enters sleep mode if no operations are performed for 15 minutes. The delay can be changed from the Setup menu. [☞ “Setup menu” on page 154](#)

Note:

When the printer enters sleep mode, the control panel's screen goes blank as if the power has been turned off, but the  light remains lit.

❑ Power Off Timer

The printer is equipped with a Power Off Timer option that automatically turns the printer off if no errors occur, no print jobs are received, and no control panel or other operations are performed for a set period of time. The delay before the printer turns off automatically can be selected from values between 1 and 24 hours in increments of 1 hour.

This section shows the default settings.

❑ SC-T7200 Series/SC-T5200 Series/ SC-T3200 Series

The printer turns off automatically if no errors occur, no print jobs are received, and no operations on the panel or other operations are performed for eight hours or longer.

❑ SC-T7200D Series/SC-T5200D Series

The setting is **Off**.

Power Off Timer settings can be adjusted in the Setup menu. [☞ “Setup menu” on page 154](#)

About Power Management

You can adjust the time before Power Management is applied. Any increase will affect the printer's energy efficiency. Please consider the environment before making any change.

Basic Operations

Canceling Printing

There are a few ways to stop printing operations depending on the situation.

When the computer has finished sending data to the printer, you cannot cancel the print job from the computer. Cancel on the printer.

Canceling from the computer (Windows)

When the Progress Bar is displayed

Click **Cancel**.

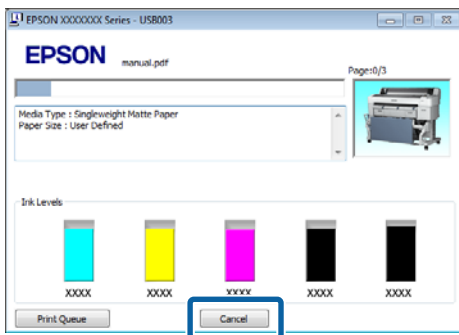

When the Progress Bar is not displayed

- 1 Click the printer icon in the task bar while printing is in progress.

Whether or not an icon is displayed depends on the settings selected for Windows.

- 2 Right click the name of the job you want to cancel and select **Cancel** from the document menu.

To cancel all jobs, click **Cancel All Documents** in the **Printer** menu.

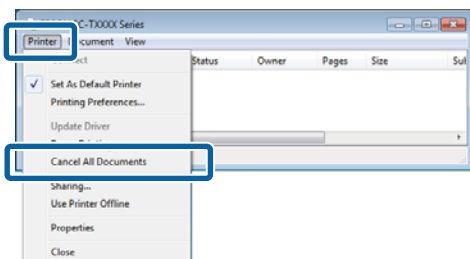

If the job has been sent to the printer, print data is not displayed on the above screen.

Canceling from the computer (Mac OS X)

- 1 Click the printer icon in the Dock.



- 2 Select the job you want to cancel, and then click **Delete**.

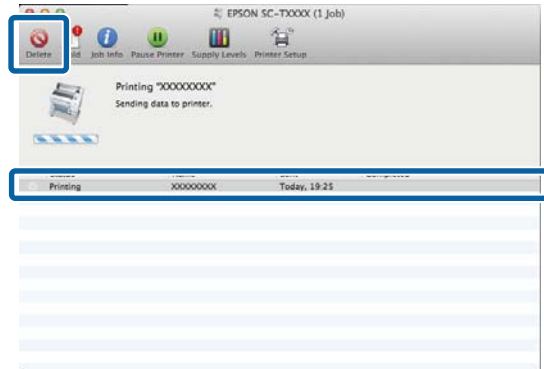

If the job has been sent to the printer, print data is not displayed on the above screen.

Canceling on the printer

Press the  button, select **Job Cancel** on the screen, and then press the **OK** button.

The print job is canceled even in the middle of printing. It may take a while before the printer returns to ready status after canceling a job.

Note:

You cannot delete print jobs which are in the print queue on the computer using the above operation. See "Canceling from the computer" to delete print jobs in the print queue.

Saving to and Reprinting on the Optional Hard Disk Unit

Saving to and Reprinting on the Optional Hard Disk Unit

Function Summary

When an optional hard disk unit or Adobe PostScript 3 Expansion Unit (hereinafter referred to as the hard disk) is installed, print jobs can be viewed and managed as described below.



Important:

An optional hard disk unit for the SC-T7000 Series/SC-T5000 Series/SC-T3000 Series cannot be installed to this printer. Always use a hard disk unit intended for this printer.

[🔗 “Options and Consumable Products” on page 210](#)

Extended functions

Print jobs can be viewed and managed as described below.

- **Viewing Print Jobs**

When there are multiple print jobs with some in the queue, the following information can be displayed.

- Estimated print start time
- Estimated print time
- Other information, including whether the job can be printed without replacing consumables

- **Viewing and Resuming Held Print Jobs (SC-T7200 Series/SC-T5200 Series/SC-T3200 Series only)**

If the source or other settings selected with the printer differ from the settings specified in the print job, an error will occur and printing will be suspended.

When an error occurs, printing cannot be restarted until the printer has been readied by, for example, replacing the paper.

However, the following types of print job can be held temporarily on the hard disk.

Therefore, after printing all the jobs that can be printed with the current paper, you can replace the paper with the media specified in the held print jobs and resume printing, making your work more efficient.

- Print jobs that specify sources that differ from that selected with the printer
- Print jobs that specify paper types that differ from that selected with the printer
- Print jobs that specify output paper sizes (widths) that are larger than that selected with the printer

Note:

*Held print jobs can be saved if **On** is selected for **Store Held Job** in the control panel Setup menu.*

*The factory default setting is **Off**.*

[🔗 “Setup menu” on page 154](#)

- **Viewing and Printing Stored Jobs**

Print jobs can be stored on the hard disk and printed at a later date.

Print jobs selected for printing at a later date can be printed directly on the hard disk without increasing the load on your computer.

Print jobs are saved using the printer driver. [🔗 “Saving Print Jobs” on page 70](#)

Saving to and Reprinting on the Optional Hard Disk Unit

Note:

- Large copy and enlarged copy print jobs created with an optional MFP Scanner or a commercially available scanner connected to the printer cannot be saved to the hard disk.
- Jobs printed with the following applications are always saved to the hard disk.

For information on other applications, see the software documentation or online help.

- LFP Print Plug-In for Office
- EPSON CopyFactory5

Print Job Management

- **From the Print Job menu of the Control Panel**
Detailed procedure [↗](#) “Viewing, Printing and Deleting Saved Print Jobs” on page 71

- **From Remote Manager**

The Remote Manager utility is included in the standard install of the printer network interface and, in addition to managing the print jobs stored on the hard disk, can be used for viewing printer status and adjusting network settings. Enter the IP address specified for the printer in the address bar of the web browser you are using on your computer and start the software.

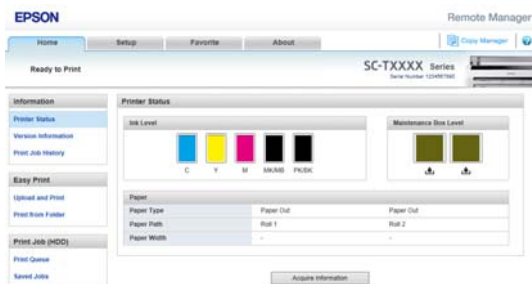

When managing in the Remote Manager, you can cancel jobs waiting to be printed individually and cancel and resume held jobs individually.

For more information, see the online help for Remote Manager.

How to start Remote Manager [↗](#) “How to use Remote Manager” on page 27

- **From LFP HDD Utility (Windows only)**

The LFP HDD Utility can be used to manage print jobs stored on a hard disk. It is used when the printer is connected to the computer via USB.

It can be downloaded from the Epson website.

<https://www.epson.com>

Data on a Hard Disk

Data on a hard disk cannot be copied to a computer or other device. Even when print jobs have been stored on the hard disk, save the original data on a computer.

Data on a hard disk may be lost or corrupted in the following situations.

- When the disk is affected by static electricity or electrical noise
- When the disk has been used incorrectly
- After a malfunction or repair
- When the disk was damaged by a natural disaster

We take no responsibility for any data loss, data corruption, or other problems due to any cause, even including those listed above and within the warranty period. Be aware that we are also not responsible for the recovery of lost or corrupted data.

Saving Print Jobs

This section describes the print driver settings used to save print jobs.

Saving to and Reprinting on the Optional Hard Disk Unit

1 When you have created the data, click **Print** in the **File** menu.

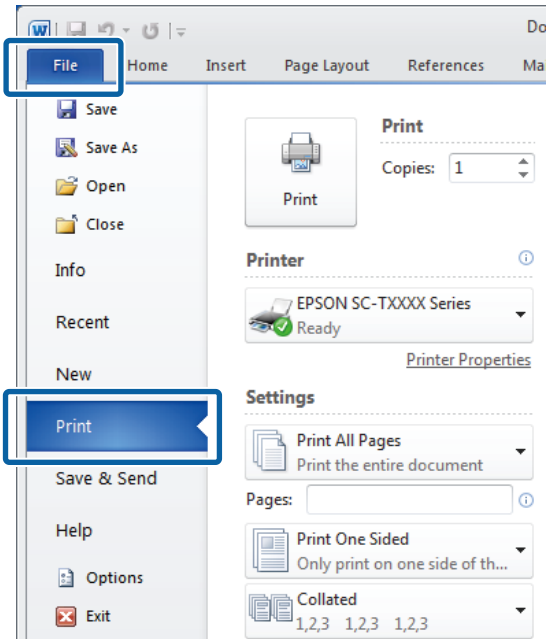

2 After confirming that the printer is selected, click **Printer properties** or **Properties** to display printer settings.

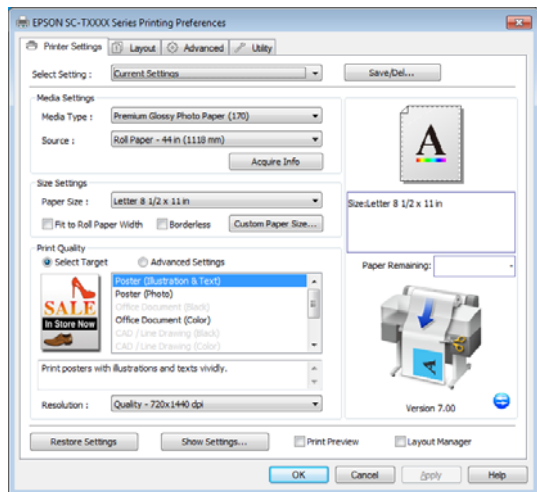

3 In the **Advanced** tab, click the **Settings** button in the **Hard Disk Unit** area and select **Print and Save** or **Save only**.

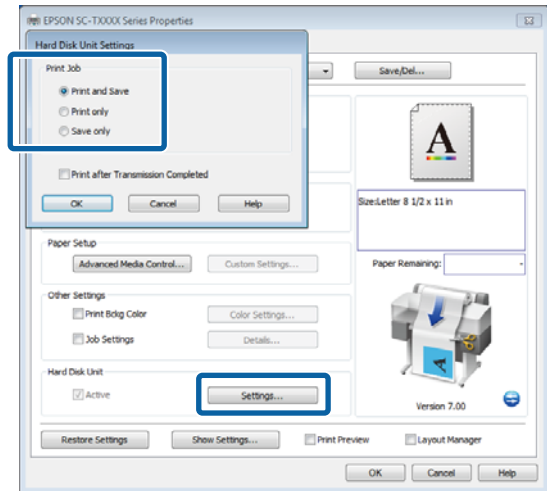

4 Next, print the document normally.

If **Save only** is selected, the print job will be saved to the optional hard disk unit but not printed.

Viewing, Printing and Deleting Saved Print Jobs

This section describes how to view, print and delete saved jobs from the control panel.

Buttons that are used in the following settings

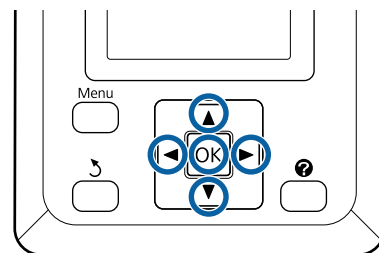

1 Confirm that the printer is ready to print. Press the ◀▶ buttons to select and press the OK button.

The Print Queues menu will be displayed.

Saving to and Reprinting on the Optional Hard Disk Unit

- 2 Press the ▼/▲ buttons to highlight **Stored Job** and press the OK button.

The print job tab info display area shows the names of stored print jobs.

- 3 Press the ▼/▲ buttons to select a job to print or delete and press the OK button.

After selecting a file name, you can check the thumbnail by pressing the ► button.

If you are unsure of the file name, you can confirm the target file in the thumbnail. In the thumbnail screen, press the OK button to display detailed information about the file.

There may not be a thumbnail saved for some files. If this is the case, the detailed information about the selected file is displayed.

- 4 Press the ▼/▲ buttons to select **Print** or **Delete** and press the OK button.

When **Delete** is selected, a confirmation screen appears. Press the OK button to delete the job.

When reprinting, a screen appears to enter the number of copies. Proceed to Step 5.

- 5 Press the ▼/▲ buttons to choose the number of copies and press the OK button.

Copying and Scanning

Copying and Scanning

Large Copying and Large Scanning using the MFP Scanner (Option)

Function Summary

Main Functions

If you connect the optional MFP Scanner, you can use the following functions.

Large Copy

If you connect the optional MFP Scanner to the SC-T7200 Series/SC-T5200 Series/SC-T7200D Series/SC-T5200D Series, you can load documents up to 36 inches and make large copies.

Large Scan

To perform a large scan, in addition to connecting the MFP Scanner, you need the optional hard disk unit or Adobe PostScript 3 Expansion Unit (hereinafter referred to generally as the hard disk).

You can select the format in which to save the scanned images from the following.

- JPEG file
- PDF file
- TIFF file

You can select where to send or save the file from the following.

- Attached to e-mails, and then sent to another printer.* (Scan To e-mail)
- Saved to a shared folder on the network. (Scan To Shared Folder)

- Saved to a hard disk installed to a printer connected to the MFP Scanner that performed the scan. (Scan To HDD)

* The destination printer must have a MFP Scanner and a hard disk installed. To confirm whether this function is supported, see the manual included with the printer.

Operation

You can perform large copy/scan operations or manage scanned image files in the following locations.

- On the Large Copy/Large Scan screen of the control panel

See the following procedure for detailed instructions.

- From Copy Manager

You can use the Copy Manager software to copy and scan on a tablet terminal or computer connected to the printer via the network.

Starting Copy Manager  [“How to start Copy Manager” on page 74](#)

Function compatibility chart

The following chart shows available functions by tool.

	Control panel	Copy Manager
Large Copy	✓	✓
Large Scan*1	✓	✓

Copying and Scanning

	Control panel	Copy Manager
Scan To e-mail	✓	✓
Receive e-mail	✓	✓
Scan To Shared Folder	✓	✓
Scan To HDD	✓	✓
Operations for image files that were scanned or received by e-mail*2, *3		
Print*4	✓	✓
Thumbnail display	✓	✓
Send as an e-mail attachment	✓	✓
Send to a folder	✓	✓
Download file	-	✓
Delete	✓	✓
Add or edit e-mail destination addresses	_*5	✓
Add or edit shared folder addresses	_*5	✓
Check file operation history	-	✓
Scanner maintenance		
Eject Direction	✓	-
Calibration	✓	-
Feed Adjust	✓	-
Scan Speed	✓	-

*1 Available only when the optional hard disk unit or Adobe PostScript 3 Expansion Unit has been installed.

*2 In the case of Scan To e-mail and Scan To Shared Folder as well, all scanned image files are saved to the hard disk of the printer.

*3 Operation is possible whether the optional MFP scanner is installed or not.

*4 You can only print PDF files and TIFF files when the optional Adobe PostScript 3 expansion unit is installed.

*5 If **Reset All Settings** or **Secure (Quick)** or **Secure (Sanitizing)** of **Format HDD** in the **Administrator Menu** of the settings menu is performed, all content that has been added to the address book is deleted.

How to start Copy Manager

Copy Manager is equipped with the printer's network interface and functions if one of the following is installed to the printer.

- MFP scanner
- Hard disk unit
- Adobe PostScript 3 expansion unit

However, if the MFP Scanner is not installed, you cannot use the large copying and large scanning functions.

The following procedure describes how to start Copy Manager.

- 1** Start a web browser on a tablet terminal or computer connected to the printer via the network.
- 2** Enter the IP address specified on the printer in the address bar, and then press the Enter key or the return key.
- 3** In the displayed screen, click Copy Manager.

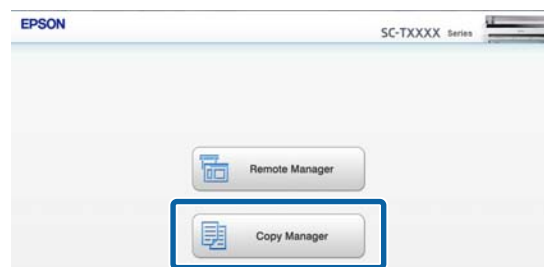

The printer does not have a wireless LAN function. To connect the printer and a tablet terminal over the network, you need a wireless LAN router or wireless LAN access point.

Copying and Scanning

Example

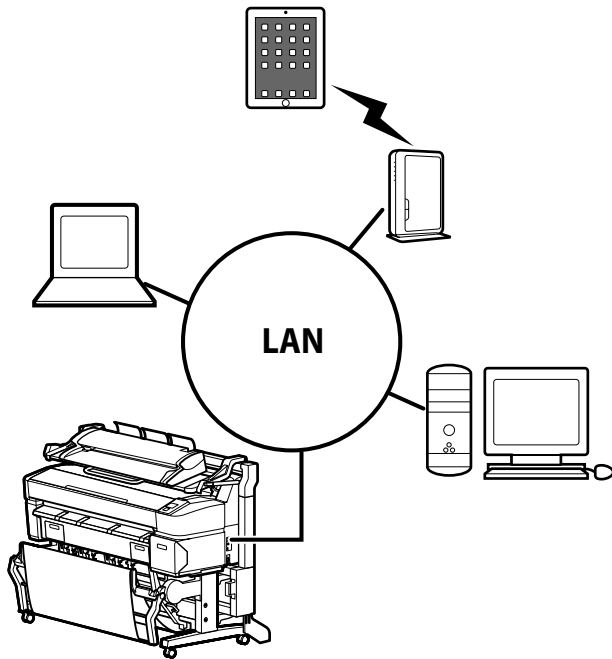

For supported operating systems and browsers, see the following section.

[“System Requirements” on page 225](#)

Preparing to Scan

Do the following settings in advance to do "Scan to e-mail" or "Scan To Shared Folder".

Mail Server Settings

Configure settings with Remote Manager.

[“Mail Server Settings” on page 75](#)

Register email destination addresses and shared folder addresses

Configure settings with Copy Manager.

[“Creating and Editing the Address Book” on page 75](#)



Important:

If you use the "Scan to e-mail" or "Scan To Shared Folder" functions or do operations from Copy Manager without configuring the security settings, problems may occur, including the interception or falsification of information.

We recommend that before you use the product, you sufficiently understand the problems that can occur during operation without configuring security settings, and then configure the security settings at your own discretion and responsibility.

Mail Server Settings

Use Remote Manager to configure the mail server settings (SMTP/POP3). As with Copy Manager, Remote Manager is included in the software installed in the network interface of the printer.

The following procedure describes how to start Copy Manager.

- 1 Start a web browser on a tablet terminal or computer connected to the printer via the network.
- 2 Enter the IP address specified on the printer in the address bar, and then press the Enter key or the return key.
- 3 In the displayed screen, click **Remote Manager**.
- 4 Open the Setup tab screen, and then click **Mail** in the menu on the left side of the screen.

See the online help for more details on Remote Manager.

Creating and Editing the Address Book

Use Copy Manager to create and edit the address book in which to register email destination and shared folder addresses.

- 1 Start Copy Manager.
- 2 In the upper part of the screen, click the **Settings** icon.

Copying and Scanning

See the help for more details on Copy Manager functions.

Note:

In the case of e-mail destination addresses and shared folders addresses that have been added to the address book, delete each item individually by editing the address book.

*To delete the entire address book, perform **Reset All Settings** or **Secure (Quick)** or **Secure (Sanitizing)** of **Format HDD** in the **Administrator Menu** of the settings menu of the printer.*

Notes on Loading Documents in the Scanner

This section describes the document widths and paper types that can be loaded and documents that cannot be loaded.



Important:

If a document covered in dust is loaded, the dust may adhere inside the MFP Scanner and decline the quality of copied or scanned images. Before loading a document in the scanner, remove any dust from the document.

Width of documents that can be loaded

152 to 914 mm (6 to 36 inches)

Document paper types that can be loaded

- Plain Paper
- Recycled Paper
- Tracing Paper
- Matte film
- Blueprint copy, diazo type (blue lines on white base)
- Blueprint copy, negative image (white lines on blue base)
- Matte paper for ink jet printers

- Synthetic paper
- Newspaper
- Advertisement paper
- Photopaper
- * When loading a thin document, we recommend placing it between clear holders or other similar objects.

Documents that cannot be loaded

Do not load the following documents. Failure to observe this precaution could cause paper jams or damage the scanner.

- Documents with creases or wrinkles
- Documents with bindings
- Documents with curls
- Documents with carbon backing
- Documents with staples, paper clips, or glue attached
- Documents with many holes, such as loose leaf paper
- Documents with irregular shapes or not cut at right angles
- Documents with photos, stickers, or labels attached
- Transparent documents
- Glossy documents
- Deteriorated documents
- Documents with rips

When you load a document that is more than 0.25 mm thick

Before loading a document in the scanner, do the following three things.

Copying and Scanning

Remove the paper eject guides

If the paper eject guides are left attached, the document will strike them and not be ejected.

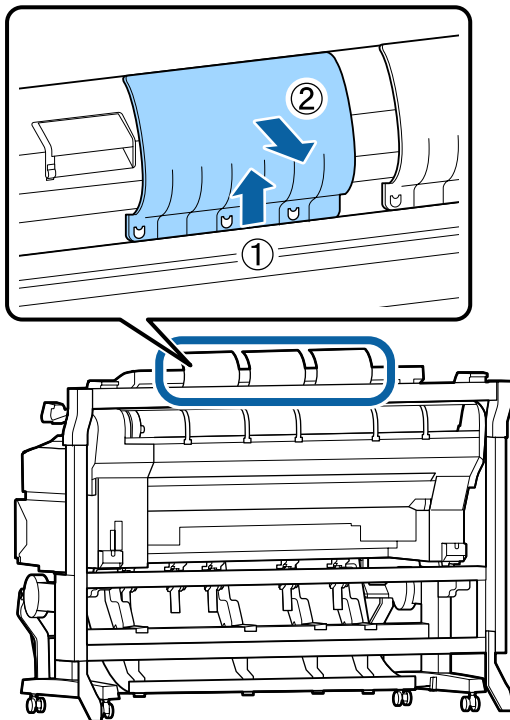

Set the document eject direction to forward

If the document is ejected backward with the paper eject guides removed, the document will fall to the rear side and be damaged by folding.

 [“How to change the document eject direction and scanning accuracy” on page 78](#)

Ensure there is space to the front and back

When the document is read, it is pushed out forward and backward. The approximate amount of space required is shown below. If the printer is set up near a wall, make sure there is enough space at the rear.

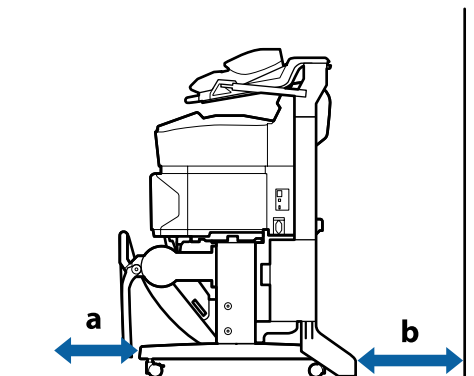

Paper Size	Forward (a)	Backward (b)
A2	185mm	220mm
A1	432mm	467mm
24 × 30 inch	353mm	388mm
30 × 40 inch	607mm	642mm

How to Load Documents

- 1 Align the loading guide with the document loading position.

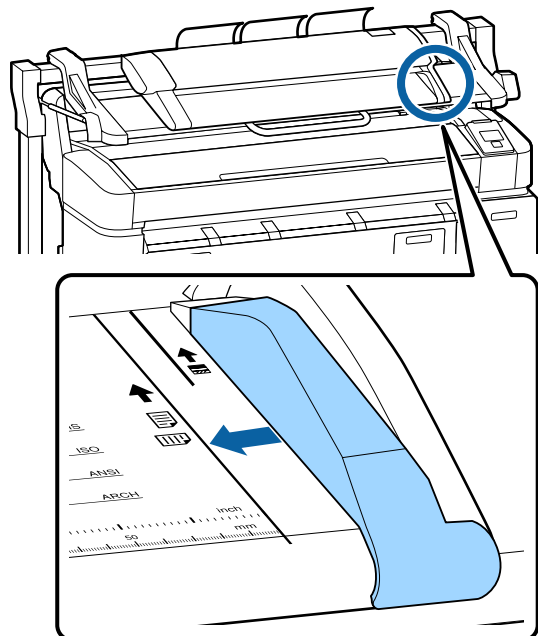

Copying and Scanning

- 2** To ensure that the document is not fed on an angle, we recommend inserting the long side of the document.

With the side of the document to be read facing up, align the right edge of the document with the loading guide.

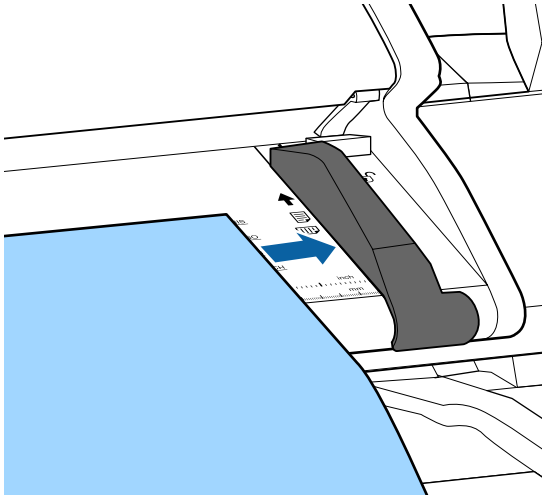

- 3** Insert the document horizontally so that the entire edge touches all inner rollers.

If the edge touches the roller, the document is fed to the read start position automatically. After automatic loading starts, release your hand and do not obstruct the loading of the document.

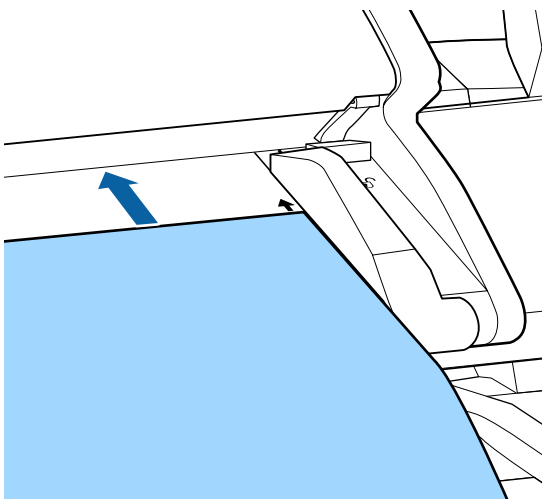

- 4** After the document has been loaded, remove the loading guide, and then make sure the left edge of the document and the guide line are aligned.

If the document is copied or scanned with the loading guide still attached, the edge of the document may be damaged.

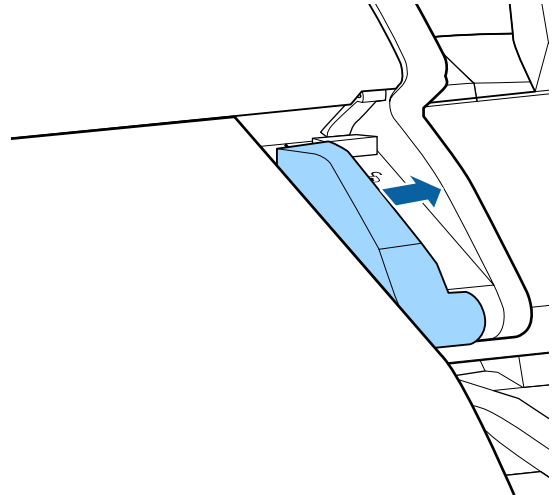

! Important:
If the document slants greatly from the guide line, the slanted and protruding section is not copied or scanned. Press the ► button to eject the document, and then reload the document.

Note:
If the document is 1 m or longer, support it with your hands so that it does not slant during reading.

How to change the document eject direction and scanning accuracy

The procedure to change the document eject direction and to change to a higher scanning accuracy is described below.

Note:
If you change the document eject direction to backward, attach the paper eject guides before use. If the document is ejected backward while the paper eject guides are not installed, the document may be damaged if it falls to the back and gets dirty or creased.

Copying and Scanning

Buttons that are used in the following settings

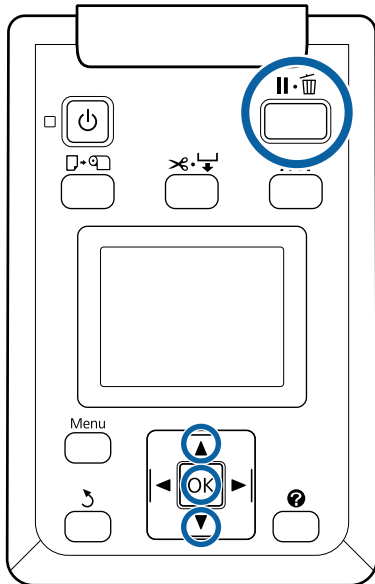

- 1 At Large copy/Large scan screen, use the ▼/▲ buttons to select **Scanner Maintenance** and press the OK button.
- 2 Press the ▼/▲ buttons to select **Eject Direction** or **Scan Speed** and press the OK button.
- 3 Use the ▼/▲ buttons to select the desired option and press the OK button.
- 4 Press the II·🗑️ button to exit.

Large Copying

This section describes the procedure to copy on the control panel of the printer.

Copies are printed along the following loading paths depending on the model you are using.

- ❑ SC-T7200 Series/SC-T5200 Series/SC-T3200 Series
Loaded roll paper or cut sheet
- ❑ SC-T7200D Series/SC-T5200D Series
Select a **Source** for the **Copy Settings** from **Roll 1**, **Roll 2**, **Roll Auto**, or **Cut Sheet**

Buttons that are used in the following settings

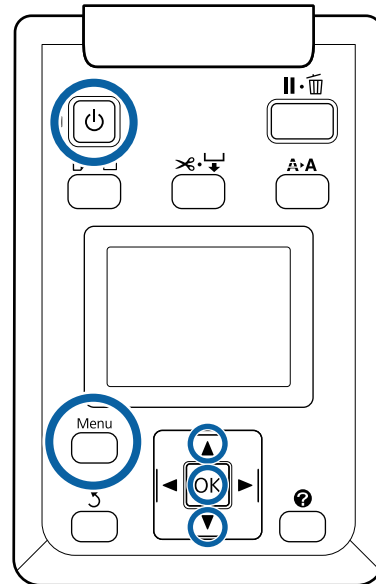

- 1 Turn on the printer by pressing the ⏻ button.
When the printer is turned on, the scanner is also turned on.
- 2 Load paper suitable for large copying on the printer.
[🔗 “Epson Special Media Table” on page 212](#)
- 3 Load document on the scanner.
[🔗 “When you load a document that is more than 0.25 mm thick” on page 76](#)
- 4 Make sure that the Large copy/Large scan screen appears.
If another screen appears, use the ◀▶ buttons to select the 🗑️+ tab.
- 5 At Large copy/Large scan screen, use the ▼/▲ buttons to select **Copy** and press the OK button.
The Large copy screen appears.

Copying and Scanning

- 6** On the Large copy screen, you can press the ▼/▲ buttons to set the number of copies. Press the OK button to start copying.

To change the copy settings or enlargement ratio, press the Menu button to display the Copy settings menu. When the MFP Scanner is installed on the SC-T7200D Series/SC-T5200D Series, you can specify the paper on which to print (Roll 1, Roll 2, Roll Auto, or Cut Sheet) in the Copy Settings menu, too.

Using the Copy Settings menu [☞](#) “Menu Operations” on page 136

Settings [☞](#) “Large Copy / Large Scan menu” on page 174

- 7** When copying has finished, the screen returns to the one in step 6. Press the ► button to eject the document. When the OK button is pressed after loading a document, copying can continue.

After copying has finished, always eject the document. If the next document is loaded with the previous document still inside, the next document cannot be fed correctly.

You can change the eject direction of the document. Changing the eject direction [☞](#) “How to change the document eject direction and scanning accuracy” on page 78

Large Scan

You must do the settings in advance to do "Scan to e-mail" or "Scan To Shared Folder".

[☞](#) “Preparing to Scan” on page 75

This section describes the procedure to scan on the control panel of the printer.

Buttons that are used in the following settings

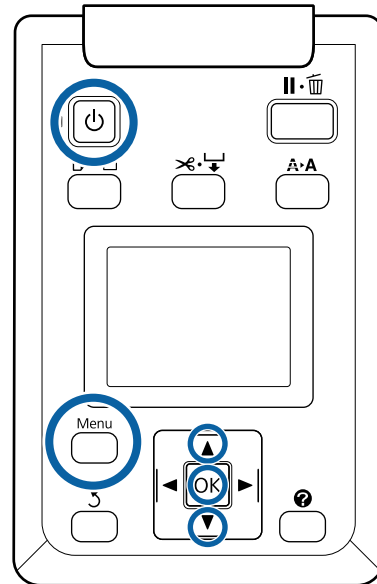

- 1** Turn on the printer by pressing the ⏻ button.
When the printer is turned on, the scanner is also turned on.
- 2** Load paper suitable for the large scan function of the printer.
[☞](#) “Epson Special Media Table” on page 212
- 3** Load document on the scanner.
[☞](#) “When you load a document that is more than 0.25 mm thick” on page 76
- 4** Make sure that the Large copy/Large scan screen appears.
If another screen appears, use the ◀▶ buttons to select the 📄+ tab.
- 5** At Large copy/Large scan screen, use the ▼/▲ buttons to select **Scan** and press the OK button.
A screen appears to select the save/send destination of the scanned file.
- 6** Use the ▼/▲ buttons to select save/send destination and press the OK button.
If the **HDD** was selected, proceed to Step 8.

Copying and Scanning

If **Shared Folder** or **Send By Mail** was selected, proceed to Step 7.

7 Use the ▼/▲ buttons to select the save destination folder or address, and then press the OK button.

8 The details of the main scan settings appear. When the OK button is pressed, scanning starts.

To change the settings, press the Menu button to display the Scan Setting menu.

Using the Scan Setting menu  “Menu Operations” on page 136

Settings  “Large Copy / Large Scan menu” on page 174

9 When scanning has finished, the screen returns to the one in Step 8. Press the ► button to eject the document. When the OK button is pressed after loading the document, you can continue saving or sending scanned files to the same save/send destination.

After scanning has finished, always eject the document. If the next document is loaded with the previous document still inside, the next document cannot be fed correctly.

You can change the eject direction of the document. Changing the eject direction  “How to change the document eject direction and scanning accuracy” on page 78

Operations for Image Files that were Scanned or Received

You can perform the following operations for scanned files or scanned files that were sent by e-mail from another printer.

You can execute this function whether the optional MFP scanner is installed or not.

Print

You can only print PDF files and TIFF files when the optional Adobe PostScript 3 expansion unit is installed.

Furthermore, printing is carried out along the following loading paths depending on the model you are using.

- SC-T7200 Series/SC-T5200 Series/SC-T3200 Series

Loaded roll paper or cut sheet

- SC-T7200D Series/SC-T5200D Series

Select a **Source** for the scan to print settings from **Roll 1**, **Roll 2**, **Roll Auto**, or **Cut Sheet**.

- Send as an e-mail attachment
- Send to a shared folder on the network
- Delete a file

Buttons that are used in the following settings

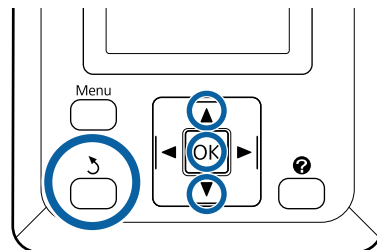

1 Select the  or  tab icon.

When the optional hard disk unit or Adobe PostScript 3 Expansion Unit is installed, then  appears in the tab even if the optional MFP is not installed to the printer. Copying and scanning cannot be done, but the following operations can be done.

- Rcvd Scan File Option*
- Receive New Scan File
- Scan File Options*

Copying and Scanning





* Displayed when a received scan file or a scan file is saved to the hard disk.

If a value such as (3) appears in **Rcvd Scan File Option**, the value indicates the number of unprinted files in the received files that can be printed.







2 Press the ▼/▲ buttons on the Large copy/Large scan screen and select **Rcvd Scan File Option** or **Scan File Options**, and then press the OK button.

A list of selected files appears. The following chart shows the meaning of the icons beside the file names.

When Rcvd Scan File Option is selected

	This is an unprinted file. If printed even once, the icon changes to  .
	This file cannot be printed*.
	This file has been printed.

When Scan File Options was selected

	Indicates an image file that was sent to a shared folder. This file cannot be printed*.
	Indicates an image file that was sent to a shared folder. This file can be printed.
	Indicates an image file that was saved to a hard disk. This file cannot be printed*.
	Indicates an image file that was saved to a hard disk. This file can be printed.
	Indicates an image file that was sent by e-mail. This file cannot be printed*.
	Indicates an image file that was sent by e-mail. This file can be printed.

*You can only print PDF files and TIFF files when the optional Adobe PostScript 3 expansion unit is installed.

3 Use the ▼/▲ buttons to select the file you want to operate.

If it is difficult to understand from just the file name, press the ► button.

You can look at the thumbnails of the scanned images to check the content.

Note:

- Only the top part of the image may appear in the thumbnail, depending on the size of the image.
- In the thumbnail screen, press the ► button to display detailed information about the file.

4 Press the OK button.

When a file with  displayed is selected in **Rcvd Scan File Option** and you press the OK button, printing starts.

If another file was selected, proceed to Step 5.

5 Use the ▼/▲ buttons to select the operation you want to carry out and press the OK button.

If **Print** or **Delete** was selected, check the screen display and carry out the operation.

When **Send To Shared Folder** or **Send by Mail** has been selected, a screen appears to select the save destination folder or send destination. Follow the same operations as when scanning.

6 When the operation has been completed, the screen returns to the file list screen. Press the ⏪ button to exit.

Copying and Scanning

Making Enlarged Copies with a A3 or A4 Scanner

Connecting an Epson A3 or A4 scanner to the printer makes creating enlarged copies a snap; no computer is required.

Supported scanners are listed on the Epson website.

<https://www.epson.com>

Supported Sizes

Scanned document size: 4x6 - A3*1

Output size: Up to A2 or 36 inches (approximately 914 mm)*2

*1 Varies with the model of scanner connected.

*2 Up to 24 inches (approximately 610 mm) with the SC-T3200 Series.

Connecting the Scanner

- 1 Ready both the printer and the scanner.
For information on setting up the scanner, see the documentation supplied with the device.
- 2 Turn the printer and scanner off.

- 3 Connect the scanner to the printer using the cable supplied with the scanner.

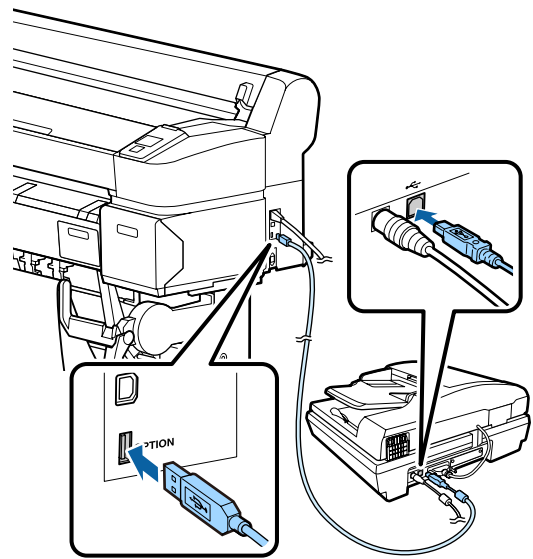

Important:
Connect the scanner directly to the printer. Enlarged copies are only available when the scanner is connected directly to the printer.

Making Enlarged Copies

Copy results are printed along the following loading paths depending on the model you are using.

- ❑ SC-T7200 Series/SC-T5200 Series/SC-T3200 Series
Loaded roll paper or cut sheet

- ❑ SC-T7200D Series/SC-T5200D Series



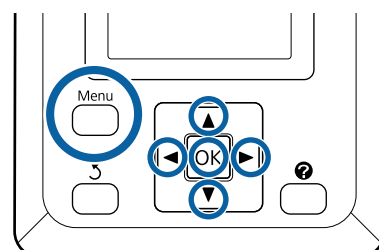

Currently selected roll paper or cut sheet

You can check the paper currently selected by selecting the  tab.

Buttons that are used in the following settings



Copying and Scanning

- 1 Turn the printer and scanner on.
The devices may be turned on in any order.
- 2 Load the printer with paper that supports enlarged copies.
[“Epson Special Media Table” on page 212](#)
- 3 Place the original on the scanner glass or in the auto document feeder (ADF).
[“Placing Documents in the Scanner” on page 84](#)
For information on using the scanner, see the documentation supplied with the device.
- 4 After confirming that the printer is ready, press the ◀/▶ buttons to highlight the  tab and press the OK button.
The enlarged copy dialog box is displayed.
- 5 In the enlarged copy dialog box, press the ▲/▼ buttons to choose the number of copies and press the OK button to start copying.
To change copy settings or the enlargement ratio, press the Menu button. The Enlarged Copy menu is displayed.
The scanner  button can be used in place of the OK button to start copying.
Using the Enlarged Copy settings menu  [“Menu Operations” on page 136](#)
Settings  [“Enlarged Copy menu” on page 173](#)

Note:

If **Other Size** is selected for **Auto** and **A0(2Sheets)** for **Output Size** when the SC-T3200 Series is used, the document will be printed on two sheets as shown.

If the document is printed on an A2 width roll, the two segments can be joined together with tape or the like to create a complete A0 sheet. If the document is printed on a wider roll, the margins will have to be trimmed.

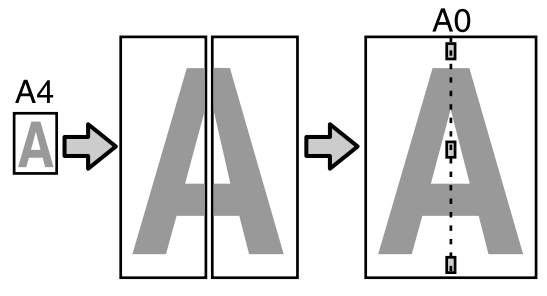

Placing Documents in the Scanner

Failure to observe the following precautions when placing the original in the scanner may result in reduced print quality or scanning failures.

- Be sure to insert the original in landscape (wide) orientation.

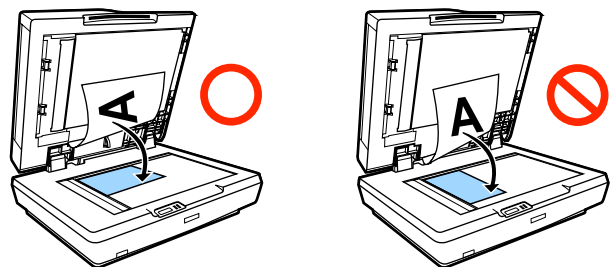

- If there are documents both on the glass and in the ADF, the document in the ADF will be scanned.

Remove documents from the ADF before placing a document on the glass.

- The ADF can not be used when:
 - A4/2->Banner(Auto)** is selected for **Auto**.
 - B1** or **A0** is selected for **Output Size**, and multiple copies were made, or when **A0 (2Sheets)** was selected.

Copying and Scanning

- ❑ The original is 4 x 6 size
- ❑ The original is printed on thick stock (e.g., postcards or photographs)
- ❑ When multiple copies are made from an original placed on the glass, the original may be scanned once for each copy.

Wait until all the copies have been printed before opening the scanner cover.

- ❑ Use the ADF to scan multi-page documents. Because the copies are printed as the originals are scanned, the printer can not collate multiple copies of multi-page documents.

Example: Order in which pages are output when the printer is used to make two copies of a two page document

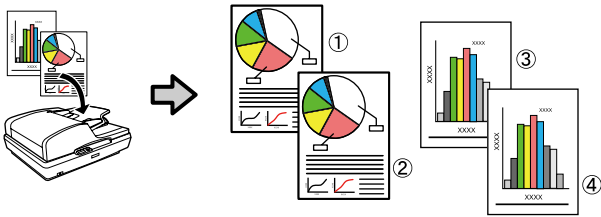

Print From Folder

Print From Folder

Function Summary

You can select a file in a shared folder on the network that has been setup in advance and print it.

Use Remote Manager to configure the shared folder settings.

 [“Preparing to Print From Folder” on page 87](#)

Operation

There are two procedures to select a file and print it. You can use the control panel on the printer or use Remote Manager.

Operating the Control Panel  [“Procedure to Print From Folder” on page 87](#)

See the online help for the procedures to operate Remote Manager.

Supported files

The following files are supported by Print From Folder. The supported files vary depending on whether or not the optional Adobe PostScript 3 expansion unit is installed.

File formats	Not installed	Installed
HP-GL/2	✓	✓
HP RTL	✓	✓
PDF	-	✓
PostScript	-	✓
EPS	-	✓
TIFF	-	✓
JPEG	-	✓
CALS G4(type I)	-	✓

HP-GL/2 and HP RTL format files are printed according to the **HP-GL/2 Settings** in the printer's settings menu.

 [“Printer Setup” on page 154](#)

The other files are printed according to the settings in the **PS3 Expansion Unit** in the printer's settings menu.

 [“Option Setup*4” on page 164](#)

Print From Folder

Preparing to Print From Folder

Use Remote Manager to configure the shared folder settings as shown below.

Remote Manager is included in the software installed in the network interface of the printer.

- 1 Start a web browser on a tablet terminal or computer connected to the printer via the network.
- 2 Enter the IP address specified for the printer in the address bar, and then press the Enter key or the return key.

If any of the following options is installed, proceed to step 3.

- MFP scanner
- Hard disk unit
- Adobe PostScript 3 expansion unit

If they are not installed, proceed to step 4.

- 3 In the screen that is displayed, click Remote Manager.

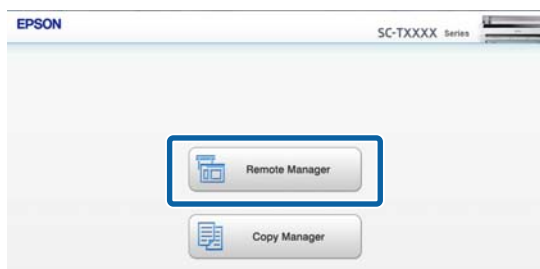

- 4 Open the Setup tab screen, and then click **Shared Folder** in the menu on the left side of the screen.

See the online help for more details on operating Remote Manager.

Procedure to Print From Folder

The procedure to Print From Folder from the operation panel is described below.

Buttons that are used in the following settings

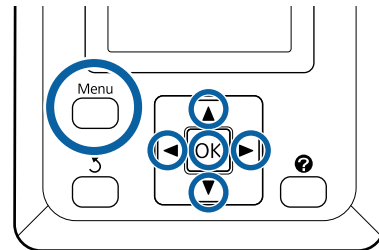

- 1 Confirm that the printer is ready to print. Press the ◀/▶ buttons to select  and press the OK button.

The Print Queues menu is displayed.

- 2 Press the ▼/▲ buttons to select **Print From Folder** and press the OK button.

Only **Print From Folder** is displayed if an optional hard disk unit or Adobe PostScript 3 Expansion Unit is not connected.

A list of the files in the shared folder appears after a short while.

- 3 Press the ▼/▲ buttons to select a file to print and press the OK button.

The print settings screen is displayed.

- 4 Press the ▼/▲ buttons to set the number of copies. Press the OK button to start printing.

If the optional hard disk unit or Adobe PostScript 3 Expansion Unit is not installed, the number of copies is fixed at 1.

To change the paper source, press the Menu button to display the Setting menu. On the SC-T7200D Series/SC-T5200D Series you can select **Roll 1**, **Roll 2**, **Roll Auto**, or **Cut Sheet**.

Print From Folder

The preview screen appears if **Preview** is set to **Yes**. Press the **OK** button in the preview screen to start printing.

To cancel the Preview, press the **⏏** button.

More Ways to Print

More Ways to Print

Enlargements and Horizontal and Vertical Banners

The printer driver can enlarge or reduce documents for different paper sizes. There are three setting methods.

Before printing at non-standard sizes, including vertical or horizontal banners and documents with equal sides, enter the desired paper size in the printer driver.

 [“Printing at Non-Standard Sizes” on page 93](#)

Fit to Roll Paper Width

Automatically enlarges or reduces the image size to fit the roll paper width.

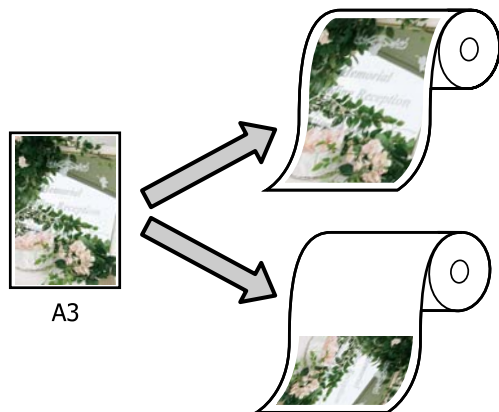

Specify Size

You can specify the enlargement or reduction ratio. Use this method for a non-standard paper size.

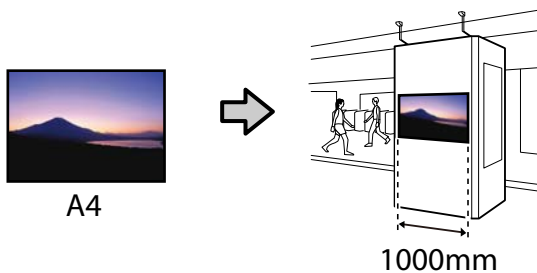

Fit to Output Size

Automatically enlarges or reduces the image size to fit the paper size.

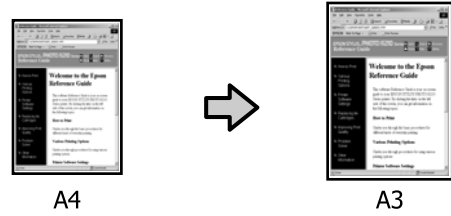

Note:

- When printing from applications designed expressly for horizontal or vertical banners, adjust printer driver settings as described in the application documentation.
- When using Windows applications designed for horizontal or vertical banners, select **Banner** in the **Advanced** tab as required.

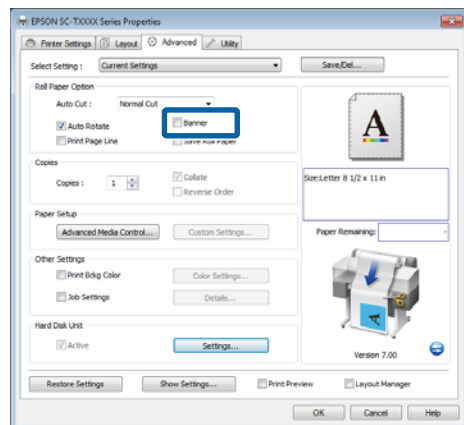

More Ways to Print

Fitting Documents to the Width of the Roll Paper

Making Settings in Windows

1 Display the printer driver's Printer Settings tab and select a **Paper Size** that matches the document page size.

[“Basic Printing Methods\(Windows\)”](#) on page 58

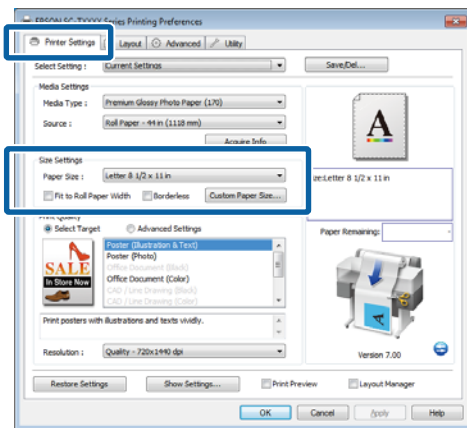

2 In the Layout tab, select **Reduce/Enlarge** and click **Fit to Roll Paper Width**.

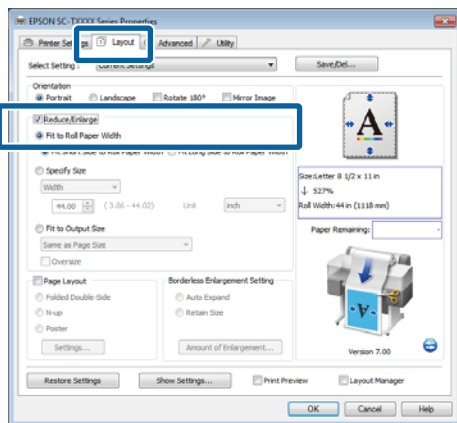

3 Choose whether to fit the short or long edge of the document to the roll paper width.

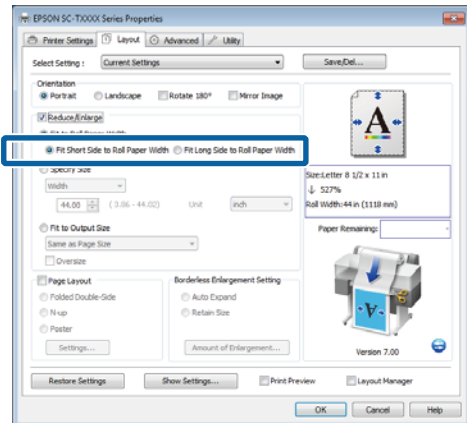

Note:
Output can also be fitted to the roll width by selecting **Fit to Roll Paper Width** in the **Printer Settings** tab.

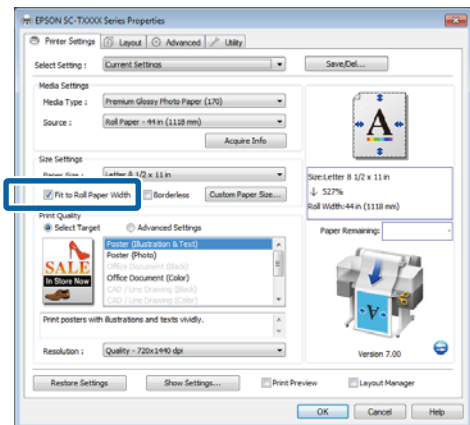

4 Check other settings, and then start printing.

Making Settings for Mac OS X

1 Choose **Page Layout Settings** from the list in the print dialog and select **Reduce/Enlarge**.

[“Basic Printing Methods\(Mac OS X\)”](#) on page 62

More Ways to Print

- 2 Select **Fit to Roll Paper Width** and choose whether to fit the short or long edge of the document to the roll paper width.

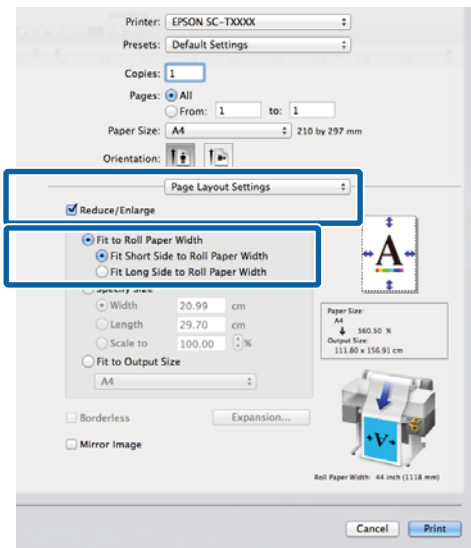

- 3 Check other settings, and then start printing.

Choosing a Print Size

Making Settings in Windows

- 1 Display the printer driver's **Printer Settings** tab and select a **Paper Size** that matches the document page size.

[“Basic Printing Methods\(Windows\)” on page 58](#)

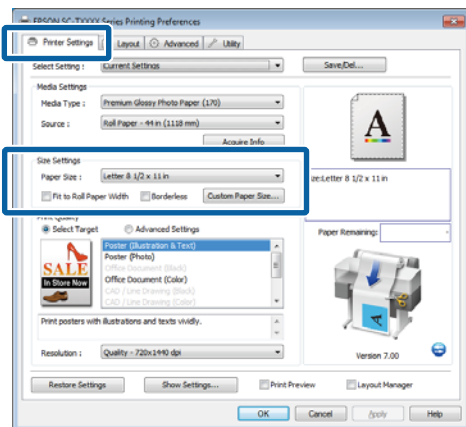

- 2 In the **Layout** tab, select **Reduce/Enlarge** and click **Specify Size**.

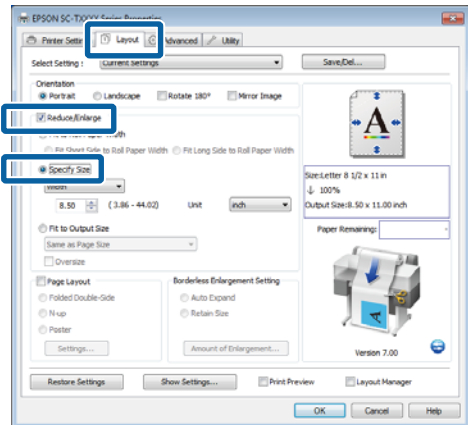

- 3 Choose an input method and select a size.

Enter a value directly or click the arrows to the right of the scale box to set the value.

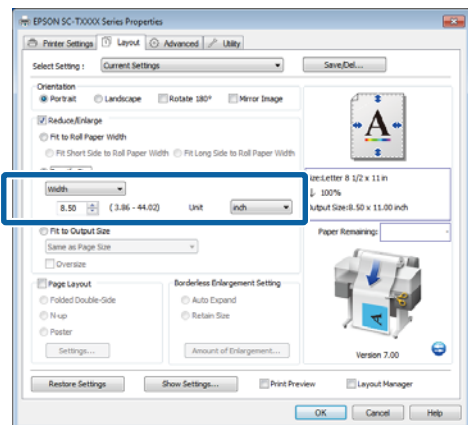

- 4 Check other settings, and then start printing.

Making Settings for Mac OS X

- 1 Choose **Page Layout Settings** from the list in the print dialog and select **Reduce/Enlarge**.

[“Basic Printing Methods\(Mac OS X\)” on page 62](#)

More Ways to Print

- 2 Select **Specify Size**, choose a method for specifying the size, and select a size.

Enter a value directly or click the arrows to the right of the scale box to set the value.

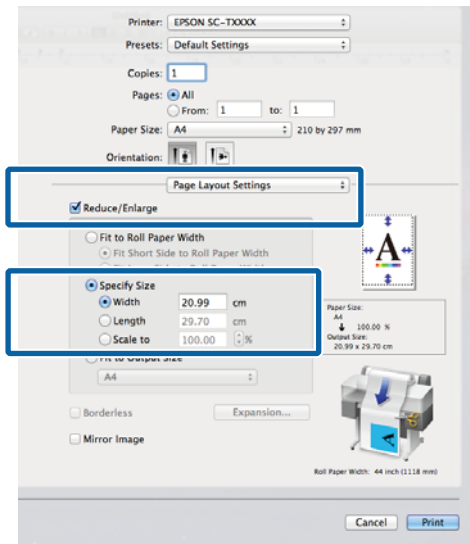

- 3 Check other settings, and then start printing.

Fitting Documents to the Output Size

Making Settings in Windows

- 1 Display the printer driver's Printer Settings tab and select a **Paper Size** that matches the document page size.

☞ “Basic Printing Methods(Windows)” on page 58

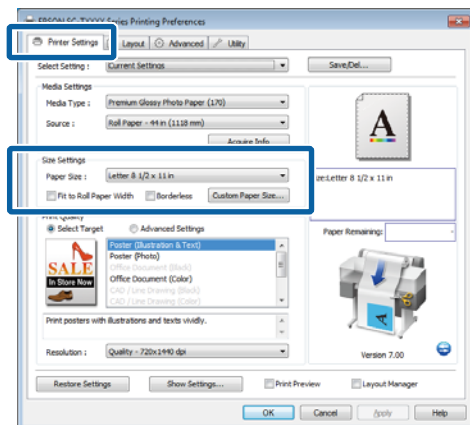

- 2 In the Layout tab, select **Reduce/Enlarge** and click **Fit to Output Size**.

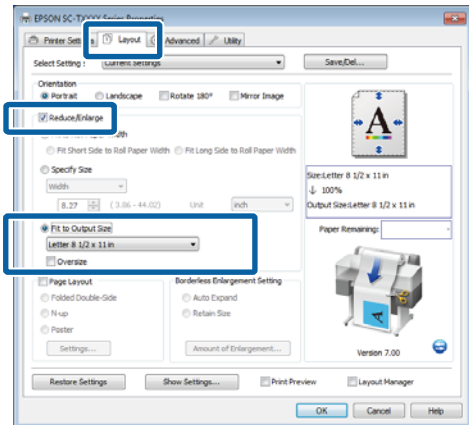

- 3 Select the size of the paper used for printing.

To print the document, margins excluded, at precisely the selected output size, select **Override**.

Note:

When printing using **Override**, load paper that is as large as the selected **Output Size** plus the margins needed by the printer.

Printer margins ☞ “Printable area” on page 65

- 4 Check other settings, and then start printing.

Making Settings for Mac OS X

- 1 Choose **Page Layout Settings** from the list in the print dialog and select **Reduce/Enlarge**.

☞ “Basic Printing Methods(Mac OS X)” on page 62

More Ways to Print

- 2 Select **Fit to Output Size** and choose a paper size that matches the paper in the printer.

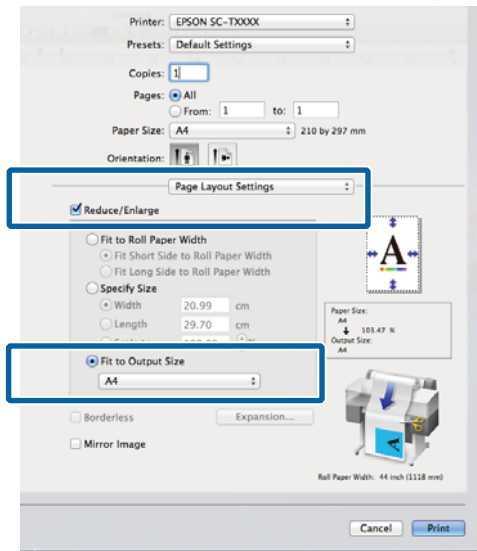

- 3 Check other settings, and then start printing.

Note:
Output can also be fitted to the paper size by selecting **Scale to fit paper size** in the print dialog **Paper Handling** pane.

Printing at Non-Standard Sizes

Before printing at non-standard sizes, including vertical or horizontal banners and documents with equal sides, save the desired paper size in the printer driver. Once they have been saved in the printer driver, custom sizes can be selected in the application **Page Setup** and other print dialogs.

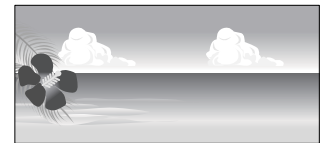

The following sizes can be used.

Paper Width	SC-T7200 Series/ SC-T7200D Series	89 to 1,118 mm
	SC-T5200 Series/ SC-T5200D Series	89 to 914 mm
	SC-T3200 Series	89 to 620 mm*1
Length*2	Windows: 127 to 15,000 mm Mac OS X: 127 to 15,240 mm	

*1.The maximum printable width is 610 mm.

*2.The paper length can be longer if using applications that support banner printing. However, the actual print size depends on the application, the paper size loaded in the printer, and the computer environment.



Important:

- ❑ The smallest size supported by the printer is 254 mm wide × 127 mm long. If a smaller size is entered in the printer driver as a **Custom Paper Size**, the document will print with wider-than-expected margins, which must be trimmed.
- ❑ For Mac OS X Custom Paper Sizes, although you can specify a large paper size which cannot be loaded on this printer, it will not be printed properly.
- ❑ The available output size is limited depending on the application.

More Ways to Print

Making Settings in Windows

- 1 Display the printer driver's Printer Settings tab and click the **Custom Paper Size**.

[“Basic Printing Methods\(Windows\)” on page 58](#)

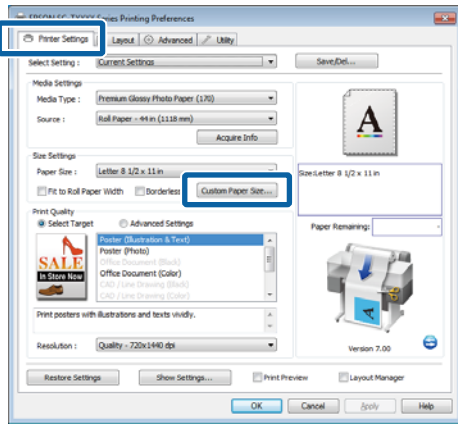

Important:
Custom Paper Size is not available when Front - Poster Board is selected for Source.

- 2 Enter the desired size in the User Defined Paper Size dialog and click **Save**.

- You can enter up to 24 single-byte characters for the **Paper Size Name**.
- To view **Paper Width** and **Paper Height** values for a standard size close to the desired custom size, select the appropriate option for **Base Paper Size**.
- If you specify the desired **Fix Aspect Ratio** and select **Landscape** or **Portrait** for **Base**, you need only enter either the **Paper Width** or **Paper Height**.

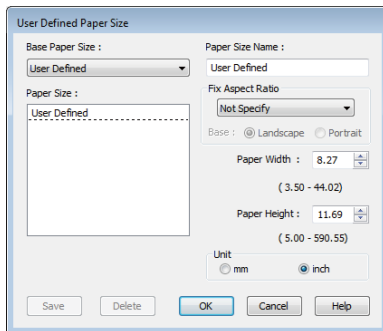

Note:

- To change the paper size you saved, select the paper size name from the list on the left.
- To delete the user-defined size you saved, select the paper size name from the list on the left, and then click **Delete**.
- You can save up to 100 paper sizes.

- 3 Click **OK**.

The saved sizes are now available in the **Paper Size** menu of the Printer Settings tab.

You can now print as normal.

Making Settings for Mac OS X

- 1 When the Print screen is displayed, select **Manage Custom Sizes** from the **Paper Size** list.

[“Basic Printing Methods\(Mac OS X\)” on page 62](#)

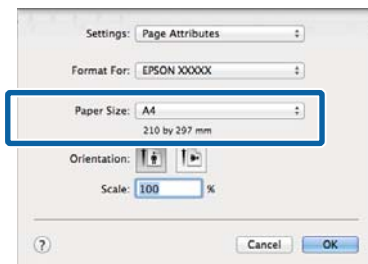

Note:

If page setting options are not available in the application's print dialog, display the page settings dialog.

- 2 Click **+**, and then enter the paper size name.

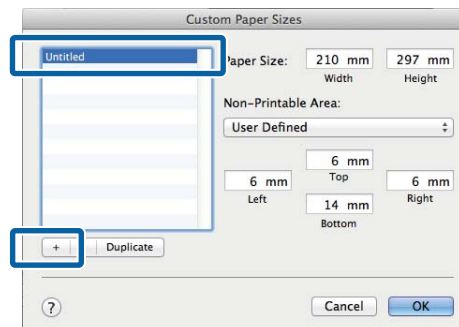

More Ways to Print

- Enter the **Width, Height** for the **Paper Size**, enter the margins, and then click **OK**.

The range of values available for page sizes and margins vary with the printer model and the values selected with the printer.

“Printable area” on page 65

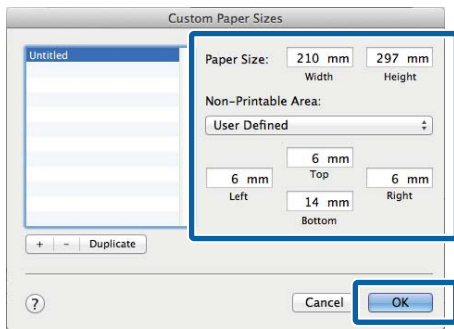

Note:

- To edit a saved custom size, choose its name from the list on the left.
- To copy a saved custom size, select the size in the list on the left and click **Duplicate**.
- To delete a saved custom size, select it in the list on the left and click **-**.
- The custom paper size setting differs depending on the operating system version. See your operating system's documentation for details.

- Click **OK**.

You can select the paper size you saved from the Paper Size pop-up menu.

You can now print as normal.

Printing CAD Drawings

The printer supports the HP-GL/2 driver and HP RTL (Raster Transfer Language) used in plotters. You can use one of the following methods to print CAD drawings with this printer.

- Print in the CAD / Line Drawing mode of the included printer driver.
- Print while emulating HP-GL/2 and HP RTL, which are used in plotters.

Whether the printer prints normally or prints while emulating HP-GL/2 and HP RTL is determined and selected automatically by the print data sent. If operation mode switching and printing are not performed correctly, open the Setup menu and set **Printer Mode** to **HP-GL/2**.

Printing in the CAD / Line Drawing mode of the printer driver

When you will print a CAD drawing with Windows applications software, we recommend printing in the CAD / Line Drawing mode of the printer driver.

Windows

- Open the Printer Settings tab of the printer driver. Set **Print Quality** to **Select Target**, and then select **CAD / Line Drawing (Black)**, **CAD / Line Drawing (Color)** or **CAD / Line Drawing (Bi-Level)**.

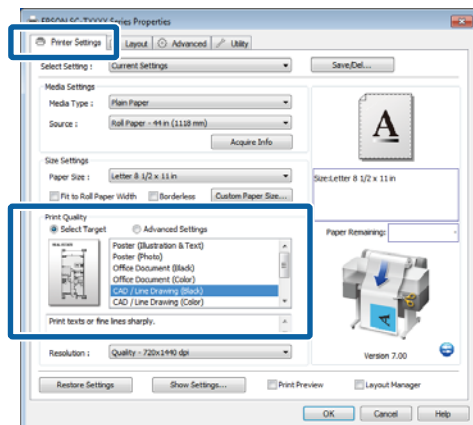

More Ways to Print

Note:
 The **CAD / Line Drawing (Black)**, **CAD / Line Drawing (Color)**, and **CAD / Line Drawing (Bi-Level)** options are available for **Select Target** when a paper type suited to printing CAD drawings is selected.

2 Check other settings, and then start printing.

Mac OS X

1 Display the print dialog and select **Printer Settings** from the list.

[“Basic Printing Methods\(Mac OS X\)” on page 62](#)

2 Set **Mode** to **Select Target**, and then select **CAD / Line Drawing (Black)**, **CAD / Line Drawing (Color)**, or **CAD / Line Drawing (Bi-Level)**.

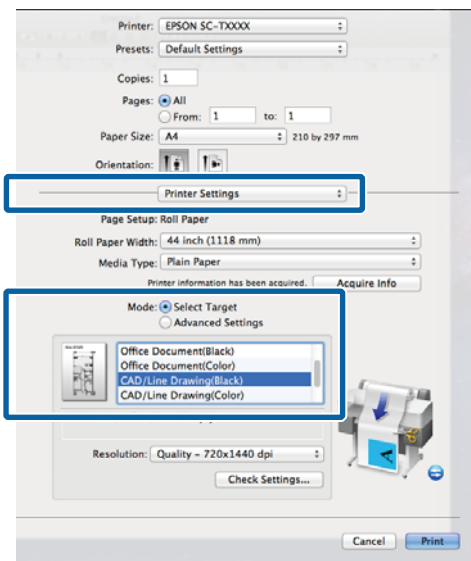

Note:
 The **CAD / Line Drawing (Black)** and **CAD / Line Drawing (Color)** options are available for **Select Target** when a paper type suited to printing CAD drawings is selected.

3 Check other settings, and then start printing.

Printing while Emulating HP-GL/2 and HP RTL

The printer can emulate* HP-GL/2 (compatible with HP Designjet 750C) and HP RTL.

When you want to print with applications using HP-GL/2 or HP RTL output, configure the output equipment as shown below according to your model.

SC-T7200 Series/SC-T7200D Series/SC-T5200 Series/SC-T5200D Series

HP Designjet 750C C3195A

SC-T3200 Series

HP Designjet 750C C3196A

* Not all functions are supported. If you will use an untested application, test its output in advance.

For a list of applications that have been tested, visit the Epson website at <https://www.epson.com>.



Important:

The printer may not perform as expected if the volume of the data to be printed is extremely large.

When you will print while emulating HP-GL/2 and HP RTL, observe the following points.

Select Paper Type setting

Set one of the following options for the **Select Paper Type** setting of the printer. If other paper types are used, print quality may be reduced.

Singleweight Matte/Plain Paper/Tracing Paper/Tracing Paper <Low Duty>

HP-GL/2 Settings

When you will print while emulating HP-GL/2 and HP RTL, set the Print Settings as follows: On the printer, select Setup menu > **Printer Setup** > **HP-GL/2 Settings**.

[“Setup menu” on page 154](#)

More Ways to Print

Switching Roll Paper Automatically before Printing (SC-T7200D Series/SC-T5200D Series Only)

Explanations in this section use a typical method to switch automatically to the appropriate roll paper for the print job.

Switching to Roll 1/Roll 2 by Paper Type

For example, when you use the following method often, if you use the settings described below, the printer can switch between Roll 1 and Roll 2 automatically in accordance with the paper type.

Usage example

You use different types of paper depending on the purpose of its use. For example you print to plain paper for drawings for in-house checks and print to color print paper for presentations and drawings for clients.

In this example, the paper is loaded as follows. All paper has the same width.

Roll 1: Plain Paper

Roll 2: Singleweight Matte Paper

Settings on Windows

1 Using the control panel of the printer, confirm **Type Match** is set in Setup menu > **Printer Setup** > **Roll Paper Setup** > **Roll Switch Condition** > **Paper Type**.

The default **Paper Type** setting is **Type Match**. If the setting has not been changed, the setting is **Type Match**.

["Setup menu" on page 154](#)

2 Open the Printer Settings tab of the printer driver and confirm that **Source** is **Roll Auto - XXXXX**.

XXXXX indicates the width of the roll paper currently in use.

If the setting is not **Roll Auto - XXXXX**, click it and select **Roll Auto - XXXXX**.

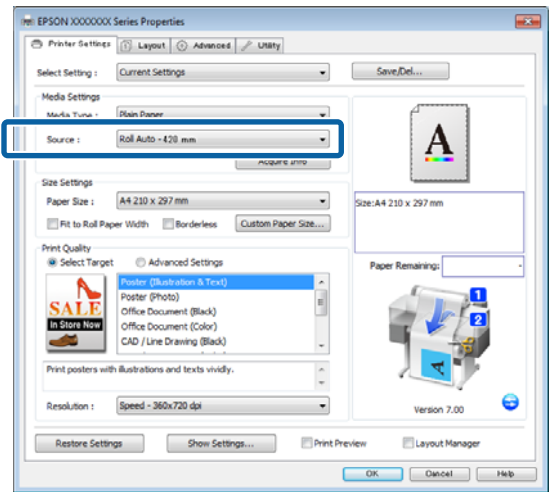

3 For **Media Type**, select the paper type you want to use for printing.

In this example, **Plain Paper** or **Singleweight Matte Paper** is selected depending on the purpose of its use.

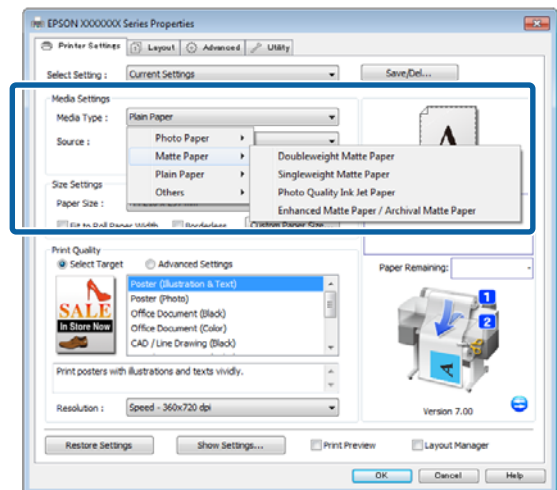

4 Set **Paper Size**, **Print Quality**, and other necessary settings, and then print.

If the message "The Media Type differs to the setting on the printer.", appears, click **Ignore**.

More Ways to Print

Making Settings for Mac OS X

- Using the control panel of the printer, confirm **Type Match** is set in Setup menu > **Printer Setup** > **Roll Paper Setup** > **Roll Switch Condition** > **Paper Type**.

The default **Paper Type** setting is **Type Match**. If the setting has not been changed, the setting is **Type Match**.

 "Setup menu" on page 154

- On the computer, open the Print screen, confirm that **Paper Size** is Roll Paper, and then select **Printer Settings** from the list.

- Check that the **Roll Switch** is **Auto**.

If the setting is not **Auto**, click it and select **Auto**.

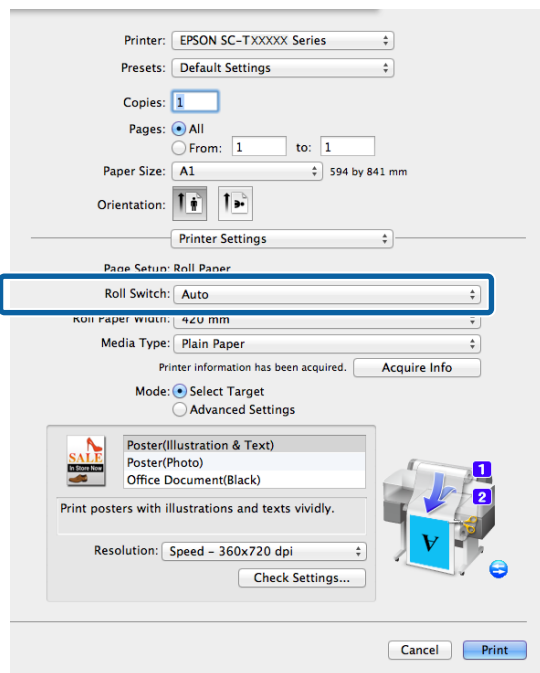

- For **Media Type**, select the paper type you want to use for printing.

In this example, **Plain Paper** or **Singleweight Matte Paper** is selected depending on the purpose of its use.

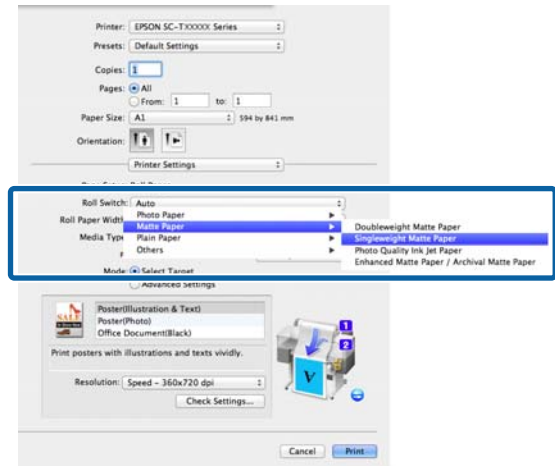

- Set **Print Quality** and other necessary settings, and then print.

If the message "The Media Type differs to the setting on the printer.", appears, click **Ignore**.

Switching to Roll 1/Roll 2 by Document Size

For example, when you use the following method often, if you use the settings described below, the printer can switch between Roll 1 and Roll 2 automatically in accordance with the document size of the print job.

Usage example

You want to switch automatically to the roll paper with the smaller margin automatically when printing drawings of various sizes including A0, A1, A2, and A3.

In this example, the paper is loaded as follows. The paper type is the same.

Roll 1: A2 width

Roll 2: A0 width

More Ways to Print

Settings on Windows

- Using the control panel of the printer, confirm **Best Fit** is set in Setup menu > **Printer Setup** > **Roll Paper Setup** > **Roll Switch Condition** > **Paper Width**.

The default **Paper Width** setting is **Best Fit**. If the setting has not been changed, the setting is **Best Fit**.

 [“Setup menu” on page 154](#)

- Open the Printer Settings tab of the printer driver and confirm that **Source** is **Roll Auto - XXXXX**.

XXXXX indicates the width of the roll paper currently in use.

If the setting is not **Roll Auto - XXXXX**, click it and select **Roll Auto - XXXXX**.

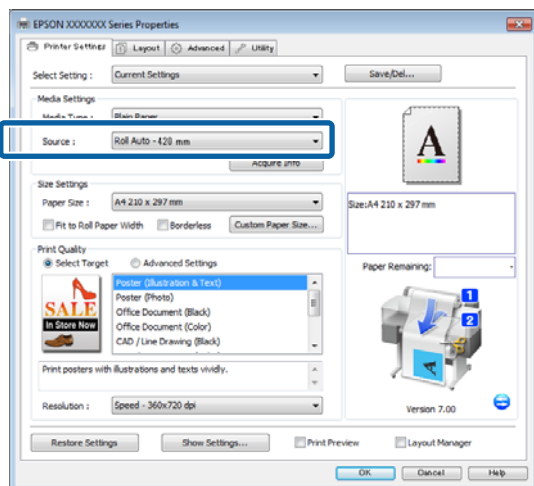

- For **Paper Size**, select the Paper Size set in the application.

In this example, select **A1 594 x 841 mm**.

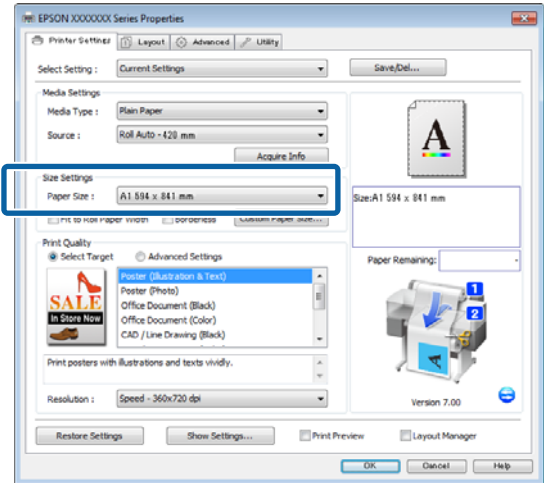

- Set **Print Quality** and other necessary settings, and then print.

The printer prints to the roll paper of Roll 2 (A0 Width).

If **A3** or **A2** is selected in Step 3, the printer prints to the roll paper of Roll 1 (A2 Width).

Making Settings for Mac OS X

- Using the control panel of the printer, confirm **Best Fit** is set in Setup menu > **Printer Setup** > **Roll Paper Setup** > **Roll Switch Condition** > **Paper Width**.

The default **Paper Width** setting is **Best Fit**. If the setting has not been changed, the setting is **Best Fit**.

 [“Setup menu” on page 154](#)

- On the computer, open the Print screen, confirm that **Paper size** is **Roll Paper**.

In this example, select **A1**.

More Ways to Print

- 3 Check that the **Roll Switch** is **Auto**.
If the setting is not **Auto**, click it and select **Auto**.

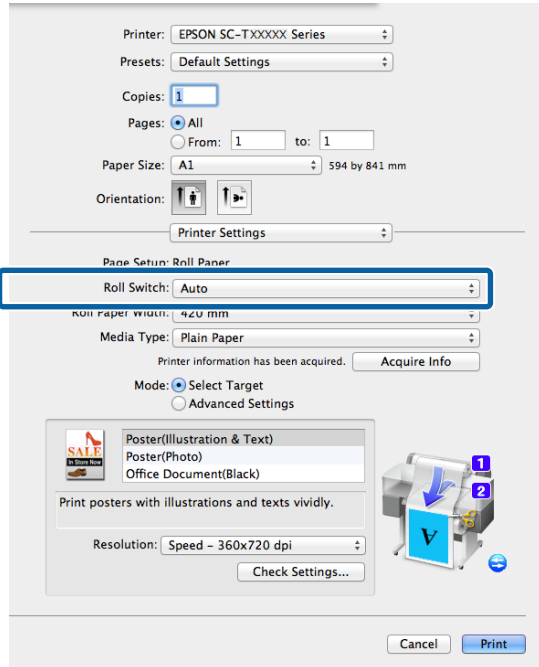

- 4 Set **Print Quality** and other necessary settings, and then print.

The printer prints to the roll paper of Roll 2 (A0 Width).

If A3 or A2 is selected in Step 2, the printer prints to the roll paper of Roll 1 (A2 Width).

Switching to the Roll with the Most Paper Remaining (Roll 1/ Roll 2) before Printing if the Paper Runs Out

For example, when you use the following method often, if you use the settings described below, the printer switches between Roll 1 and Roll 2 automatically to print using the roll paper with the most paper remaining.

Usage example

You want to predict whether the roll paper remaining is less than the print job during continuous unattended operation of a large print job, switch to the other roll paper automatically, and continue printing without stopping.

In this example, the paper is loaded as follows.

Roll 1: Plain Paper A1 Width

Roll 2: Plain Paper A1 Width

Settings on Windows

- 1 Use the control panel of the printer to open the Paper menu and set **Roll Paper Remaining** to **On**, and then set the Roll Paper length loaded into both Roll 1 and Roll 2.

When you set the roll paper, if roll paper length has been set or a barcode with roll data is printed on the current roll, proceed to Step 2.

[“Paper menu” on page 149](#)

- 2 Using the control panel of the printer, confirm **Print Length** is set in Setup menu > **Printer Setup** > **Roll Paper Setup** > **Roll Switch Condition** > **Paper Length**.

The default **Paper Length** setting is **Print Length**. If the setting has not been changed, the setting is **Print Length**.

[“Setup menu” on page 154](#)

- 3 Open the Printer Settings tab of the printer driver and confirm that **Source** is **Roll Auto - XXXXX**.

XXXXX indicates the width of the roll paper currently in use.

If the setting is not **Roll Auto - XXXXX**, click it and select **Roll Auto - XXXXX**.

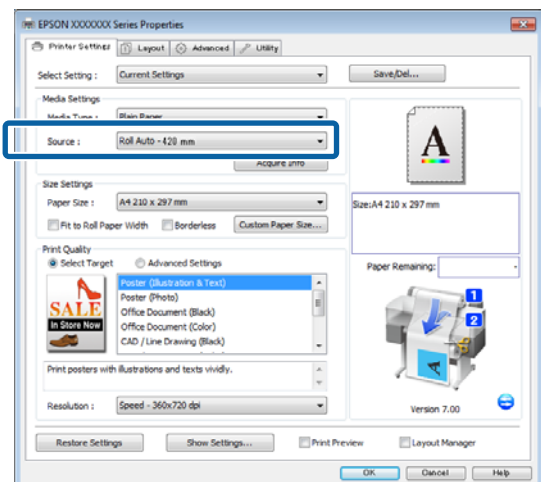

More Ways to Print

- 4** Set **Paper Size**, **Print Quality**, and other necessary settings, and then print.

If the printer predicts that the roll paper remaining is shorter than the print length during printing, it switches to the roll paper that is longer than the print length automatically and continues printing.

Making Settings for Mac OS X

- 1** Use the control panel of the printer to open the Paper menu and set **Roll Paper Remaining** to **On**, and then set the Roll Paper length loaded into both Roll 1 and Roll 2.

When you set the roll paper, if roll paper length has been set or a barcode with roll data is printed on the current roll, proceed to Step 2.

 [“Paper menu” on page 149](#)

- 2** Using the control panel of the printer, confirm **Print Length** is set in Setup menu > **Printer Setup** > **Roll Paper Setup** > **Roll Switch Condition** > **Paper Length**.

The default **Paper Length** setting is **Print Length**. If the setting has not been changed, the setting is **Print Length**.

 [“Setup menu” on page 154](#)

- 3** On the computer, open the Print screen, confirm that **Paper Size** is Roll Paper, and then select **Printer Settings** from the list.

- 4** Check that the **Roll Switch** is **Auto**.

If the setting is not **Auto**, click it and select **Auto**.

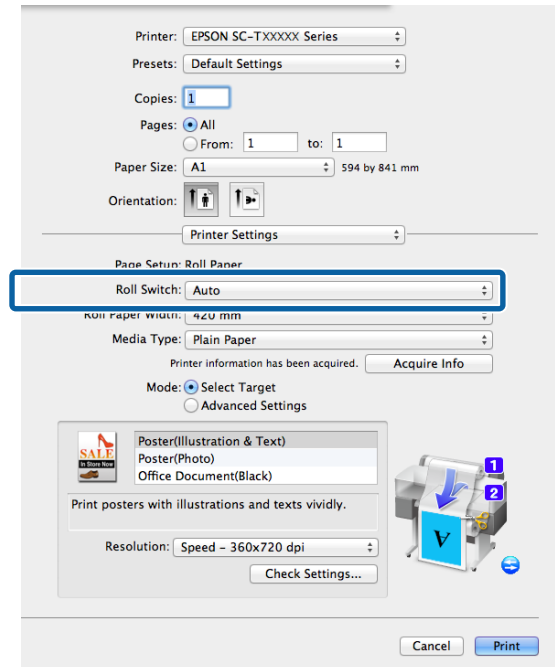

- 5** Set **Print Quality** and other necessary settings, and then print.

If the printer predicts that the roll paper remaining is shorter than the print length during printing, it switches to the roll paper that is longer than the print length automatically and continues printing.

More Ways to Print

Borderless Printing

You can print your data without margins on the paper.

The types of borderless printing you can choose vary as shown below depending on the media type.

Roll Paper: No margins for all edges, no margins for the left and right

Cut Sheets: No margins for the left and right only

(Borderless printing is not available with poster board.)

When printing borderless for all edges, you can also configure the cutting operation. [☞ “About Roll Paper Cutting” on page 104](#)

When performing left and right borderless printing, margins appear on the top and bottom of the paper.

Top and bottom margin values [☞ “Printable area” on page 65](#)

Types of Borderless Printing Methods

You can perform borderless printing using the following two methods.

Auto Expand

The printer driver enlarges the print data to a size slightly larger than the paper size and prints the enlarged image. The sections which are beyond the paper edges are not printed; therefore, resulting in borderless printing.

Use settings such as Page Setup in the applications to set the size of the image data as follows.

- Match the paper size and page setting for the print data.
- If the application has margin settings, set the margins to 0 mm.
- Make the image data as large as the paper size.

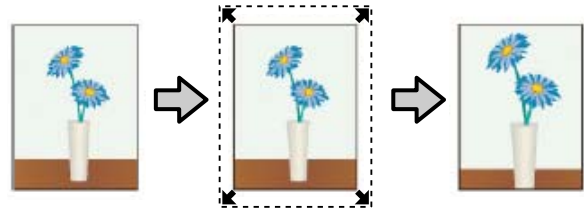

Retain Size

Create the print data larger than the paper size in the applications to produce borderless output. The printer driver does not enlarge the image data. Use settings such as Page Setup in the applications to set the size of the image data as follows.

- Create print data larger than its actual print size by 3 mm on the left and right (6 mm in total).
- If the application has margin settings, set the margins to 0 mm.
- Make the image data as large as the paper size.

Select this setting if you want to avoid image enlargement by the printer driver.

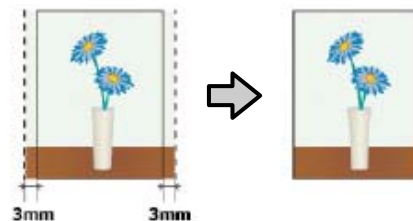

Supported Media Sizes for Borderless Printing

The following media sizes are supported for borderless printing.

The sizes supported vary with the printer model.

Supported paper widths	SC-T7200 Series/ SC-T7200 D Series	SC-T5200 Series/ SC-T5200 D Series	SC-T3200 Series
10 inch	✓	✓	✓
30 cm	✓	✓	✓
Super A3/ 329 mm/ 13 inch	✓	✓	✓

More Ways to Print

Supported paper widths	SC-T7200 Series/ SC-T7200 D Series	SC-T5200 Series/ SC-T5200 D Series	SC-T3200 Series
16 inch	✓	✓	✓
US C/17 inch	✓	✓	✓
B2/515 mm	✓	✓	✓
A1/594mm	✓	✓	✓
24 inch	✓	✓	✓
B1/728 mm	✓	✓	–
A0/841 mm	✓	✓	–
36 inch	✓	✓	–
B0/1030 mm	✓	–	–
44 inch	✓	–	–

Depending on the media type, the print quality may decline or borderless printing cannot be selected.

 [“Epson Special Media Table” on page 212](#)

More Ways to Print

About Roll Paper Cutting

When performing borderless printing on roll paper, you can specify whether it is left and right borderless printing or all edges borderless printing, and how to cut the paper in the printer driver's **Roll Paper Option**. The cutting operation for each value is shown in the following chart.

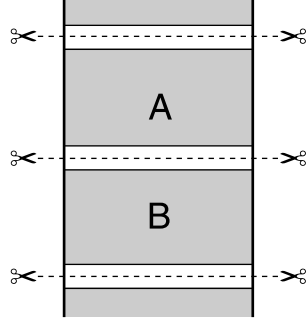
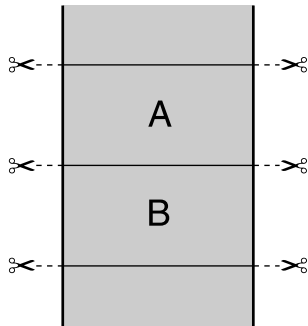
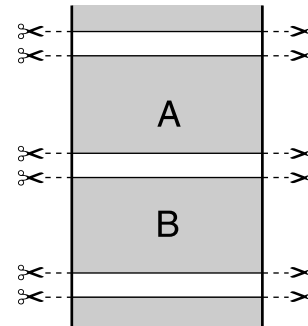
Printer driver settings	Borderless	Single Cut	Double Cut
Cutting Operation			
Explanation	<p>The default printer driver setting is Borderless.</p>	<ul style="list-style-type: none"> ❑ The top area may become slightly uneven depending on the image since the print operation stops while cutting the top edge of the roll paper. ❑ If the cut position is misaligned slightly, small parts of the image may be shown on the top or bottom of the adjacent pages. If this occurs, perform Adjust Cut Position. 👉 "Maintenance menu" on page 153 ❑ When you print one page only or print one page multiple times, the operation is the same as that for Double Cut. When continuously printing multiple sheets, the printer cuts 1 mm inside on the top edge of the first page and the bottom edge of the subsequent pages to avoid showing margins. 	<ul style="list-style-type: none"> ❑ The top area may become slightly uneven depending on the image since the print operation stops while cutting the top edge of the roll paper. ❑ The printed paper is approximately 2 mm shorter than the specified size since the printer cuts the paper inside the image to avoid showing top and bottom margins. ❑ After cutting the bottom edge of the previous page, the printer feeds the paper, and then cuts the top edge of the following page. Although this produces 60 to 127 mm cut-off pieces, the cut is more accurate. ❑ If whitespace appears above the top edge, perform Adjust Cut Position. 👉 "Maintenance menu" on page 153

More Ways to Print

Setting Procedures for Printing

Making Settings in Windows

1 Display the printer driver's Printer Settings tab and adjust the following settings.

☞ “Basic Printing Methods(Windows)” on page 58

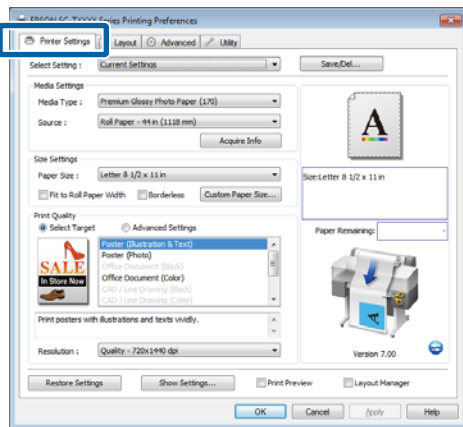

2 Select **Borderless** in the **Size Settings** area.

To fit output to the roll width, choose **Fit to Roll Paper Width** before selecting **Borderless**.

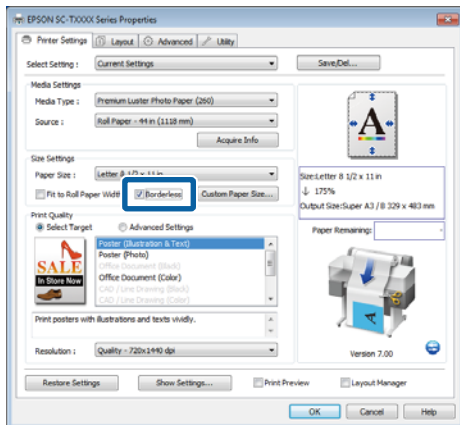

3 In the **Layout** tab **Borderless Enlargement Setting** area, select either **Auto Expand** or **Retain Size**.

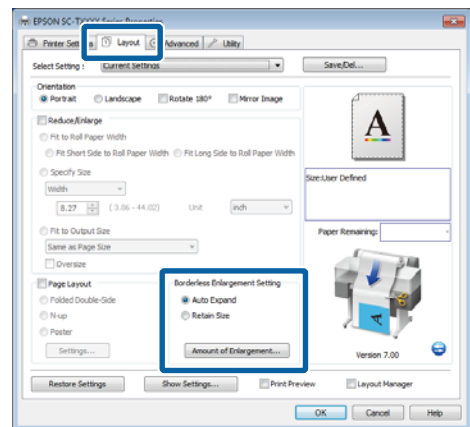

If **Auto Expand** is selected, click **Amount of Enlargement** and choose the amount cut off at the edges.

Note:
*Retain Size is not available when **Fit to Roll Paper Width** is selected in the **Printer Settings** tab or **Reduce/Enlarge** is selected in the **Layout** tab.*

Max : 3 mm for left and 5 mm for right
 (the image shifts 1 mm to the right)

Standard : 3 mm for left and right

Min : 1.5 mm for left and right

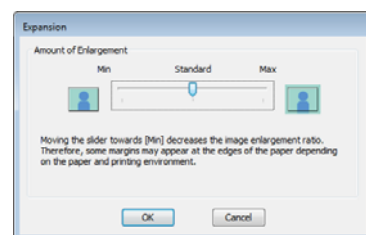

Note:
*Moving the slider towards **Min** decreases the image enlargement ratio. Therefore, some margins may appear at the edges of the paper depending on the paper and printing environment.*

More Ways to Print

4 When roll paper is used, **Auto Cut** options are available in the Advanced tab **Roll Paper Option** area.

[“About Roll Paper Cutting” on page 104](#)

5 Check other settings, and then start printing.

Making Settings for Mac OS X

1 Open the Print screen and select the paper size from the **Paper Size** option, and then select a borderless printing method.

[“Basic Printing Methods\(Mac OS X\)” on page 62](#)

The selections for borderless printing methods are displayed as shown below.

XXXX (Roll Paper - Borderless (Auto Expand))

XXXX (Roll Paper - Borderless (Retain Size))

XXXX (Sheet - Borderless (Auto Expand))

XXXX (Sheet - Borderless (Retain Size))

Where XXXX is the actual paper size, such as A4.

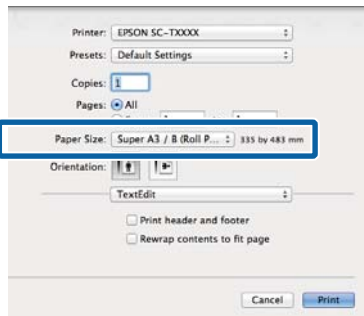

Note:

If page setting options are not available in the application's print dialog, display the page settings dialog.

2 If **Auto Expand** is selected for paper size, select **Page Layout Settings** from the list and click **Expansion**.

The following section shows how much the image will be larger than the paper edges.

Max : 3 mm for left and 5 mm for right
(the image shifts 1 mm to the right)

Normal : 3 mm for left and right

Min : 1.5mm for left and right



Note:

*Moving the slider towards **Min** decreases the image enlargement ratio. Therefore, some margins may appear at the edges of the paper depending on the paper and printing environment.*

3 When using roll paper, select **Advanced** from the list and choose an **Auto Cut** option.

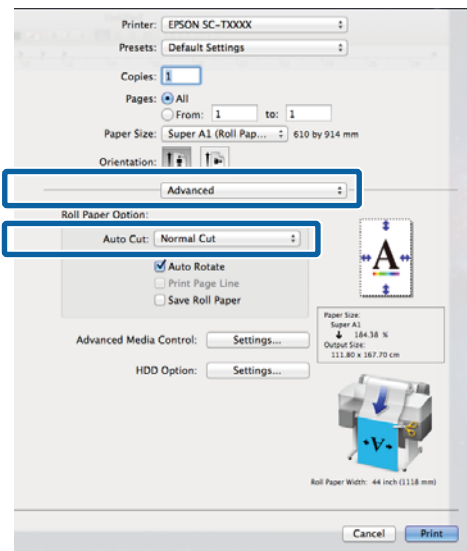

[“About Roll Paper Cutting” on page 104](#)

4 Check other settings, and then start printing.

More Ways to Print

Correct color and print

The printer driver automatically and internally corrects colors to match the color space. You can select from the following color correction modes.

- EPSON Standard (sRGB)

Optimizes the sRGB space and corrects the color.
- Business Graphics

Performs color correction to sharpen your images based on the sRGB space.
- Line Drawing

Optimizes color correction for line drawing by processing the border between lines and the background as discontinuous.
- ICM

Performs color management to match the colors in the image data to those in the printed output (Windows only).

 [“Color Management Printing” on page 120](#)
- Off (No Color Management)

Color correction is not performed by the printer driver. Choose if color management is performed by the application.

 [“Color Management Printing” on page 120](#)

If **EPSON Standard (sRGB)/Business Graphics/Line Drawing** is selected for **Color Mode**, a **Settings** button will be displayed.

Click the **Settings** button to adjust Gamma, Brightness, Contrast, Saturation, and color balance.

Use this option when the application in use does not have a color correction function.

Note:

The color correction options available vary with the operating system and the type of paper used.

Making Settings in Windows

1

When using applications featuring a color management function, specify how to adjust colors from these applications.

When using applications without a color management function, start from Step 2.

Depending on the type of the application, make the settings following the table below.

Adobe Photoshop CS3 or later
 Adobe Photoshop Elements 6 or later
 Adobe Photoshop Lightroom 1 or later

OS	Color Management Settings
Windows 10, Windows 8.1, Windows 8, Windows 7, Windows Vista	Printer Manages Colors
Windows XP (Service Pack 2 or later and .NET 3.0 or later)	
Windows XP (other than the above)	No Color Management

In other applications, set **No Color Management**.

Note:

For information on supported platforms, see the website for the application in question.

Example of Adobe Photoshop CS5

Open the Print screen.

More Ways to Print

Select **Color Management** and then select **Document**. Select **Printer Manages Colors** as the **Color Handling** setting, and then click **Print**.

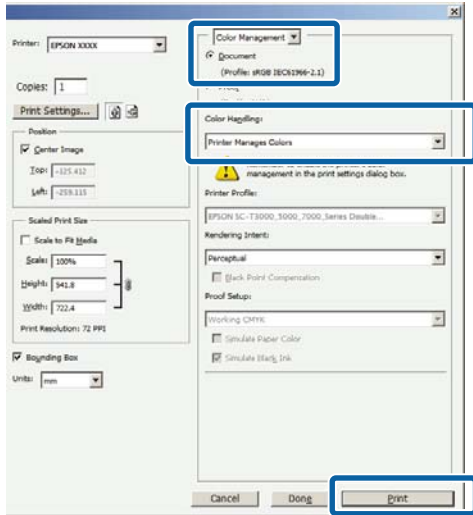

2 In the printer driver's Printer Settings tab, select **Advanced Settings** for **Print Quality** and choose a color correction option.

➤ “Basic Printing Methods(Windows)” on page 58

Additional adjustments can be made by clicking **Settings**.

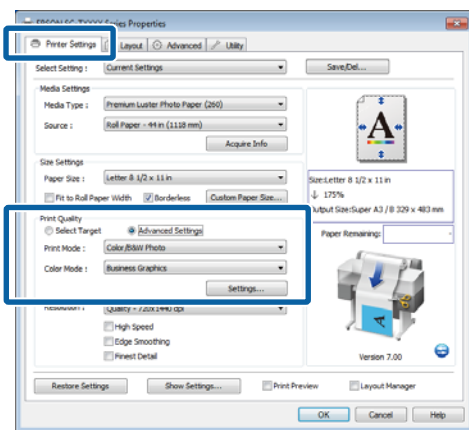

3 Clicking the **Settings** button allows you to adjust **Gamma, Brightness, Contrast, Saturation, color balance**, and other settings.

See the printer driver help for more details on each item.

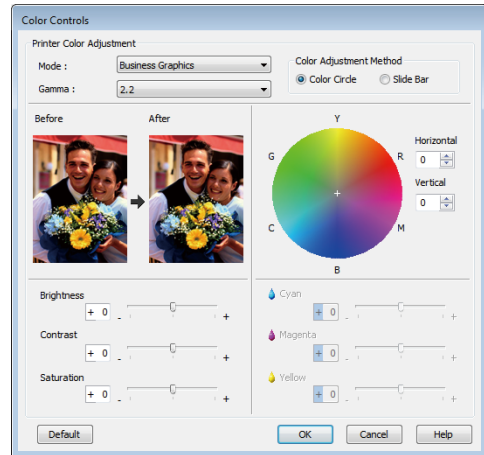

Note:
You can adjust the correction value by checking the sample image on the left side of the screen. Color balance can also be adjusted by selecting **Color Circle** or **Slide Bar** for **Color Adjustment Method**.

4 Check other settings, and then start printing.

Making Settings for Mac OS X

1 When using applications featuring a color management function, specify how to adjust colors from these applications.

When using applications without a color management function, start from Step 2.

When using the following applications, select the **Printer Manages Colors** color management option.

- Adobe Photoshop CS3 or later
- Adobe Photoshop Elements 6 or later
- Adobe Photoshop Lightroom 1 or later

In other applications, set **No Color Management**.

More Ways to Print

Note:

For information on supported platforms, see the website for the application in question.

Example of Adobe Photoshop CS5

Open the Print screen.

Select **Color Management** and then select **Document**. Select **Printer Manages Colors** as the **Color Handling** setting, and then click **Print**.

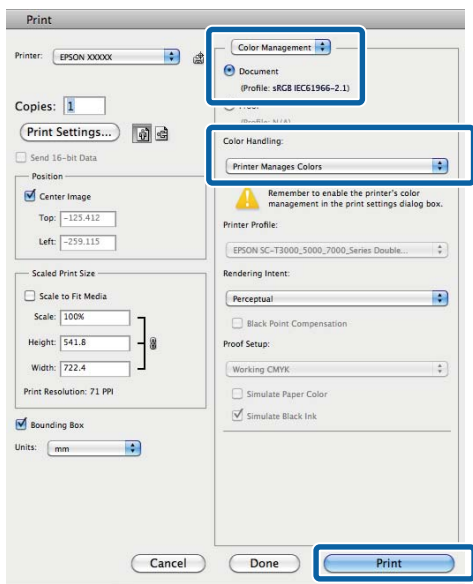

2 Display the Print screen.

📖 “Basic Printing Methods(Mac OS X)” on page 62

3 Select **Color Matching** from the list, and then click **EPSON Color Controls**.

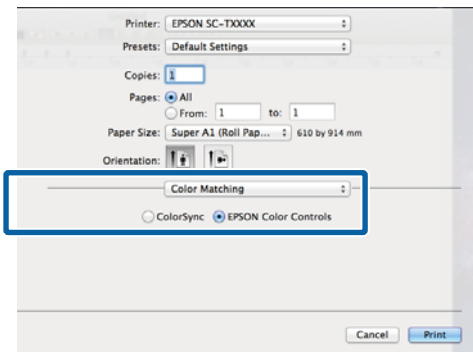

Note:

EPSON Color Controls will not be available in the following applications if Step 1 is omitted.

- Adobe Photoshop CS3 or later
- Adobe Photoshop Lightroom 1 or later
- Adobe Photoshop Elements 6 or later

4 Choose **Printer Settings** from the list and select **Advanced Settings** for **Mode**.

5 Choose a color correction option from the **Color Mode** list.

Additional adjustments can be made by clicking **Settings**.

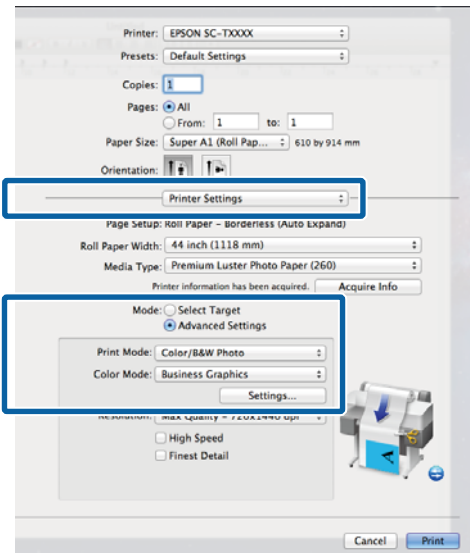

Note:

When using the following applications with Mac OS X 10.5, clear the **Use Generic RGB** checkbox.

- Adobe Photoshop CS3 or later
- Adobe Photoshop Lightroom 1 or later
- Adobe Photoshop Elements 6 or later

Select the check box when using a different application from those listed above.

More Ways to Print

- 6** Make the necessary settings.
See the printer driver help for more details on each item.



- 7** Check other settings, and then start printing.

Multi-Page/Poster Printing

You can print multiple pages on a single sheet or a single page across multiple sheets.

The following three multi-page/poster printing methods are available.

- **Folded Double-Side (Windows only)**
Two consecutive pages are printed on a single sheet. The second page is flipped 180° and printed adjacent to the first page, allowing the paper to be folded to make a double-sided document.

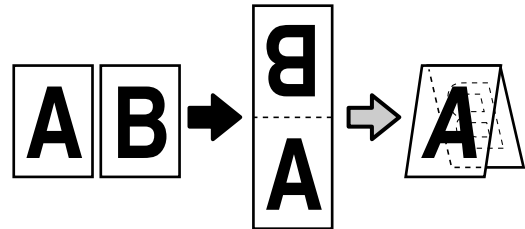

- **N-up**
Two or four consecutive pages can be printed on a single sheet.

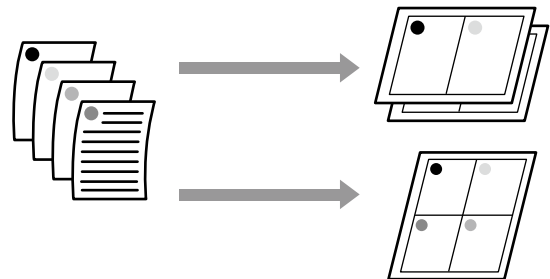

More Ways to Print

• **Poster (Windows only)**

A single page can be printed across multiple sheets. The sheets can then be joined together to form large posters (up to 16 times the original size). If **Borderless Poster Print** is selected, the sheets can be joined without trimming the edges, but because the portions outside the edges of the paper will be lost, the joins may be imperfect.

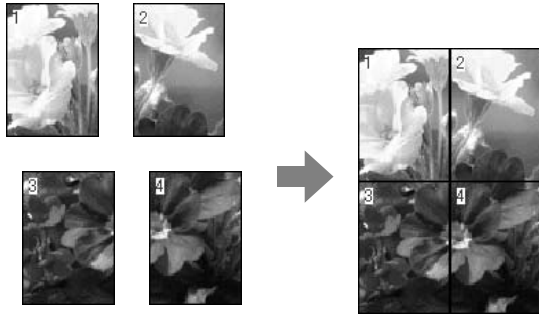

Folded Double-Side (Windows only)

1 In the printer driver's Layout tab, select **Page Layout**. Next, select **Folded Double-Side** and click the **Settings** button.

[“Basic Printing Methods\(Windows\)” on page 58](#)

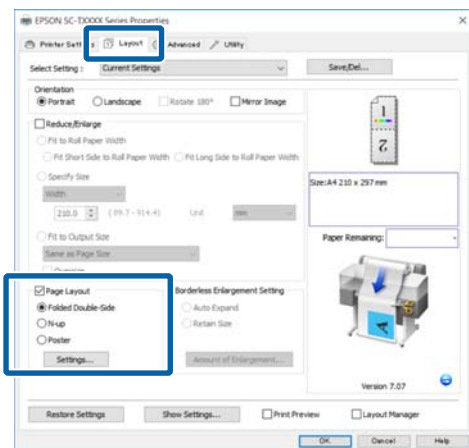

2 In the **Folded Double-Side Setting** dialog box, set **Binding Edge** and **Binding Margin**.

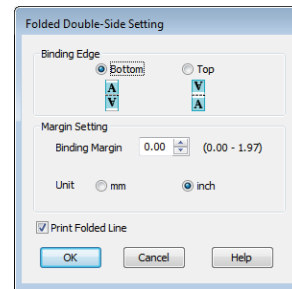

3 Check other settings, and then start printing.

N-up

Note:

- In Windows, you cannot use the N-up printing function when performing borderless printing.
- In Windows, you can use the Reduce/Enlarge function (Fit to Page) to print the data on different sizes of paper.

[“Printing at Non-Standard Sizes” on page 93](#)

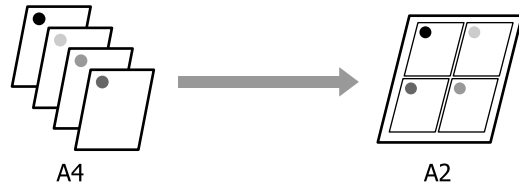

Making Settings in Windows

1 In the printer driver's Layout tab, select **Page Layout**. Next, select **N-up** and click the **Settings** button.

[“Basic Printing Methods\(Windows\)” on page 58](#)

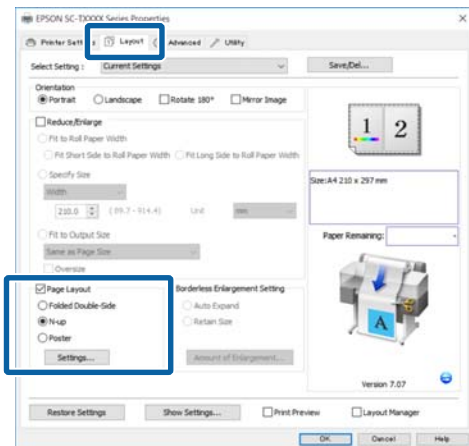

More Ways to Print

- 2 In the Print Layout dialog box, select the **Number of pages per sheet** and **Page Order**.

If the **Print page frames** check box is selected, page frames are printed on each page.

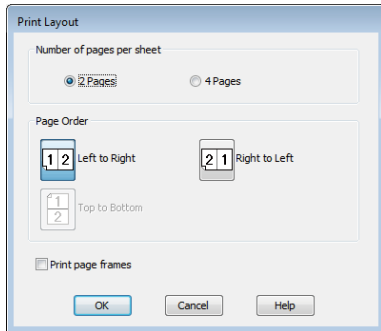

- 3 Check other settings, and then start printing.

Making Settings for Mac OS X

- 1 When the Print screen is displayed, select **Layout** from the list, and then specify the number of pages per sheet and so on.

[“Basic Printing Methods\(Mac OS X\)” on page 62](#)

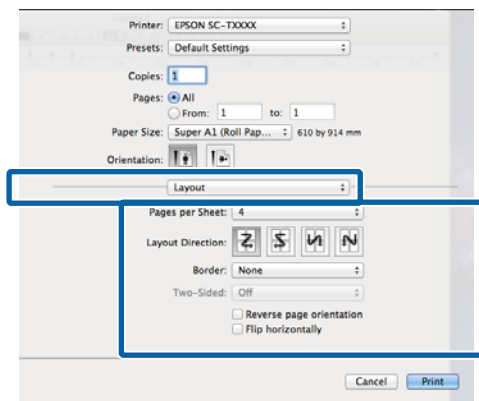

Note:
You can print frames around arranged pages using the **Border** function.

- 2 Check other settings, and then start printing.

Poster (Windows only)

- 1 In the printer driver's Layout tab, select **Page Layout**. Next, select **Poster** and click the **Settings** button.

[“Basic Printing Methods\(Windows\)” on page 58](#)

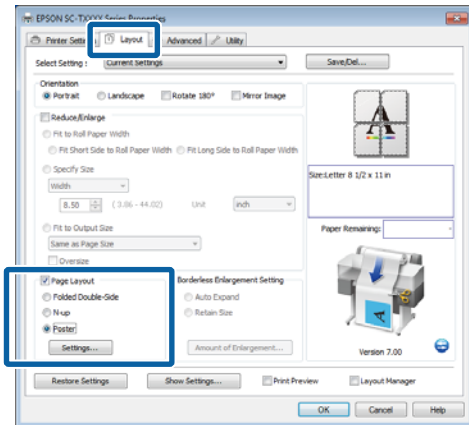

- 2 In the Poster Settings dialog box, select the **Number of panels**.

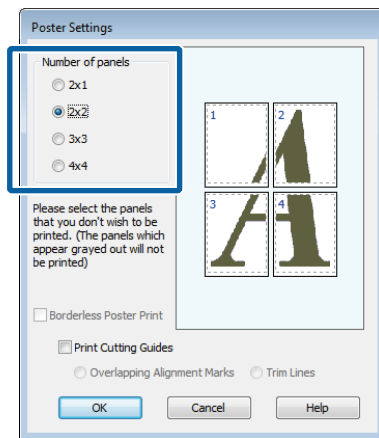

More Ways to Print

3 Enable or disable borderless printing.

When borderless is selected:
Select **Borderless Poster Print**.

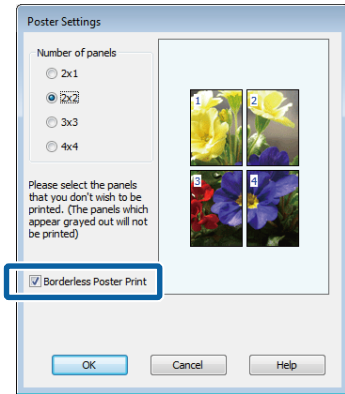

Note:

If **Borderless Poster Print** is grayed out, the selected paper or the size does not support borderless printing.

[“Supported Media Sizes for Borderless Printing” on page 102](#)

[“Epson Special Media Table” on page 212](#)

If **Single Cut** or **Double Cut** is selected for **Auto Cut**, the paper will be cut 1 or 2 mm inside the image, resulting in imperfect joins.

When with margins is selected:
Clear **Borderless Poster Print**.

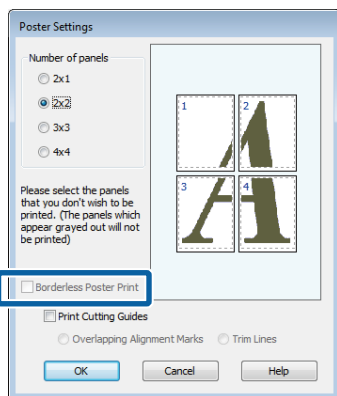

Note:

Regarding the size after joining together:

If **Borderless Poster Print** is not selected, a **Print Cutting Guides** option will be displayed.

The finished size is the same whether or not **Trim Lines** is selected. However, if **Overlapping Alignment Marks** is selected, the finished size is smaller with an overlap.

4 Check other settings, and then start printing.

Joining Poster Sheets with Printed Borders

If **Overlapping Alignment Marks** is selected, join guides (indicated by the lines drawn through and around the X marks in the illustration below) will be printed on each sheet.

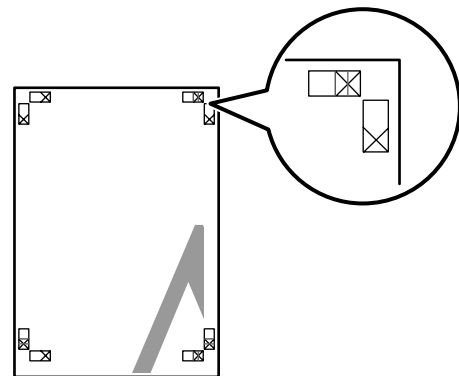

Note:

If the output is in color, the join guides will be in blue and the cut guides in red; otherwise, all the guides will be printed in black.

More Ways to Print

The following section describes how to join four printed pages together.

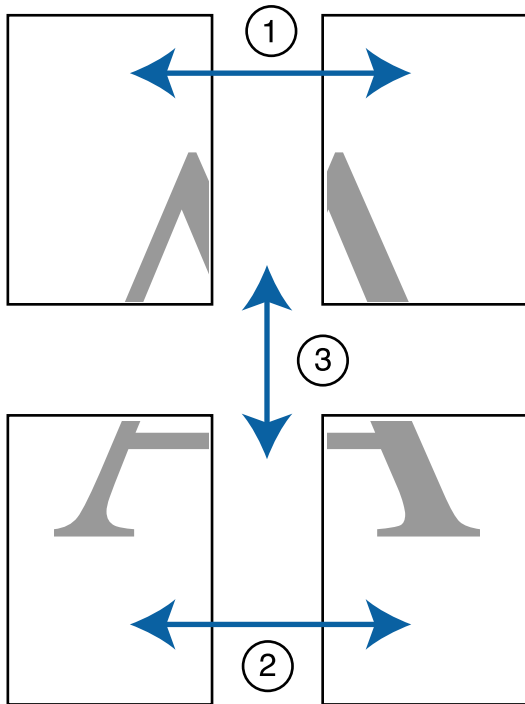

- 1 Ready the two top sheets and trim the excess from the left sheet by cutting along the line joining the two join guides (the centers of the X marks).

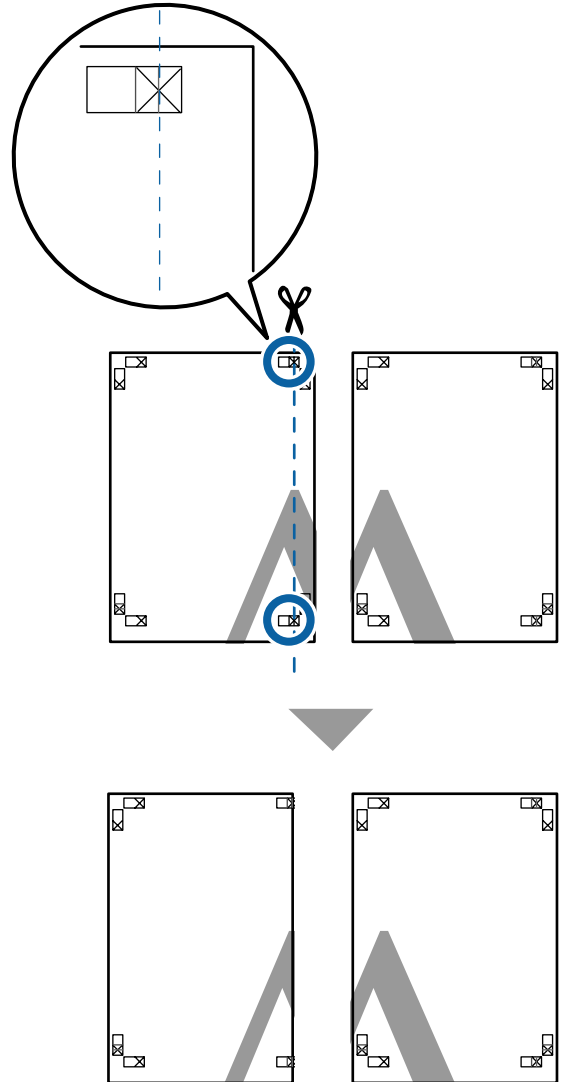

- 2 Lay the upper left sheet on top of upper right sheet. Lineup the X marks as shown in the illustration below, and temporarily fasten them using an adhesive tape on the back.

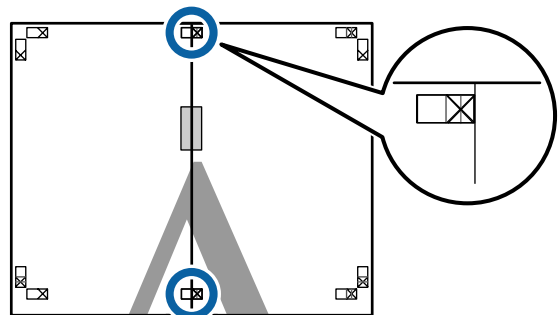

More Ways to Print

- 3** With the two sheets overlapping, trim the excess by cutting along the line joining the two cut guides (the lines to the left of the X marks).

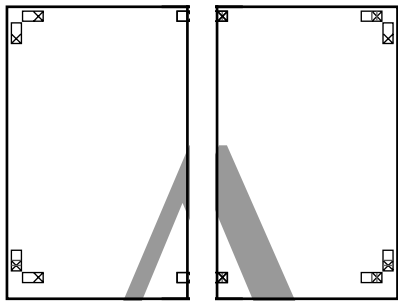
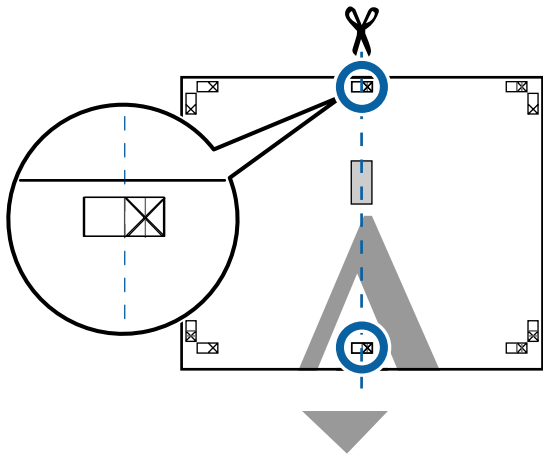

- 4** Rejoin the two sheets.
Use an adhesive tape to stick the backs of the sheets together.

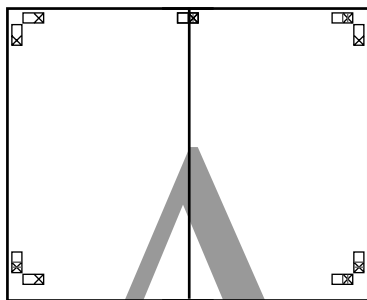

- 5** Repeat Steps 1 to 4 for the lower sheets.

- 6** Trim the bottom from the upper sheets by cutting along the line joining the two guides (the lines above the X marks).

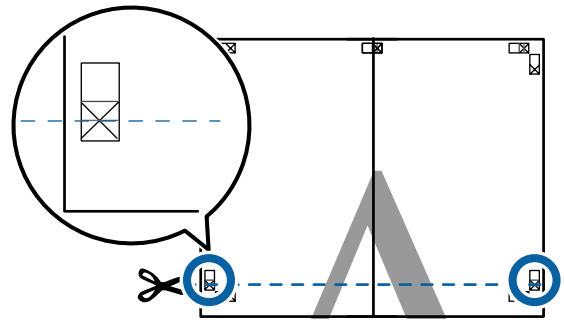

- 7** Lay the upper sheet on top of the lower sheet. Lineup the X marks as shown in the illustration below, and temporarily fasten them using an adhesive tape on the back.

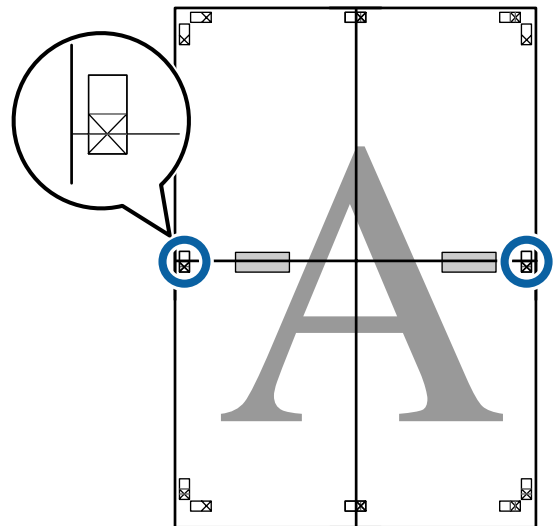

More Ways to Print

- 8** With the two sheets overlapping, trim the excess by cutting along the line joining the two cut guides (the lines above the X marks).

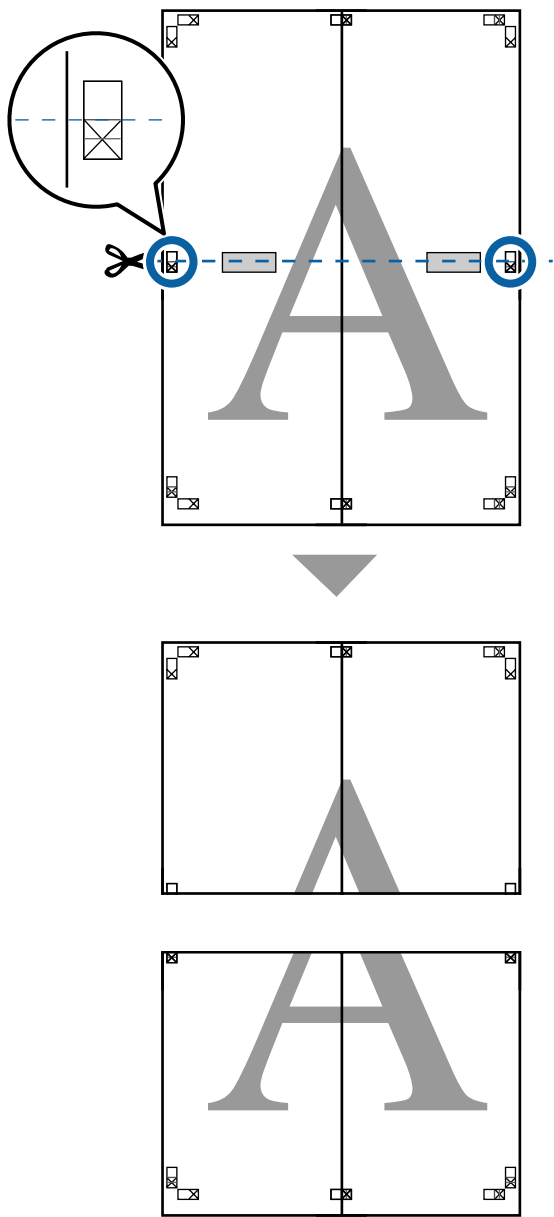

- 9** Join the upper and lower sheets together.
Use an adhesive tape to stick the backs of the sheets together.

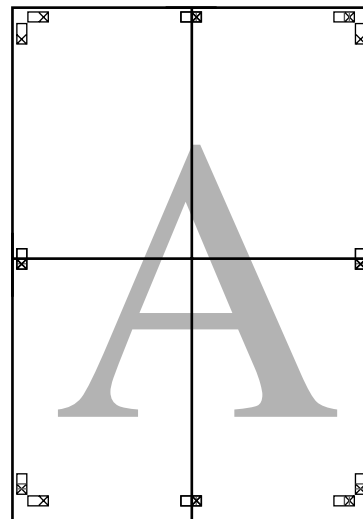

More Ways to Print

10 After joining all the sheets, trim off the borders by cutting along the cut guides (outside the X marks).

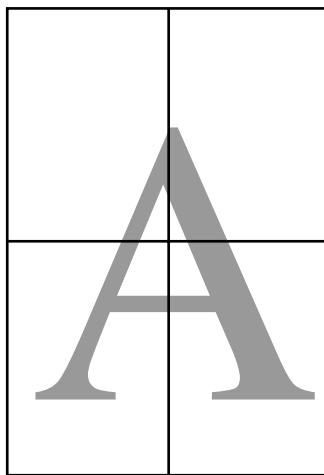
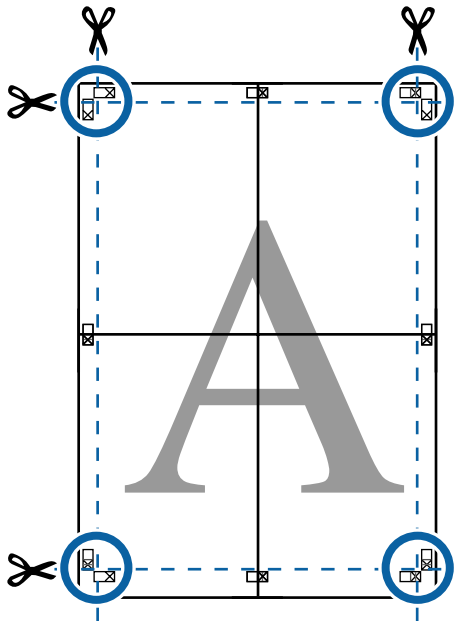

Printing Multiple Documents (the Layout Manager) (Windows Only)

Documents created in different applications can be printed together in your choice of layout. The Layout Manager can be used to improve efficiency and conserve paper.

Sample Multi-Document Layout

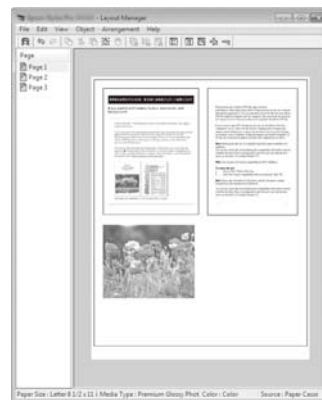
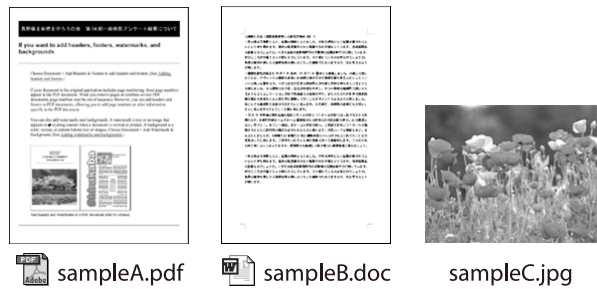

Sample Free Vertical/Horizontal Layout

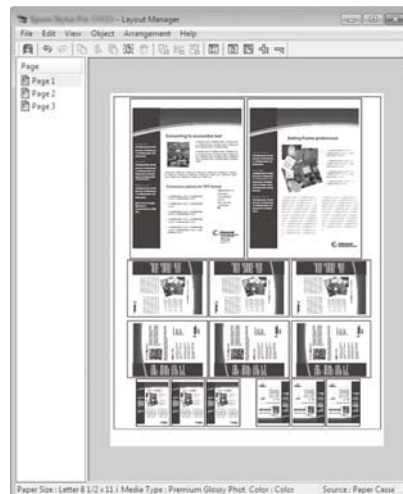

More Ways to Print

Setting Procedures for Printing

- 1 Open the file you want to print in your application.
- 2 In the printer driver's Printer Settings tab, select **Layout Manager** and in the **Size Settings** area select the **Paper Size** chosen for the document in the source application.

☞ “Basic Printing Methods(Windows)” on page 58

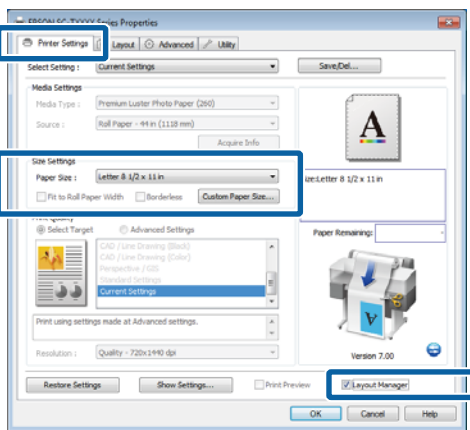

Note:
The **Paper Size** is the size of the document in the **Layout Manager**. The actual printing paper size is set in the screen in Step 6.

- 3 Click **OK**. When printing with an application, the **Layout Manager** screen opens.

The print data is not printed, but one page is placed on the paper of the **Layout Manager** screen as one object.
- 4 Leaving the **Layout Manager** screen open, repeat Steps 1 to 3 until all the documents have been added to the layout.

The objects are added to the **Layout Manager** screen.
- 5 Arrange the objects on the **Layout Manager** screen.

Objects can be dragged to new positions and resized; in addition, they can be rearranged or rotated using the options in the **Object** menu.

The overall size and placement of the objects can be changed using the **Preferences** and **Arrangement** options in the **File** menu.

See the **Layout Manager** screen help for more details on each function.

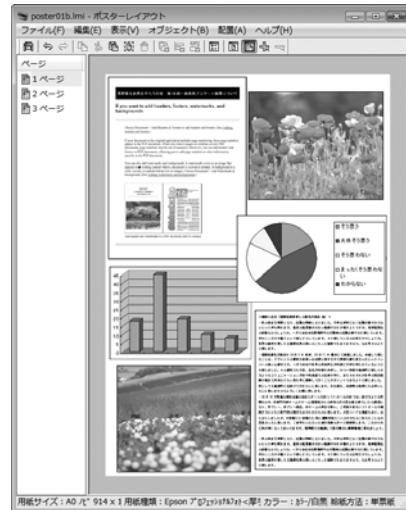

- 6 Click **Properties** in the **File** menu and adjust printer settings in the printer driver dialog.

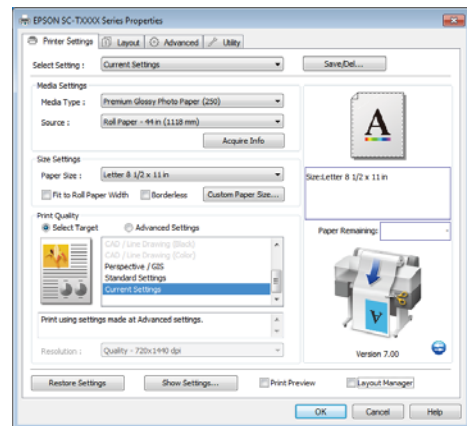

Check the **Media Settings** and choose a **Print Quality**.

- 7 Click the **File** menu on the **Layout Manager** screen, and then click **Print**.

Printing starts.

Saving and Recalling Settings

You can save the **Layout Manager** screen arrangement and setting contents to a file. If you need to close your application in the middle of a job, you can save it to a file and then open it later to continue your work.

More Ways to Print

Saving

- 1 On the Layout Manager screen, click **File** menu and then **Save As**.
- 2 Enter the file name, select the location, and then click **Save**.
- 3 Close the Layout Manager screen.

Opening saved files

- 1 Right-click the Utility shortcut icon on the Windows Taskbar () , and then click **Layout Manager** on the menu displayed.

The Layout Manager screen is displayed.

If the Utility shortcut icon is not displayed on the Windows Taskbar  [“Overview of the Utility Tab” on page 130](#)

- 2 On the Layout Manager screen, click **File** menu and then **Open**.
- 3 Select the location and open the required file.

Color Management Printing

Color Management Printing

About Color Management

Even when using the same image data, the original image and the displayed image may look different, and the printed results may look different to the image you see on the display. This occurs due to the difference in characteristics when input devices such as scanners and digital cameras capture colors as electronic data, and when output devices such as display screens and printers reproduce colors from the color data. The color management system is a means to adjust differences in color conversion characteristics among input and output devices. A color management system is included with operating systems such as Windows and Mac OS, in addition to image processing applications. Windows and Mac OS X include the ICM and ColorSync color management systems, respectively.

In a color management system, a color definition file called a "Profile" is used to perform color matching between devices. (This file is also called an ICC profile.) The profile of an input device is called an input profile (or source profile), and the profile of an output device, such as a printer, is called a printer profile (or output profile). A profile is prepared for each media type in this printer's driver.

The color conversion areas by the input device and the color reproduction area by the output device differ. As a result, there are color areas that do not match even when performing color matching using a profile. In addition to specifying profiles, the color management system also specifies conversion conditions for areas where color matching failed as "intent". The name and type of intent vary depending on the color management system you are using.

You cannot match the colors on the printed results and display by color management between the input device and the printer. To match both colors, you need to perform color management between the input device and the display as well.

Color Management Print Settings

You can perform color management printing using this printer's printer driver in the following two ways.

Choose the best method according to the application you are using, the operating system environment, the aim of the print out, and so on.

Setting color management with the applications

This method is for printing from applications that support color management. All color management processes are carried out by the application's color management system. This method is useful when you want to obtain the same color management print results using a common application among different operating system environments.

[🔗 “Setting color management with the applications” on page 121](#)

Setting color management with the printer driver

The printer driver uses the operating system's color management system and carries out all color management processes. You can make color management settings in the printer driver using the following two methods.

Host ICM (Windows) / ColorSync (Mac OS X)

Set when printing from applications that support color management. This is effective in producing similar print results from different applications under the same operating systems.

[🔗 “Color management printing by Host ICM \(Windows\)” on page 122](#)

[🔗 “Color management printing by ColorSync \(Mac OS X\)” on page 123](#)

Driver ICM (Windows only)

This allows you to perform color management printing from applications that do not support color management.

[🔗 “Color management printing by Driver ICM\(Windows Only\)” on page 124](#)

Color Management Printing

Setting profiles

Settings for the input profile, printer profile, and intent (matching method) vary between three types of color management printing since their color management engines are used differently. This is because color management usage differs between the engines. Make settings in the printer driver or application as described in the following table.

	Input profile settings	Printer profile settings	Intent settings
Driver ICM (Windows)	Printer Driver	Printer Driver	Printer Driver
Host ICM (Windows)	Application	Printer Driver	Printer Driver
ColorSync (Mac OS X)	Application	Printer Driver	Application
Application	Application	Application	Application

Printer profiles for each paper type that is needed when performing color management are installed with the printer's printer driver.

You can select the profile from the printer driver's settings screen.

[“Color management printing by Driver ICM\(Windows Only\)” on page 124](#)

[“Color management printing by Host ICM \(Windows\)” on page 122](#)

[“Color management printing by ColorSync \(Mac OS X\)” on page 123](#)

[“Setting color management with the applications” on page 121](#)

Setting color management with the applications

Setting color management with the applications Print using applications with a color management function. Make the color management settings in the application and disable the printer driver's color adjustment function.

- 1 Make color management settings in the applications.

Example of Adobe Photoshop CS5

Open the Print screen.

Select **Color Management** and then **Document**. Select **Photoshop Manages Colors** as the **Color Handling** setting, select the **Printer Profile** and the **Matching Method**, and then click **Print**.

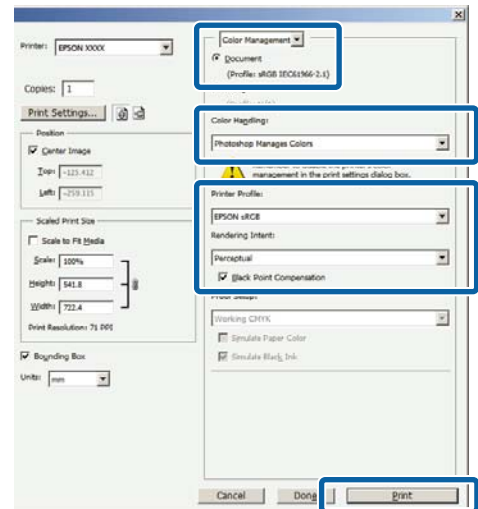

- 2 Display the printer driver's settings screen (Windows) or Print screen (Mac OS X).

Make printer driver settings.

For Windows

[“Basic Printing Methods\(Windows\)” on page 58](#)

For Mac OS X

[“Basic Printing Methods\(Mac OS X\)” on page 62](#)

Color Management Printing

3 Set color management to off.

For Windows

In the Printer Settings tab, select **Advanced Settings** in the **Print Quality** area and choose **Off (No Color Management)** for **Color Mode**.

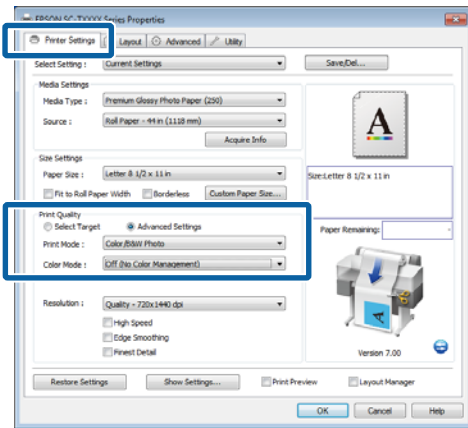

For Mac OS X

Choose **Printer Settings** from the list and select **Advanced Settings** for **Mode**. Select **Off (No Color Management)** for **Color Mode**.

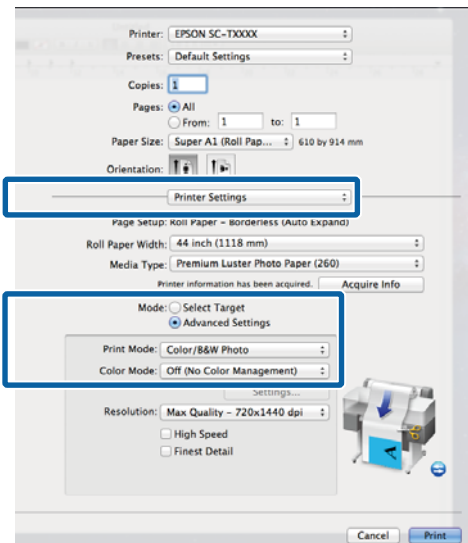

4 Check other settings, and then start printing.

Setting color management with the printer driver

Color management printing by Host ICM (Windows)

Use image data in which an input profile has been embedded. Also, the application must support ICM.

1 Make the settings for color adjustment using the application.

Depending on the type of the application, make the settings following the table below.

- Adobe Photoshop CS3 or later
- Adobe Photoshop Elements 6 or later
- Adobe Photoshop Lightroom 1 or later

OS	Color Management Settings
Windows 10, Windows 8.1, Windows 8, Windows 7, Windows Vista	Printer Manages Colors
Windows XP (Service Pack 2 or later and .NET 3.0 or later)	Printer Manages Colors
Windows XP (other than the above)	No Color Management

In other applications, set **No Color Management**.

Note:
For information on supported platforms, see the website for the application in question.

Example of Adobe Photoshop CS5

Open the Print screen.

Color Management Printing

Select **Color Management** and then select **Document**. Select **Printer Manages Colors** as the **Color Handling** setting, and then click **Print**.

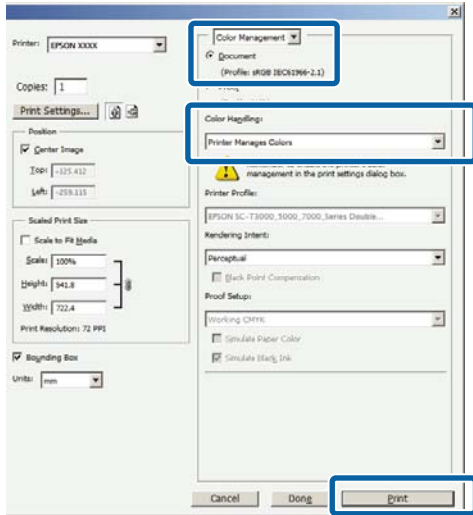

When using applications without a color management function, start from Step 2.

- 2 In the printer driver's Printer Settings tab, select **Advanced Settings** for **Print Quality**, then select **ICM** for **Color Mode** and click **Settings**.

[“Basic Printing Methods\(Windows\)” on page 58](#)

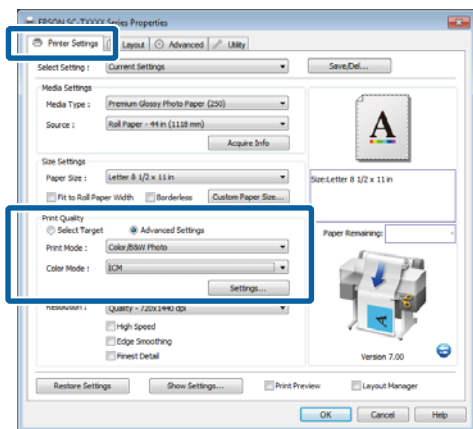

- 3 Select **Host ICM**.

When Epson special media is selected for **Media Type** in the Printer Settings tab, the printer profile corresponding to the media type is automatically selected and displayed in the **Printer Profile Description** box.

To change the profile, select **Show all profiles** at the bottom.

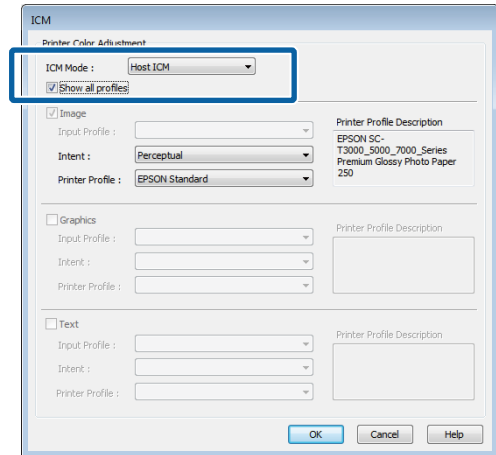

- 4 Check other settings, and then start printing.

Color management printing by ColorSync (Mac OS X)

Use image data in which an input profile has been embedded. Also, the application must support ColorSync.

Note:
Depending on the application, color management printing by **ColorSync** may not be supported.

- 1 Disable the color management functions in the application.

- 2 Display the Print screen.

[“Basic Printing Methods\(Mac OS X\)” on page 62](#)

- 3 Select **Color Matching** from the list, and then click **ColorSync**.

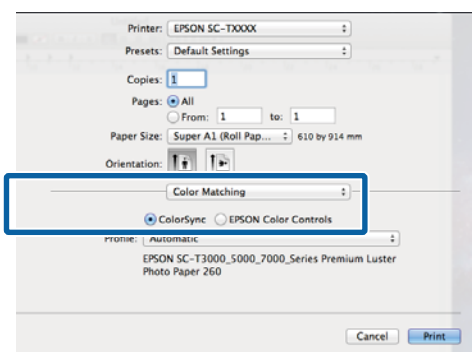

Color Management Printing

- Choose **Printer Settings** from the list and select **Advanced Settings** for **Mode**. Select **Off (No Color Management)** for **Color Mode**.

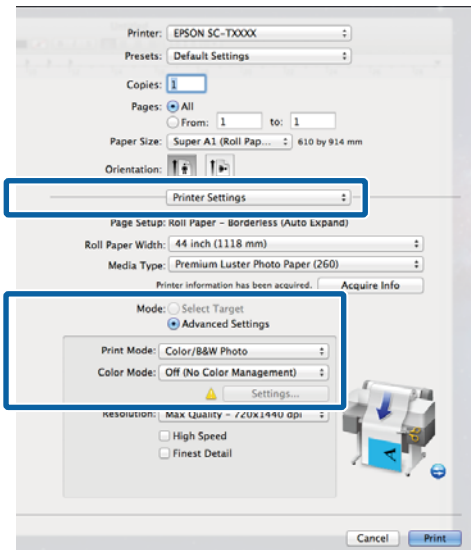

- Check other settings, and then start printing.

Color management printing by Driver ICM (Windows Only)

The printer driver uses its own printer profiles to perform color management. You can use the following two color correction methods.

- Driver ICM (Basic)

Specify one type of profile and intent for processing the entire image data.

- Driver ICM (Advanced)

The printer driver distinguishes the image data into the **Image**, **Graphics**, and **Text** areas. Specify three types of profiles and intents for processing each area.

When using applications featuring a color management function

Make the settings for color processing using the application before making printer driver settings.

Depending on the type of the application, make the settings following the table below.

Adobe Photoshop CS3 or later
 Adobe Photoshop Elements 6 or later
 Adobe Photoshop Lightroom 1 or later

OS	Color Management Settings
Windows 10, Windows 8.1, Windows 8, Windows 7, Windows Vista	Printer Manages Colors
Windows XP (Service Pack 2 or later and .NET 3.0 or later)	
Windows XP (other than the above)	No Color Management

In other applications, set **No Color Management**.

Note:

For information on supported platforms, see the website for the application in question.

Example of Adobe Photoshop CS5

Open the Print screen.

Select **Color Management** and then select **Document**. Select **Printer Manages Colors** as the **Color Handling** setting, and then click **Print**.

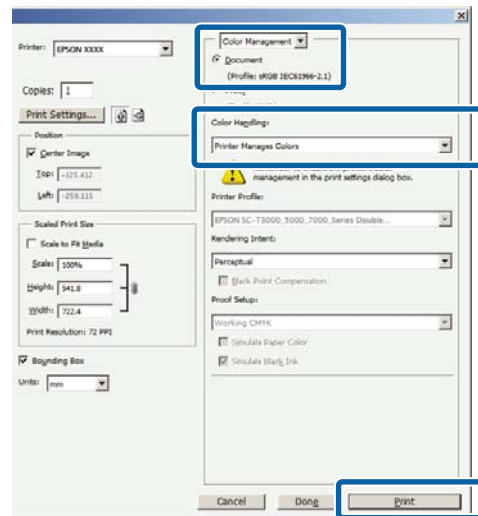

Color Management Printing

- 1 In the printer driver's Printer Settings tab, select **Advanced Settings** for **Print Quality**, then select **ICM** for **Color Mode** and click **Settings**.

📖 “Basic Printing Methods(Windows)” on page 58

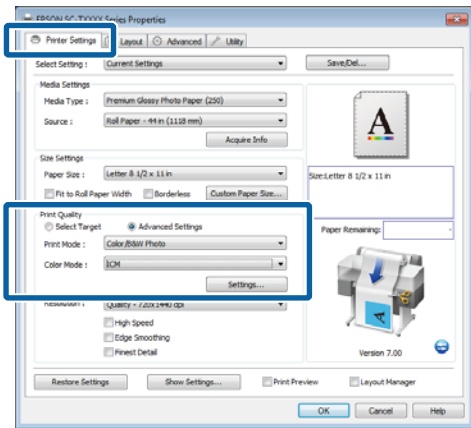

- 2 From **ICM Mode** in the ICM screen, select **Driver ICM (Basic)** or **Driver ICM (Advanced)**.

If you select **Driver ICM (Advanced)**, you can specify the profiles and intent for each image such as photos, graphics, and text data.

Intent	Explanation
Absolute Colorimetric	Assigns absolute color gamut coordinates to the original and print data and converts the data. Therefore, color tone adjustment is not performed on any white point (or color temperature) for the original or print data. This feature is used for special purposes such as logo color printing.

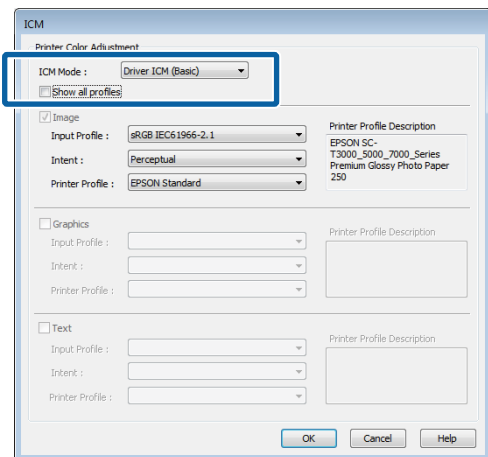

- 3 Check other settings, and then start printing.

Intent	Explanation
Saturation	Keeps the current saturation unchanged and converts the data.
Perceptual	Converts the data so that a more visually natural image is produced. This feature is used when a wider gamut of color is used for image data.
Relative Colorimetric	Converts the data so that a set of color gamut and white point (or color temperature) coordinates in the original data match their corresponding print coordinates. This feature is used for many types of color matching.

Tips for Using the Printer Driver(Windows)

Tips for Using the Printer Driver (Windows)

Displaying the Settings Screen

You can access the printer driver in the following ways:

- ❑ From Windows applications

 [“Basic Printing Methods\(Windows\)” on page 58](#)

- ❑ With the Start button

From the control panel

Follow the steps below when specifying common settings among applications or performing printer maintenance, such as Nozzle Check or Head Cleaning.

- 1 Open **Devices and Printers**.

For Windows 10/Windows 8.1/Windows 8/Windows 7

Click in the following order: **Hardware and Sound** (or **Hardware**) > **Devices and Printers**.

For Windows Vista

Click in the following order: **Hardware and Sound** and then **Printer**.

For Windows XP

Click in the following order: **Printers and Other Hardware**, and then **Printers and Faxes**.

Note:

*If your Windows XP Control Panel is in **Classic View**, click **Start**, **Control Panel**, and then **Printers and Faxes**.*

- 2 Right-click your printer icon, and click **Printing preferences**.

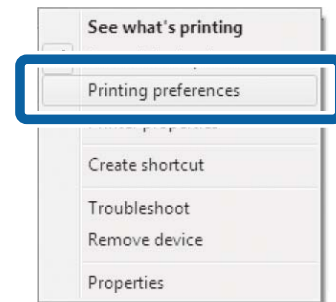

The printer driver dialog will be displayed.

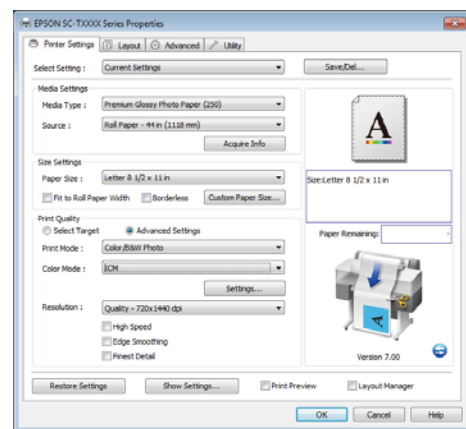

Make the necessary settings. These settings become the default settings of the printer driver.

Tips for Using the Printer Driver(Windows)

Displaying Help

You can access the printer driver help in the following ways:

- ❑ Click **Help**
- ❑ Right-click on the item you want to check and display

Click the Help Button to Display

By displaying **help**, you can use the contents page or keyword search to read the help.

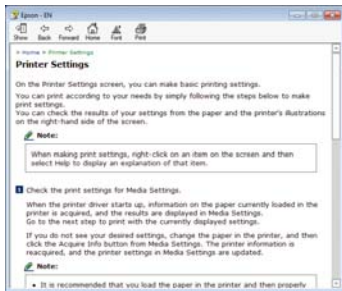
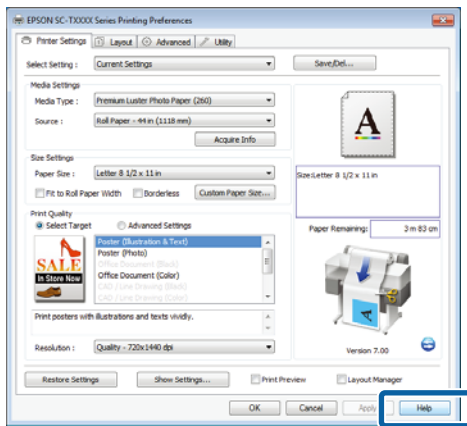

Right-click on the item you want to check and display

Right-click the item, and then click **Help**.

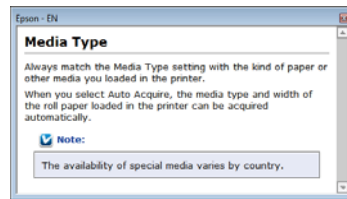
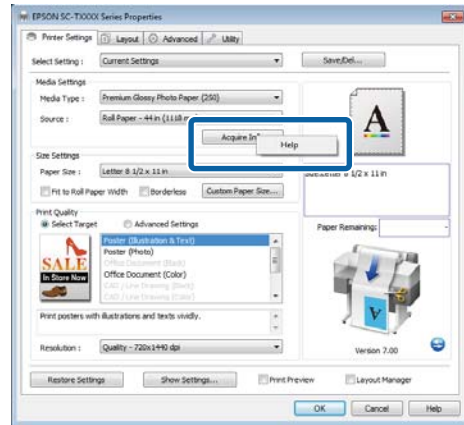

Note:
 In Windows XP, click **?** on the title bar, and then click the help item you want to view.

Tips for Using the Printer Driver(Windows)

Customizing the Printer Driver

You can save the settings or change the display items as you prefer.

Saving various settings as your Select Settings

All printer driver settings can be saved to **Select Setting**. In addition, **Select Setting** contains pre-defined settings recommended for a variety of common situations.

Recall **Select Setting** to increase efficiency if you often print at the same settings.

1 In the Printer Settings, Layout, and Advanced tabs, select the settings you wish to save to **Select Setting**.

2 Click **Save/Del.**

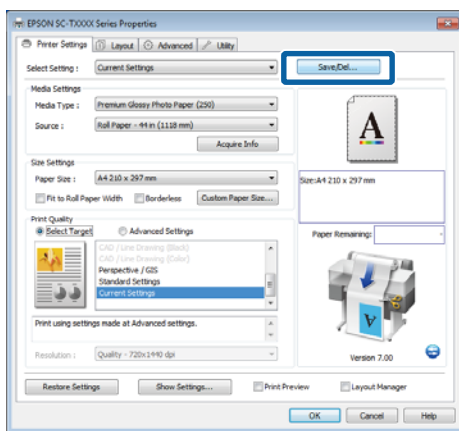

3 Enter any name in the **Name** box, and then click **Save**.

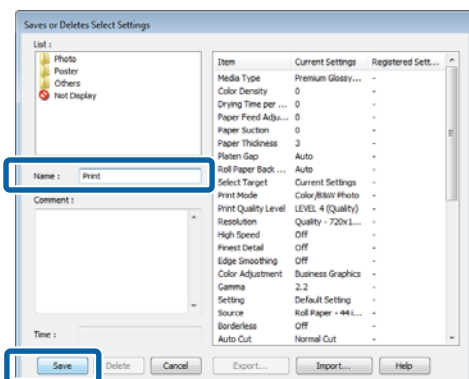

You can save up to 100 settings. You can choose a setting you have registered from the **Select Setting** list box.

Note:

You can save the settings as a file by clicking **Export**. You can share the settings by clicking **Import** to import the saved file on another computer.

Adding Media Types

Select **Print Quality** and **Media Settings** for the type of media you wish to add and save it as a custom media type. The custom media type will be added to the Media Type menu in the **Media Settings** area.

1 In the Printer Settings tab, select **Advanced Settings** and adjust settings as desired.

Note:

You can not add a custom media type if **Select Target** is selected in the **Print Quality** area.

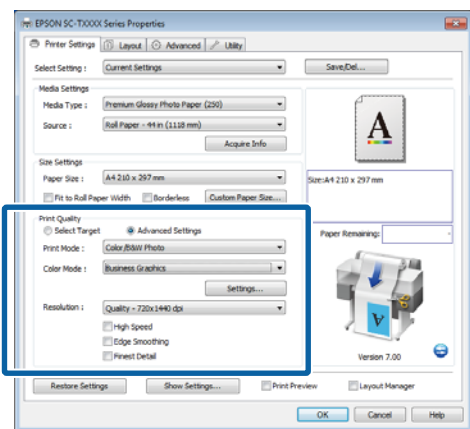

2 Click **Advanced Media Control** in the **Advanced** tab.

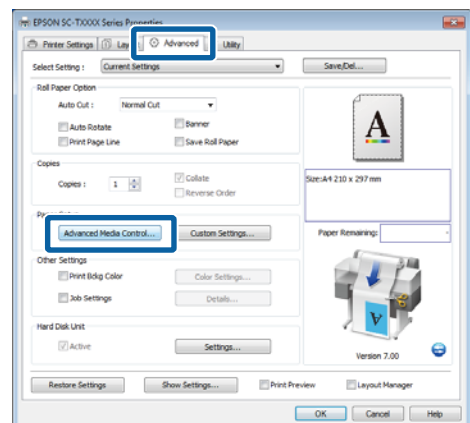

Tips for Using the Printer Driver(Windows)

- Adjust settings for the new custom media and click **OK**.

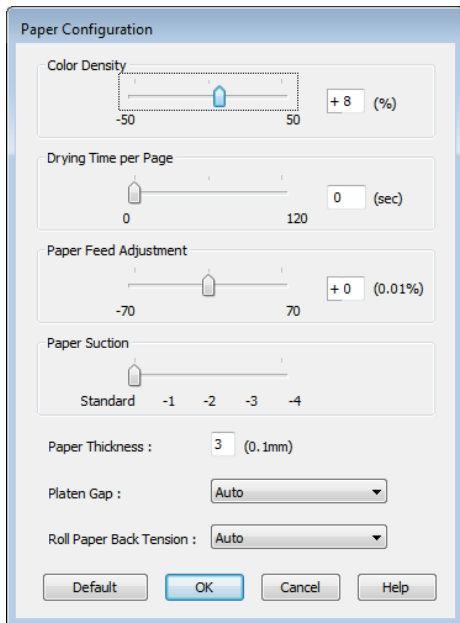

- Click **Custom Settings** in the Advanced tab.

- Enter any name in the **Name** box, and then click **Save**.

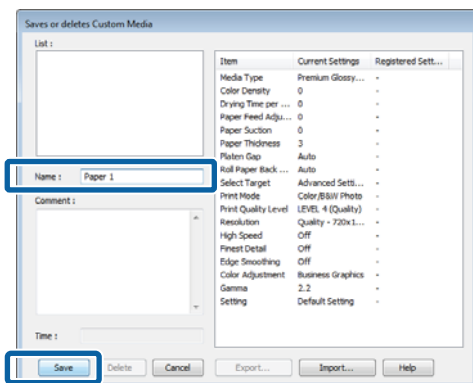

You can save up to 100 settings. You can choose a setting you have registered from the **Media Type** list box.

Note:

You can save the settings as a file by clicking **Export**. You can share the settings by clicking **Import** to import the saved file on another computer.

Rearranging display items

To display frequently used items right away, you can arrange **Select Setting**, **Media Type**, and **Paper Size** as follows.

- Hide unnecessary items.
- Rearrange in an order of most frequent use.
- Arrange in groups (folders).

- Go to the **Utility** tab and click **Menu Arrangement**.

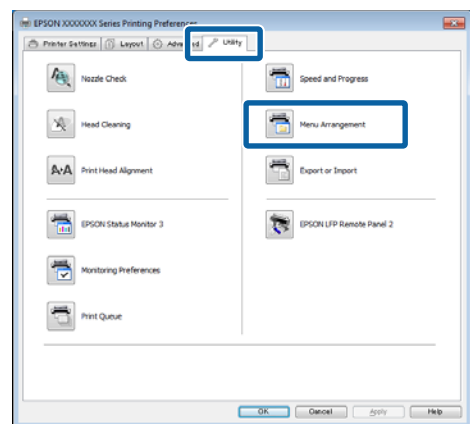

- Select **Edit Item**.

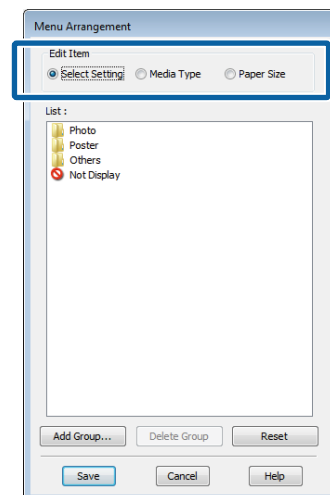

- Order or group items in the **List** box.

- You can move and order items by dragging and dropping.
- To add a new group (folder), click **Add Group**.

Tips for Using the Printer Driver(Windows)

- ❑ To delete a group (folder), click **Delete Group**.
- ❑ Drag and drop unnecessary items to **Not Display**.

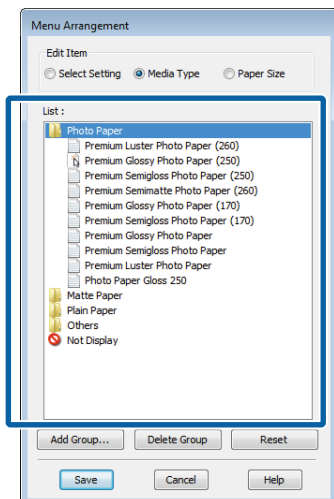

Note:

When **Delete Group** is performed, the group (folder) is deleted, however the items in the deleted group (folder) remain.

4

Click **Save**.

Overview of the Utility Tab

The printer driver's Utility tab provides access to the following.

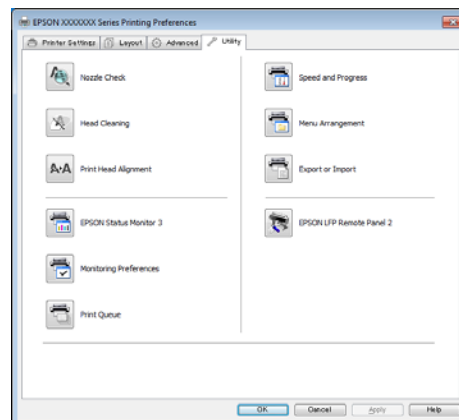

Nozzle Check

This function prints a nozzle check pattern to check if the print head nozzles are clogged. If you see banding or gaps in the print outs, perform head cleaning to clear any clogged nozzles.

[“Cleaning the print head” on page 180](#)

Head Cleaning

If you see banding or gaps in the print outs, perform head cleaning. Cleans the surface of the print head to improve the print quality.

[“Cleaning the print head” on page 180](#)

Print Head Alignment

If the print results appear grainy or out of focus, perform Print Head Alignment. The Print Head Alignment function adjusts the misalignment of the printhead that occurs during printing.

[“Aligning print position misalignment \(Head Alignment\)” on page 181](#)

EPSON Status Monitor 3

You can check the printer's status, such as the remaining ink level and error messages, on the computer's screen. When roll paper is loaded on Roll 1 or Roll 2 of the SC-T7200D Series/SC-T5200D Series, you can also check which is selected an operational object (in use).

Tips for Using the Printer Driver(Windows)

SC-T7200 Series/SC-T5200 Series/SC-T3200 Series



SC-T7200D Series/SC-T5200D Series



Monitoring Preferences

You can select the error notifications displayed on the EPSON Status Monitor 3 screen, or register a shortcut for the Utility icon to the Taskbar.

Note:

If you select the **Shortcut Icon** on the Monitoring Preferences screen, the Utility shortcut icon is displayed on the Windows Taskbar.

By right-clicking the icon, you can display the following menu and perform maintenance functions.

EPSON Status Monitor 3 starts when the printer name is clicked from the displayed menu.

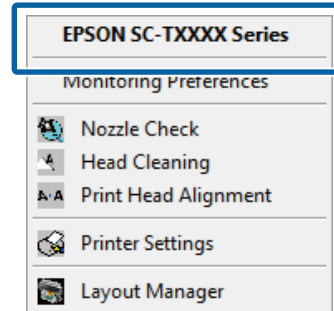

Print Queue

You can display the list of all waiting jobs.

On the Print Queue screen, you can view information on the data waiting to be printed, delete and reprint these jobs.

Speed and Progress

You can set various functions for printer driver basic operations.

Menu Arrangement

You can arrange the display items of **Select Setting**, **Media Type**, and **Paper Size**. For example, you can reorder them by frequency of access. [☞ “Rearranging display items” on page 129](#)

Export or Import

You can export or import the printer driver settings. This function is useful when you want to make the same printer driver settings on multiple computers.

EPSON LFP Remote Panel 2

You can configure custom paper settings and other settings. See the EPSON LFP Remote Panel 2 help for details.

Note:

If **EPSON LFP Remote Panel 2** is grayed out, EPSON LFP Remote Panel 2 is not installed. Install EPSON LFP Remote Panel 2 from the Software List in the Software disc.

Tips for Using the Printer Driver(Windows)

Uninstalling the printer driver

Follow the steps below to remove the printer driver and EPSON LFP Remote Panel 2.



Important:

- You must log in with an Administrators group.
- In Windows 7/Windows Vista, if an Administrator password or confirmation is requested, enter the password and then continue with the operation.

- 1** Turn off the printer, and unplug the interface cable.
- 2** Go to the **Control Panel** and click **Uninstall a program** from the **Programs** category.



- 3** Select the software you want to remove and then click **Uninstall/Change** (or **Change/Remove/Add or remove**).

You can remove **EPSON Status Monitor 3** and the printer driver by selecting **EPSON SC-XXXXX Printer Uninstall**.

Select **EPSON LFP Remote Panel 2** to remove EPSON LFP Remote Panel 2.

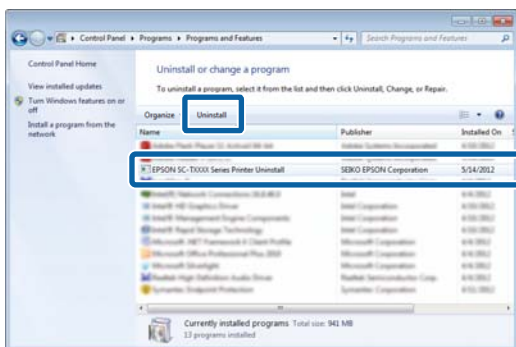

- 4** Select the target printer icon, and then click **OK**.

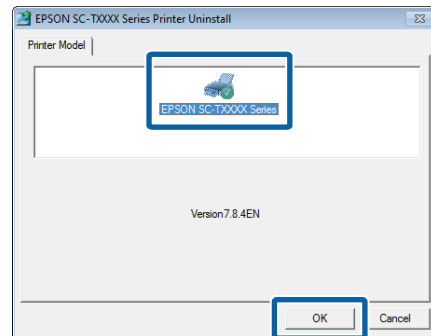

- 5** Follow the on-screen instructions to continue.
When the delete confirmation message appears, click **Yes**.

Restart the computer if you are reinstalling the printer driver.

Tips for Using the Printer Driver(Mac OS X)

Tips for Using the Printer Driver (Mac OS X)

Displaying the Settings Screen

The display method of the printer driver setting screen may differ depending on the application or the OS version.

 [“Basic Printing Methods\(Mac OS X\)” on page 62](#)

Displaying Help

Click  in the printer driver setting screen to display Help.

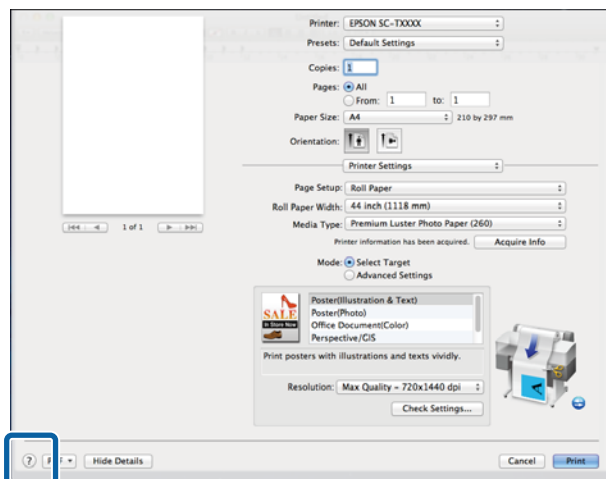

Using Epson Printer Utility 4

You can perform maintenance tasks such as Nozzle Check or Head Cleaning by using Epson Printer Utility 4. This utility is installed automatically when you install the printer driver.

Starting Epson Printer Utility 4

Mac OS X 10.6.x or later

- 1 Select **System Preferences > Print & Scan** (or **Print & Fax**) from the **Apple** menu.
- 2 Select the printer and click **Options & Supplies > Utility > Open Printer Utility**.

Mac OS X 10.5.8

- 1 Select **System Preferences > Print & Fax** from the **Apple** menu.
- 2 Select the printer and click **Open Print Queue > Utility**.

Epson Printer Utility 4 Functions

You can perform the following maintenance functions from Epson Printer Utility 4.

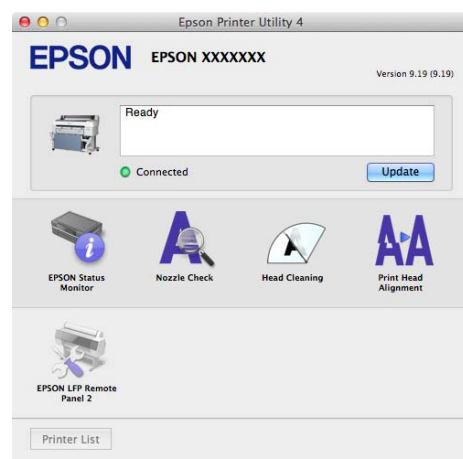

Tips for Using the Printer Driver(Mac OS X)

EPSON Status Monitor

You can check the printer's status, such as the remaining ink level and error messages, on the computer's screen. When roll paper is loaded on Roll 1 or Roll 2 of the SC-T7200D Series/SC-T5200D Series, you can also check which is selected to be operating (in use).

SC-T7200 Series/SC-T5200 Series/SC-T3200 Series

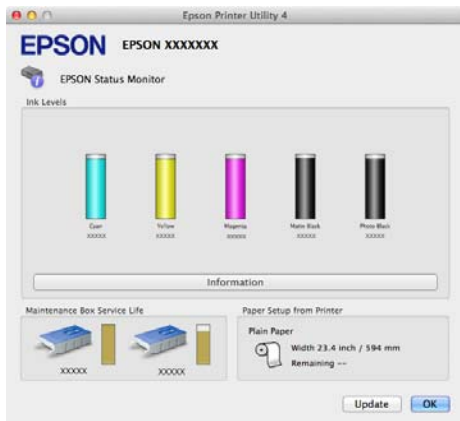

SC-T7200D Series/SC-T5200D Series



Nozzle Check

This function prints a nozzle check pattern to check if the print head nozzles are clogged. If you see banding or gaps in the print outs, perform head cleaning to clear any clogged nozzles.

[“Cleaning the print head” on page 180](#)

Head Cleaning

If you see banding or gaps in the print outs, perform head cleaning. This function cleans the surface of the print head to improve the print quality.

[“Cleaning the print head” on page 180](#)

Print Head Alignment

If the print results appear grainy or out of focus, perform Print Head Alignment. The Print Head Alignment function corrects print head gaps.

[“Aligning print position misalignment \(Head Alignment\)” on page 181](#)

EPSON LFP Remote Panel 2

You can configure custom paper settings and other settings. See the EPSON LFP Remote Panel 2 help for details.

Tips for Using the Printer Driver(Mac OS X)

Uninstalling the printer driver

Before reinstalling or upgrading the printer driver or EPSON LFP Remote Panel 2, uninstall the affected software.

Use the Uninstaller to uninstall the printer driver.

Downloading the Uninstaller

Download the Uninstaller from the Epson website.

<https://www.epson.com/>

Using the Uninstaller

Follow the instructions on the Epson website.

Removing EPSON LFP Remote Panel 2

Drag and drop the **EPSON Remote Panel 2** folder from the **Applications** folder into the **Trash**.

Using the Control Panel Menu

Using the Control Panel Menu

Menu Operations

The steps for displaying the various menus are shown below.

The example below shows the steps for accessing the Paper menu.

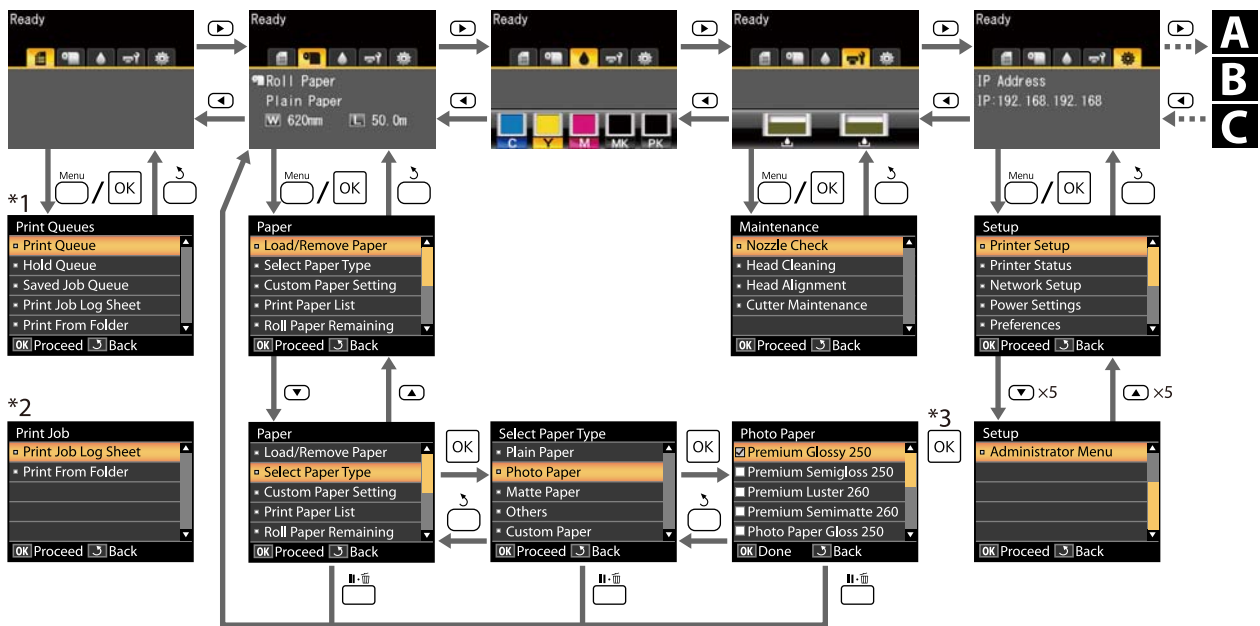

*1 Available when the optional hard disk unit or Adobe PostScript 3 Expansion Unit has been connected

*2 Standard menu (when the hard disk unit or Adobe PostScript 3 Expansion Unit has not been connected)

*3 After pressing the OK button to select the highlighted option, press the \leftarrow button to return to the previous menu. Press the \square button to exit.

A Displayed only when an A3 or A4 scanner is connected

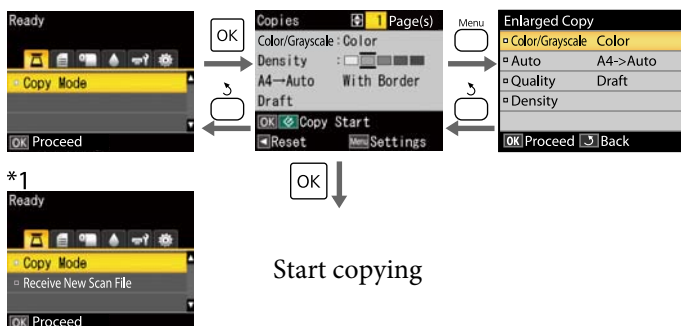

Start copying

Using the Control Panel Menu

B When the optional MFP Scanner is connected

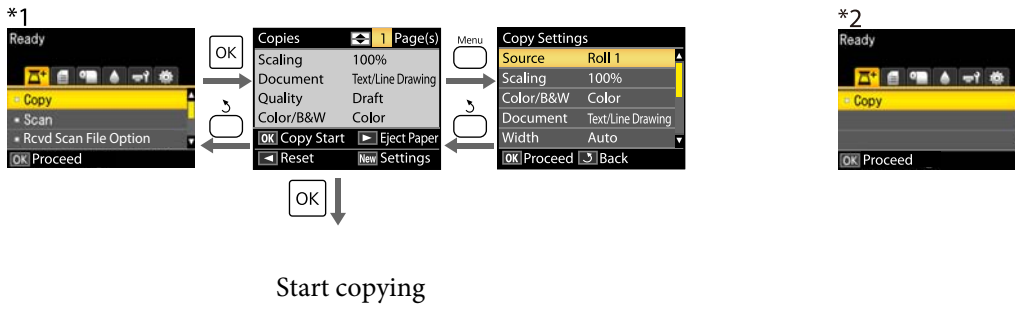

C Available when the optional hard disk unit or Adobe PostScript 3 Expansion Unit has been installed and the MFP scanner is not installed

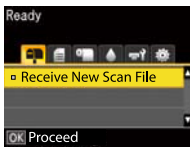

When received scan files or scan files are saved to the hard disk unit or the Adobe PostScript 3 Expansion Unit

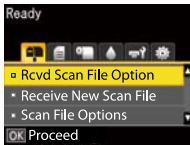

Using the Control Panel Menu

Menu List

The items and options available in the menu are described below. See the reference pages for more details on each item.

*1: SC-T7200D Series/SC-T5200D Series only

*2: SC-T7200 Series/SC-T5200 Series/SC-T3200 Series only

*3: Only when optional hard disk unit or Adobe PostScript 3 Expansion Unit is installed

*4: Only when optional Adobe PostScript 3 Expansion Unit is installed

 **Print Queues menu**

 [“Print Queues menu” on page 147](#)

Menu item		Description
Print Queue* ³	XXXXXXXXXXXX (name of waiting print job)	Lists the Waiting Job Name, User, Estimated Start Time, Estimated Print Time, and Printing Availability.
Hold Queue* ^{2, 3}	View Hold Queue XXXXXXXXXXXX (name of paused job)	Lists the Paused Job Name, User, Paper Type, Source, Size, and Reason For Hold.
	Resume All Jobs	Press OK to start printing.
Savd Job Queue* ³	XXXXXXXXXXXX (name of stored print job)	Display thumbnails Stored Job Name, User, Paper Length, Pages, Paper Type, Copies, Source, Size, or Estimated Print Time are displayed when ► is pressed Selecting OK displays a print/delete menu
Print Job Log Sheet		Press OK to start printing.
Print From Folder	XXXXXXXXXXXX (displays the file name)	File Name, Source, and Preview are displayed Press OK to start printing (Printing starts after the print preview is displayed when Preview is enabled.)

 **Paper menu**

 [“Paper menu” on page 149](#)

Menu item		Description
Load/Remove Paper	Remove Paper	Not displayed when no paper is loaded
	Roll Paper* ²	Displays instructions for loading the paper.
	Roll 1* ¹	
	Roll 2* ¹	
	Cut Sheet (up to 0.8 mm thick)	
	Poster Board	

Using the Control Panel Menu

Menu item		Description		
Select Paper Type	Plain Paper	Lists supported Epson media.		
	Photo Paper			
	Matte Paper			
	Others			
	Custom Paper	Lists the names of user-defined custom paper types.		
Custom Paper Setting XXXXXXXXXXXX XXXXXXXXXX (name of custom paper type)	Select Reference Paper	Plain Paper	Lists supported Epson media.	
		Photo Paper		
		Matte Paper		
		Others		
		No Paper Selected	No Paper Selected	
	Platen Gap	Narrow, Standard, Wide, Wider		
	Detect Paper Thickness	Press OK to start printing.		
	Paper Feed Adjust	Pattern	Press OK to start printing.	
		Value	-0.70 to +0.70%	
	Paper Suction	-4 to 0		
	Roll Paper Tension	Normal, High, Extra High		
	Remove Skew	On, Off		
	Setting Name	22 characters or less (letters, numbers, and symbols)		
Restore Settings	Yes, No			
Print Paper List		Press OK to start printing.		
Roll Paper Remaining		On, Off		
Remaining Alert		1 to 15m		

Maintenance menu

 [“Maintenance menu” on page 153](#)

Menu item	Description
Nozzle Check	Press OK to start printing.

Using the Control Panel Menu

Menu item		Description
Head Cleaning		
Head Alignment	Auto(Uni-D)	Press OK to start printing/alignment.
	Auto(Bi-D)	
	Manual(Uni-D)	Press OK to start printing.
	Manual(Bi-D)	
Cutter Maintenance	Adjust Cut Position	-3 to 3mm
	Replace Cutter	Press OK to start move.

⚙️ Setup menu

[👉 “Setup menu” on page 154](#)

Using the Control Panel Menu

Menu item		Description		
Printer Setup	Roll Paper Setup	Auto Cut	On, Off	
		Cutting Mode	Normal, Silent	
		Refresh Margin	On, Off	
		Page Line	On, Off	
		Roll Paper Margin	Normal, Top15mm/Bottom15mm, Top 35 mm/Bottom 15 mm, Top 45 mm/Bottom 15 mm, 3 mm,15 mm	
		Roll End Option	Continue, Stop Printing, Reprint ^{*3}	
		Auto Loading ^{*1}	On, Off	
		Roll Switch Setting ^{*1}	Auto, Roll 1, Roll 2	
		Roll Switch Condition ^{*1}	Paper Type	Type Match, Disable
			Paper Length	Print Length, Remaining Amount, Disable
			Paper Width	Best Fit, Width Match, Disable
	Print Job Priority ^{*3}		Roll In Use, In Order	
	Advanced Settings	Roll Paper Tension	1 to 5	
		Less Head Scuffing	On, Off	
		Drying Time Per Page	Off to 60 min	
		Paper Size Check	On, Off	
		Paper Skew Check	On, Off	
		Store Held Job ^{*3}	On, Off	
		USB Timeout	10 to 600 sec	
Quick Cut		On, Off		

Using the Control Panel Menu

Menu item		Description			
	HP-GL/2 Settings	Quality	Speed, Fine		
		Output Size	Auto, A Series, US-ANSI, US-ARCH, B Series, Photo Series, Others, User Defined		
		Margin	3mm, 5mm		
		Margin Options	Standard, Add Margins, Clip By Margins		
		Rotate	0°, 90°, 180°, 270°		
		Mirror	On, Off		
		Select Palette	Software, Default, Palette A, Palette B		
		Define Palette	Palette A	Pen Number	Pen Width, Pen Color
			Palette B	Pen Number	Pen Width, Pen Color
		Line Merge	On, Off		
		Save To HDD	Print And Save, Print Only		
	Reset HP-GL/2 Settings	Yes, No			
Restore Settings	Yes, No				

Using the Control Panel Menu

Menu item		Description	
Option Setup*4	PS3 Expansion Unit	Version	PostScript Version, PDF Version
		PS Status Sheet	Press OK to start printing.
		Output Size	Auto, A Series, US-ANSI, US-ARCH, B Series, Photo Series, Others, User Defined
		Margin Options	Standard, Add Margins, Clip By Margins
		Quality	Speed, Normal, Fine
		Color Mode	Color, Grayscale
		Dot Correction	On, Off
		CMYK Simulation	SWOP v2, US Web Uncoated v2, US Sheetfed Coated v2, US Sheetfed Uncoated v2, Coated GRACoL 2006, SWOP Grade 3 Paper, SWOP Grade 5 Paper, Coated FOGRA27, Web Coated FOGRA28, Uncoated FOGRA29, Coated FOGRA39, Euroscale Coated v2, Euroscale Uncoated v2, JapanWebCoated (Ad), JapanColor2001Coated, JapanColor2001Uncoated, JapanColor2002Newspaper, JapanColor2003WebCoated, EPSON_TOYO, EPSON_DIC, Off
		RGB Source	sRGB, Adobe RGB (1998), Apple RGB, ColorMatch RGB, Off
		Rendering Intent	Absolute, Relative, Perceptual, Saturation
		Black Pt Compensation	On, Off
		Auto Rotate	On, Off
		Caching To HDD	On, Off
		PS Error Sheet	On, Off
Save To HDD	Print And Save, Print Only		
Printer Status	Firmware Version	xxxxxxx,x.xx,xxxx	
	Option Status	Displays the options connected.	
	Show Total Prints	XXXXXX m ²	
	Print Status Sheet	Press OK to start printing.	

Using the Control Panel Menu

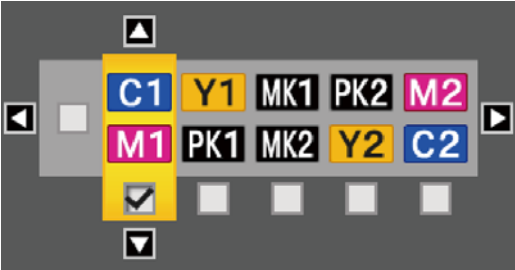
Menu item		Description
Network Setup	IP Address Setting	Auto
		Panel
		-
		IP Address, Subnet Mask, Default Gateway
	IPv6 Setting	Enable, Disable
	IPsec Setting	Enable, Disable
	PSK Setting	Set key at 20 characters or less (half-size characters or symbols)
	IEEE802.1x Setting	Enable, Disable
	HTTPS Redirect Setting	Enable, Disable
	Print Status Sheet	Press OK to start printing.
	Restore Settings	Yes, No
Power Settings	Sleep Mode	5 to 210 minutes
	Power Off Timer	Off, 1 to 24 hours
	Restore Settings	Yes, No
Preference	Language	Lists the supported languages.
	Unit: Length	m, ft/in
	Alert Lamp Setting	On, Off
Administrator Menu	Change Password	Enter a password.
	Operational Control	Network Setup
		Password Required, No Password Required
	Power Cleaning	
	Format HDD ^{*3}	Non-Secure (Quick) Secure (Quick) Secure (Sanitizing)
		Formatting is executed if you approve it in the confirmation message.
	Printer Mode	Auto, PostScript ^{*4} , HP-GL/2
	Date And Time	MM/DD/YY HH:MM
	Time Zone	Enter the time difference between GMT and the current time zone.
	Reset PS Settings ^{*4}	Yes, No
Reset All Settings	Yes, No	

Using the Control Panel Menu

Enlarged Copy menu

Displayed only when a A3 or A4 scanner has been connected to the printer.

 [“Enlarged Copy menu” on page 173](#)

Menu item		Description	
Color/Grayscale		Color, Grayscale	
Auto	A3->Auto, B4->Auto, A4->Auto, B5->Auto, A5->Auto, LTR->Auto, 4x6->Auto, A4/2->Banner(Auto)	With Border, Borderless	
	Other Size	Document Size	A3, B4, A4, B5, A5, LTR, 4x6
		Output Size	A0, US E, B1, A1, US D, B2, US C, A2, A0(2Sheets)
		Border	With Border, Borderless
Quality		Speed, Fine	
Density		Five options from Light to Dark	

Large Copy / Large Scan menu

This menu is displayed only when the optional MFP Scanner is connected.

 [“Large Copy / Large Scan menu” on page 174](#)

Menu item		Description	
Copy Settings	Source	Roll Paper/Roll 1*1, Roll 2*1, Roll Auto*1, Cut Sheet	
	Scaling	Manual	25 to 400%
		Auto	
	Color/Grayscale		Color, Grayscale
	Document type		Text/Line Drawing, Tracing Paper, Recycled Paper, Blueprint, Blueprint Inverted, Poster
	Width		Auto, ISO A, US-ANSI, US-ARCH, JIS B, ISO B, cm, inch
	Quality		Speed, Fine
	Margin Options		Clip By Margins, Add Margins, Borderless
	Density		Level -3 to 3
	Contrast		Level -3 to 3
	Background		Level -3 to 3
	Sharpness		Level -3 to 3

Using the Control Panel Menu

Menu item		Description
Scan Setting ^{*3}	Color/Grayscale	Color, Grayscale, B&W
	Document type	Text/Line Drawing, Tracing Paper, Recycled Paper, Blueprint, Blueprint Inverted, Poster
	Width	Auto, ISO A, US-ANSI, US-ARCH, JIS B, ISO B, cm, inch
	Save Image type	JPEG, PDF, TIFF
	Resolution	100dpi, 200dpi, 300dpi, 360dpi, 400dpi, 600dpi
	File Size Compression	High, Normal, Low
	Density	Level -3 to 3
	Contrast	Level -3 to 3
	Background	Level -3 to 3
	Sharpness	Level -3 to 3

Using the Control Panel Menu

Menu Descriptions

Print Queues menu

When the printer printed without using the printer driver included with the printer or the PS driver included with the optional Adobe PostScript 3 Expansion Unit, the job names and estimated times in the following table may not be displayed correctly.

*1: SC-T7200D Series/SC-T5200D Series only

*2: SC-T7200 Series/SC-T5200 Series/SC-T3200 Series only

*3: Only when optional hard disk unit or Adobe PostScript 3 Expansion Unit is installed

*4: Only when optional Adobe PostScript 3 Expansion Unit is installed

Item		Description
Print Queue ^{*3}	XXXXXXXXXX (name of waiting print job)	<p>Waiting Job Name User Estimated Start Time Estimated Print Time Printing Availability</p> <p>Lists the estimated start time and time needed to print the selected job.</p> <p>It also predicts whether the job can be completed without replacing paper, ink or the Maintenance Box. The estimates are guidelines only. We recommend proceeding even if Can Not Complete is displayed.</p> <p>Remote Manager and the LFP HDD Utility display the reason for the Can Not Complete message and allow you to hold or cancel the job.</p> <p> "Function Summary" on page 69</p> <p>Printing availability by paper remaining cannot be performed correctly if Roll Paper Remaining is Off.</p> <p>The printer will not predict availability on the basis of the amount of ink remaining when documents are printed using LFP Print Plug-In for Office or EPSON CopyFactory5.</p> <p>When the printer printed using the PS driver included with the optional Adobe PostScript 3 Expansion Unit, Estimated Start Time and Estimated Print Time are displayed as "0 minutes".</p>
Hold Queue ^{*2, *3}	View Hold Queue	<p>XXXXXXXXX XXX (name of paused job)</p> <p>Paused Job Name User Paper Type Source Size Reason For Hold</p> <p>This option is available only if On is selected for Store Held Job in the Setup menu,</p> <p>Displays the print settings for held jobs and the reason the job is held.</p> <p>Jobs that are held because the job print settings differ from those currently selected for the printer can be printed as described below.</p> <p>(1) Replace the paper and take whatever other steps may be necessary to ready the device for printing.</p> <p>(2) Select Resume All Jobs.</p>
	Resume All Jobs	Press the OK button to resume all held jobs currently in the queue.

Using the Control Panel Menu

Item		Description	
Savd Job Queue*3	XXXXXXXXXXXX (name of stored print job)	Thumbnail Stored Job Name User Paper Length Pages Paper Type Copies Source Size Estimated Print Time	<p>A thumbnail of the selected saved job is displayed. When you press the ► button, detailed information from the last time the file was printed is displayed.</p> <p>Detailed information is displayed for previously saved jobs that do not support thumbnails and a thumbnail is not displayed.</p> <p>If you press the OK button after confirmation, a print/delete menu appears.</p> <p>When Print is selected: a screen appears requesting entry of the number of copies. Press the ▲/▼ buttons to choose the number of copies and press the OK button to display the estimated print time and print availability. Press the OK button to start printing.</p> <p>When Delete is selected: A confirmation screen appears. Press the OK button to delete the job.</p>
Print Job Log Sheet		<p>Press the OK button to print the print job log.</p> <p>Notes on ink consumption</p> <p>This is a simple tool for estimating ink consumption for a given print job. EPSON DOES NOT WARRANT ACCURACY. Actual ink consumption varies considerably depending on such factors as software used, firmware version, image printed, print settings, substrate types, frequency of use, temperature, and variations in printer performance and user preferences and practices. Estimates do not account for ink used over the life of the cartridge for ink remaining in the cartridge after the replace cartridge signal. Some Epson printers have multiple tools for estimating cost or ink consumption and not all tools work the same way.</p>	
Print From Folder		<p>You can select a file in a shared folder on the network that has been setup in advance and print it.</p> <p> "Print From Folder" on page 86</p>	

Using the Control Panel Menu

Paper menu

If you use the **Custom Paper Setting** to register print settings for commercial paper on the SC-T7200D Series/SC-T5200D Series, observe the following precautions.

If you are printing on both the Roll 1 and Roll 2, configure them individually, even when the paper is the same. If the Custom Paper Setting set by the conditions set in Roll 1 is applied to the same type of paper loaded in Roll 2, but the paper path, paper width, or other print conditions are different, printing will not be performed correctly.

*1: SC-T7200D Series/SC-T5200D Series only

*2: SC-T7200 Series/SC-T5200 Series/SC-T3200 Series only

*3: Only when optional hard disk unit or Adobe PostScript 3 Expansion Unit is installed

*4: Only when optional Adobe PostScript 3 Expansion Unit is installed

* Default setting

Item		Description
Load/Remove Paper	Remove Paper	Instructions are not displayed if no paper is loaded.
	Roll Paper*2	Highlight the paper to be loaded and press the OK button. Follow the on-screen instructions to load the paper. If paper is already loaded in the printer, the instructions for removing the loaded paper type will be displayed before loading instructions are shown.
	Roll 1*1	
	Roll 2*1	
	Cut Sheet (up to 0.8 mm thick)	
	Poster Board	
Select Paper Type	Plain Paper	Select the type of paper loaded.
	Photo Paper	
	Matte Paper	
	Others	
	Custom Paper	Select the name of the custom paper loaded in the printer.

Using the Control Panel Menu

Item		Description			
Custom Paper Setting	XXXXXXXXXX (name of custom paper type)	Select Reference Paper	Plain Paper	You can select the media type that is the closest to the paper you are using.	
			Photo Paper		
			Matte Paper		
			Others		
				No Paper Selected	Select this option if you do not wish to specify the paper type.
		Platen Gap	Narrow	Select the platen gap, which is the distance between the print head and the paper. Normally, select Standard . Select a wider setting if printed images are smeared. If, upon performing head alignment, you feel that it is still not completely aligned, select Narrow .	
			Standard*		
			Wide		
			Wider		
			Detect Paper Thickness	Press the OK button to print a pattern to determine the thickness of the current paper. Select the pattern number with the least misalignment from the print results.	

Using the Control Panel Menu

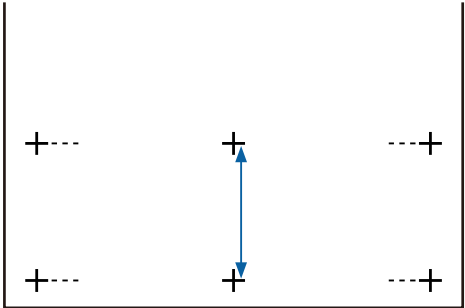
Item		Description	
	Paper Feed Adjust	Pattern	<p>Use this setting if you are unable to resolve banding issues (horizontal striped lines or uneven colors) in the standard print area (for cut sheets, the area excluding the 1 to 2 cm strip at the bottom of the paper) even after head cleaning or head alignment.</p> <p>Pattern selected</p> <p>Press the OK button to print an adjustment pattern. Measure the distance between the "+" symbols.</p> <p>Use only the distance between the center symbols or the average of the distances between the left, center, and right symbols.</p> 
		Value	<p>After the adjustment pattern is printed, the length of the pattern is displayed in the control panel. Press the ▲/▼ buttons to select the value measured with the scale and then press the OK button.</p> <p>Value selected</p> <p>Choose an adjustment between -0.70 and +0.70%.</p> <p>Selecting too small a value causes dark bands; adjust the amount upward. Similarly, choosing too large a value causes white bands; adjust the amount downward.</p>
	Paper Suction	-4 to 0 (0*)	<p>It is important to choose the appropriate amount of suction for the paper used in order to maintain the correct distance between the paper and the print head. Choosing too high a value for thin or soft paper will increase the distance between the paper and the print head, causing print quality to decline or preventing the paper feeding correctly. In such cases, you will need to lower the paper suction. The suction power is weakened when the parameter is lowered.</p>
	Roll Paper Tension	Normal* High Extra High	<p>Select High or Extra High if the paper wrinkles during printing.</p> <p>If Extra High is set, the following setting is enabled: Setup menu > Advanced Settings > Roll Paper Tension.</p>
Remove Skew	On* Off	<p>Select whether to enable (On) or disable (Off) paper skew reduction.</p>	

Using the Control Panel Menu

Item		Description	
	Setting Name	Enter a name of up to 22 characters for custom paper settings. Choose an easy-to-remember name for quick selection.	
	Restore Settings	Yes	Restore the selected custom paper settings to default values.
		No	
Print Paper List		Press the OK button to print a list of custom paper settings.	
Roll Paper Remaining		On*	<p>Select whether to display/record (On) or not to display/record (Off) the amount of remaining roll paper. If On is selected, you will be prompted to enter the length of the roll. The following options can be made available by entering the length of the loaded roll.</p> <ul style="list-style-type: none"> <input type="checkbox"/> Time until replacement <p>When the roll is removed, a barcode will automatically be printed on the roll stating the length remaining, the value selected for the roll remaining alert, and the paper type.</p> <p>The barcode is automatically read and settings adjusted the next time the paper is used, improving efficiency when multiple rolls of paper are used.</p> <input type="checkbox"/> Printing Availability <p>The printer will estimate printing availability based on the length of the roll.</p>
		Off	
Remaining Alert		1 to 15 m (5*)	<p>Displayed when On is selected for Roll Paper Remaining.</p> <p>Set within a range from 1 to 15 m to display a warning when the amount of remaining roll paper drops below that limit. You can set in 1 m increments.</p>

Using the Control Panel Menu

Maintenance menu

Item		Description	
Nozzle Check		Press the OK button to print a nozzle check pattern. Inspect the pattern visually and perform head cleaning if you detect faint or missing colors. ☞ "Checking for clogged nozzles" on page 179	
Head Cleaning		 <p>Inspect the printed pattern and select the check boxes for patterns with faint or missing areas. To select all nozzles, place a check in the box on the left. ☞ "Cleaning the print head" on page 180</p>	
Head Alignment	Auto(Uni-D)	If print results are grainy or out of focus, perform head alignment to realign the print head. If Auto is selected, the printer will scan the printed pattern during printing and realign the head automatically. If Manual is selected, a pattern will be printed; inspect the pattern visually and enter the value you think appropriate. ☞ "Aligning print position misalignment (Head Alignment)" on page 181	
	Auto(Bi-D)		
	Manual(Uni-D)		
	Manual(Bi-D)		
Cutter Maintenance	Adjust Cut Position	-3 to 3mm	You can fine tune the top cut position when printing to roll paper with no margins in all directions. The top cut position can be configured in increments of 0.2 mm.
	Replace Cutter	Moves the cutter to the replacement position so it can be replaced. Press the OK button to move the cutter to the replacement position. The paper must be removed before the cutter can be replaced. Remove the paper before proceeding. ☞ "Replacing the Cutter" on page 187	

Using the Control Panel Menu

Setup menu

Selecting **Administrator Menu** displays a password prompt. No password is entered at shipment; press the **OK** button to proceed. If the administrator password has been changed, enter the administrator password.

*1: SC-T7200D Series/SC-T5200D Series only

*2: SC-T7200 Series/SC-T5200 Series/SC-T3200 Series only

*3: Only when optional hard disk unit or Adobe PostScript 3 Expansion Unit is installed

*4: Only when optional Adobe PostScript 3 Expansion Unit is installed

* Default setting

Printer Setup

Roll Paper Setup

Item	Description	
Auto Cut	On*	Choose On to automatically cut roll paper using the built-in cutter as each page is printed or Off to disable auto paper cutting. The setting selected with the printer driver takes priority when the printer driver is used.
	Off	
Cutting Mode	Normal*	If you want to reduce operation noise during cutting, set Silent . If Silent is set, the cutting speed is reduced.
	Silent	
Refresh Margin	On*	If On is selected during borderless printing, the printer will automatically trim the leading edge to remove any ink stains that may have been left by the previous copy; to disable this feature, choose Off .
	Off	
Page Line	On*	If Auto Cut is Off , you can choose to print (On) or not print (Off) cut lines on roll paper. Cut lines are not printed if Auto Cut is On or when cut sheets or poster board is used. Note, however, that if the roll width selected with the computer is narrower than the paper loaded in the printer, cut lines will be printed regardless of the option selected for Auto Cut . The setting selected with the printer driver takes priority when the printer driver is used.
	Off	
Roll Paper Margin	Normal*	When set to Normal , the top and bottom margins are 15 mm, and the left and right margins are 3 mm. Except for 15 mm , the left and right margins for all other settings are 3 mm.  "Printable area" on page 65
	Top15mm/ Bottom15mm	
	Top35mm/ Bottom15mm	
	Top45mm/ Bottom15mm	
	3 mm	
	15 mm	

Using the Control Panel Menu

Item	Description	
Roll End Option	Continue	Select the action to perform for a roll after replacement: print the remaining data (Continue) / do not print (Stop Printing) / print again from the beginning (Reprint).
	Stop Printing*	
	Reprint* ³	<p>Data is not reprinted in the following situations, even when Reprint is configured.</p> <ul style="list-style-type: none"> <input type="checkbox"/> Using the PS Folder in the Adobe PostScript 3 Expansion Unit to print a password-protected PDF file <input type="checkbox"/> Printing while emulating HP-GL/2 and HP RTL <input type="checkbox"/> Large copying when the optional MFP Scanner is connected <input type="checkbox"/> Enlarged copying when the A3 or A4 scanner is connected
Auto Loading* ¹	On*	Normally, leave the setting at On .
	Off	<p>If you experience problems with automatic loading when you use commercially available paper because of lack of tension, slipperiness, extremely large curls, or other problems, set to Off.</p> <p>Remove all paper before configuring this setting. If paper is loaded, the setting cannot be changed.</p> <p>While the setting is Off, the Roll 2 unit cannot be used.</p>
Roll Switch Setting* ¹	Auto*	<p>Select the action to take when the roll currently in use is under the following conditions: automatically switch between Roll 1 and Roll 2 and print (Auto) / print fixed to Roll 1 (Roll 1)/print fixed to Roll 2 (Roll 2).</p> <ul style="list-style-type: none"> <input type="checkbox"/> The roll is finished, and there is data still to be printed. <input type="checkbox"/> The printer predicts that there is not enough roll paper remaining, and printing cannot be completed. <input type="checkbox"/> The print margin will be large for the width of the print job. <p>When the setting is Auto, the roll is switched according to the Roll Switch Condition setting.</p>
	Roll 1	
	Roll 2	

Using the Control Panel Menu

Item	Description		
Roll Switch Condition* ¹	Paper Type	Type Match*	<p>From the following options, select the condition under which to switch to another roll for printing when the current roll has run out.</p> <ul style="list-style-type: none"> <input type="checkbox"/> Type Match: Switch to the other roll for printing only when the paper type specified in the job and the paper type of the other roll are the same. <p>If a different type of paper has been loaded on the other roll, an error appears, and the printer cannot print.</p> <ul style="list-style-type: none"> <input type="checkbox"/> Disable: Print even when the paper type is different.
		Disable	
	Paper Length	Print Length*	<p>From the following options, select the conditions when you want to switch in consideration of roll paper remaining and print length (length of one page of a print job).</p> <p>Note that if Roll Paper Remaining is Off in the Paper menu, this setting is disabled regardless of its configuration.</p> <ul style="list-style-type: none"> <input type="checkbox"/> Print Length: If both Roll 1 and Roll 2 have enough paper remaining for the print length, print using the roll with the lower remaining amount. If the remaining amount of one roll is shorter than the print length, print using the other roll. <input type="checkbox"/> Remaining Amount: Print using the roll with the lower remaining amount regardless of the print length. <input type="checkbox"/> Disable: Print using the roll currently in use regardless of the remaining amount or print length.
		Remaining Amount	
		Disable	
	Paper Width	Best Fit*	<p>From the following options, select the conditions when you want to use the roll paper that reduces print margins in consideration of roll paper width and print job length (the value of Document Size of the printer driver).</p> <ul style="list-style-type: none"> <input type="checkbox"/> Best Fit: Compare the roll width of Roll 1 and Roll 2 and the width of the print job, and then print using the roll with the smaller print margin. <input type="checkbox"/> Width Match: Print using the roll with a width that matches the width of the print job. <input type="checkbox"/> Disable: Print using the roll currently in use regardless of the roll paper width or print job width.
		Width Match	
		Disable	
	Print Job Priority* ³	Roll In Use	<p>Select the print job priority when there are several waiting jobs: print jobs that can be printed by the roll currently in use, switch to another roll, and then print the remaining jobs (Roll In Use) / Print jobs in the order they were received (In Order). When the setting is In Order, automatic roll switching operations may be frequent depending on the settings of the print jobs, and this may increase the overall print time.</p>
		In Order*	

Using the Control Panel Menu

Advanced Settings

Item	Description	
Roll Paper Tension	1 to 5 (3 [*])	<p>This setting is used if one of the following settings are configured to Extra High: Paper menu > Custom Paper Setting > Roll Paper Tension or Printer driver's Paper Configuration > Roll Paper Tension.</p> <p>If wrinkles are formed on the paper during printing when the abovementioned Roll Paper Tension is High, set it to Extra High, and then configure the strength of the tension using this setting.</p> <p>Higher values produce higher tension.</p>
Less Head Scuffing	On	<p>If the paper is thick, the print head may scuff the print surface. Choose On to prevent scuffing. This option can be used to temporarily change the value selected for Custom Paper Setting > Platen Gap in the Paper menu. Note, however, that On has no effect when Wider is selected for Platen Gap.</p>
	Off [*]	
Drying Time Per Page	Off to 60 minutes (Off [*])	<p>Specify how long the printer pauses to allow the ink to dry after printing each page; choose from values between 0 and 60 minutes. Depending on the ink density or paper type, the ink may take a while to dry. If the ink blurs on the paper, set a longer time for drying the ink.</p> <p>The longer the drying time, the more time required for printing.</p>
Paper Size Check	On [*]	<p>Choose whether the printer automatically detects (On) or does not detect (Off) the paper width. Try choosing Off if a paper setting error is displayed when the paper is correctly loaded. Note, however, that the printer may print outside the paper when Off is selected. If it prints beyond the edges of the paper, the inside of the printer becomes dirty with ink. We generally recommend to operate with this setting set to On.</p> <p>The changed settings are applied after the paper is reloaded. Note that they are not applied if you just change the menu items.</p>
	Off	
Paper Skew Check	On [*]	<p>If On is selected, an error will be displayed in the control panel and printing will stop if the paper is skewed; select Off to disable this feature. On is recommended in most circumstances as skewed paper may cause the printer to jam.</p>
	Off	
Store Held Job ^{*2, *3}	On	<p>This setting is displayed if an optional hard disk unit or Adobe PostScript 3 Expansion Unit is connected. If On is selected, print jobs that require a paper type, source, or output paper size (width) that differs from those currently selected with the printer will be saved as held jobs; select Off to disable this feature.</p> <p>If Off is selected, an error will be displayed and will printing will stop if the source selected for the print job does not match that selected with the printer.</p> <p>When On is selected, printing will not stop if an error occurs; instead, jobs with non-matching settings will be saved to the hard disk unit or Adobe PostScript 3 Expansion Unit as held jobs. Held jobs can be printed from the Print Queue menu after the printer has been readied by, for example, loading the correct type of paper.</p> <p> "Function Summary" on page 69</p>
	Off [*]	
USB Timeout	10 to 600 seconds (10 [*])	<p>If printing stops mid-way when the printer and computer are connected by a USB cable, set a longer time.</p>

Using the Control Panel Menu

Item	Description	
Quick Cut	On*	Specify the cutting operation for printing multiple page jobs.
	Off	<p>If you turn this On, while the next job is printing, the preceding print job is cut when its end reaches the cutting position. This shortens the printing time because printing and cutting are done in tandem.</p> <p>However, this function is enabled when the following settings are done in the printer driver.</p> <ul style="list-style-type: none"> <input type="checkbox"/> Plain Paper is selected for Media Type. <input type="checkbox"/> Speed is selected as the Resolution for Print Quality. <p>Details for cutting operations are the same as Single Cut for Borderless printing. ↗ "About Roll Paper Cutting" on page 104</p> <p>If you turn this OFF, the next job starts printing after the preceding print job is fed to its cutting position and cutting is completed.</p>

HP-GL/2 Settings

Item	Description	
Quality	Speed	Choose Print Quality in view of image quality and print speed.
	Fine*	

Using the Control Panel Menu

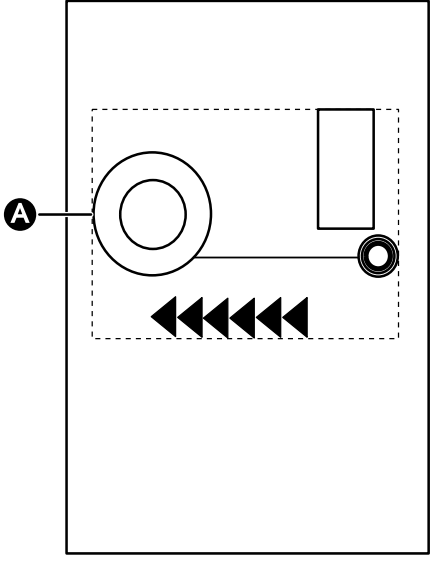
Item	Description	
Output Size	Auto*	<p>The hard clip area of the PS command of the data becomes the base output size. The actual output size depends on the Margin Options setting.</p> <p>When the data does not contain a PS command, the smallest rectangle area A of in the following illustration including the print object becomes the base output size.</p> 
	<p>A Series/US-ANSI/ US-ARCH/B Series/ Photo Series/ Others</p>	<p>Choose the base output size from the compatible standard sizes. The actual output size depends on the Margin Options setting.</p> <p>For a cut sheet, this setting is available only when the data does not contain a PS command.</p> <p>If the data contains a command, this setting is not available, and the hard clip area of the PS command becomes the base output size.</p>
	User Defined	<p>Select this option when outputting at non-standard sizes. After selecting this setting, set Paper Width and Paper Height. You can set in 0.1 mm increments.</p> <p>Paper Width</p> <p>SC-T7200 Series/SC-T7200D Series: 89*1 to 1,118 mm</p> <p>SC-T5200 Series/SC-T5200D Series: 89*1 to 914 mm</p> <p>SC-T3200 Series: 89*1 to 610 mm</p> <p>Paper Height</p> <p>127 to 4,620 mm</p> <p>The actual output size depends on the Margin Options setting.</p> <p>*1.The smallest size supported by the printer is 254 mm wide × 127 mm long. If a smaller size is entered for this setting, the document will print with wider-than-expected margins, which must be trimmed.</p>
Margin	3mm*	Select the top, bottom, left, and right margin values.
	5mm	For a cut sheet, the bottom margin is 14 mm regardless of the settings.

Using the Control Panel Menu

Item	Description
Margin Options	<p data-bbox="475 302 577 331">Standard*</p> <p data-bbox="703 302 1422 360">The position at which the margin is added depends on the Output Size setting, as shown below.</p> <p data-bbox="703 376 932 405"> <input type="checkbox"/> When set to Auto </p> <p data-bbox="751 421 1422 501">Adds the value selected for Margin (area of B in the following illustration) outside the hard clip area of the PS command of the data (area of A in the following illustration).</p> <div data-bbox="890 521 1385 1178" style="text-align: center;"> </div> <p data-bbox="703 1205 1198 1234"> <input type="checkbox"/> When set to a standard size or User Defined </p> <p data-bbox="751 1249 1422 1361">Adds the value selected for Margin (area of B in the following illustration) inside the size selected for Output Size (area of A in the following illustration) and prints only the section within the area excluding the margins.</p> <div data-bbox="906 1379 1369 2018" style="text-align: center;"> </div>

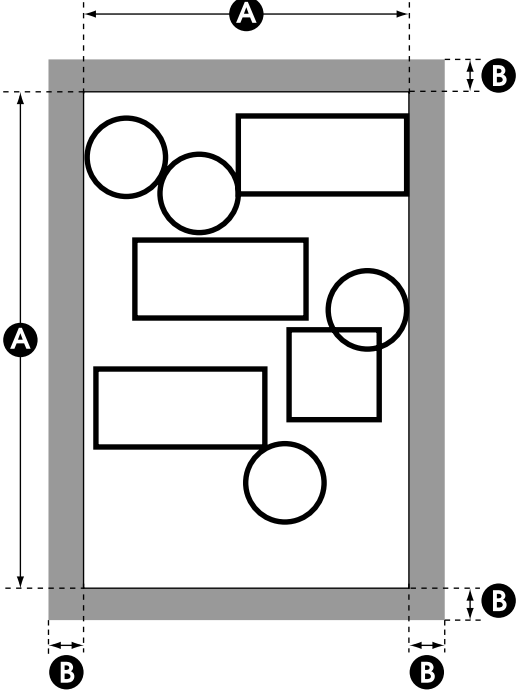

Using the Control Panel Menu

Item	Description
	<p data-bbox="475 300 608 327">Add Margins</p> <p data-bbox="703 300 1422 360">The position at which the margin is added depends on the Output Size setting, as shown below.</p> <ul style="list-style-type: none"> <li data-bbox="703 374 932 400">❑ When set to Auto <p data-bbox="751 416 1278 443">The result is the same as when Standard is selected.</p> <ul style="list-style-type: none"> <li data-bbox="703 459 1198 486">❑ When set to a standard size or User Defined <p data-bbox="751 501 1422 645">Adds the value selected for Margin (area of B in the following illustration) outside the size selected for Output Size (area of A in the following illustration). With the actual Output Size, the margin section becomes larger than the selected size (the area of A in the following illustration).</p> 

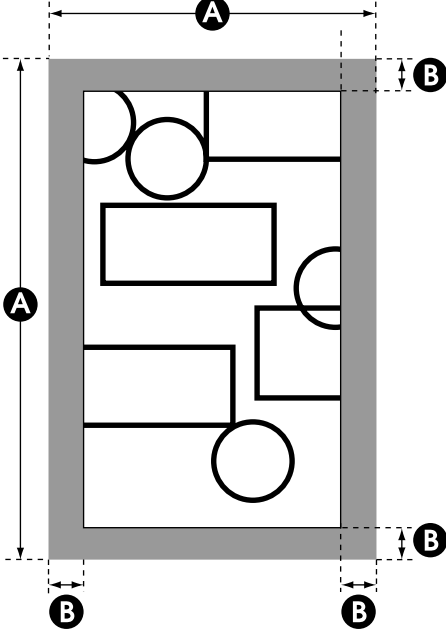
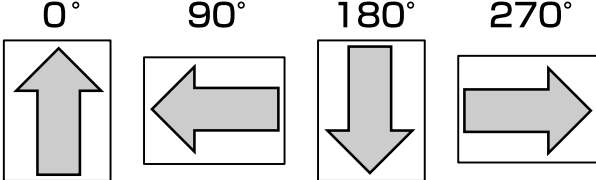
Using the Control Panel Menu

Item	Description					
	Clip By Margins	<p>Depending on the Output Size setting, adds the value selected for Margin (area of B in the following illustration) inside the hard clip area of the PS command of the data or the size selected for Output Size (area of A in the following illustration). When there is a print object in the margin section, it is clipped and not printed.</p> 				
Rotate	<table border="1"> <tr> <td data-bbox="470 1126 675 1171">0°*</td> </tr> <tr> <td data-bbox="470 1171 675 1227">90°</td> </tr> <tr> <td data-bbox="470 1227 675 1283">180°</td> </tr> <tr> <td data-bbox="470 1283 675 1608">270°</td> </tr> </table>	0°*	90°	180°	270°	<p>You can rotate the coordinates of the drawn data counterclockwise in units of 90° before printing. Note that objects drawn by RTL are not rotated.</p> <p>When both this setting and the RO command specify rotation, rotation is performed using the combined amount of both values. Note that rotation by the RO command is for objects only (the arrow section in the following illustration), and rotation is not performed for the drawn area (the square section in the following illustration). As a result, objects in a section that protrude from the drawn area are not printed.</p> 
0°*						
90°						
180°						
270°						

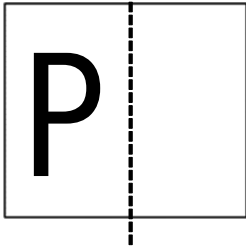
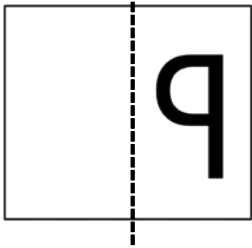
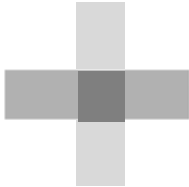
Using the Control Panel Menu

Item	Description	
Mirror	On	<p>Select whether to flip horizontally (mirror) using the center of the Output Size width as the basis line and then print (On) or print without flipping horizontally (Off).</p> <div style="display: flex; justify-content: space-around; align-items: center;"> <div style="text-align: center;"> <p>OFF</p>  </div> <div style="text-align: center;"> <p>ON</p>  </div> </div> <p>If an angle is specified for Rotate, the rotated result is flipped horizontally.</p>
	Off*	
Select Palette	Software*	<p>From the following selections, choose the palette that specifies the color and thickness of the logical pen.</p> <ul style="list-style-type: none"> <input type="checkbox"/> Software: Print according to the pen configurations set in the application, and ignore the built-in palette of the printer. <input type="checkbox"/> Default: Print according to the settings of the built-in palette of the printer specified in advance. The settings of the palette cannot be changed. The built-in palette specifies a logical pen with a pen width of 0.35 mm and 256 colors. For a sample of colors that correspond to the color numbers, see the included "Color Palette.pdf". <p>"Color Palette.pdf" recommends checking a print result that was printed with Print Quality set to CAD / Line Drawing (Color) in the included printer driver.</p> <ul style="list-style-type: none"> <input type="checkbox"/> Palette A/Palette B: The printer prints according to the settings of the built-in palette that you specified for Define Palette. If Define Palette setting is not set, the results are the same as when Default is selected. <p>When Default/Palette A/Palette B is set, the pen configurations set in the application are ignored.</p>
	Default	
	Palette A	
	Palette B	
Define Palette	Palette A*	<p>You can define a unique built-in palette by specifying the pen width and color for the 16 types of logical pen. There are two types of definable built-in palettes: Palette A and Palette B. Select a palette to be defined, select Pen Number, and then define the Pen Width and Pen Color for each pen. For a sample of colors that correspond to the color numbers, see the included "Color Palette.pdf".</p> <p>"Color Palette.pdf" recommends checking a print result that was printed with Print Quality set to CAD / Line Drawing (Color) in the included printer driver.</p>
	Palette B	
Line Merge	On	<p>Select whether to merge the intersection of the overlapping lines within the image according to the MC command of the data (On), or move lines to be printed later to the front at intersections (Off).</p> <div style="display: flex; justify-content: space-around; align-items: center;"> <div style="text-align: center;"> <p>On</p>  </div> <div style="text-align: center;"> <p>Off</p>  </div> </div>
	Off*	

Using the Control Panel Menu

Item	Description	
Save To HDD	Print And Save*	Set whether or not to save print jobs in the optional hard disk unit or Adobe PostScript 3 Expansion Unit.
	Print Only	By saving print jobs, you can print jobs directly from the hard disk and check the print job information and status. ☞ "Saving to and Reprinting on the Optional Hard Disk Unit" on page 69 If you select Print Only , print jobs are not saved.
Reset HP-GL/2 Settings	Yes	If Yes is selected, the HP-GL/2 Settings are restored to default values.
	No	

Restore Settings

Description	
Yes	If Yes is selected, the Printer Setup is restored to default values.
No	

Option Setup*4

PS3 Expansion Unit

Item	Description	
Version	The supported PostScript version and the latest version for processable PDF files are displayed. If the PDF version displayed in the document properties of the PDF file is the same or earlier than the version displayed here, the file can be processed.	
PS Status Sheet	If the OK button is pressed, the information of the Adobe PostScript 3 Expansion Unit is printed.	
Output Size	Auto	Select the size of the paper used for printing.
	A Series (A4*)/US-ANSI/ US-ARCH/B Series/Photo Series/Others	When Auto is selected, the printer prints using the size of the print data. The actual output size depends on the margin settings. When a standard size or User Defined is selected, all print data is enlarged or reduced to the selected paper size and then printed.
	User Defined	The sizes that can be selected vary with the printer model. When print data is created with the paper size set to A4, the following settings have the described results. Auto : data is printed with margins added outside the A4 size. A4 : data is printed with the A4 data reduced to the printable area of the A4 size.

Using the Control Panel Menu

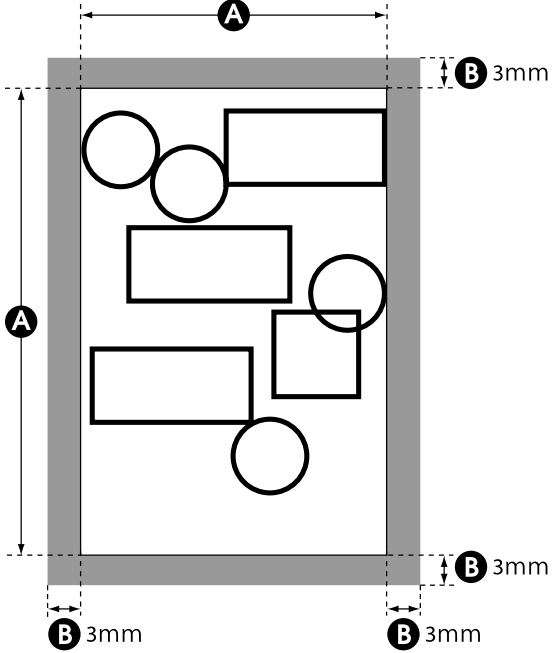
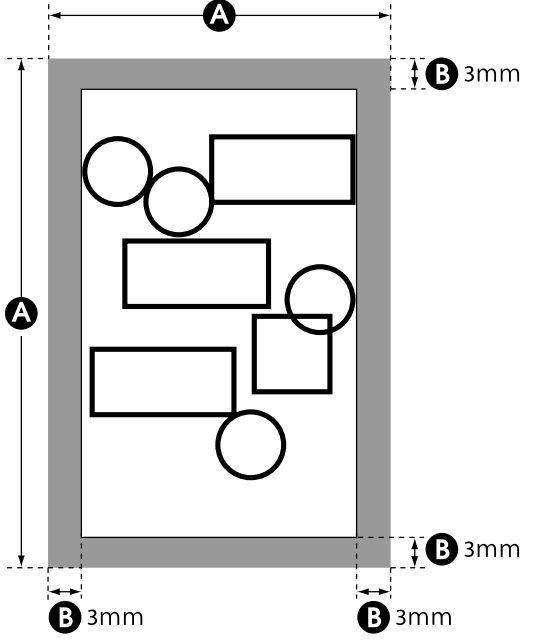
Item	Description	
Margin Options	Standard*	<p>The position at which the margin is added depends on the Output Size setting, as shown below.</p> <ul style="list-style-type: none"> <input type="checkbox"/> When set to Auto <p>Adds 3 mm of margin (area of B in the following illustration) outside the data size (paper size or image size; area of A in the following illustration).</p>  <input type="checkbox"/> When set to a standard size or User Defined <p>Adds 3 mm of margin (area of B in the following illustration) inside the size selected for Output Size (area of A in the following illustration) and enlarges or reduces size so that the data fits in the area excluding the margin before printing.</p> 

Using the Control Panel Menu

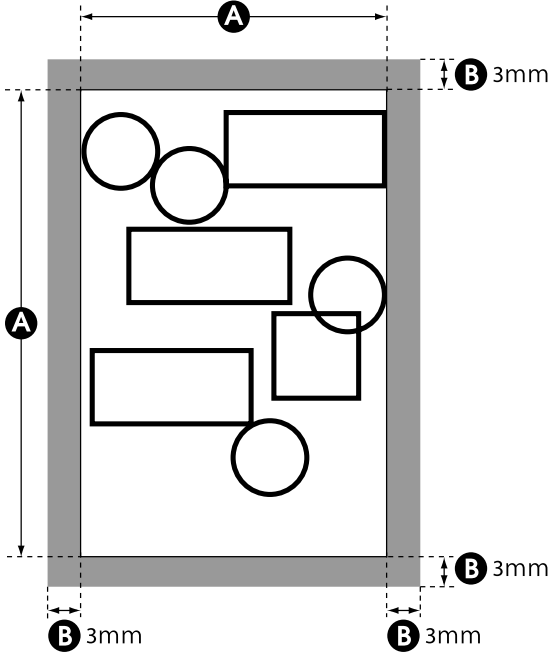
Item	Description	
	<p>Add Margins</p>	<p>The position at which the margin is added depends on the Output Size setting, as shown below.</p> <ul style="list-style-type: none"> ❑ When set to Auto The result is the same as when Standard is selected. ❑ When set to a standard size or User Defined Adds 3 mm of margin (area of B in the following illustration) outside the size selected for Output Size (area of A in the following illustration). Actual output size becomes larger than the selected size (area of A in the following illustration) due to addition of the margins. <p>When the created data size does not fit in the output size, data is reduced before printing.</p> 

Using the Control Panel Menu

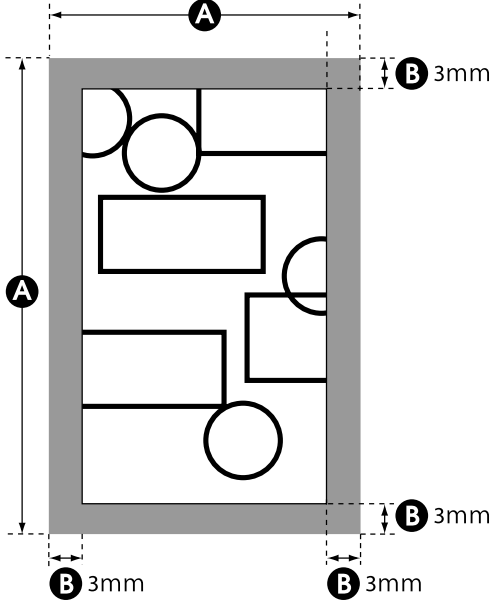
Item	Description	
	Clip By Margins	<p>Adds 3 mm of margin (area of B in the following illustration) inside the data size (paper size or image size) or the size selected for Output Size (area of A in the following illustration) depending on the Output Size setting. When there is a print object in the margin section, it is clipped and not printed.</p> <p>When the output size setting is configured to a standard size or user defined size and the created data size does not fit in the output size, data is printed with reduced size. However, when there is a print object in the margin section as a result of the reduction, it is clipped and not printed.</p> 
Quality	Speed Normal* Fine	Choose Print Quality in view of image quality and print speed.
Color Mode	Color* Grayscale	Specify whether to print in color or switch to black and white and then print. Depending on the paper type specified on the printer, the setting is not displayed. When you are using the SC-T7200D Series/SC-T5200D Series, the setting depends on the paper type of the roll paper currently in use.
Dot Correction	On Off*	<p>This setting is displayed only when the paper type is set to Singleweight Matte Paper and Plain Paper.</p> <p>When you are using the SC-T7200D Series/SC-T5200D Series, the setting depends on the paper type of the roll paper currently in use.</p> <p>If lines printed with CAD programs or similar programs have gaps or smudges, you may be able to reduce them by setting On.</p>

Using the Control Panel Menu

Item	Description	
CMYK Simulation	<p>SWOP v2/US Web Uncoated v2/US Sheetfed Coated v2/US Sheetfed Uncoatedv2/Coated GRACoL 2006/SWOP Grade 3 Paper/SWOP Grade 5 Paper/Coated FOGRA27/Web Coated FOGRA28/Uncoated FOGRA29/Coated FOGRA39/Euroscale Coated v2*/Euroscale Uncoated v2/JapanWebCoated (Ad)/JapanColor2001Coated/JapanColor2001Uncoated/JapanColor2002Newspape/JapanColor2003WebCoate/EPSON_TOYO/EPSON_DIC/Off</p> <p>When you simulate CMYK ink colors of offset printers, you can select the color of the CMYK ink to be simulated.</p> <p>If Off is set, ink is not simulated.</p>	
RGB Source	<ul style="list-style-type: none"> sRGB Adobe RGB (1998)* Apple RGB ColorMatch RGB Off 	<p>When you will print RGB data, you can select the color space of the RGB to be simulated.</p> <p>If Off is set, ink is not simulated.</p>
Rendering Intent	<ul style="list-style-type: none"> Absolute Relative Perceptual* Saturation 	<p>Select the conversion method (rendering intent) of color space when carrying out CMYK simulation or RGB simulation from the following four types.</p> <ul style="list-style-type: none"> <input type="checkbox"/> Absolute Colorimetric: Assigns absolute color gamut coordinates to the original and print data and converts the data. Color tone adjustment is not performed on any white point (or color temperature) for the original or print data. This setting is appropriate for when color accuracy is important, such as when printing logo colors. <input type="checkbox"/> Relative Colorimetric: Converts the data so that a set of color gamut and white point (or color temperature) coordinates in the original data match their corresponding print coordinates. This feature is used for many types of color matching. <input type="checkbox"/> Perceptual: Converts the data so that a more visually natural image is produced. This setting is appropriate for photo images. <input type="checkbox"/> Saturation: Convert focusing on the vividness of color rather than color accuracy. Suitable for business graphics such as graphs and charts, for which the use of bright colors is preferred.
Black Pt Compensation	<ul style="list-style-type: none"> On Off* 	<p>When you have converted from a wide color space to narrow color space or you feel that the shadows are smudged, set to On.</p>
Auto Rotate	<ul style="list-style-type: none"> On Off* 	<p>Select whether to rotate portrait print data 90° to the right automatically (On) or print without rotation (Off).</p>
Caching To HDD	<ul style="list-style-type: none"> On Off* 	<p>Normally, leave the setting at Off. If the print head stops frequently while waiting for data expansion during printing, set to On.</p>
PS Error Sheet	<ul style="list-style-type: none"> On Off* 	<p>Select whether to print a sheet with the error condition listed (On) or not to print (Off) when a PostScript error occurs during printing or an error occurs during printing of a PDF file.</p>

Using the Control Panel Menu

Item	Description	
Save To HDD	Print And Save*	Set whether or not to save print jobs in the optional hard disk unit or Adobe PostScript 3 Expansion Unit.
	Print Only	By saving print jobs, you can print jobs directly from the hard disk and check the print job information and status. 📄 "Saving to and Reprinting on the Optional Hard Disk Unit" on page 69 If you select Print Only , print jobs are not saved.

Printer Status

Item	Description	
Firmware Version	xxxxxxx,x.xx,xxxx	You can see the firmware version. When an optional auto take-up reel unit is connected, its firmware version is displayed below the firmware version of the printer. Furthermore, when an optional Adobe PostScript 3 Expansion Unit is connected, its two control versions are displayed at the end.
Option Status	Lists the optional accessories currently connected to the printer and available for use.	
Show Total Prints	XXXXXX m ²	Displays the total area of media printed (to a maximum of six digits).
Print Status Sheet	Press the OK button to print a list of current printer settings. Choose this option to view settings at a glance.	

Network Setup

Item	Description	
IP Address Setting	Auto*	Select whether to use DHCP to set the IP address (Auto), or to set the address manually (Panel). Set the IP address , Subnet Mask , and Default Gateway on the Panel . Contact your system administrator for detailed information.
	Panel	
IPv6 Setting	Enable	Select whether to enable or disable the IPv6 function.
	Disable*	
IPsec Setting	Enable	Select whether to enable or disable the IPsec function.
	Disable*	
PSK Setting	Enter a Pre-Shared Key of up to 20 characters (half-width alphanumeric characters and symbols).	
IEEE802.1x Setting	Enable	Select whether to enable or disable the IEEE802.1X function.
	Disable*	
HTTPS Redirect Setting	Enable	Select whether to enable or disable the function to auto-direct HTTP to HTTPS.
	Disable*	

Using the Control Panel Menu

Item	Description	
Print Status Sheet	Press the OK button to print a list of the Network Setup . Use this information for a complete overview of network settings.	
Restore Settings	Yes	Select Yes to restore all Network Setup content to default values.
	No	

Power Settings

Item	Description	
Sleep Mode	5 to 210 minutes (15*)	The printer will enter sleep mode if no errors have occurred, no print jobs have been received, and no actions are performed on the control panel for an extended period of time. This setting selects the amount of time until the printer enters sleep mode. ☞ "Turning Off the Power Using Power Off Timer" on page 67
Power Off Timer	Off	The printer turns off automatically when there are no errors, no print jobs being received, and no control panel or other operations are performed for eight hours. The delay before the printer turns off can be selected from values between 1 and 24 hours in increments of 1 hour. Choose Off to prevent the printer turning off automatically.
	1 to 24 hours (8*)	
Restore Settings	Yes	Select Yes to restore all Eco Settings to default values.
	No	

Preference

Item	Description	
Language	Japanese, English, French, Italian, German, Portuguese, Spanish, Dutch, Russian, Korean, Chinese	Select the language used on the control panel's screen.
Unit: Length	m*	Select the unit of length which is displayed on the control panel's screen or printed on the patterns.
	ft/in	
Alert Lamp Setting	On*	Choose whether the large alert lamp lights (On) or does not light (Off) when an error occurs.
	Off	

Using the Control Panel Menu

Administrator Menu

Item		Description	
Change Password		<p>Enter an administrator password of up to 20 characters.</p> <p>Selecting Administrator Menu displays a password prompt. The Administrator Menu will only be displayed if the correct password is entered, preventing non-administrators from accidentally changing settings.</p> <p>Keep the password in a safe place.</p> <p>Should you forget the password, contact your dealer or Epson Support.</p>	
Operational Control	Network Setup	Password Required	Choose whether the administrator password is required to access Network Setup from the control panel or Remote Manager.
		No Password Required*	
Power Cleaning		 <p>Inspect the printed pattern and select the check boxes for patterns with faint or missing areas. To select all nozzles, place a check in the box on the left.</p>	
Format HDD ^{*3}	Non-Secure (Quick)	A confirmation message is displayed, if you approve, the optional hard disk unit or Adobe PostScript 3 Expansion Unit (hereinafter referred to as the hard disk) that is installed on the printer is formatted.	
	Secure (Quick)	You can select from the three types of formatting.	
	Secure (Sanitizing)	<ul style="list-style-type: none"> <input type="checkbox"/> Non-Secure (Quick): The file control information for the data saved on the hard disk is deleted. This is also done when using a hard disk that was used in a different printer as a replacement in your printer. <input type="checkbox"/> Secure (Quick): The entire hard disk is overwritten with a random strings. The data is deleted more securely than with Non-Secure (Quick). However, it may be possible to recover the data by using special data retrieval tools. <input type="checkbox"/> Secure (Sanitizing): The disk is overwritten with 00/FF/random data by using an algorithm that is compliant with the US Department of Defense (DoD 5220-22m). This takes the most time for the formatting to finish, but the data is the most securely deleted. Select this to delete highly confidential data. <p>If Secure (Quick) or Secure (Sanitizing) is performed, all address book content registered by Copy Manager is deleted.</p>	
Printer Mode	Auto*	Normally, leave the setting at Auto . Sent print data is identified, and the operation mode is switched automatically. If operation mode switching is not performed correctly, and printing is not performed correctly, set to the operation mode to be used.	
	PostScript ^{*4}		
	HP-GL/2		
Date And Time		MM/DD/YY HH:MM	Set the printer's built-in clock. The time provided by the clock is used when printing logs and status sheets.

Using the Control Panel Menu

Item	Description	
Time Zone	Enter the difference between the current time zone and GMT. The selected time zone is used in e-mail notifications sent by Remote Manager when an error occurs and so on.	
Reset PS Settings*4	Yes	Select Yes to initialize the user font and user ICC profile saved in the user area of the Adobe PostScript 3 Expansion Unit. Initialization deletes saved data.
	No	
Reset All Settings	Yes	Select Yes to restore defaults for all settings except the Date And Time, Language, and Unit: Length options in the Setup menu. All address book content registered by Copy Manager is deleted.
	No	

Using the Control Panel Menu

Enlarged Copy menu

The Enlarged Copy menu is displayed only when a A3 or A4 scanner is connected.

Supported scanners are listed on the Epson website.

<https://www.epson.com>

* Default setting

Item		Description		
Color/Grayscale		Color*	Choose whether to do enlarged copying in color or in grayscale.	
		Grayscale		
Auto	A3->Auto, B4->Auto, A4->Auto, B5->Auto, A5->Auto, LTR->Auto, 4x6->Auto, A4/2->Banner(Auto)		With Border*	Document sizes are listed to the left of the arrows. The copy is enlarged to fit the width of the roll currently loaded in the printer. The maximum size is 914 mm (36 inches). If a roll wider than 36 inches is loaded in the SC-T7200 Series/SC-T7200D Series, the maximum size is still 36 inches. To print without borders, select Borderless . Note that this item is not displayed when a plain paper roll is loaded because Borderless is not supported. The sizes available vary with the scanner.
			Borderless	
	Other Size	Document Size	A3, B4, A4*, B5, A5, LTR, 4x6	Select the size of the original document when copying at other sizes. The sizes available vary with the scanner.
		Output Size	A0, USE, B1, A1*, US D, B2, US C, A2, A0(2Sheets)	Choose the output size when copying at other sizes. A0(2Sheets) is available only with the SC-T3200 Series. A0 is available only with the SC-T7200 Series/SC-T7200D Series/SC-T5200 Series/SC-T5200D Series.
		Border	With Border*	To print without borders, select Borderless . This item is not displayed when a plain paper roll is loaded because Borderless is not supported.
	Borderless			
Quality		Speed	Choose Copy Quality in view of image quality and print speed.	
		Fine		
Density		Five options from Light to Dark	Choose copy density.	

Using the Control Panel Menu

Large Copy / Large Scan menu

This menu is displayed only when the optional MFP Scanner is connected.

 [“Large Copying and Large Scanning using the MFP Scanner \(Option\)” on page 73](#)

*1: SC-T7200D Series/SC-T5200D Series only

*2: SC-T7200 Series/SC-T5200 Series

*3: Displayed when the optional hard disk unit or Adobe PostScript 3 Expansion Unit is installed

*4: Displayed when Adobe PostScript 3 Expansion Unit is installed

* Default setting

Copy Settings

Item		Description	
Source		Roll Paper (or Roll 1 ^{*1}) *	Select the paper source for copying. If you select Roll Auto , the roll of paper that leaves the smallest margins is automatically selected, and then printing is done.
		Roll 2 ^{*1}	
		Roll Auto ^{*1}	
		Cut sheet	
Scaling	Manual*	25 to 400% (100*)	Choose whether to set the copy scaling manually (Manual) or zoom automatically in accordance with the width of the loaded roll paper (Auto).
	Auto		
Color/Grayscale		Color*	Select whether to print color documents in color or in grayscale.
		Grayscale	
Document type		Text/Line Drawing*	Select the type in accordance with the loaded document.
		Tracing Paper	
		Recycled Paper	
		Blueprint	
		Blueprint Inverted	
		Poster	
Width	Auto*		The default setting of Auto is recommended in most situations. Note that, depending on the document, it may not be possible to detect the width correctly even when the setting is Auto . In such cases, change from the standard size and specify a width of your choosing.
	ISO A, US-ANSI, US-ARCH, JIS B, ISO B	The supported sizes are displayed.	
	cm	20 to 90cm (20*)	
	inch	8 to 36in (8*)	

Using the Control Panel Menu

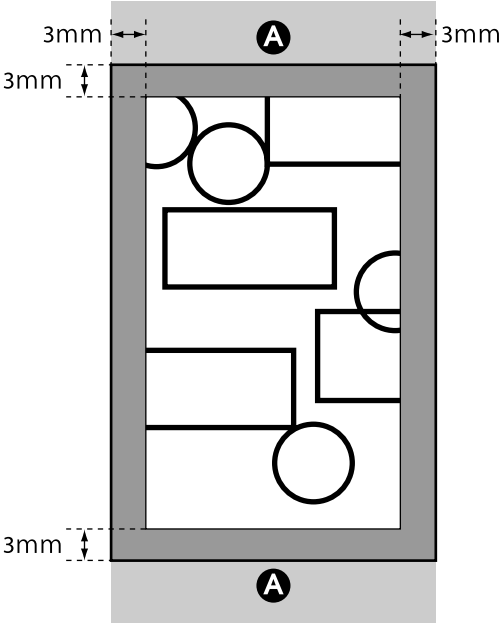
Item	Description	
Quality	Speed*	Choose the quality of copying.
	Fine	<p>Fine prioritizes quality so the print speed is slower.</p> <p>This item may default to Fine depending on the type of media used.</p>
Margin Options	Clip By Margins*	<p>A 3-mm margin is added to the inside of the scanned area on all four sides and then the document is printed. (refer to the following illustration)</p> <p>If part of the image is in the margin, it is not printed.</p> <p>If a value other than 3 mm is set for the Roll Paper Margin, a margin of that value, excluding the 3 mm from the other values, is added to top and bottom of the scanned area.</p> <p>For example, if Top15mm/Bottom15mm is set, a margin of 12 mm is set in A as shown in the illustration below.</p> 

Using the Control Panel Menu

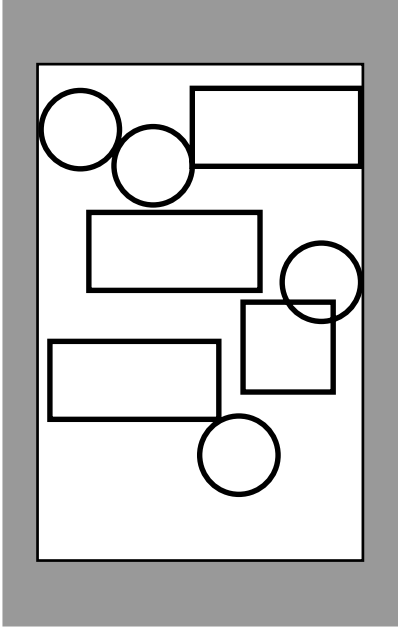
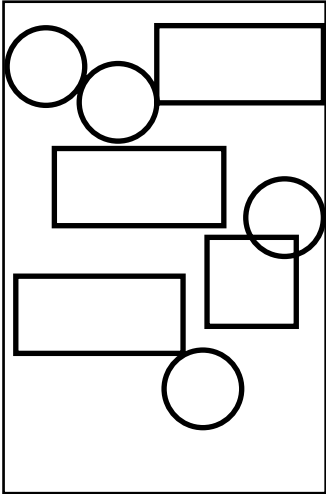
Item	Description	
	<p>Add Margins</p>	<p>The margin set in Roll Paper Margin is added to the outside of the scanned area and then the document is printed. (refer to the following illustration)</p> 
	<p>Borderless</p>	<p>The scanned area is printed as is. (refer to the following illustration)</p> <p>The Roll Paper Margin setting is disabled.</p> 
<p>Density</p>	<p>Level -3 to 3 (0*)</p>	<p>Set the copy density. Negative values (-) are lighter, and positive values (+) is darker.</p>
<p>Contrast</p>	<p>Level -3 to 3 (0*)</p>	<p>Set the contrast. Negative values (-) are weaker, and positive values (+) are stronger.</p>
<p>Background</p>	<p>Level -3 to 3 (0*)</p>	<p>Set the adjustment value for the background. Configure this setting when you are copying documents with colors or documents that are thin, or when removing unwanted backgrounds. Negative values (-) are weaker, and positive values (+) are stronger.</p>

Using the Control Panel Menu

Item	Description	
Sharpness	Level -3 to 3 (0*)	Set the sharpness. Negative values (-) are weaker, and positive values (+) are stronger.

Scan Setting*3

Item	Description		
Color/Grayscale	Color*	Choose whether to scan colored documents in color, or to change settings to scan in grayscale or black and white.	
	Grayscale		
	B&W		
Document type	Text/Line Drawing*	Select the type in accordance with the loaded document.	
	Tracing Paper		
	Recycled Paper		
	Blueprint		
	Blueprint Inverted		
	Poster		
Width	Auto*	The default setting of Auto is recommended in most situations. Note that, depending on the document, it may not be possible to detect the width correctly even when the setting is Auto . In such cases, change from the standard size and specify a width of your choosing.	
	ISO A, US-ANSI, US-ARCH, JIS B, ISO B		The supported sizes are displayed.
	cm		20 to 90cm (20*)
	inch		8 to 36in (8*)
Save Image type	JPEG*	Select the file format for scanned images.	
	PDF		
	TIFF		
Resolution	100dpi	Choose the resolution for scanning.	
	200dpi		
	300dpi		
	360dpi*		
	400dpi		
	600dpi		
File Size Compression	High	Choose the compression rate when saving scanned images.	
	Standard*		
	Low		

Using the Control Panel Menu

Item	Description	
Density	Level -3 to 3 (0 [*])	Choose the density for scanning. Negative values (-) are lighter, and positive values (+) is darker.
Contrast	Level -3 to 3 (0 [*])	Set the contrast. Negative values (-) are weaker, and positive values (+) are stronger.
Background	Level -3 to 3 (0 [*])	Set the adjustment value for the background. Configure this setting when you are scanning documents with colors or documents that are thin, or when removing unwanted backgrounds. Negative values (-) are weaker, and positive values (+) are stronger.
Sharpness	Level -3 to 3 (0 [*])	Set the sharpness. Negative values (-) are weaker, and positive values (+) are stronger.

Maintenance

Maintenance

Adjusting the Print Head

You need to adjust the print head if white lines appear in your print outs or if you notice the print quality has declined. You can perform the following printer maintenance functions for maintaining the print head in good condition to ensure the best print quality.

Carry out appropriate maintenance depending on the print results and situation.

Checking for clogged nozzles

Perform a nozzle check to check for clogs if the printer has not been used for an extended period or before important print jobs. Visually inspect the printed check pattern and clean the print head if you notice faint or missing areas.

Cleaning the print head

Clean the print head if you notice faint or missing areas in printed documents. Cleans the surface of the print head to improve the print quality. Choose normal or power cleaning according to the level of cleaning required.

[“Cleaning the print head” on page 180](#)

Normal cleaning is recommended in most circumstances. Use power cleaning if the nozzles remain clogged after normal cleaning has been performed several times.

Adjusting the print head position (Print Head Alignment)

Perform Head Alignment if lines are misaligned or print results are grainy. The Head Alignment function corrects print misalignments.

[“Aligning print position misalignment \(Head Alignment\)” on page 181](#)

Checking for clogged nozzles

Nozzle checks can be performing from a computer or using printer's control panel.

From the computer

Explanations in this section use the Windows printer driver as an example.

Use **Epson Printer Utility 4** for Mac OS X.

[“Epson Printer Utility 4 Functions” on page 133](#)

- 1 Make sure that the roll paper or a cut sheet of A4 size or larger is loaded in the printer.

Make sure you set the paper source and media type correctly according to the paper you use.

- 2 Click **Nozzle Check** from the **Utility** tab in the printer driver's **Properties** (or **Printing preferences**) screen.

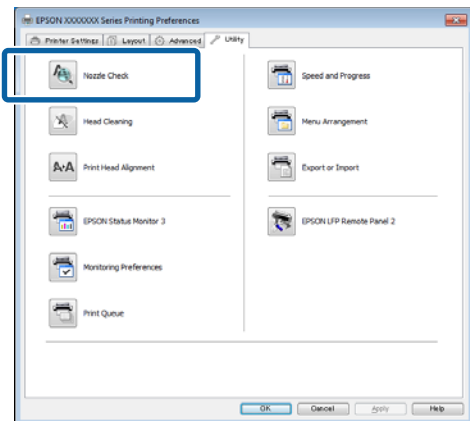

- 3 Click **Print**.

The nozzle check pattern is printed.

- 4 Check the nozzle check pattern.

If there is no problem: click **Finish**.

If there is a problem: click **Clean**.

After printing a nozzle check pattern, make sure that the nozzle check pattern printing is complete before printing your data or cleaning the print head.

Maintenance

From the printer

Buttons that are used in the following settings

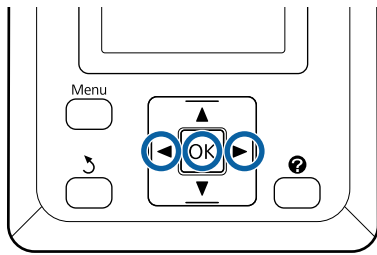

- 1 Make sure that the roll paper or a cut sheet of A4 size or larger is loaded in the printer.

Make sure you set the paper source and media type correctly according to the paper you use.

- 2 Confirm that the printer is ready to print. Press the **A▶A** button.

The Maintenance menu will be displayed.

- 3 Confirm that **Nozzle Check** is highlighted and press the OK button.

A confirmation dialog will be displayed.

- 4 Press the OK button to print a check pattern.

Review the printed check pattern while referring to the following section.

Example of clean nozzles

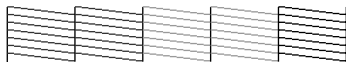

There are no gaps in the nozzle check pattern.

Example of clogged nozzles

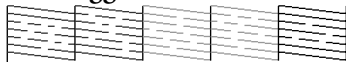

If there are areas missing from the pattern, select **Head Cleaning** and clean the print head. 
[“Cleaning the print head” on page 180](#)

Cleaning the print head

Although head cleaning can be performed from the computer or the printer, the cleaning procedures differ as explained below.

- From the computer

All nozzles are cleaned.

- From the printer

You can clean all nozzles or select for cleaning only those nozzles for which the printed nozzle check pattern indicates a problem.

Notes on head cleaning

Note the following points when performing head cleaning.

- Clean the print head only if print quality declines; for example, if the printout is blurry or the color is incorrect or missing. Ink is consumed when head cleaning is performed.
- Cleaning all nozzles consumes some of each color of ink. Even if you are using only black inks for black and white printing, color inks are also consumed.
- When repeating head cleaning in a short time period, the Maintenance Box may fill up quickly due to a small amount of ink evaporation in the Maintenance Box. Prepare a spare Maintenance Box if there is not enough empty space in the box.
- If the nozzles are still clogged after cleaning the print head several times, we recommend trying power cleaning.
- Power cleaning consumes more ink than normal head cleaning. Check the remaining ink level in advance, and prepare a new ink cartridge before you start cleaning if the ink is low.
- If the nozzles are still clogged after performing power cleaning, turn off the printer and leave it overnight or longer. When left for some time, the clogged ink may dissolve.

If the nozzles are still clogged, contact your dealer or Epson Support.

Head Cleaning

From the computer

Explanations in this section use the Windows printer driver as an example.

Use **Epson Printer Utility 4** for Mac OS X.

Maintenance

[“Using Epson Printer Utility 4” on page 133](#)

- 1 Click **Head Cleaning** from the **Utility** tab in the printer driver's **Properties** (or **Printing preferences**) screen.

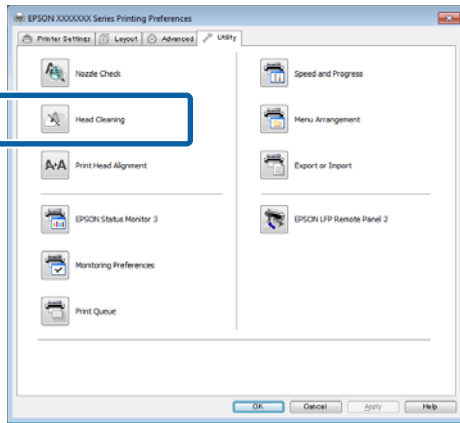

- 2 Click **Start**.
Head cleaning starts and it takes about one to ten minutes.
- 3 Click **Print Nozzle Check Pattern**.
Confirm the nozzle check pattern.

If any segments are missing in the nozzle check pattern, click **Clean**.

From the printer

Buttons that are used in the following settings

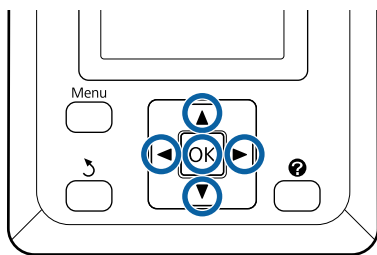

- 1 Confirm that the printer is ready to print. Press the **A>A** button.

The Maintenance menu will be displayed.
- 2 Press the **▼/▲** buttons to highlight **Head Cleaning** and press the **OK** button.

You will be prompted to choose nozzle rows.

- 3 Select nozzle rows for cleaning.

Press the **◀/▶** buttons to highlight numbers corresponding to check patterns with faint or missing segments and press the **▼/▲** button to select.

You can select multiple nozzle rows.

To select all nozzles, place a check in the box on the left.

- 4 Pressing the **OK** button displays a confirmation message. Press the **OK** button to start head cleaning.

A confirmation message is displayed when cleaning is complete.

- 5 To print a check pattern and check the status of the clog, press the **▼/▲** buttons to highlight **Nozzle Check** and press the **OK** button.

To exit without performing a nozzle check, highlight **Exit** and press the **OK** button.

Aligning print position misalignment (Head Alignment)

If ruled lines are misaligned or graininess is conspicuous in the print results, perform Head Alignment to align the misalignment of the print position.

This printer drops ink drops while moving the print head. There is a small distance (gap) between the paper surface and print head, and paper thickness, temperature and humidity changes, inertia of a moving print head, and other factors cause misalignment of the ink-drop arrival position (print position).

Head Alignment can be performed from the computer or the printer, and the procedures differ as explained below.

From the computer

Perform Auto alignment (Bi-D). The sensor reads the alignment pattern as it is printed to the loaded paper and registers the optimum alignment value to the printer. Alignment takes about 30 minutes to complete.

[“From the computer” on page 183](#)

Maintenance

We normally recommend this method as it eliminates most problems and is simple to perform. However, manual head alignment can be performed from the printer's control panel if you are using cut sheets or other paper that does not support auto head alignment or if auto alignment does not fix the problem completely.

From the printer

Auto and Manual can be chosen for alignment. Choose Manual if auto alignment does not completely fix the problem.

Auto alignment

Auto(Bi-D) and Auto(Uni-D) head alignment are available for auto alignment. With Auto(Bi-D), alignment can be performed in the same manner as auto alignment from a computer. Both alignment methods take about 30 minutes to complete.

When auto alignment is performed, alignment is performed using **Auto(Bi-D)** first.

When head alignment as already been performed from a computer or when the alignment results were unsatisfactory with **Auto(Bi-D)**, perform **Auto(Uni-D)**. When the alignment results with **Auto(Uni-D)** were unsatisfactory, perform **Manual(Bi-D)**.

Manual alignment

Use manual alignment with cut sheets or other paper that does not support automatic head alignment or if auto alignment does not fix the problem completely.

Inspect the pattern printed to the paper visually, and then enter the value you think appropriate. Printing the pattern takes from 4 to 11 minutes. The time required depends on the width of the loaded paper.

When **Manual(Bi-D)** is performed first, and the alignment results are unsatisfactory, perform **Manual(Uni-D)**.

 [“From the printer” on page 183](#)

Head Alignment considerations

Alignment is performed in accordance with the paper loaded in the printer.

Load the paper for which head alignment is required correctly, and always perform **Select Paper Type**.

The minimum paper size for alignment is A4.

 [“Loading and Removing the Roll Paper” on page 29](#)

 [“Loading and Removing Cut Sheets” on page 39](#)

Use the Custom Paper Setting in advance when aligning with commercially available paper.

 [“Before printing on non-Epson media” on page 222](#)

Make sure the nozzles are not clogged first.

If nozzles are clogged, alignment is not performed correctly. Print a check pattern, check it visually, and then perform Head Cleaning if necessary.

 [“Checking for clogged nozzles” on page 179](#)

Automatic alignment cannot be performed on some paper.

Some commercially available paper may not be suitable for automatic alignment. Refer to the following for Epson special media that is not suitable for automatic alignment.

 [“Epson Special Media Table” on page 212](#)

If you are using paper for which automatic alignment cannot be used, perform manual alignment.

 [“From the printer” on page 183](#)

When performing automatic alignment, make sure that external light (direct sunlight, etc.) does not enter the printer.

The sensor of the printer may not read the alignment pattern correctly. If automatic alignment cannot be performed even when light is not entering this printer, perform manual alignment.

 [“From the printer” on page 183](#)

Maintenance

From the computer

Always read the following before alignment.

[“Head Alignment considerations” on page 182](#)

Explanations in this section use Windows as an example.

Use Epson Printer Utility 4 for Mac OS X.

[“Using Epson Printer Utility 4” on page 133](#)

1 Load roll paper in the printer.

Configure a paper type that matches the paper in the printer.

[“Loading and Removing the Roll Paper” on page 29](#)

[“Viewing and Changing Media Settings” on page 45](#)

Use the Custom Paper Setting in advance when aligning with commercially available paper.

[“Before printing on non-Epson media” on page 222](#)

2 Open the printer driver's **Properties** (or **Printing preferences**) screen, select the **Utility** tab, and then click **Print Head Alignment**.

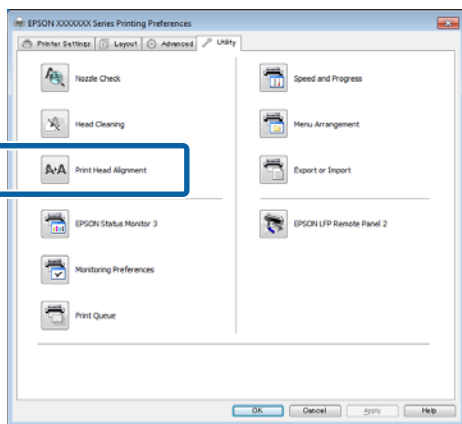

Follow the on-screen instructions to align the print head.

The sensor reads the alignment pattern as it is printed and automatically registers the optimum alignment value to the printer.

Print images that had noticeable graininess or misalignments again, and then check the alignment results.

When the alignment results are unsatisfactory, perform **Auto(Uni-D)** or Manual alignment from the printer.

[“From the printer” on page 183](#)

From the printer

Always read the following before alignment.

[“Head Alignment considerations” on page 182](#)

Buttons that are used in the following configurations

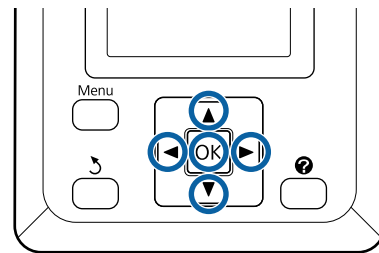

1 Load the paper for which head alignment is required correctly, and always perform **Select Paper Type**.

[“Loading and Removing the Roll Paper” on page 29](#)

[“Loading and Removing Cut Sheets” on page 39](#)

[“Viewing and Changing Media Settings” on page 45](#)

Use the Custom Paper Setting in advance when aligning with commercially available paper.

[“Before printing on non-Epson media” on page 222](#)

Maintenance

2 Confirm that the printer is ready to print. Press the ◀/▶ buttons, select  and press the OK button.

The Maintenance menu is displayed.

3 Use the ▼/▲ buttons to select **Head Alignment** and press the OK button.

4 Select the target alignment item and press the OK button.

If **Auto** alignment is selected, the printer automatically aligns the head as it prints the head alignment pattern. When alignment is finished, the printable screen returns.

If **Manual** alignment is selected, proceed to Step 5 to enter alignment value based on a visual inspection of the pattern.

5 The alignment pattern is printed.

Manual(Bi-D)

An alignment pattern block is two or four colors by three rows, and one to five blocks are printed horizontally in accordance with the loaded paper width. A color symbol is printed on the pattern of each color.

The four blocks printed in the vertical direction are labeled “#1” through “#4”.

Manual(Uni-D)

An alignment pattern block is three colors by three rows, and one to five blocks are printed horizontally in accordance with the loaded paper width. A color symbol is printed on the pattern of each color.

The four blocks printed in the vertical direction are labeled “#1” through “#4”.

Manual(Uni-D) example

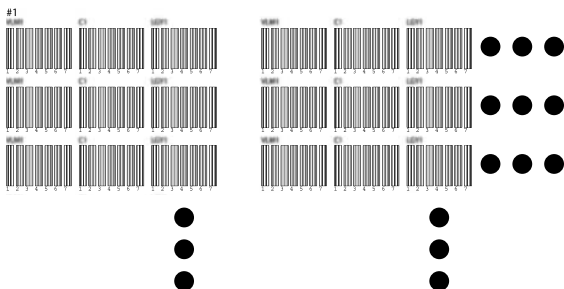

6 Note the number of the pattern with the fewest white lines or in which the white lines are most evenly spaced for each color pattern.

This would be Pattern 3 in the following illustration.

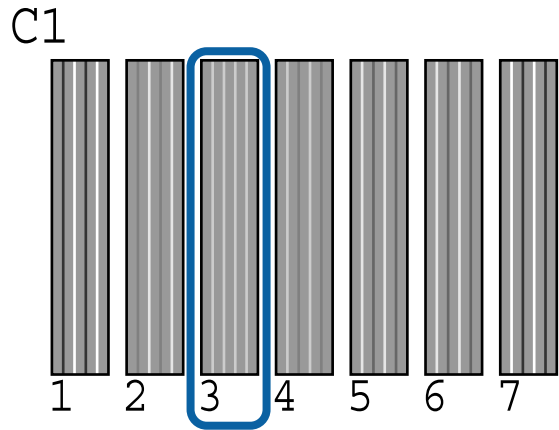

7 For each color, calculate the average value of numbers of the results that confirmed the pattern of the same color for each row.

Example) When an alignment pattern is printed in two blocks in the horizontal direction, and the confirmation result of the pattern of C1 of the first row is as follows

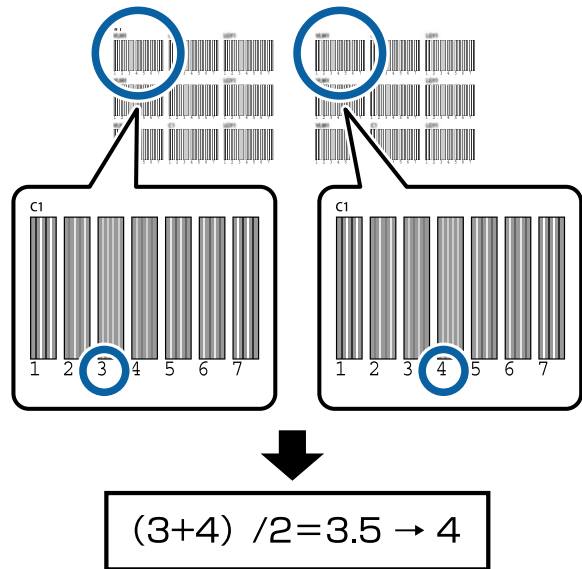

When the calculated value is not an integer, round off to the nearest integer.

In this way, the average value of the number of the confirmation result of each color by each row is calculated.

Maintenance

8 After confirming the ink color symbol displayed in the control panel's screen, press the ▼/▲ buttons to set the average value calculated in Step 7 and press the OK button.

9 Set numbers for all colors and press the OK button.

The Maintenance menu is displayed once the last number has been entered.

Replacing Consumables

Replacing Ink Cartridges

If the amount of ink remaining is at or below the limit value even for one color on any of the installed ink cartridges, printing cannot be performed.

If the amount of remaining ink reaches or falls below the limit value during printing, you can continue printing after replacing the ink cartridge.

If you continue to use an ink cartridge with a low amount of ink remaining, it may be necessary to replace the ink cartridge during printing. If ink is replaced during a print job, you may see a difference in color depending on the drying conditions. When this is not permissible, we recommend exchanging the ink cartridge with a new one before printing. You can load the removed ink cartridge again and use it until the amount of ink remaining reaches or falls below the limit value.

Use the following procedure to replace an ink cartridge.

How to replace

You can use the same procedure to replace all ink cartridges.



Important:

Epson recommends the use of genuine Epson ink cartridges. Epson cannot guarantee the quality or reliability of non-genuine ink. The use of non-genuine ink may cause damage that is not covered by Epson's warranties, and under certain circumstances, may cause erratic printer behavior. Information about non-genuine ink levels may not be displayed, and use of non-genuine ink is recorded for possible use in service support.

1

Make sure the printer is on.

Maintenance

- 2** Open the cartridge cover.

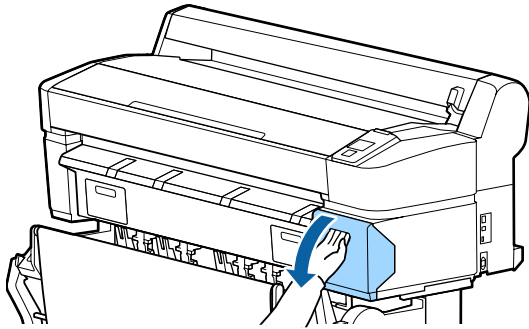

- 3** Hook a finger into the indentation on the top of the cartridge and pull it straight toward you.

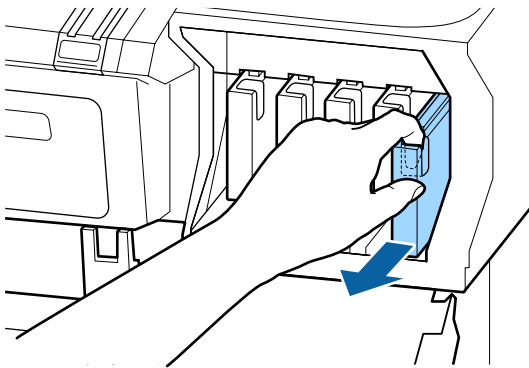

! Important:
Removed ink cartridges may have ink around the ink supply port, so be careful not to get any ink on the surrounding area when removing the cartridges.

- 4** Remove the new ink cartridge from the bag. Shake the ink cartridge for 10 seconds 30 times horizontally in approximately 5 cm movements as shown in the illustration.

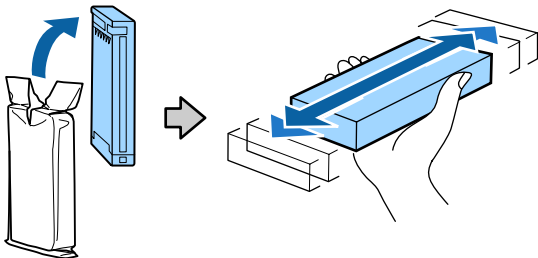

! Important:
Do not touch the IC chips on the ink cartridges. You may not be able to print properly.

- 5** Holding the cartridge with the label out, slide it all the way into the slot.

Match the color of the cartridge to the color of the label on the printer.

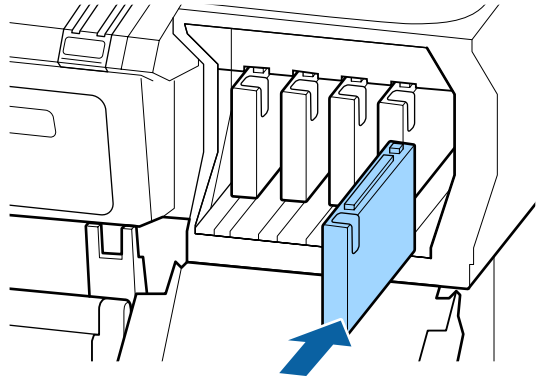

Repeat Steps 3 to 5 to replace other ink cartridges.

! Important:
Install all ink cartridges into each slot. You cannot print if any of the slots are empty.

- 6** Close the cartridge cover.

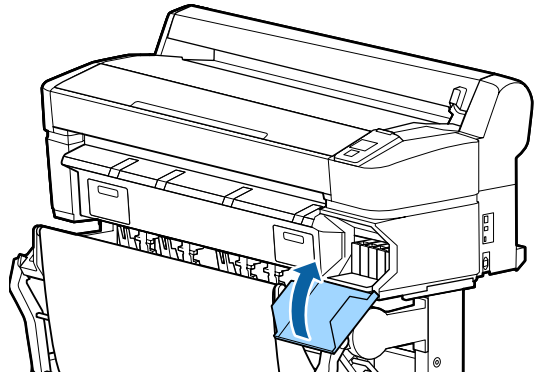

! Important:
We recommend that you remove and shake the installed ink cartridges once every three months to ensure print quality.

Replacing Maintenance Boxes

If the message **No Enough Space** is displayed, replace the specified Maintenance Box.

Supported Maintenance Boxes

Maintenance

 [“Options and Consumable Products” on page 210](#)

! **Important:**

Do not reuse maintenance boxes that have been removed and left out in the open for a long period of time. The ink on the inside will be dry and hard and will be unable to absorb enough ink.

How to replace

Some models of printer have Maintenance Boxes on both the left and right sides, but the procedure for replacing the boxes is the same in all cases.

! **Important:**

Do not replace Maintenance Box while printing. Waste ink may leak.

- 1 Open the maintenance box cover.

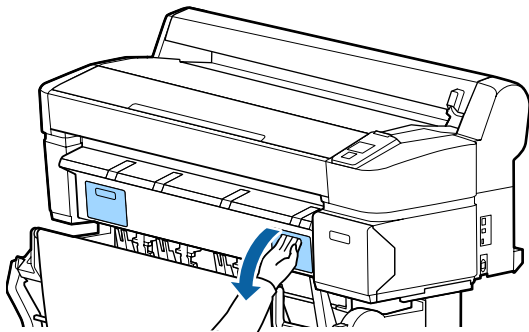

- 2 Pull the Maintenance Box out.

Lifting the Maintenance Box up releases the lock, and you can simply pull it straight out.

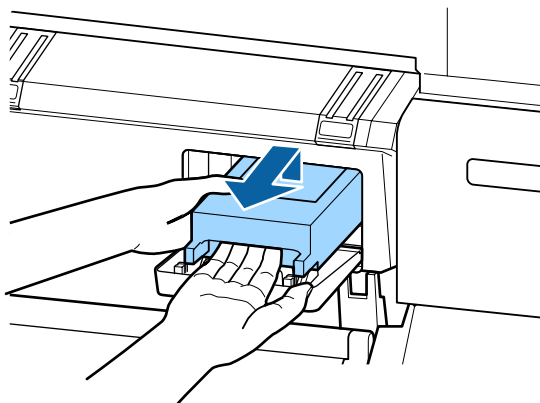

- 3 Place the used Maintenance Box in the clear bag included with your new Maintenance Box, and make sure that the zipper is closed tight.

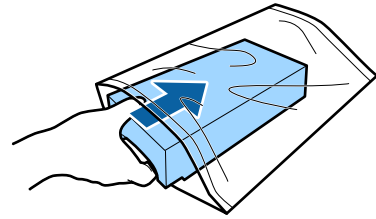

- 4 Install the new Maintenance Box.

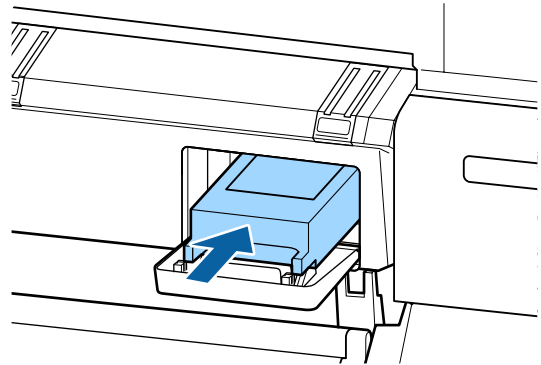

! **Important:**

Do not touch the IC chip on the Maintenance Box.

Doing so may prevent normal operation and printing.

- 5 Close the maintenance box cover.

Replacing the Cutter

Replace the cutter when it is not cutting paper cleanly.

Supported cutter

 [“Options and Consumable Products” on page 210](#)

Use a cross-head screwdriver to replace the cutter. Make sure you have a cross-head screwdriver with you before replacing the cutter.

Maintenance

! **Important:**

- ❑ Take care not to damage the cutter blade. Dropping it or knocking it against hard objects may chip the blade.
- ❑ The sheet stuck within the new cutter protects the blade. Do not remove the sheet before replacing the cutter.

! **Caution:**

Do not store the cutter within the reach of children. The cutter's blade could cause an injury. Pay careful attention when replacing the cutter.

Buttons that are used in the following settings

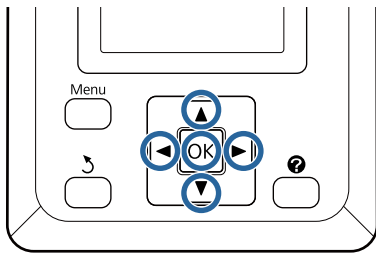

- 1** Remove any paper from the printer.
 - “Removing Roll paper or Roll 1” on page 36
 - “Removing Cut Sheets” on page 40
 - “Removing Poster Board” on page 44
- 2** Confirm that the printer is ready to print. Press the ◀/▶ buttons to select and press the OK button.

The Maintenance menu will be displayed.
- 3** Press the ▼/▲ buttons to select **Cutter Maintenance**, and then press the OK button.
- 4** Press the ▼/▲ buttons to highlight **Replace Cutter** and press the OK button.
- 5** The cutter will move to the replacement position.
- 6** Remove the old cutter from the printer.

Loosen the screw holding the cutter in place using a cross-head screwdriver and pull the cutter straight out.

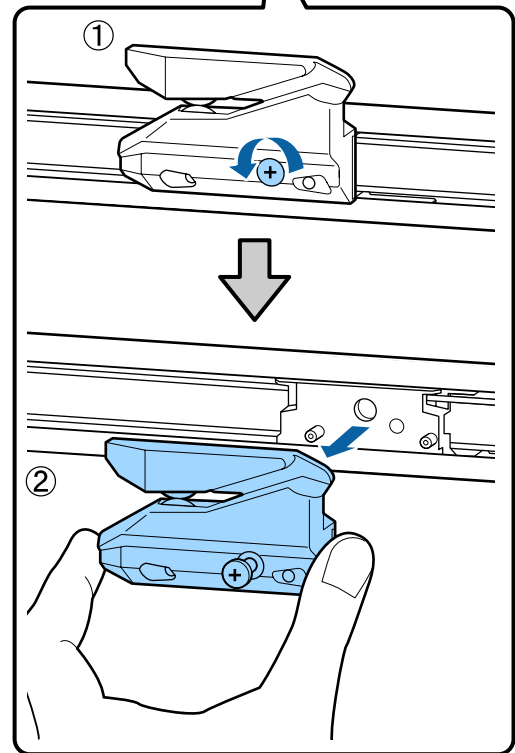
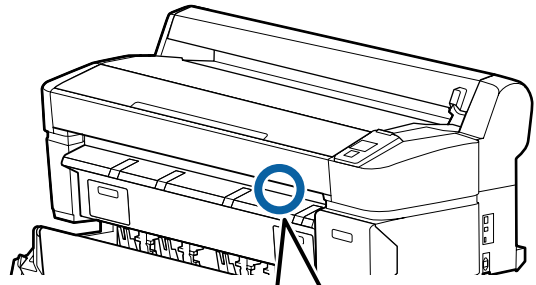

- 7** Install the new cutter.

Insert the cutter so that the pin on the printer matches up with the hole on the cutter. Use a cross-head screwdriver to tighten down the screw to hold the cutter in place.

! **Important:**

Screw up the cutter firmly, otherwise the cut position may be slightly shifted or skewed.

Maintenance

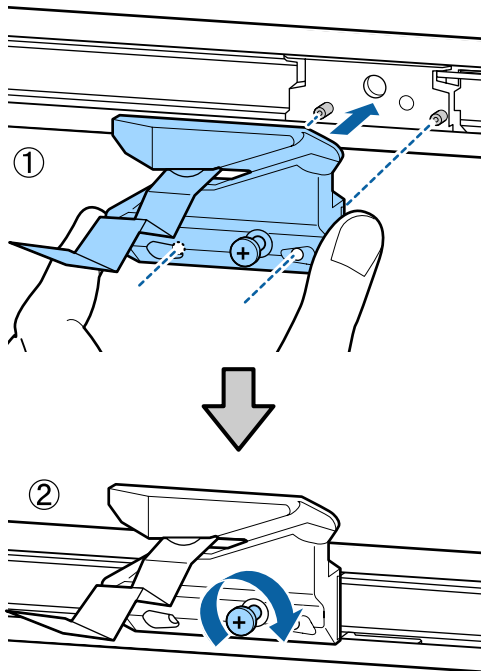

- 8** After replacing the cutter, press the OK button. The cutter will return to its original position. Remove the protective sheet after it automatically comes out from the cutter section. **Ready** is displayed in the control panel when the process is complete.

Cleaning the Printer

To keep your printer in optimum operating condition, clean it regularly (about once a month).

Cleaning the outside

- 1** Remove any paper from the printer.
- 2** Make sure the printer is turned off and the screen has turned off, and then unplug the power cable from the outlet.
- 3** Use a soft, clean cloth to carefully remove any dust or dirt.

In particular, clean the rear and sides so that dust does not accumulate. (The illustration below shows the printer when the Adobe PostScript 3 Expansion Unit is connected.)

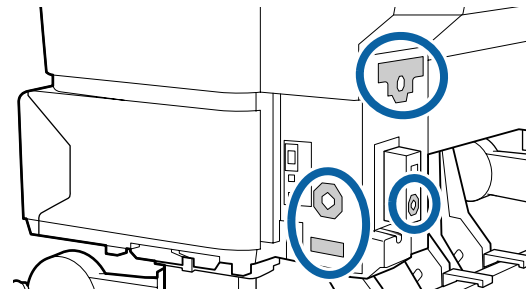

If there is a serious dirt problem, clean it using a soft, clean cloth dampened with a mild detergent. Then wipe off with a dry, soft cloth.

! Important:
 Never use benzene, thinners, or alcohol to clean the printer. They could cause discoloration and deformities.

Cleaning the inside

Dirt adheres to printed paper due to the dirty sections shown below.

Clean the target sections in such cases.

When the printed surface is scuffed or soiled
 Clean the pressure rollers.

Maintenance

 [“Cleaning the roller” on page 190](#)

When the reverse side of the printed paper is soiled
Clean the platen and the borderless printing absorption pad rim.

The platen and the borderless printing absorption pad rim is soiled by paper particles and ink that adhere.

 [“Cleaning the platen and the borderless printing absorption pad rim” on page 190](#)



Important:



Failure to remove paper particles and dust from the platen and borderless printing absorption pad rim can result in print head malfunctions or clogged nozzles.

Cleaning the roller

Follow the steps below to clean the roller by feeding plain paper.

- 1 Turn on the printer, and load it with widest available roll paper.

 [“Loading and Removing the Roll Paper” on page 29](#)

- 2 Press the  button followed by the  button.

Paper is fed while the  button is pressed. If the paper is not soiled, cleaning is complete.

Cut the paper after cleaning is done.

 [“Manual cut method” on page 35](#)

Cleaning the platen and the borderless printing absorption pad rim

- 1 Make sure the printer is turned off and the screen has turned off, and then unplug the power cable from the outlet.

- 2 Leave the printer for a minute.

3

Open the printer cover and clean each section.

Cleaning the Platen

With a soft cloth, thoroughly clean area (a) shown in blue in the illustration below. To avoid spreading the dirt, wipe from the inside to the outside. If there is a serious dirt problem, dampen a soft, clean cloth in a mild detergent, wring it well, and then use it clean the platen. Finally, wipe the inside of the printer with a dry, soft cloth.

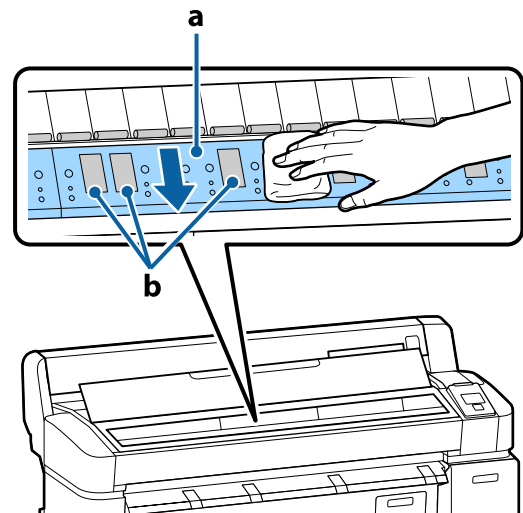

Important:

- Do not touch the roller or borderless printing absorption pads (“b” in gray) shown in the illustration above during cleaning. Otherwise, prints may be soiled.
- Be careful not to touch the ink tubes inside the printer. Otherwise, the printer may be damaged.

If any paper particles (that look like white powder) have accumulated on the platen, use something like a toothpick to push them in.

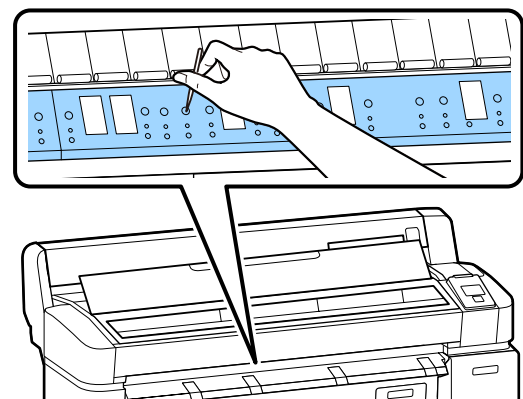

Maintenance

Cleaning the interior rim of the borderless printing absorption pad

If paper particles or dust have collected on the rims of the interior of section “b” in the illustration of the platen, wipe as shown using a commercially available cotton swab.

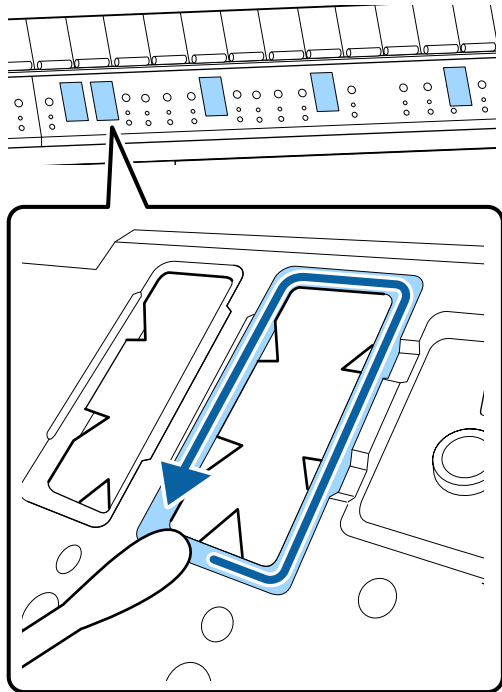

Important:

Do not strongly rub the borderless printing absorption pads. Otherwise, the borderless printing absorption pads may come off or rise and cause a malfunction or paper jam.

4

When you have finished cleaning, close the printer cover.

Cleaning the MFP Scanner (option)

If the glass surface or rollers of the scanner are covered in dust or stained, unwanted stripes and lines may appear in the copy results and scanned images.

After cleaning, if you feel that the problem is still not resolved, perform calibration.

 [“Calibration” on page 208](#)

1

Make sure the printer is turned off and the screen has turned off, and then unplug the power cable from the outlet.

2

Open the scanner cover.

Push up the lock levers on both ends of the cover to release the locks and open the cover.

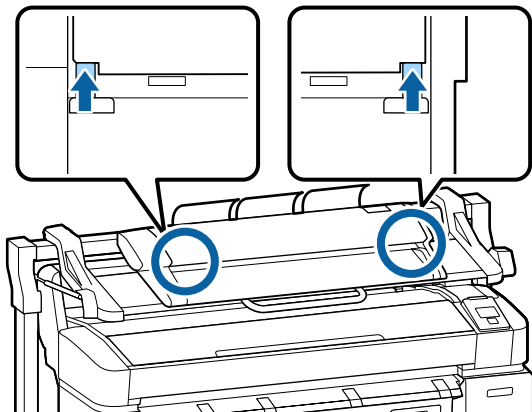

3

Clean the glass surface.

(1) Prepare two lint-free clean cloths.

Apply glass cleaner to one cloth, and then use it to wipe the glass surface.

Use a neutral glass cleaner that does not leave streaks.

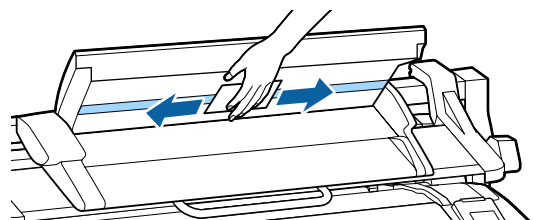

Maintenance

(2) Use the other cloth to wipe away any remaining glass cleaner.

4

Clean the roller directly under the glass surface.

Apply office-use liquid cleaner to a lint-free clean cloth, and then wipe the roller surface. While rotating the loading roller in front, wipe the roller well.

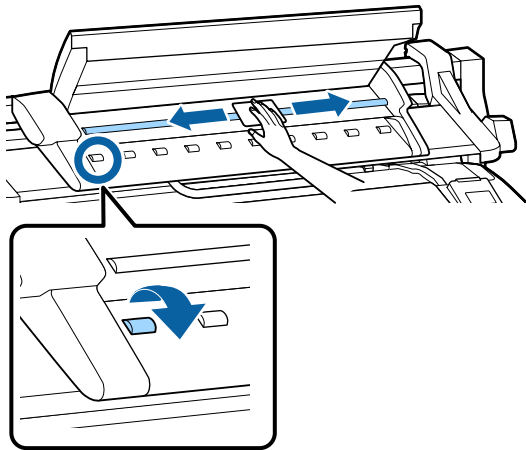

5

Close the scanner cover until you hear a click.

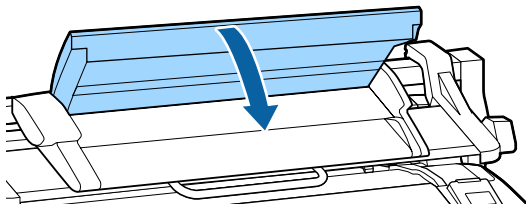









Problem Solver





Problem Solver

What to do When a Message is Displayed







If the printer displays one of the messages shown below, refer to the solution listed and take the necessary steps.

Messages	What to do
Ink Cartridge Error Ink cartridge cannot be recognized. Insert again or replace ink cartridge.	<ul style="list-style-type: none"> ❑ Remove and reinsert the ink cartridge. If the message persists, insert a new ink cartridge (do not reinstall the cartridge that caused the error).  "How to replace" on page 185 ❑ Condensation may occur in the ink cartridge. Leave it at room temperature for at least four hours before installing the ink cartridge.  "Notes on handling ink cartridges" on page 22
Ink Cartridge Error Ink cartridge cannot be detected. Insert again or replace ink cartridge.	
Ink Cartridge Error Please install the correct ink cartridge.	<p>Insert a genuine Epson ink cartridge approved for use in the printer.</p> <p> "Options and Consumable Products" on page 210</p> <p> "Replacing Ink Cartridges" on page 185</p>
Ink Low	<p>The ink is low. Ready a new ink cartridge.</p> <p> "Options and Consumable Products" on page 210</p>
Paper Load Error Paper from Roll 1 cannot be detected.	<p>Remove and then reload the roll paper in question.</p> <p>Before you reset the paper, cut the edge of the roll paper straight horizontally. Cut off any jagged or folded sections.</p>
Paper Load Error Paper from Roll 2 cannot be detected.	<p>If there is a problem with the edge, an automatic paper load error will occur.</p>
F/W Install Error Firmware update failed. Restart the printer.	<p>Turn the printer off, wait for a few minutes, and then turn on the printer again.</p> <p>Update the firmware again.</p> <p>If this message appears on the LCD panel again, contact your dealer or Epson Support.</p>
Command Error Check driver settings.	<p>Press the  button and select Job Cancel to stop printing. Confirm that the printer driver you are using supports this printer.</p>
Reel Unit Error Check Auto Take-up Reel Unit and restart printer.	<p>Turn the printer off, wait for a few minutes, and then turn on the printer again.</p> <p>If this message appears on the LCD panel again, contact your dealer or Epson Support.</p>
Reel Unit Error Connect Auto Take-up Reel Unit cable and restart printer.	<p>After reconnecting the cable connecting the auto take-up reel unit to the printer, turn the printer off and then on again.</p> <p> The <i>Setup Guide</i> supplied with the optional auto take-up reel unit.</p>
Reel Unit Disconnected Auto Take-up Reel Unit is disconnected. Do you continue?	<p>The auto take-up reel unit is not connected. After reconnecting the cable connecting the auto take-up reel unit to the printer, select No to turn the printer off. Turn the printer again after a short pause.</p> <p> The <i>Setup Guide</i> supplied with the optional auto take-up reel unit.</p> <p>To continue printing without using the auto take-up reel unit, select Yes.</p>









Problem Solver

Messages	What to do
<p>Take-Up Error Is anything obstructing the take-up reel sensor system?</p>	<p>After checking the take-up reel unit sensor and removing any obstructions, press the OK button.</p> <p>If there is loose paper around the take-up reel unit roll core, set the Auto switch to Off and keep the Manual pressed in the take-up direction to remove the slack. After confirming that the paper is correctly attached, return the Auto switch to its original position and press the OK button.</p> <p> "Using the Auto Take-up Reel Unit (SC-T7200 Series Only)" on page 53</p>
<p>HDD Error HDD used for another printer needs to be formatted. Continue?</p>	<p>Optional hard disk units and Adobe PostScript 3 Expansion Units that have been connected to other devices must be formatted after being connected to this printer. The disk can not be used until it is formatted.</p>
<p>Storage Error Check if hard disk unit is correctly installed.</p>	<p>Press the  button and select Job Cancel to stop printing. Remove and then reconnect the optional hard disk unit or Adobe PostScript 3 Expansion Unit.</p> <p>If this message appears on the LCD panel again, contact your dealer or Epson Support.</p> <p>When you are printing via the printer driver included with a printer, you can print regardless of the hard disk status if you select the Advanced tab in the printer driver, open the Settings dialog box of Hard Disk Unit, and select Print only. When the Adobe PostScript 3 Expansion Unit is connected, you cannot print via the PS driver.</p>
<p>Paper Cut Error Remove uncut paper.</p>	<p>After pressing the OK button, pull out the paper and cut along the line of the failed cut using scissors or a third-party cutter.</p> <p>Pull the edge of the paper straight outside the printer.</p>
<p>Data Size Error Data size of print job is too large. Check on print job.</p>	<p>The optional hard disk unit or Adobe PostScript 3 Expansion Unit can store print jobs up to 100 GB in size. To print larger jobs, select the Advanced tab in the printer driver, open the Settings dialog box of Hard Disk Unit, and select Print only; alternatively, ensure that print jobs are less than 100 GB in size.</p>
<p>HDD Store Error Hard disk does not have enough space. See documentation for how to delete stored print jobs.</p>	<p>Unwanted jobs can be deleted in Remote Manager or the LFP HDD Utility.</p> <p> "Saving to and Reprinting on the Optional Hard Disk Unit" on page 69</p>
<p>HDD Boot Error Hard disk error. Hard disk cannot be used.</p>	<p>Press the OK button to clear the error from the control panel. When you are printing via the printer driver included with the printer, you can print regardless of the hard disk unit status when you select Print only in the Settings dialog box of Hard Disk Unit. When the Adobe PostScript 3 Expansion Unit is connected, you cannot print via the PS driver.</p> <p>If this message appears on the LCD panel again, contact your dealer or Epson Support.</p>
<p>Checking hard disk</p>	<p>Data saved to the optional hard disk unit or Adobe PostScript 3 Expansion Unit (hereinafter referred to as the hard disk) is being checked. If the results of the check indicate that data restoration is necessary, the restoration is carried out next. Restoration may take up to 20 minutes.</p> <p>If the restoration ends, the start completes.</p> <p>If it was not possible to restore the data, the format menu of the hard disk appears. If the hard disk is formatted, the hard disk can be used again. If you exit the menu without formatting the hard disk, only printing that does not use the hard disk is possible.</p>
<p>Copy Error Can not start copy with this printer setting. Refer to manual for details.</p>	<p>The printer will be unable determine the size of the current paper and make enlarged copies when Off is selected for Paper Size Check in the Setup menu. In the Setup menu, set Paper Size Check to On, and then reload the paper.</p> <p>The changed settings are applied after the paper is reloaded. Note that they are not applied if you just change the menu items.</p> <p> "Setup menu" on page 154</p>

Problem Solver

Messages	What to do
<p>Scanner Error Refer to manual for details.</p>	<ul style="list-style-type: none"> <input type="checkbox"/> Release the A3/A4 scanner transportation lock and turn the printer and scanner off and then on again. <input type="checkbox"/> Turn the devices on and off several times. The scanner can be used after the message is no longer displayed. <p>If this message appears on the LCD panel again, contact your dealer or Epson Support.</p>
<p>Held Jobs Limit Held job queue full.</p>	<p>The number of held jobs has reached 200.</p> <p>Press the OK button and select Resume All Jobs.</p> <p> "Function Summary" on page 69</p>
<p>Paper Size Error Loaded paper is not supported size.</p>	<p>The loaded paper width is not supported. Press the OK button and remove the paper.</p> <p>Paper for use in the printer must be at least 254 mm wide. Use paper that is at least 254 mm wide.</p> <p>Should this message be displayed with paper of a width that can be used in the printer, you may be able to print if you select Off for Paper Size Check in the Setup menu.</p> <p>The changed settings are applied after the paper is reloaded. Note that they are not applied if you just change the menu items.</p> <p> "Setup menu" on page 154</p>
<p>Paper Sensor Error Loaded paper or print out has a problem. Refer to manual for details.</p>	<p>Press the  button to clear the error from the control panel.</p> <p>If this error is displayed when performing automatic head alignment, check the following items.</p> <ul style="list-style-type: none"> <input type="checkbox"/> Does the paper support auto head alignment? Head alignment is not available with transparent or colored media, tracing paper, paper not supported by the auto head alignment function, or paper that is 1.0 mm or more thick. See the following for information on the types of paper that support auto head alignment.  "Epson Special Media Table" on page 212 <input type="checkbox"/> Are outside light sources interfering with the process? If the printer is exposed to direct sunlight or another light source that causes optical interference, shade the printer from these sources. <input type="checkbox"/> Are the default values selected for both Platen Gap and Less Head Scuffing? Restore both items to their default values. <input type="checkbox"/> Are some print head nozzles clogged? Perform head cleaning.  "Head Cleaning" on page 180 <p>If this error is displayed in circumstances other than those listed above, check that the printer supports the current paper.</p>
<p>Roll Setting Error Specified roll paper is not loaded. Continue to print with paper currently loaded?</p>	<p>In Source of the printer driver, roll paper which is not loaded is selected.</p> <p>If the OK button is pressed, the printer is forced to print using the loaded roll paper.</p> <p>If the  button is pressed, paper can be loaded.</p>

Problem Solver

Messages	What to do
<p>Paper Type Error Cannot switch to specified roll paper because paper type is different. Continue to print with paper currently loaded?</p>	<p>The Media Type setting of the printer driver and the paper type of the roll paper loaded on the printer are different.</p> <p>If the OK button is pressed, the printer prints to the roll paper currently in use.</p> <p>If the  button is pressed, paper can be switched.</p> <p>If you want to switch a roll paper even though it is a different type, open the Setup menu, and then under Roll Switch Condition, change Paper Type to Disable.</p> <p> "Setup menu" on page 154</p>
<p>Paper Width Error Cannot switch to specified roll paper because paper width is different. Continue to print with paper currently loaded?</p>	<p>The Source setting of the printer driver and the width of the roll paper loaded on the printer are different.</p> <p>If the OK button is pressed, the printer prints to the roll paper currently in use.</p> <p>If the  button is pressed, paper can be switched.</p> <p>If you want to switch a roll paper even though it is a different paper width, open the Setup menu, and then under Roll Switch Condition, change Paper Width to a setting other than Width Match.</p> <p> "Setup menu" on page 154</p>
<p>Paper Length Error Insufficient remaining amount in specified roll paper. Continue to print with paper currently loaded?</p>	<p>The remaining amount of roll paper loaded in Roll 1 and Roll 2 is shorter than the print length, so the roll paper cannot be switched.</p> <p>If the OK button is pressed, the printer prints to the roll paper currently in use.</p> <p>If the  button is pressed, paper can be switched.</p> <p>If you want to print even though remaining amount of roll paper is shorter than the print length, open the Setup menu, and then under Roll Switch Condition, change Paper Length to a setting other than Print Length.</p> <p> "Setup menu" on page 154</p>
<p>Roll Switch Error Cannot switch roll paper automatically. Check printer settings. Continue to print with paper currently loaded?</p>	<p>If one of the following settings in the Setup menu is set as follows, roll paper is not switched automatically.</p> <ul style="list-style-type: none"> <input type="checkbox"/> Auto Cut is Off. <input type="checkbox"/> Auto Loading is Off. <p>If the OK button is pressed, the printer prints to the roll paper currently in use.</p> <p>If the  button is pressed, paper can be switched.</p> <p>To enable automatic switching of roll paper, change both settings above to On.</p> <p> "Setup menu" on page 154</p>
<p>Firmware Error Firmware mismatch between PS3 Expansion Unit and printer. Refer to manual for details.</p>	<p>Operation is not possible because the versions of firmware of the optional Adobe PostScript 3 Expansion Unit and the firmware of the printer are not compatible.</p> <p>Update both to the latest firmware.</p> <p>The latest firmware can be downloaded from the Epson website.</p>
<p>Information Cannot start copy because non-supported media is loaded. Refer to manual for details.</p>	<p>Load paper that supports large copy/large scan, and then print the copy/scan file again.</p> <p>For paper that supports large copy/large scan, see the following.</p> <p> "Epson Special Media Table" on page 212</p>

Problem Solver

Messages	What to do
<p>Information Cannot send file. Refer to manual for details.</p>	<p>If you tried to copy or send a large-scan image file to a shared folder, and this message appears, check the following.</p> <ul style="list-style-type: none"> <input type="checkbox"/> Are the folder path, user name, and password configured correctly in the shared folder address setting of Copy Manager? <input type="checkbox"/> Is there already a file with the same name in the save/transfer destination folder? <input type="checkbox"/> Is there sufficient empty space in the save/destination folder? <p>If you tried to send an e-mail, and this message appears, ask your network administrator if the e-mail settings have been configured correctly.</p>
<p>Information Cannot receive mail. Refer to manual for details.</p>	<p>Ask your network administrator if the e-mail settings have been configured correctly.</p>
<p>Information Folder setting has not been made. Configure folder setting with Remote Manager.</p>	<p>Use Remote Manager to configure the shared folder settings in advance and then perform Print From Folder.</p> <p> "Preparing to Print From Folder" on page 87</p>

When a Maintenance Call/Service Call Occurs

Error messages	What to do
<p>Maintenance Request Replace Part Now/Soon XXXXXXXX</p>	<p>A part used in the printer is nearing the end of its service life.</p> <p>Contact your dealer or Epson Support and tell them the maintenance request code.</p> <p>You cannot clear the maintenance request until the part is replaced. A service call occurs if you continue to use the printer.</p>
<p>Call For Service XXXX Error XXXX Power off and then on. If this doesn't work, note the code and call for service.</p>	<p>A call for service occurs when:</p> <ul style="list-style-type: none"> <input type="checkbox"/> The power cable is not connected securely <input type="checkbox"/> An error that cannot be cleared occurs <p>When a call for service has occurred, the printer automatically stops printing. Turn off the printer, disconnect the power cable from the outlet and from the AC inlet on the printer, and then reconnect. Turn on the printer again multiple times.</p> <p>If the same call for service is displayed on the LCD panel, contact your dealer or EpsonSupport for assistance. Tell them the call for service code is "XXXX".</p>

Problem Solver

Troubleshooting

You cannot print (because the printer does not work)

The printer does not turn on.

■ **Is the power cable plugged into the electrical outlet or the printer?**

Make sure the power cable is securely plugged into the printer.

■ **Is there a problem with the power outlet?**

Make sure your outlet works by connecting the power cable for another electric product.

The printer turns off automatically.

■ **Is Power Off Timer enabled?**

To prevent the printer turning off automatically, select **Off**.

 ["Setup menu" on page 154](#)

The printer driver is not installed properly (Windows).

■ **Is the icon for this printer displayed in the Devices and Printers/Printer/Printers and Faxes folder?**

Yes

The printer driver is installed. See "The printer is not connected correctly to the computer" on the next page.

No

The printer driver is not installed. Install the printer driver.

■ **Does the printer port setting match the printer connection port?**

Check the printer port.

Click the **Port** tab in the printer Properties dialog and check the option selected for **Print to following port(s)**.

USB: **USBxxx** (x stands for the port number) for the USB connection

Network: The correct IP address for the network connection

If it is not indicated, the printer driver is not installed correctly. Delete and reinstall the printer driver.

 ["Uninstalling the printer driver" on page 132](#)

The printer driver is not installed properly (Mac OS X).

■ **Is the printer added to the printer list?**

Select **System Preferences > Print & Scan** (or **Print & Fax**) from the Apple menu.

If the printer name is not displayed, add the printer.

The printer is not communicating with the computer.

■ **Is the cable plugged in properly?**

Confirm that the interface cable is securely connected to both the printer port and the computer. Also, make sure the cable is not broken nor bent. If you have a spare cable, try connecting with the spare cable.

■ **Does the interface cable specification match the specifications for the computer?**

Make sure the interface cable specifications match the specifications for the printer and the computer.

 ["System Requirements" on page 225](#)

■ **When using a USB hub, is it being used correctly?**

In the USB specification, daisy-chains of up to five USB hubs are possible. However, we recommend that you connect the printer to the first hub connected directly to the computer. Depending on the hub you are using, the operation of the printer may become unstable. If this should occur, plug the USB cable directly into your computer's USB port.

Problem Solver

■ Is the USB hub recognized correctly?

Make sure the USB hub is recognized correctly on the computer. If the computer correctly detects the USB hub, disconnect all USB hubs from the computer and connect the printer directly to the computer USB port. Ask the USB hub manufacturer about USB hub operation.

You cannot print under the network environment.

■ Are the network settings correct?

Ask your network administrator for the network settings.

■ Connect the printer directly to the computer using a USB cable, and then try to print.

If you are able to print via USB, there is a problem with network settings. Ask your system administrator, or refer to the manual for your network system. If you cannot print via USB, see the appropriate section in this User's Guide.

You cannot obtain printer information from software under a network environment.

■ Is the SNMPv1/v2c setting disabled?

If the SNMPv1/v2c setting is disabled in Remote Manager, software that uses the SNMPv1/v2c protocol may be unable to obtain printer information. (Example: It is not possible to check from the printer driver the amount of ink remaining)

To change the SNMP setting, consult your system administrator.

 ["How to use Remote Manager" on page 27](#)

The printer has an error.

■ View the message displayed in the control panel.

 ["Control panel" on page 14](#)

 ["What to do When a Message is Displayed" on page 193](#)

The printer stops printing.

■ Is the status of print queue Pause? (Windows)

If you stop printing or the printer stops printing because of an error, the print queue enters a **Pause** status. You cannot print in this status.

Double-click the printer icon in the **Devices and Printers, Printers**, or **Printers and Faxes** folder; if printing is paused, open the **Printer** menu and clear the **Pause** check box.

■ Does the current printer status show Printing Paused (Mac OS X)?

Open the status dialog for your printer and check whether printing is paused.

(1) Select **System Preferences > Print & Scan** (or **Print & Fax**) > **Open Print Queue** from the **Apple** menu.

(2) Double-click the icon for any printer that is **Paused**.

(3) Click **Resume Printer**.

Your problem is not listed here.

■ Decide whether the trouble is caused by the printer driver or the application. (Windows)

Perform a test print from the printer driver so that you can check that the connection between the printer and computer is correct and the printer driver settings are correct.

(1) Make sure that the printer is turned on and in ready status, and load A4 or larger paper.

(2) Open the **Devices and Printers, Printers**, or **Printers and Faxes** folder.

(3) Right-click the target printer icon, and select **Properties**.

(4) In the Properties dialog, select the **General** tab and click **Print Test Page**.

After a while the printer starts to print a test page.

If the test page is printed correctly, the connection between the printer and computer is correct. Go to the next section.

If the test page is not printed correctly, check the items above again.

 ["You cannot print \(because the printer does not work\)" on page 198](#)

The "Driver Version" shown on the test page is the version number of the Windows internal driver. This differs from the Epson printer driver version that you installed.

Problem Solver

The printer sounds like it is printing, but nothing prints

The print head moves, but nothing prints.

- Confirm the printer operation.**
Print a nozzle check pattern. Because a nozzle check pattern can be printed without connecting to a computer, you can check the operations and print status for the printer. [☞ "Checking for clogged nozzles" on page 179](#)

Check the next section if the nozzle check pattern is not printed correctly.

- Is the message Motor Self Adjustment displayed on the control panel's screen?**
The printer adjusts the internal motor. Wait for a while without turning off the printer.

The nozzle check pattern is not printed correctly.

- Perform head cleaning.**
The nozzles may be clogged. Print a nozzle check pattern again after performing head cleaning.
[☞ "Cleaning the print head" on page 180](#)

- Has the printer been left unused for a long time?**
If the printer has not been used for a long time, the nozzles may have dried up and have been clogged.

The prints are not what you expected

Print quality is poor, uneven, too light, or too dark.

- Are the print head nozzles clogged?**
If the nozzles are clogged, specific nozzles do not fire ink and the print quality declines. Print a nozzle check pattern.
[☞ "Checking for clogged nozzles" on page 179](#)

- Was Head Alignment performed?**
With bidirectional printing, the print head prints while moving left and right. If the print head is misaligned, ruled lines may be misaligned accordingly. If vertical ruled lines are misaligned with bidirectional printing, perform Head Alignment.
[☞ "Aligning print position misalignment \(Head Alignment\)" on page 181](#)

- Are you using a genuine Epson ink cartridge?**
This printer is developed for use with Epson ink cartridges. If you use non-Epson ink cartridges, printouts may be faint, or the color of the printed image may be changed because the remaining ink level is not correctly detected. Be sure to use the correct ink cartridge.

- Are you using an old ink cartridge?**
The print quality declines when an old ink cartridge is used. Replace the old ink cartridge with a new one. We recommend using all the ink in the cartridge before the expiry date printed on the package (within a year of installation).

- Have the ink cartridges been shaken?**
The ink cartridges for this printer contain pigment inks. Shake the cartridges thoroughly before installing them in the printer.
We also recommend that you remove and shake the installed ink cartridges once every three months to ensure print quality.
[☞ "Replacing Ink Cartridges" on page 185](#)

- Are the Media Type settings correct?**
Print quality is affected if the **Media Type** you have selected in the Printer Settings screen (Windows) or Print screen (Mac OS X) in the printer driver does not match with the paper that is loaded in the printer. Be sure to match the media type setting with the paper that is loaded in the printer.

- Did you select a low quality mode (such as Speed) as the Print Quality?**
If the options selected for **Print Quality > Advanced Settings** place priority on speed, quality will be sacrificed for print speed, potentially causing print quality to decline. To improve print quality, select **Resolution** options that give priority to quality.

- Is color management enabled?**
Enable color management.
[☞ "Color Management Printing" on page 120](#)

Problem Solver

■ Have you compared the printing result with the image on the display monitor?

Since monitors and printers produce colors differently, printed colors will not always match on-screen colors perfectly.

■ Did you open the printer cover while printing?

If the printer cover is opened while printing, the print head stops suddenly causing unevenness in the color. Do not open the printer cover while printing.

■ Is Ink Low displayed in the control panel?

The print quality may decline when the ink is low. We recommend replacing the ink cartridge with a new one. If there is a difference in color after replacing the ink cartridge, try performing head cleaning a few times.

The color is not exactly the same as another printer.

■ Colors vary depending on the printer type due to each printer's characteristics.

Because inks, printer drivers, and printer profiles are developed for each printer model, the colors printed by different printer models are not exactly the same.

You can achieve similar colors with the same color adjustment method or the same gamma setting by using the printer driver.

 ["Color Management Printing" on page 120](#)

To match the color precisely, use the color measurement device to perform color management.

The print is not positioned properly on the media.

■ Have you specified the print area?

Check the print area in the settings of the application and the printer.

■ Is the correct option selected for Paper Size?

If the option selected for **Paper Size** in the printer driver does not match the paper loaded in the printer, the print may not be in the correct position or some of the data may be printed off the paper. In this case, check the print settings.

■ Is the paper skewed?

If **Off** is selected for **Media Skew Check** in the Setup menu, printing will continue even if the paper is skewed, resulting in data being printed off the paper. Select **On** for **Paper Skew Check** in the Setup menu.

 ["Setup menu" on page 154](#)

■ Does the print data fit within the paper width?

Although under normal circumstances printing stops if the print image is wider than the paper, the printer may print outside the bounds of the paper when **Off** is selected for **Paper Size Check** in the Setup menu. Select **On** for **Paper Size Check** in the Setup menu.

The changed settings are applied after the paper is reloaded. Note that they are not applied if you just change the menu items.

 ["Setup menu" on page 154](#)

■ Is the roll paper margin set to 15 mm or 35 mm?

If the value selected for **Roll Paper Margin** in the Setup menu is wider than the margins selected in the application, priority will be given to the value selected for **Roll Paper Margin**. For example, if 15 mm is selected for the left and right margins in the printer Setup menu and the document fills the page, the 15 mm at the left and right sides of the page will not be printed.

 ["Printable area" on page 65](#)

Vertical ruled lines are misaligned.

■ Is the print head misaligned? (in bidirectional printing)

With bidirectional printing, the print head prints while moving left and right. If the print head is misaligned, ruled lines may be misaligned accordingly. If vertical ruled lines are misaligned with bidirectional printing, perform Head Alignment.

 ["Aligning print position misalignment \(Head Alignment\)" on page 181](#)

Problem Solver

■ Was printing performed with Epson special media after head alignment with commercially available paper?

If the paper thickness was not configured correctly when commercially available paper was configured in the Custom Paper Setting, head alignment is not performed correctly, and a malfunction may occur during printing with Epson special media. In the Maintenance menu under Head Alignment, choose the Epson special media you will use, and then perform head alignment again.

 ["Aligning print position misalignment \(Head Alignment\)" on page 181](#)

■ Widen the bottom margin

Depending on the paper usage, storage conditions, and the content of the print data, the bottom edge may be scuffed when printing. In this situation it is best to create your data with a wider bottom margin.

■ Does the interior of the printer need cleaning?

The rollers may need cleaning. Clean the rollers by feeding and ejecting paper.

 ["Cleaning the inside" on page 189](#)

The printed surface is scuffed or soiled.

■ Is the paper too thick or too thin?

Check that the paper specifications are compatible with this printer. For information about the media types and appropriate settings for printing on paper from other manufacturers or when using RIP software, see the documentation supplied with the paper, or contact the dealer of the paper or the manufacturer of the RIP.

■ Is the paper wrinkled or creased?

Do not use old paper or paper with creases in it. Always use new paper.

■ Is the paper wavy or curled?

Cut sheets become wavy or curls due to changes in temperature or humidity which may result in the printer being unable to recognize the paper size correctly. Flatten the paper before loading it in the printer, or use new paper.

■ Is the print head scuffing the printed surface?

If the surface of the paper is scuffed, select a **Platen Gap** option between **Wide** and **Wider** in the Paper menu.

 ["Paper menu" on page 149](#)

■ Is the print head scuffing the edge of the paper?

Select **Top35mm/Bottom15mm** for the **Roll Paper Margin** option in the Setup menu.

 ["Setup menu" on page 154](#)

You see damage on the print surface

■ Is there dust in the path of Roll 2?

Open the rear cover, and then wipe away the dust with a dry, lint-free cloth.

Opening the rear cover  ["Roll paper jam" on page 204](#)

The paper is creased.

■ Are you using the printer at normal room temperature?

Epson special media should be used at normal room temperature (temperature: 15 to 25°C, humidity: 40 to 60%). For information about paper such as thin paper from other manufacturers that requires special handling, see the documentation supplied with the paper.

■ When using non-Epson special media, have you made the paper configuration?

When using non-Epson special media, configure the paper characteristics (custom paper) before printing.

 ["Before printing on non-Epson media" on page 222](#)

Problem Solver

The reverse side of the printed paper is soiled.

■ **Select On for Paper Size Check in the menus.**

Although printing normally stops if the print image is wider than the paper, when **Off** is selected for **Paper Size Check** in the Setup menu, the printer may print outside the bounds of the paper, getting ink on the inside of the printer in the process. This can be prevented by selecting **On** for **Paper Size Check** in the Setup menu.

The changed settings are applied after the paper is reloaded. Note that they are not applied if you just change the menu items.

 ["Setup menu" on page 154](#)

■ **Is ink dry on the printed surface?**

Depending on the printing density and media type, the ink may take a while to dry. Do not stack the paper until the printed surface is dry.

Also, if you set the **Drying Time per Page** in **Paper Configuration** from the printer driver, you can stop the operation after printing (ejecting and cutting paper) and wait until the ink is dry. See the printer driver help for more details on the Paper Configuration dialog box.

 ["Cleaning the inside" on page 189](#)

■ **Has the platen and the borderless printing absorption pad rims collected paper particles?**

If the printer is used after paper particles or dust have accumulated, they may absorb ink and soil the rear side of the paper. Check the platen and the borderless printing absorption pad rims and clean any paper particles or dust.

 ["Cleaning the platen and the borderless printing absorption pad rim" on page 190](#)

Too much ink is fired.

■ **Are the Media Type settings correct?**

Make sure that the printer driver's **Media Type** settings match the paper that you are using. The amount of ink to be fired is controlled according to the media type. If the settings do not match the paper loaded, too much ink may be fired.

■ **Is the Color Density setting correct?**

Lower the density of the ink in the **Paper Configuration** dialog box from the printer driver. The printer may be printing with much ink for some paper. See the printer driver help for more details on the Paper Configuration dialog box.

■ **Are you printing on tracing paper?**

If too much ink is used when printing in **B&W** on tracing paper, you may get better results by choosing a lower print density in the **Paper Configuration** dialog box or by selecting **Tracing Paper <Low Duty>** for **Media Type**.

Margins appear in borderless printing.

■ **Are the settings for the print data in the application correct?**

Make sure that the paper settings in the application are correct as well as in the printer driver.

 ["Borderless Printing" on page 102](#)

■ **Are the paper settings correct?**

Make sure that the paper settings of the printer match the paper that you are using.

■ **Have you changed the amount of enlargement?**

Adjust the amount of enlargement for borderless printing. Margins may appear if you set the amount of enlargement to **Min**.

 ["Borderless Printing" on page 102](#)

■ **Is the paper stored correctly?**

The paper may expand or contract if it is not stored correctly so that margins appear even when borderless is set. See the documentation supplied with the paper for more information on the storage method.

■ **Are you using paper that supports borderless printing?**



Paper that does not support borderless printing may expand or contract while printing so that margins appear even when borderless is set. We recommend using paper that is designed to support borderless printing.

Problem Solver

- Try adjusting the cutter.**
 When there are margins on the top of the roll paper while performing borderless printing, try performing **Adjust Cut Position**. It may reduce the margins.
 ["Maintenance menu" on page 153](#)

Feeding or ejecting problems

Unable to feed or eject paper.

- Is the paper loaded in the correct position?**
 See the following for the correct paper loading positions.
 ["Attaching the Roll Paper Adapter" on page 29](#)
 ["Loading and Removing Cut Sheets" on page 39](#)
 ["Loading and Removing Poster Board" on page 41](#)
 If the paper is loaded correctly, check the condition of the paper that you are using.

- Is the paper loaded in the correct direction?**
 Load cut sheets vertically. If they are not loaded in the correct direction, the paper may not be recognized and an error may occur.
 ["Loading and Removing Cut Sheets" on page 39](#)

- Is the paper wrinkled or creased?**
 Do not use old paper or paper with creases in it. Always use new paper.

- Is the paper damp?**
 Do not use paper that is damp. Also, Epson special media should be left in the bag until you intend to use it. If it is left out for a long time, the paper curls up and gets damp so that it does not feed properly.

- Is the paper wavy or curled?**
 Cut sheets become wavy or curled due to changes in temperature or humidity which may result in the printer being unable to recognize the paper size correctly. Flatten the paper before loading it in the printer, or use new paper.

- Is the paper too thick or too thin?**
 Check that the paper specifications are compatible with this printer. For information about the media types and appropriate settings for printing on paper from other manufacturers or when using RIP software, see the documentation supplied with the paper, or contact the dealer of the paper or the manufacturer of the RIP.

- Are you using the printer at normal room temperature?**
 Epson special media should be used at normal room temperature (temperature: 15 to 25°C, humidity: 40 to 60%).

- Is paper jammed in the printer?**
 Open the printer cover of the printer and check that there are no paper jams or foreign objects in the printer. If paper is jammed, see "Paper jams" below and clear the jammed paper.

- Is the paper suction too strong?**
 If you continue to have problems with ejected paper, try lowering the Paper Suction (the amount of suction used to keep the paper on the paper feed path).  ["Paper menu" on page 149](#)

Paper does not collect in the paper basket or is creased or folded when the paper basket is used.

- Does the print job require a lot of ink, or is the humidity of the workplace high?**
 Depending on the job and the work environment, paper may not collect in the paper basket. Take the following measures as appropriate.
 - Paper does not collect in the paper basket: Use your hands to lightly press the paper into the paper basket as it is ejected from the printer.
 - The paper folds after it has been cut automatically: Select manual cutting and take the paper in both hands after it is cut.
 - The paper creases and does not collect well in the paper basket: Resume printing after closing the paper basket. Before the paper ejected from the printer touches the floor, take it in both hands close to the paper eject guides and continue to lightly support it until printing is complete.

Roll paper jam

To remove jammed paper, follow the steps below:

Problem Solver

⚠ Caution:

If you opened the printer cover in operation, do not touch the area as indicated by the warning labels.

High temperatures may cause burns.

- 1** Turn off the printer.
- 2** Turn the printer on.
After a pause, the message **Follow instructions on screen to clear jammed paper.** will appear in the display.
- 3** Cut the top portion of any torn or crinkled areas using a commercially available cutter.

Roll Paper/Roll 1

Cut the paper as shown.

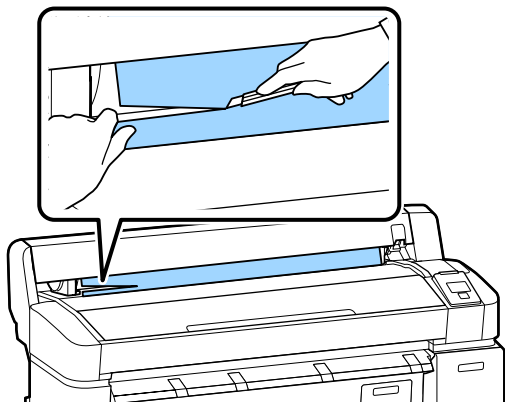

Roll 2 (SC-T7200D Series/SC-T5200D Series)

- (1)** Open the rear cover.

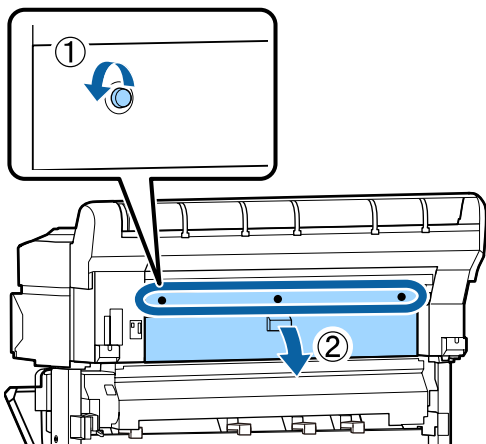

- (2)** Pull the paper up from the bottom and cut as shown.

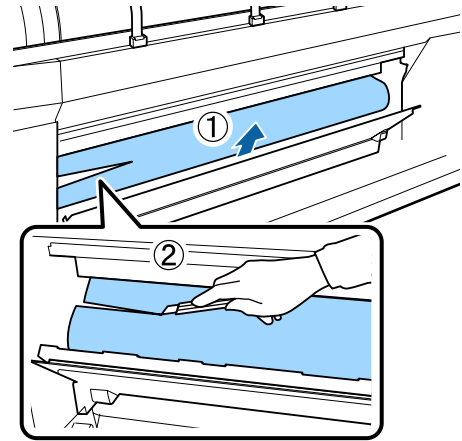

- 4** Press the OK button.
- 5** Open the printer cover, move the print head away from the jam, and press the OK button.

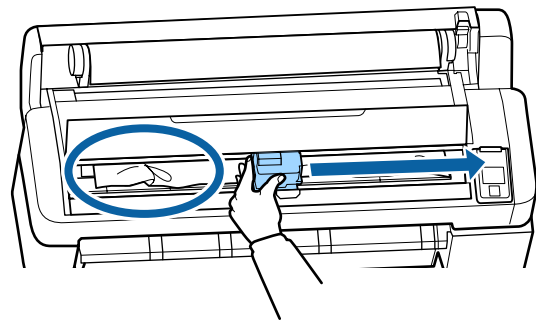

⚠ Important:

Other than when you are removing paper jams, do not touch the print head. If you touch the print head with your hand, static electricity may cause a malfunction.

- 6** Hold the ▼ button until all the cut paper is clear of the printer.
- 7** Remove the cut paper.

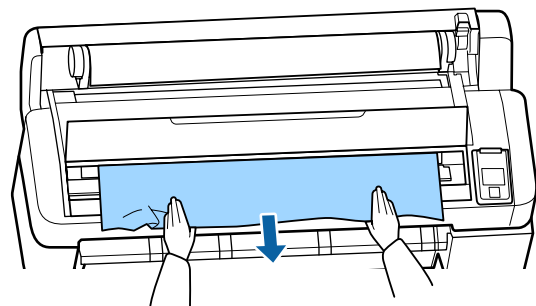

Problem Solver

8 After removing the paper, press the OK button.

Roll Paper/Roll 1

Proceed to Step 10.

Roll 2 (SC-T7200D Series/SC-T5200D Series)

Close the rear cover as described in Step 9.

9 Close the rear cover and tighten the three fixing screws.

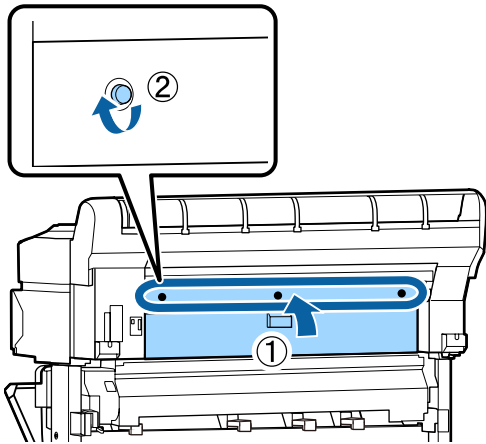

10 Close the printer cover.

When the message **Press [OK] and load paper.** is displayed, reload the paper and resume printing.

[“Loading Roll Paper or Roll 1” on page 30](#)

[“Loading Roll 2\(SC-T7200D Series/SC-T5200D Series only\)” on page 33](#)

! Important:
 Before you reload the roll paper, cut the edge straight horizontally. Cut any wavy or creased sections.
 If there is a problem at the edge, decreased print quality and paper jams may occur.

Cut sheets jam

To remove jammed paper, follow the steps below:

! Caution:
 If you opened the printer cover in operation, do not touch the area as indicated by the warning labels.
 High temperatures may cause burns.

1 Turn off the printer.

2 Turn the printer on.

After a pause, the message **Follow instructions on screen to clear jammed paper.** will appear in the display.

3 Open the printer cover, move the print head away from the jam, and press the OK button.

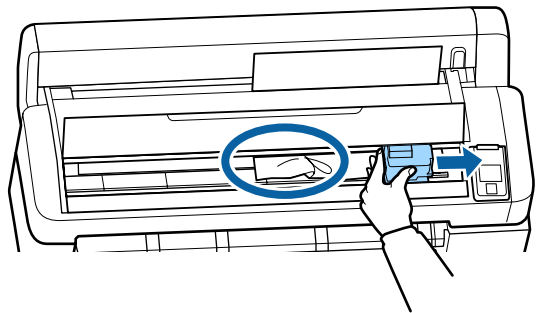

! Important:
 Other than when you are removing paper jams, do not touch the print head. If you touch the print head with your hand, static electricity may cause a malfunction.

4 Hold the ▼ button until all the affected paper is clear of the printer.

5 Cut off the affected portion.

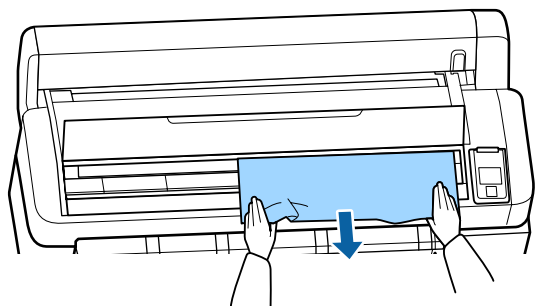

6 Remove the paper and press the OK button.

7 Close the printer cover.

When the message **Press [OK] and load paper.** is displayed, reload the paper and resume printing.

[“Loading and Removing Cut Sheets” on page 39](#)

Problem Solver

Others

The control panel display keeps turning off.

■ **Is the printer in sleep mode?**

Sleep mode is exited if a print job is received or the ⏻ button on the control panel is pressed. The delay before the printer enters sleep mode can be selected in the Setup menu.

👉 ["Setup menu" on page 154](#)

Color ink runs out quickly even when printing in the Black&White mode or when printing black data.

■ **Color ink is consumed during the head cleaning process.**

If all nozzles are selected when you perform **Head Cleaning** or **Power Cleaning**, inks of all colors will be used. (This is true even if you are currently printing in black and white.)

👉 ["Cleaning the print head" on page 180](#)

The paper is not cut cleanly.

■ **Replace the cutter.**

If the paper is not cut cleanly, replace the cutter.

👉 ["Replacing the Cutter" on page 187](#)

A light is visible inside the printer.

■ **This is not a failure.**

The light is a light inside the printer.

The administrator password has been lost

- Should you forget the administrator password, contact your dealer or Epson Support.

Head cleaning starts when the printer is turned on.

- When turned on after an extended period of disuse, the printer may automatically perform head cleaning to ensure print quality.

Head cleaning will end after about 10 to 15 minutes.

Trouble when the optional MFP Scanner is connected

The Large Copy/Large Scan tab does not appear on the control panel

■ **Is the power switch of MFP Scanner off?**

Flip the power switch of MFP Scanner to the minus (-) side to switch on the power, and then turn the printer off and then on again.

■ **Is the AC adapter plugged into the electrical outlet and the MFP Scanner?**

After reconnecting the cable of the AC adapter, turn the printer off and then on again.

■ **Is the connection cable plugged in properly?**

Confirm that the connection cable is securely connected to the ports of the printer and the MFP Scanner. Also, make sure the cable is not broken.

Document width is not recognized correctly

■ **The rollers or glass surface of the MFP Scanner may be soiled.**

Turn off the printer and open the scanner cover, and then clean the rollers and glass surface.

👉 ["Cleaning the MFP Scanner \(option\)" on page 191](#)

If document width cannot be recognized correctly after cleaning, open the Copy Settings menu, and then set the width of the document under **Width**.

👉 ["Large Copy / Large Scan menu" on page 174](#)

A document cannot be pulled out / A document is jammed

Open the cover of the MFP Scanner, and then remove the document.

Problem Solver

The following procedure shows how to remove the document.

- 1 Press the buttons on both sides of the cover to release the locks.

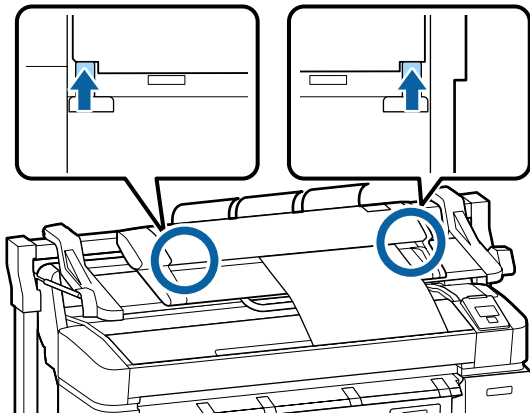

- 2 When the locks are released, the cover opens automatically, and you can remove the document.

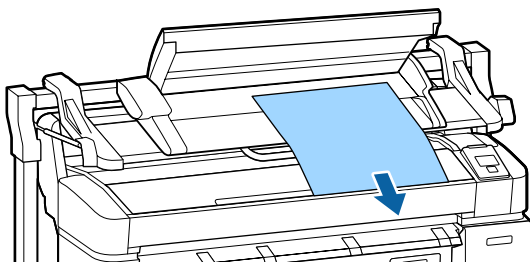

Black or white horizontal stripes or uneven colors appear in copied/ scanned images

- **The rollers of the MFP Scanner may be soiled.**
Turn off the printer and open the scanner cover, and then clean the rollers.
[🔗 "Cleaning the MFP Scanner \(option\)" on page 191](#)

- **The glass that covers the image sensor maybe soiled.**
Turn off the printer and open the scanner cover, and then inspect the top surface of the glass.
If the glass is stained, wipe it.
[🔗 "Cleaning the MFP Scanner \(option\)" on page 191](#)
If the glass surface is very scratched, contact your dealer or local Epson Support.

Calibration

If you cleaned the glass surface and rollers inside the MFP Scanner, but horizontal lines are shifted or there are uneven colors in the copy results or scanned images, use the following procedure to calibrate the scanner.

Use the calibration sheet included with the MFP Scanner for calibration.

- 1 Align the loading guide with the calibration sheet set position.

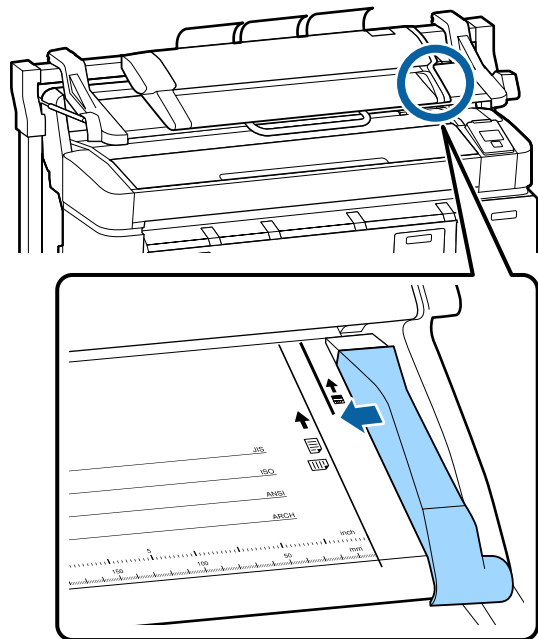

- 2 Align the right edge with the loading guide so that calibration sheet is loaded from the black side.

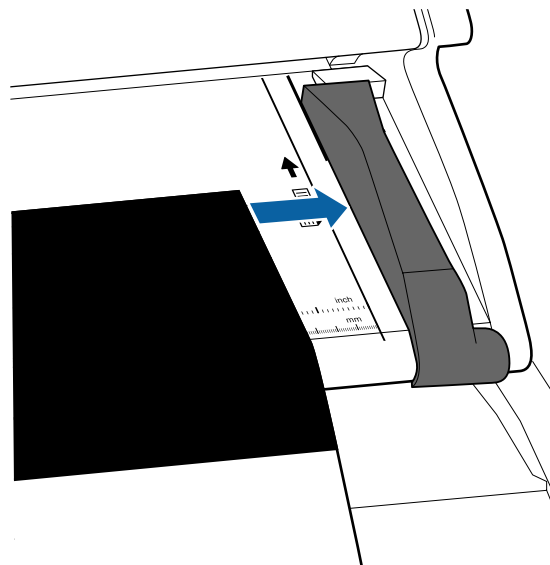

Problem Solver

- 3** Insert the calibration sheet horizontally until its edge touches the inner roller.

The calibration sheet is loaded automatically until the read start position.

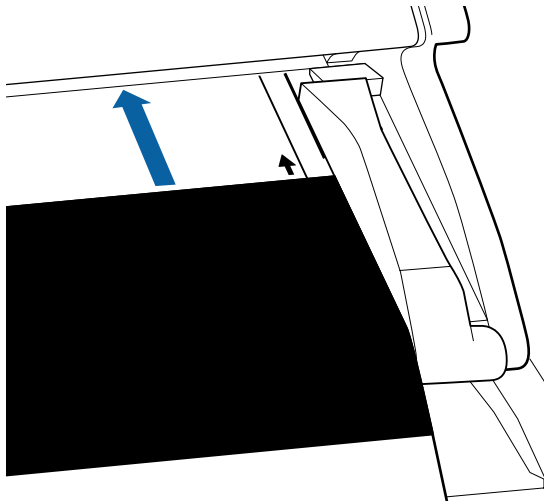

- 4** After the calibration sheet has been loaded, remove the loading guide.

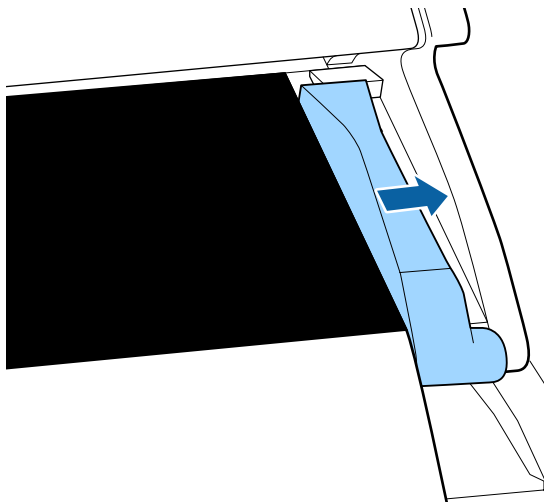

- 5** At Large copy/Large scan screen, use the ▼/▲ buttons to select **Scanner Maintenance** and press the OK button.
- 6** Use the ▼/▲ buttons to select **Calibration** and press the OK button.
- 7** If the OK button is pressed, calibration starts.

! **Important:**
Do not turn off the printer during calibration. If the printer turned off, the MFP Scanner may malfunction.

- 8** A message is displayed when calibration is complete. If you follow the message and press the OK button, the calibration sheet is ejected.

Note:
Store the calibration sheet so it does not become soiled or folded.

Feed Adjust (MFP Scanner)

If the print results and document length of copied/ scanned files do not match, use the following procedure to adjust document feeding. Differences in length may occur due to the paper type used for printing.

- 1** At Large copy/Large scan screen, use the ▼/▲ buttons to select **Scanner Maintenance** and press the OK button.
- 2** Use the ▼/▲ buttons to select **Feed Adjust** and press the OK button.
- 3** An adjustment setting screen will be displayed. Press the ▼/▲ buttons to display the target adjustment value, and then press the OK button.

The following section shows how the adjustment values are calculated.

Example) Document length: 50 cm, print result: 50.1 cm

$$50/50.1 \times 100 - 100 = -0.1996, \text{ rounded at the second decimal place}$$

Adjustment value: -0.2

- 4** After the adjustment value has been set, press the **II** button to exit.

Note:
The adjustment result is enabled until the next time the adjustment value is changed.

Appendix

Appendix

Options and Consumable Products



The following options and consumable products are available for use with your printer. (As of January, 2014)

For the latest information, see the Epson Web site.

Ink cartridges

SC-T7200D/SC-T7270D/SC-T7200/SC-T7270/SC-T5200D/ SC-T5270D/SC-T5200/SC-T5270/SC-T3200/SC-T3270				Explanation
Color	Capacity			
	700 ml	350 ml	110 ml	
Photo Black	T6941	T6931	T6921	Epson recommends the use of genuine Epson ink cartridges. Epson cannot guarantee the quality or reliability of non-genuine ink. The use of non-genuine ink may cause damage that is not covered by Epson's warranties, and under certain circumstances, may cause erratic printer behavior. Information about non-genuine ink levels may not be displayed, and use of non-genuine ink is recorded for possible use in service support.  "Replacing Ink Cartridges" on page 185
Cyan	T6942	T6932	T6922	
Magenta	T6943	T6933	T6923	
Yellow	T6944	T6934	T6924	
Matte Black	T6945	T6935	T6925	
SC-T7280D/SC-T7280/SC-T5280D/SC-T5280/SC-T3280				
Color	Capacity			
	700 ml	350 ml	110 ml	
Photo Black	T7081	T7071	T7061	
Cyan	T7082	T7072	T7062	
Magenta	T7083	T7073	T7063	
Yellow	T7084	T7074	T7064	
Matte Black	T7085	T7075	T7065	

Others

Product	Part number	Explanation
Epson Special Media	 "Epson Special Media Table" on page 212	
Maintenance Box	T6193	Replacement Maintenance Box for Maintenance Box which is at the end of its service life.  "Replacing Maintenance Boxes" on page 186
Auto Cutter Spare Blade	S902007	See the following section to replace the cutter.  "Replacing the Cutter" on page 187
Roll Adapter	C12C811401	This is the same as the roll adapter supplied with the printer.

Appendix

Product	Part number	Explanation
Roll Paper Belt	C12C890121	This holder keeps roll paper from unrolling after it is removed from the printer. ☞ "Removing Roll paper or Roll 1" on page 36
Hard Disk Unit	C12C848031	Use ☞ "Saving to and Reprinting on the Optional Hard Disk Unit" on page 69
Auto Take-up Reel Unit	C12C815321	For the SC-T7200 Series only. Cannot be connected to models other than the SC-T7200 Series. Be sure to use with the auto take-up reel unit attachment. The auto take-up reel unit can not be connected to the printer without the attachment. See the documentation supplied with the auto take-up reel unit for information on installation. Use ☞ "Using the Auto Take-up Reel Unit (SC-T7200 Series Only)" on page 53
Attachment for Auto Take-up Reel Unit	C12C815411	For the SC-T7200 Series only. Cannot be connected to models other than the SC-T7200 Series. This item is required when installing the auto take-up reel unit.
MFP Scanner	C12C891071	Can scan and copy documents up to 914 × 2,438 mm. When used with the optional hard disk unit or Adobe PostScript 3 Expansion Unit, it can save scanned data, send it by e-mail, and transfer it to shared folders.
MFP Scanner stand 44"	C12C844161	This dedicated stand is used to connect the MFP Scanner to the top of the printer. Select the width in accordance with a model you are using.
MFP Scanner stand 36"	C12C844151	
Adobe® PostScript® 3™ Expansion Unit	C12C891131	This unit allows you to use the printer as a PostScript printer. For information on using the unit, see the documentation supplied with the Adobe PostScript 3 Expansion Unit.
Stand(24")	C12C844171	For the SC-T3200 Series only. See the <i>Setup Guide</i> for assembly instructions.

Appendix

Supported Media

We recommend you use the following Epson special media for high-quality printing results.

Note:

For information about the media types and appropriate settings for printing on paper other than Epson special media or when using raster image processing (RIP) software, see the documentation supplied with the paper, or contact the dealer of the paper or the manufacturer of the RIP.

Epson Special Media Table

Item descriptions

Size: Describes the size for cut sheet media or the width for roll paper.

Borderless: Describes whether borderless printing is available.

Head Alignment: Describes availability of auto Head Alignment with option of Auto(Bi-D) or Auto(Uni-D).

Take-up: Describes available taking up direction when using optional Auto Take-up Reel Unit: "F" means Forward and "B" means Backward.

Enlarged: Describes availability of Enlarged Copy when connecting an A4/A3 size scanner to the printer.

Roll Paper

Premium Glossy Photo Paper (250)

Paper thickness: 0.27 mm Roll core size: 3 inches

ICC profile: EPSON SCT3000_5000_7000_Series Premium Glossy Photo Paper 250.icc

Size	Borderless	Head Alignment	Take-up		Enlarged
			F	B	
406mm/16"	✓	✓	✓	✓	-
610mm/24"					✓
914mm/36"*1					✓
1118mm/44"*2					✓

*1 SC-T3200 Series is not supported

*2 SC-T7200 Series/SC-T7200D Series only are supported

Premium Semigloss Photo Paper (250)

Paper thickness: 0.27 mm Roll core size: 3 inches

Appendix

ICC profile: EPSON SCT3000_5000_7000_Series Premium Semigloss Photo Paper 250.icc

Size	Borderless	Head Alignment	Take-up		Enlarged
			F	B	
406mm/16"	✓	✓	✓	✓	-
610mm/24"					✓
914mm/36"*1					
1118mm/44"*2					

*1 SC-T3200 Series is not supported

*2 SC-T7200 Series/SC-T7200D Series only are supported

Premium Luster Photo Paper (260)

Paper thickness: 0.27 mm Roll core size: 3 inches

ICC profile: EPSON SCT3000_5000_7000_Series Premium Luster Photo Paper 260.icc

Size	Borderless	Head Alignment	Take-up		Enlarged
			F	B	
254mm/10"	✓	✓	-	-	-
300mm/11.8"					
406mm/16"					
508mm/20"	-	-	✓	✓	✓
610mm/24"					
914mm/36"*1					
1118mm/44"*2					

*1 SC-T3200 Series is not supported

*2 SC-T7200 Series/SC-T7200D Series only are supported

Premium Semimatte Photo Paper (260)

Paper thickness: 0.27 mm Roll core size: 3 inches

ICC profile: EPSON SC-T3000_5000_7000_Series Premium Semimatte Photo Paper 260.icc

Appendix

Size	Borderless	Head Alignment	Take-up		Enlarged
			F	B	
406mm/16"	✓	✓	✓	✓	-
610mm/24"					
914mm/36"*1					
1118mm/44"*2					

*1 SC-T3200 Series is not supported

*2 SC-T7200 Series/SC-T7200D Series only are supported

Photo Paper Gloss 250

Paper thickness: 0.25 mm Roll core size: 3 inches

ICC profile: EPSON SCT3000_5000_7000_Series Photo Paper Gloss 250.icc

Size	Borderless	Head Alignment	Take-up		Enlarged
			F	B	
432mm/17"	✓	✓	✓	✓	✓
610mm/24"					
914mm/36"*1					
1118mm/44"*2					

*1 SC-T3200 Series is not supported

*2 SC-T7200 Series/SC-T7200D Series only are supported

Premium Glossy Photo Paper (170)

Paper thickness: 0.18 mm Roll core size: 2 inches

ICC profile: EPSON SCT3000_5000_7000_Series Premium Glossy Photo Paper 170.icc

Appendix

Size	Borderless	Head Alignment	Take-up		Enlarged
			F	B	
420mm(A2)	-				
610mm/24"	✓	✓	✓	✓	✓
914mm/36"*1					
1118mm/44"*2					

*1 SC-T3200 Series is not supported

*2 SC-T7200 Series/SC-T7200D Series only are supported

Premium Semigloss Photo Paper (170)

Paper thickness: 0.18 mm Roll core size: 2 inches

ICC profile: EPSON SCT3000_5000_7000_Series Premium Semigloss Photo Paper 170.icc

Size	Borderless	Head Alignment	Take-up		Enlarged
			F	B	
420mm(A2)	-				
610mm/24"	✓	✓	✓	✓	✓
914mm/36"*1					
1118mm/44"*2					

*1 SC-T3200 Series is not supported

*2 SC-T7200 Series/SC-T7200D Series only are supported

Enhanced Matte Paper

Paper thickness: 0.25 mm Roll core size: 3 inches

ICC profile: EPSON SCT3000_5000_7000_Series Enhanced and Archival Matte Paper.icc

Appendix

Size	Borderless	Head Alignment	Take-up		Enlarged
			F	B	
432mm/17"	✓*3	✓	✓	-	-
610mm/24"					
914mm/36"*1					
1118mm/44"*2					

*1 SC-T3200 Series is not supported

*2 SC-T7200 Series/SC-T7200D Series only are supported

*3 Borderless printing available, but borders may appear or print quality decline due to paper expanding or contracting.

Doubleweight Matte Paper

Paper thickness: 0.21 mm Roll core size: 2 inches

ICC profile: EPSON SCT3000_5000_7000_Series Doubleweight Matte Paper.icc

Size	Borderless	Head Alignment	Take-up		Enlarged
			F	B	
610mm/24"	✓	✓	✓*3	-	✓
914mm/36"*1					
1118mm/44"*2					

*1 SC-T3200 Series is not supported

*2 SC-T7200 Series/SC-T7200D Series only are supported

*3 Use the tensioner supplied with the optional auto take-up reel unit

Singleweight Matte Paper

Paper thickness: 0.15 mm Roll core size: 2 inches

ICC profile: EPSON SCT3000_5000_7000_Series Singleweight Matte Paper.icc

Appendix

Size	Borderless	Head Alignment	Take-up		Enlarged
			F	B	
432mm/17"	✓	-	✓ ^{*3}	-	✓
610mm/24"					
914mm/36" ^{*1}					
1118mm/44" ^{*2}					

*1 SC-T3200 Series is not supported

*2 SC-T7200 Series/SC-T7200D Series only are supported

*3 Use the tensioner supplied with the optional auto take-up reel unit

Enhanced Synthetic Paper

Paper thickness: 0.13 mm Roll core size: 2 inches

ICC profile: EPSON SCT3000_5000_7000_Series Enhanced Synthetic Paper.icc

Size	Borderless	Head Alignment	Take-up		Enlarged
			F	B	
610mm/24"	✓ ^{*2}	-	✓	✓	-
1118mm/44" ^{*1}					

*1 SC-T7200 Series/SC-T7200D Series only are supported

*2 Borderless printing available, but borders may appear or print quality decline due to paper expanding or contracting.

Enhanced Adhesive Synthetic Paper

Paper thickness: 0.18 mm Roll core size: 2 inches

ICC profile: EPSON SCT3000_5000_7000_Series Enhanced Adhesive Synthetic Paper.icc

Size	Borderless	Head Alignment	Take-up		Enlarged
			F	B	
610mm/24"	✓ ^{*2}	-	✓	✓	-
1118mm/44" ^{*1}					

*1 SC-T7200 Series/SC-T7200D Series only are supported

Appendix

- *2 Borderless printing available, but borders may appear or print quality decline due to paper expanding or contracting.

Cut sheet

Borderless printing with cut sheets can only be performed with no left and right margins.

Premium Glossy Photo Paper

Thickness: 0.27 mm

ICC Profile: EPSON SC-T3000_5000_7000_Series Premium Glossy Photo Paper.icc

Size	Borderless	Head Alignment	Enlarged*2
Super A3/B	✓*1	✓	-
A2	-		✓
US-C	✓*1		✓

- *1 Borderless printing available, but borders may appear or print quality decline due to paper expanding or contracting.

- *2 Load the cut sheet, and then perform a copy operation.

Premium Semigloss Photo Paper

Thickness: 0.27 mm

ICC Profile: EPSON SC-T3000_5000_7000_Series Premium Semigloss Photo Paper.icc

Size	Borderless	Head Alignment	Enlarged*2
Super A3/B	✓*1	✓	-
A2	-		✓
US-C	✓*1		✓

- *1 Borderless printing available, but borders may appear or print quality decline due to paper expanding or contracting.

- *2 Load the cut sheet, and then perform a copy operation.

Premium Luster Photo Paper

Thickness: 0.27 mm

ICC Profile: EPSON SC-T3000_5000_7000_Series Premium Luster Photo Paper.icc

Appendix

Size	Borderless	Head Alignment	Enlarged*2
Super B	✓*1	✓	-
A2	-		✓
US-C	✓*1		

*1 Borderless printing available, but borders may appear or print quality decline due to paper expanding or contracting.

*2 Load the cut sheet, and then perform a copy operation.

Archival Matte Paper/Enhanced Matte Paper

Thickness: 0.26 mm

ICC Profile: EPSON SC-T3000_5000_7000_Series Enhanced and Archival Matte Paper.icc

Size	Borderless	Head Alignment	Enlarged
Super A3/B	✓*1	✓	-
A2	-		
US-C	✓*1		

*1 Borderless printing available, but borders may appear or print quality decline due to paper expanding or contracting.

Photo Quality Inkjet Paper

Thickness: 0.12 mm

ICC Profile: EPSON SC-T3000_5000_7000_Series Photo Quality Ink Jet Paper.icc

Size	Borderless	Head Alignment	Enlarged
Super A3/B	✓*1	-	-
A2	-		
US-C	✓*1		

*1 Borderless printing available, but borders may appear or print quality decline due to paper expanding or contracting.

Enhanced Matte Posterboard

Thickness: 1.30 mm

Appendix

ICC Profile: EPSON SC-T3000_5000_7000_Series Enhanced Matte Poster Board.icc

Size	Borderless	Head Alignment	Enlarged
610 × 762 mm (24" × 30")	-	-	-
762 × 1016 mm (30" × 40") *1			

*1 SC-T3200 Series not supported

Appendix

Usable Commercially Available Paper Size

This printer supports the following paper specifications for non-Epson media.



Important:

- ❑ Do not use paper that is wrinkled, scuffed, torn, or dirty.
- ❑ Although plain paper and recycled paper manufactured by other companies can be loaded and fed in the printer as long as they meet the following specifications, Epson cannot guarantee the print quality.
- ❑ Although other paper types manufactured by other companies can be loaded in the printer as long as they meet the following specifications, Epson cannot guarantee the paper feeding and print quality.

Roll Paper

Paper Type	Plain paper and recycled paper
Roll core size	2 inch and 3 inch
Roll paper outer diameter	150 mm or less
Width	<p>SC-T7200 Series/SC-T7200D Series 254 mm (10 inches) to 1,118 mm (44 inches)</p> <p>SC-T5200 Series/SC-T5200D Series 254 mm (10 inches) to 914mm (36 inches)</p> <p>SC-T3200 Series 254 mm (10 inches) to 610mm (24 inches)</p>
Thickness	0.08 to 0.5 mm

Available width for borderless printing	254 mm/10 inch 300 mm/11.8 inch Super A3/B/329 mm 406 mm/16 inch 17 inch B2/515 mm A1/594 mm 610 mm/24 inch 728 mm A0/841 mm 914 mm/36 inch 1,030 mm 1,118 mm/44 inch
---	---

Cut sheet

Paper Type	Plain paper and recycled paper
Width	<p>SC-T7200 Series/SC-T7200D Series 210 mm (A4) to 1,118 mm (44 inches)</p> <p>SC-T5200 Series/SC-T5200D Series 210 mm (A4) to 914 mm (36 inches)</p> <p>SC-T3200 Series 210 mm (A4) to 610 mm (24 inches)</p>
Length	279.4 to 1,580 mm
Thickness	0.08 to 0.8 mm (Poster Board: 0.8 to 1.5 mm)
Available width for borderless printing	254 mm/10 inch 300 mm/11.8 inch Super A3/B/329 mm 406 mm/16 inch 17 inch B2/515 mm A1/594 mm 610 mm/24 inch 728 mm A0/841 mm 914 mm/36 inch 1030 mm 1118 mm/44 inch

Appendix

Before printing on non-Epson media

When using non-Epson media (Custom Paper), make the paper configuration according to the paper characteristics before printing. Settings are adjusted as follows.

- ❑ Select **Custom Paper Setting** in the printer Paper menu.

 [“Paper menu” on page 149](#)

- ❑ Save custom paper settings to the printer using EPSON LFP Remote Panel 2.
- ❑ Save custom paper settings created in the printer driver to the computer (Windows).

Save settings using the **Custom Settings** option in the **Advanced** tab.

 [“Adding Media Types” on page 128](#)

When the custom media types are selected both with the printer and in the printer driver **Media Type** menu, priority is given to printer driver settings.

- ❑ Adjusting Settings in the Printer Driver (Mac OS X)

From the Advanced screen, open Paper Configuration dialog and adjust settings as desired.

See the printer driver help for more details.

Detailed adjustments can be made to user media settings using the **Custom Paper Setting** option in the printer Paper menu.

Note:

- ❑ *Be sure to check the paper characteristics such as paper tension, ink fixating, or paper thickness before setting the custom paper. For the paper's characteristics, check the paper's documentation or with your local dealer.*
- ❑ *Test the print quality with this printer before purchasing a large amount of paper.*
- ❑ *If colors in printed images on the custom paper are uneven, use unidirectional printing. For unidirectional printing, select **Printer Settings** > **Print Quality** (Windows) or **Mode** (Mac OS X) > **Advanced Settings** and clear the **High Speed** check box.*
- ❑ *If you are using the SC-T7200D Series/SC-T5200D Series and printing with both Roll 1 and Roll 2, configure them individually by setting the print settings using the **Custom Paper Setting**, even when the paper is the same. If the Custom Paper Setting set by the conditions set in Roll 1 is applied to the same type of paper loaded in Roll 2, but the paper path, paper width, or other print conditions are different, printing will not be performed correctly.*

Appendix

Notes When Moving or Transporting the Printer

This section describes precaution when moving and transporting the product.

Notes When Moving the Printer

This section assumes that the product is being moved to another location on the same floor without traversing stairs, ramps, or lifts. See the following section for information on moving the printer between floors or to another building.

 [“Notes on Transporting” on page 224](#)



Caution:

Do not tilt the product more than 10 degrees forward or back while moving it. Failure to observe this precaution could result in the printer falling over, causing accidents.



Important:

Do not remove the ink cartridges. Failure to observe this precaution could cause the print head nozzles to dry out.

Getting Ready

- 1 Confirm that the printer is off.
- 2 Disconnect the power cords and all other cables.
- 3 Close the paper basket.
When the optional auto take-up reel unit is installed, remove any paper from it.

4

When the optional MFP stand is attached, pull up and fix the fall prevention fixture of the stand.

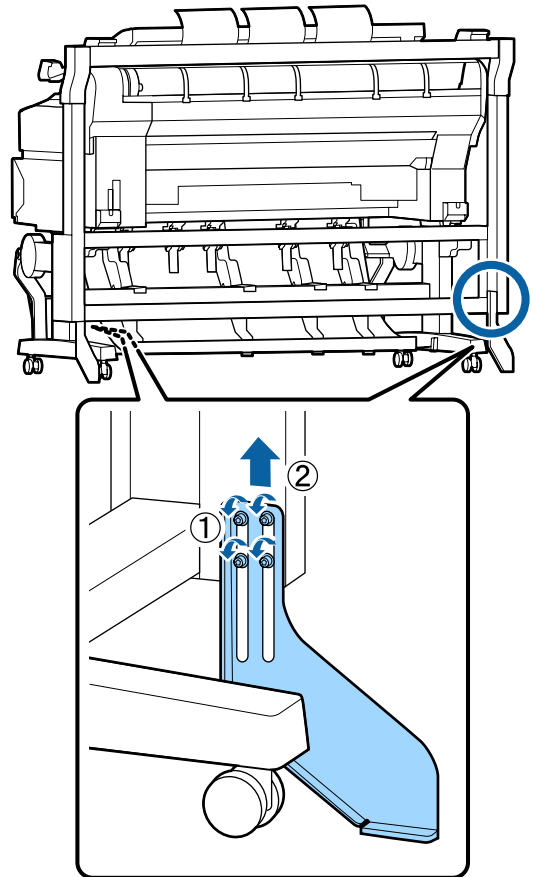

Important:

If the printer is moved with the fall prevention fixture lowered, the floor may be scratched.

5

Unlock the stand.

Release the locks of the casters on the left and right legs.

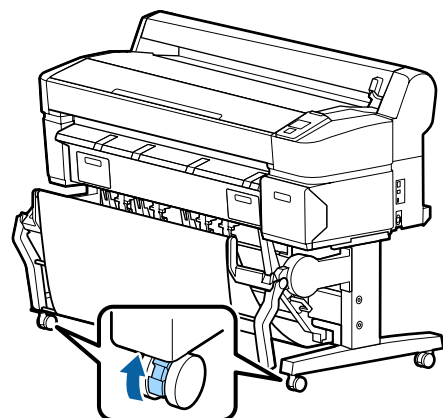

Appendix

6 Move the printer.

! Important:
Use the casters on the dedicated printer stand only to move the printer indoors a short distance over a level floor. They can not be used for transport.

Notes on Transporting

Make the following preparations in advance before transporting the printer.

- ❑ Turn off the printer and remove all cables.
- ❑ Remove any paper.
- ❑ Remove any optional components if they are installed.

To remove the optional components, see the *Setup guide* included with each of them, and then reverse the attachment procedure.

! Important:
When removing the MFP Scanner and stand, first attach the metal fittings and scratch-prevention sheet shown in the following illustration to the stand. After attaching the metal fittings, remove the MFP Scanner from the stand. If the order is incorrect, the stand will be damaged.

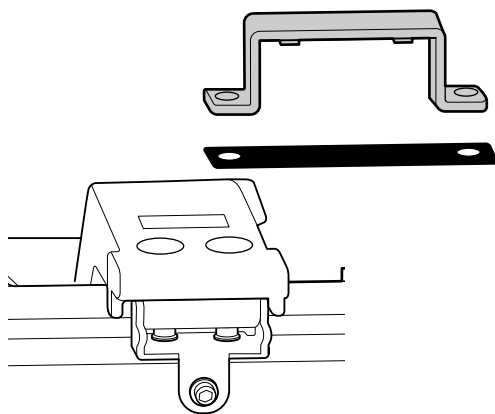

Furthermore, repack it using the original box and packing materials to protect it from shock and vibration.

! Caution:

- ❑ The printer is heavy. When you pack or move the printer, use two or more people for the SC-T3200 Series and four or more people for the SC-T7200 Series/SC-T7200D Series/SC-T5200 Series/SC-T5200D Series when carrying it.
- ❑ When you lift the printer, maintain a natural posture.
- ❑ When you lift the printer, place your hands at the locations indicated in the following illustration.

If you lift the printer while holding other sections, you may be injured. For example, you may drop the printer or your fingers may be pinched when lowering the printer.

When you move the printer while packaging it, place your hands at the positions in the illustration, and then lift.

SC-T7200 Series/SC-T7200D Series/SC-T5200 Series/SC-T5200D Series

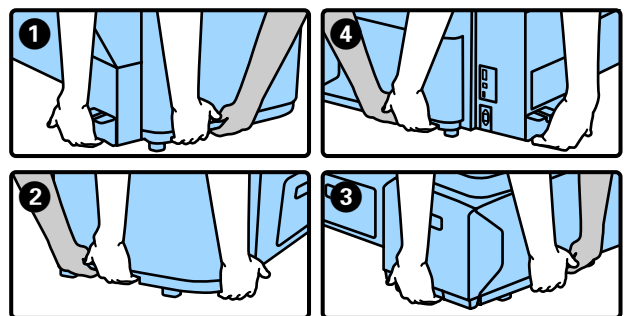
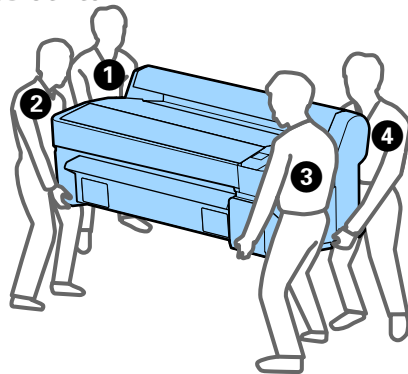

Appendix

SC-T3200 Series

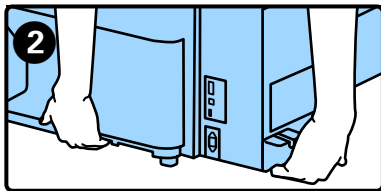
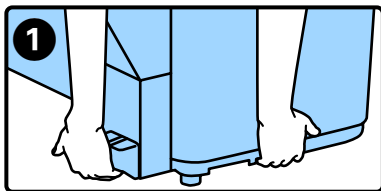
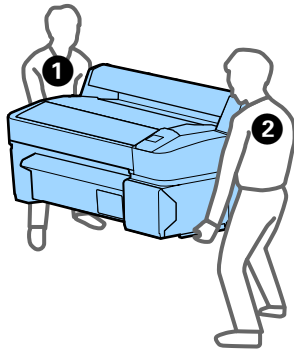

Important:

- ❑ Only hold the required area; otherwise, the printer may be damaged. Failure to observe this precaution could damage the printer.
- ❑ Move and transport the printer with ink cartridges installed. Do not remove the ink cartridges; otherwise, the nozzles may be clogged and make it impossible to print, or ink may leak.

Notes when reusing the printer

After moving or transporting, check if the print head is clogged before use.

[“Checking for clogged nozzles” on page 179](#)

System Requirements

System Requirements of the Printer Driver

The following chart shows the system requirements to install and use the printer driver included with this printer. For information on supported operating systems, see the Epson website.

Windows

Operating system	Windows XP/Windows XP x64 Windows Vista/Windows Vista x64 Windows 7/Windows 7 x64 Windows 8/Windows 8 x64 Windows 8.1/Windows 8.1 x64 Windows 10/Windows 10 x64 Windows Server 2003/Windows Server 2003 x64/Windows Server 2008/Windows Server 2008 x64/Windows Server 2008 R2/Windows Server 2012
CPU	Core 2 Duo 3.05 GHz or better
Memory	1 GB or more available memory
Available hard disk space	32 GB or more
Interface	Hi-Speed USB-Compatible with the USB 2.0 Specification. Ethernet 10BASE-T, 100BASE-TX/1000BASE-T*
Display resolution	SVGA (800 x 600) or higher resolution

* Use a shielded twisted-pair cable (Category 5e or higher).

Note:

When installing, you must log in as a user with an computer administrator account (a user belonging to the Administrators group).

Mac OS X

Operating system	Mac OS X 10.5.8 or later
CPU	Core 2 Duo 3.05 GHz or better
Memory	1 GB or more available memory

Appendix

Available hard disk space	32 GB or more
Display resolution	WXGA (1280 x 800) or higher resolution
Interface	Hi-Speed USB-Compatible with the USB 2.0 Specification. Ethernet 10BASE-T, 100BASE-TX/1000BASE-T*

* Use a shielded twisted-pair cable (Category 5e or higher).

System Requirements for Copy Manager

The following shows the system requirements to use Copy Manager.

Tablet terminal

Operating system	iOS 4.3 or later Android
------------------	-----------------------------

Windows

Operating system	Windows XP/Windows XP x64 Windows Vista/Windows Vista x64 Windows 7/Windows 7 x64 Windows 8/Windows 8 x64 Windows 8.1/Windows 8.1 x64 Windows 10/Windows 10 x64 Windows Server 2003/Windows Server 2003 x64/Windows Server 2008/Windows Server 2008 x64/Windows Server 2008 R2/Windows Server 2012
Recommended browser	Google Chrome/Safari
Display resolution	1024 x 768 or higher

Mac OS X

Operating system	Mac OS X 10.5.8 or later
Recommended browser	Safari
Display resolution	1024 x 768 or higher

Specifications Table

Printer Specifications	
Printing method	On-demand ink jet
Nozzle configuration	Black: 360 nozzles x 2 rows x 2 colors (Photo Black and Matte Black)
	Color: 360 nozzles x 2 rows x 3 colors (Yellow, Magenta, and Cyan)
Resolution (maximum)	2880x1440 dpi
Control code	ESC/P raster (undisclosed command) HP-GL/2, HP RTL*1
Media feed method	Friction feed
Built-in memory	1GB for Main
Network Functions	IPv4, IPv6, WSD, IPsec/access control, SSL communication, IEEE802.1X, SNMPv1/v2c/v3*2
Rated voltage	AC 100 to 240 V
Rated frequency	50/60 Hz
Rated current	1.0 to 0.5 A
Power consumption	
In use	SC-T7200 Series: Approximately 64 W SC-T5200 Series: Approximately 60 W SC-T3200 Series: Approximately 52 W SC-T7200D Series: Approximately 65 W SC-T5200D Series: Approximately 61 W
Ready mode	SC-T7200 Series/SC-T5200 Series/SC-T3200 Series: Approximately 16 W SC-T7200D Series/SC-T5200D Series: Approximately 17 W
Sleep mode	3.0 W or less
Power off	0.5 W or less

Appendix

Printer Specifications	
Temperature	<p>Operating: 10 to 35 °C (50 to 95°F)</p> <p>Storage (before unpacking): -20 to 60 °C (-4 to 140°F) (within 120 hours at 60 °C (140°F), within a month at 40 °C (104°F))</p> <p>Storage (after unpacking): -20 to 40 °C (-4 to 104 °F) (within a month at 40 °C (104 °F))</p>
Humidity	<p>Operating: 20 to 80% (without condensation)</p> <p>Storage (before unpacking): 5 to 85% (without condensation)</p> <p>Storage (after unpacking): 5 to 85% (without condensation)</p>

Printer Specifications	
<p>Operation temperature/humidity (when the hard disk unit or Adobe PostScript 3 Expansion Unit has not been connected)</p>	
<p>Operation temperature/humidity (when the hard disk unit or Adobe PostScript 3 Expansion Unit has been connected)</p>	
Dimension	<p>SC-T7200 Series: (W) 1608 x (D) 762^{*3} x (H) 1128 mm</p> <p>SC-T5200 Series: (W) 1405 x (D) 762^{*3} x (H) 1128 mm</p> <p>SC-T3200 Series: (W) 1050 x (D) 691 x (H) 613 mm (With optional Stand (24): (W) 1050 x (D) 762^{*3} x (H) 1117 mm)</p> <p>SC-T7200D Series: (W) 1608 x (D) 734^{*3} x (H) 1128 mm</p> <p>SC-T5200D Series: (W) 1405 x (D) 734^{*3} x (H) 1128 mm</p>

Appendix

Printer Specifications	
Weight*4	SC-T7200 Series: Approximately 92 kg SC-T5200 Series: Approximately 84 kg SC-T3200 Series: Approximately 54 kg (With optional Stand (24): Approximately 67 kg) SC-T7200D Series: Approximately 133 kg SC-T5200D Series: Approximately 118 kg

*1 For information on HP-GL/2 and HP RTL, see the Epson website.

*2 Configure SNMP from Remote Manager.
 ["How to use Remote Manager" on page 27](#)

*3 Paper basket/Large-capacity paper basket closed.

*4 Excluding ink cartridges.

Ink Specifications	
Type	Special ink cartridges
Pigment ink	Black: Photo Black, Matte Black Color: Yellow, Magenta, Cyan
Use by date	See the date printed on the package (at normal temperature)
Print quality guarantee expiry	1 year (when installed in printer)
Storage temperature	Uninstalled: -20 to 40 °C (within 4 days at -20 °C, a month at 40 °C) Installed in printer: -20 to 40 °C (within 4 days at -20 °C, a month at 40 °C) Transporting: -20 to 60 °C (within 4 days at -20 °C, a month at 40 °C, 72 hours at 60 °C)
Cartridge dimensions	700 ml: (W) 40 x (D) 305 x (H) 110 mm 350ml: (W) 40 x (D) 200 x (H) 110 mm 110ml: (W) 25 x (D) 200 x (H) 110 mm

 **Important:**

- We recommend that you remove and shake the installed ink cartridges once every three months to ensure print quality.
- The ink freezes if left at below -20°C for a long time. If it does freeze, leave it at room temperature (25°C) for at least four hours (without condensation).
- Do not refill the ink.

MFP Scanner specifications	
Read width	153 to 914.4 mm (36 inches)
Document	
Size (width)	153 to 965.2 mm (38 inches)
Size (length)	During copying 153 to 4614.9 mm (181.7 inches) During scanning JPEG/PDF (Color/gray): 153 mm to 16.6 m (at 100 dpi)*, 153 mm to 4.6 m (at 360 dpi)*, 153 mm to 2.7 m (at 600 dpi)* PDF (Monochrome binary value): 153 mm to 30.4 m TIFF: 153 mm to 30.4 m (Maximum file size 2 GB) * Differs by resolution.
Thickness	0.05 to 1.3 mm
Eject direction	Forward/backward (switchable)
Optical resolution	600dpi
Scanning method	Contact image sensor
Secondary scanning method	Document movement (sheet pass-through) method
Scan resolution	100, 200, 300, 360, 400, 600dpi
Scan file format	JPEG, PDF, TIFF
Copy resolution	
Reading	300 dpi; 600 dpi in Text/Line Drawing, Recycled Paper, and Fine modes
Writing	360dpi
Copy scaling	25 to 400%
Number of continuous copies	1 to 99 sheets

Appendix

MFP Scanner specifications	
Sensor	CIS
Light source	Dual LED (RGB)
Rated voltage	AC 100 to 240 V
Rated frequency	50 to 60 Hz
Rated current	2.5A
Power consumption	
In use	Approximately 55 W
Ready mode	Approximately 25 W
Sleep mode/ power off	0.5 W

Standards and Approvals

SC-T7200D Series/SC-T5200D Series

Safety	UL 60950-1	
	CSA C22.2 No.60950-1	
	Low Voltage Directive 2006/95/EC	EN 60950-1
EMC	FCC part 15 subpart B Class A	
	CAN/CSA-CEI/IEC CISPR 22 Class A	
	AS/NZS CISPR 22 Class A	
	EMC Directive 2004/108/EC	EN 55022 Class A
		EN 55024
		EN 61000-3-2
		EN 61000-3-3



Warning:

This is a class A product. In a domestic environment this product may cause radio interference in which case the user may be required to take adequate measures.

SC-T7200 Series/SC-T5200 Series/SC-T3200 Series

Safety	UL 60950-1	
	CAN/CSA C22.2 No.60950-1	
	Low Voltage Directive 2006/95/EC	EN 60950-1
EMC	FCC part 15 subpart B Class B	
	CAN/CSA-CEI/IEC CISPR 22 Class B	
	AS/NZS CISPR 22 Class B	
	EMC Directive 2004/108/EC	EN 55022 Class B
		EN 55024
		EN 61000-3-2
		EN 61000-3-3

Where To Get Help

Where To Get Help

Technical Support Web Site

Epson's Technical Support Web Site provides help with problems that cannot be solved using the troubleshooting information in your product documentation. If you have a Web browser and can connect to the Internet, access the site at:

<http://support.epson.net/>

If you need the latest drivers, FAQs, manuals, or other downloadables, access the site at:

<https://www.epson.com>

Then, select the support section of your local Epson Web site.

Contacting Epson Support

Before Contacting Epson

If your Epson product is not operating properly and you cannot solve the problem using the troubleshooting information in your product documentation, contact Epson support services for assistance. If Epson support for your area is not listed below, contact the dealer where you purchased your product.

Epson support will be able to help you much more quickly if you give them the following information:

- Product serial number
(The serial number label is usually on the back of the product.)
- Product model
- Product software version
(Click **About**, **Version Info**, or similar button in the product software.)
- Brand and model of your computer
- Your computer operating system name and version
- Names and versions of the software applications you normally use with your product

Where To Get Help

Help for Users in North America

Epson provides the technical support services listed below.

Internet Support

Visit Epson's support website at <https://epson.com/support> and select your product for solutions to common problems. You can download drivers and documentation, get FAQs and troubleshooting advice, or e-mail Epson with your questions.

Speak to a Support Representative

Dial: (562) 276-1300 (U.S.), or (905) 709-9475 (Canada), 6 am to 6 pm, Pacific Time, Monday through Friday. Days and hours of support are subject to change without notice. Toll or long distance charges may apply.

Before you call Epson for support, please have the following information ready:

- Product name
- Product serial number
- Proof of purchase (such as a store receipt) and date of purchase
- Computer configuration
- Description of the problem

Note:

For help using any other software on your system, see the documentation for that software for technical support information.

Purchase Supplies and Accessories

You can purchase genuine Epson ink cartridges, ribbon cartridges, paper, and accessories from an Epson authorized reseller. To find the nearest reseller, call 800-GO-EPSON (800-463-7766). Or you can purchase online at <http://www.epsonstore.com> (U.S. sales) or <http://www.epson.ca> (Canadian sales).

Help for Users in Europe

Check your **Pan-European Warranty Document** for information on how to contact Epson support.

Help for Users in Taiwan

Contacts for information, support, and services are:

World Wide Web (<https://www.epson.com.tw>)

Information on product specifications, drivers for download, and products enquiry are available.

Epson HelpDesk (Phone: +0800212873)

Our HelpDesk team can help you with the following over the phone:

- Sales enquiries and product information
- Product usage questions or problems
- Enquiries on repair service and warranty

Repair service center:

Telephone number	Fax number	Address
02-23416969	02-23417070	No.20, Beiping E. Rd., Zhongzheng Dist., Taipei City 100, Taiwan
02-27491234	02-27495955	1F., No.16, Sec. 5, Nanjing E. Rd., Songshan Dist., Taipei City 105, Taiwan
02-32340688	02-32340699	No.1, Ln. 359, Sec. 2, Zhongshan Rd., Zhonghe City, Taipei County 235, Taiwan
039-605007	039-600969	No.342-1, Guangrong Rd., Luodong Township, Yilan County 265, Taiwan
038-312966	038-312977	No.87, Guolian 2nd Rd., Hualien City, Hualien County 970, Taiwan

Where To Get Help

Telephone number	Fax number	Address
03-4393119	03-4396589	5F., No.2, Nandong Rd., Pingzhen City, Taoyuan County 32455, Taiwan (R.O.C.)
03-5325077	03-5320092	1F., No.9, Ln. 379, Sec. 1, Jingguo Rd., North Dist., Hsinchu City 300, Taiwan
04-23011502	04-23011503	3F., No.30, Dahe Rd., West Dist., Taichung City 40341, Taiwan (R.O.C.)
04-23805000	04-23806000	No.530, Sec. 4, Henan Rd., Nantun Dist., Taichung City 408, Taiwan
05-2784222	05-2784555	No.463, Zhongxiao Rd., East Dist., Chiayi City 600, Taiwan
06-2221666	06-2112555	No.141, Gongyuan N. Rd., North Dist., Tainan City 704, Taiwan
07-5520918	07-5540926	1F., No.337, Minghua Rd., Gushan Dist., Kaohsiung City 804, Taiwan
07-3222445	07-3218085	No.51, Shandong St., Sanmin Dist., Kaohsiung City 807, Taiwan
08-7344771	08-7344802	1F., No.113, Shengli Rd., Pingtung City, Pingtung County 900, Taiwan

Help for Users in Australia

Epson Australia wishes to provide you with a high level of customer service. In addition to your product documentation, we provide the following sources for obtaining information:

Your Dealer

Don't forget that your dealer can often help identify and resolve problems. The dealer should always be the first call for advise on problems; they can often solve problems quickly and easily as well as give advise on the next step to take.

Internet URL

<https://www.epson.com.au>

Access the Epson Australia World Wide Web pages. Worth taking your modem here for the occasional surf! The site provides a download area for drivers, Epson contact points, new product information and technical support (e-mail).

Epson Helpdesk

Epson Helpdesk is provided as a final backup to make sure our clients have access to advice. Operators on the Helpdesk can aid you in installing, configuring and operating your Epson product. Our Pre-sales Helpdesk staff can provide literature on new Epson products and advise where the nearest dealer or service agent is located. Many types of queries are answered here.

The Helpdesk numbers are:

Phone: 1300 361 054

Fax: (02) 8899 3789

We encourage you to have all the relevant information on hand when you ring. The more information you prepare, the faster we can help solve the problem. This information includes your Epson product documentation, type of computer, operating system, application programs, and any information you feel is required.

Help for Users in Singapore

Sources of information, support, and services available from Epson Singapore are:

Where To Get Help

World Wide Web

(<https://www.epson.com.sg>)

Information on product specifications, drivers for download, Frequently Asked Questions (FAQ), Sales Enquiries, and Technical Support via e-mail are available.

Epson HelpDesk

(Phone: (65) 6586 3111)

Our HelpDesk team can help you with the following over the phone:

- Sales enquiries and product information
- Product usage questions or problems
- Enquiries on repair service and warranty

Help for Users in Thailand

Contacts for information, support, and services are:

World Wide Web

(<http://www.epson.co.th>)

Information on product specifications, drivers for download, Frequently Asked Questions (FAQ), and e-mail are available.

Epson Hotline

(Phone: (66) 2685 -9899)

Our Hotline team can help you with the following over the phone:

- Sales enquiries and product information
- Product usage questions or problems
- Enquiries on repair service and warranty

Help for Users in Vietnam

Contacts for information, support, and services are:

Epson Hotline (Phone): 84-8-823-9239

Service Center: 80 Truong Dinh Street,
District 1, Hochiminh City
Vietnam

Help for Users in Indonesia

Contacts for information, support, and services are:

World Wide Web

(<http://www.epson.co.id>)

- Information on product specifications, drivers for download
- Frequently Asked Questions (FAQ), Sales Enquiries, questions through e-mail

Epson Hotline

- Sales enquiries and product information
- Technical support

Phone (62) 21-572 4350

Fax (62) 21-572 4357

Epson Service Center

Jakarta Mangga Dua Mall 3rd floor No 3A/B
Jl. Arteri Mangga Dua,
Jakarta

Phone/Fax: (62) 21-62301104

Bandung Lippo Center 8th floor
Jl. Gatot Subroto No.2
Bandung

Phone/Fax: (62) 22-7303766

Surabaya Hitech Mall It IIB No. 12
Jl. Kusuma Bangsa 116 – 118
Surabaya

Phone: (62) 31-5355035

Fax: (62)31-5477837

Where To Get Help

Yogyakarta	Hotel Natour Garuda Jl. Malioboro No. 60 Yogyakarta
	Phone: (62) 274-565478
Medan	Wisma HSBC 4th floor Jl. Diponegoro No. 11 Medan
	Phone/Fax: (62) 61-4516173
Makassar	MTC Karebosi Lt. III Kav. P7-8 Jl. Ahmad Yani No.49 Makassar
	Phone: (62)411-350147/411-350148

Help for Users in Hong Kong

To obtain technical support as well as other after-sales services, users are welcome to contact Epson Hong Kong Limited.

Internet Home Page

Epson Hong Kong has established a local home page in both Chinese and English on the Internet to provide users with the following information:

- Product information
- Answers to Frequently Asked Questions (FAQs)
- Latest versions of Epson product drivers

Users can access our World Wide Web home page at:

<https://www.epson.com.hk>

Technical Support Hotline

You can also contact our technical staff at the following telephone and fax numbers:

Phone: (852) 2827-8911

Fax: (852) 2827-4383

Help for Users in Malaysia

Contacts for information, support, and services are:

World Wide Web

[\(https://www.epson.com.my\)](https://www.epson.com.my)

- Information on product specifications, drivers for download
- Frequently Asked Questions (FAQ), Sales Enquiries, questions through e-mail

Epson Trading (M) Sdn. Bhd.

Head Office.

Phone: 603-56288288

Fax: 603-56288388/399

Epson Helpdesk

- Sales enquiries and product information (Infoline)

Phone: 603-56288222

- Enquiries on repair services & warranty, product usage and technical support (Techline)

Phone: 603-56288333

Help for Users in India

Contacts for information, support, and services are:

World Wide Web

[\(http://www.epson.co.in\)](http://www.epson.co.in)

Information on product specifications, drivers for download, and products enquiry are available.

Epson India Head Office - Bangalore

Phone: 080-30515000

Fax: 30515005

Where To Get Help

Epson India Regional Offices:

Location	Telephone number	Fax number
Mumbai	022-28261515 / 16/17	022-28257287
Delhi	011-30615000	011-30615005
Chennai	044-30277500	044-30277575
Kolkata	033-22831589 / 90	033-22831591
Hyderabad	040-66331738/ 39	040-66328633
Cochin	0484-2357950	0484-2357950
Coimbatore	0422-2380002	NA
Pune	020-30286000 / 30286001 /30286002	020-30286000
Ahmedabad	079-26407176 / 77	079-26407347

Helpline

For Service, Product info or to order a cartridge - 18004250011 (9AM - 9PM) - This is a Toll-free number.

For Service (CDMA & Mobile Users) - 3900 1600 (9AM - 6PM) Prefix local STD code

Help for Users in the Philippines

To obtain technical support as well as other after sales services, users are welcome to contact the Epson Philippines Corporation at the telephone and fax numbers and e-mail address below:

Trunk Line: (63-2) 706 2609

Fax: (63-2) 706 2665

Helpdesk
Direct Line: (63-2) 706 2625

E-mail: epchelpdesk@epc.epson.com.ph

World Wide Web

(<https://www.epson.com.ph>)

Information on product specifications, drivers for download, Frequently Asked Questions (FAQ), and E-mail Enquiries are available.

Toll-Free No. 1800-1069-EPSON(37766)

Our Hotline team can help you with the following over the phone:

- Sales enquiries and product information
- Product usage questions or problems
- Enquiries on repair service and warranty

Software License Terms

Software License Terms

OPEN SOURCE SOFTWARE LICENSE

- 1) This printer product includes open source software programs listed in Section 5) according to the license terms of each open source software program.
- 2) We provide the source code of the GPL Programs, LGPL Programs, Apache License Program and ncftp license Program (each is defined in Section 5) until five (5) years after the discontinuation of same model of this printer product. If you desire to receive the source code above, please see the "Contacting Epson Support" in the User's Guide, and contact the customer support of your region. You shall comply with the license terms of each open source software program.
- 3) The open source software programs are WITHOUT ANY WARRANTY; without even the implied warranty of MERCHANTABILITY AND FITNESS FOR A PARTICULAR PURPOSE. See the license agreements of each open source software program for more details, which are described on \Manual\DATA\EN\oss.pdf in the Software Disc.
- 4) The license terms of each open source software program are described on \Manual\DATA\EN\oss.pdf in the Software Disc.
- 5) The list of open source software programs which this printer product includes are as follows.

GNU GPL

This printer product includes the open source software programs which apply the GNU General Public License Version 2 or later version ("GPL Programs").

The list of GPL Programs:

linux-2.6.35-arm1-epson12
 busybox-1.17.4
 ethtool-2.6.35
 e2fsprogs-1.41.14
 scrub-2.4
 smartmontools-5.40
 WPA Supplicant 0.7.3
 Shred(Coreutils v8.23)

GNU Lesser GPL

This printer product includes the open source software programs which apply the GNU Lesser General Public License Version 2 or later version ("Lesser GPL Programs").

The list of LGPL Programs:

uclibc-0.9.32
 libusb-1.0.8
 libiConv-1.14

Apache License

Software License Terms

This printer product includes the open source software program “Bonjour” which apply the Apache License Version2.0 (“Apache License Program”).

Bonjour License

This printer product includes the open source software program “Bonjour” which applies the terms and conditions provided by owner of the copyright to the “Bonjour”.

Net-SNMP license

This printer product includes the open source software program “Net-SNMP” which applies the terms and conditions provided by owner of the copyright to the “Net-SNMP”.

BSD License (Berkeley Software Distribution License)

This printer product includes the open source software program which apply the Berkeley Software Distribution License (“BSD Program”).

The list of BSD Licence Programs:

busybox-1.17.4
WPA Supplicant 0.7.3

Sun RPC License

This printer product includes the open source software program “busybox-1.17.4” which apply the Sun RPC License (“Sun RPC Program”).

ncftp license

This printer product includes the open source software program “ncftp-3.2.4” which applies the terms and conditions provided by owner of the copyright to the “ncftp”.

e2fsprogs license

This printer product includes the open source software program “e2fsprogs-1.41.14” which applies the terms and conditions provided by owner of the copyright to the “e2fsprogs”.

MIT license

This printer product includes the open source software program “jQuery v1.8.2” which apply the MIT License.

OpenSSL License/Original SSLeay License

This printer product includes the open source software program “OpenSSL toolkit” which applies the license terms of OpenSSL License and Original SSLeay License.