

**SC-P9000 Series**

**SC-P7000 Series**

**SC-P8000 Series**

**SC-P6000 Series**

# **User's Guide**

---

## Copyrights and Trademarks

---

# Copyrights and Trademarks

No part of this publication may be reproduced, stored in a retrieval system, or transmitted in any form or by any means, electronic, mechanical, photocopying, recording, or otherwise, without the prior written permission of Seiko Epson Corporation. The information contained herein is designed only for use with this Epson printer. Epson is not responsible for any use of this information as applied to other printers.

Neither Seiko Epson Corporation nor its affiliates shall be liable to the purchaser of this product or third parties for damages, losses, costs, or expenses incurred by the purchaser or third parties as a result of accident, misuse, or abuse of this product or unauthorized modifications, repairs, or alterations to this product, or (excluding the U.S.) failure to strictly comply with Seiko Epson Corporation's operating and maintenance instructions.

Seiko Epson Corporation shall not be liable for any damages or problems arising from the use of any options or any consumable products other than those designated as Original Epson Products or Epson Approved Products by Seiko Epson Corporation.

Seiko Epson Corporation shall not be held liable for any damage resulting from electromagnetic interference that occurs from the use of any interface cables other than those designated as Epson Approved Products by Seiko Epson Corporation.

EPSON®, Epson UltraChrome®, EPSON EXCEED YOUR VISION, EXCEED YOUR VISION and their logos are registered trademarks or trademarks of Seiko Epson Corporation.

Microsoft®, Windows®, Windows Vista® and PowerPoint® are registered trademarks of Microsoft Corporation.

Apple®, Macintosh®, and Mac OS® are registered trademarks of Apple Inc.

Intel® is a registered trademark of Intel Corporation.

PowerPC® is a registered trademark of International Business Machines Corporation.

Adobe®, Photoshop®, Lightroom®, and Adobe® RGB (1998) are either registered trademarks or trademarks of Adobe Systems Incorporated in the United States and/or other countries.

*General Notice: Other product names used herein are for identification purposes only and may be trademarks of their respective owners. Epson disclaims any and all rights in those marks.*

© 2015 Seiko Epson Corporation. All rights reserved.

**Contents**

**Contents**

**Copyrights and Trademarks**

**Introduction**

Important Safety Instructions. . . . . 6

    The symbols on the product . . . . . 6

    When choosing a place for this product. . . . . 6

    When setting up this product. . . . . 6

    When using this product. . . . . 7

    When handling the ink cartridges. . . . . 7

Note on this Guide. . . . . 7

    Meaning of Symbols. . . . . 7

    Illustrations. . . . . 7

    Operating System Versions. . . . . 7

Printer Parts. . . . . 9

    Front. . . . . 9

    Back. . . . . 10

    Roll paper adapter. . . . . 12

    Control panel. . . . . 12

    Screen View. . . . . 14

Features. . . . . 16

    Realizing High Resolution. . . . . 16

    Superior Ease of Use. . . . . 17

    Various Options. . . . . 17

Notes on Usage and Storage. . . . . 18

    Installation space. . . . . 18

    Notes when using the printer. . . . . 18

    Notes when not using the printer. . . . . 19

    Notes on handling ink cartridges. . . . . 19

    Notes on handling paper. . . . . 20

Introducing the Software. . . . . 22

    Software on the Disc. . . . . 22

    Software on the Website. . . . . 25

    Remote Manager. . . . . 26

Starting and Closing Software. . . . . 26

    Starting. . . . . 26

    Closing. . . . . 26

Uninstalling Software. . . . . 27

    Windows. . . . . 27

    Mac OS X. . . . . 27

**Basic Operations**

Loading and Removing the Roll Paper. . . . . 28

    Loading Roll Paper. . . . . 28

    Cutting the roll paper. . . . . 31

    Removing Roll Paper. . . . . 32

Loading and Removing Cut Sheets. . . . . 34

    Loading Cut Sheets A3 Size or Larger and  
    Poster Board. . . . . 34

    Loading Cut Sheets Smaller than A3 Size. . . . . 36

    Removing Cut Sheets. . . . . 36

Checking and Setting the Paper Type. . . . . 37

    Checking the Paper Type. . . . . 37

    Paper Type Settings. . . . . 38

Using the Paper Basket. . . . . 39

    Ejecting Paper to the Rear. . . . . 39

    Ejecting Paper to the Front. . . . . 41

    Storing. . . . . 42

Using the Auto Take-up Reel Unit (SC-P9000  
Series/SC-P8000 Series Only). . . . . 43

    Using the Control Panel. . . . . 43

    Attaching the Paper. . . . . 44

    Removing Paper from the Auto Take-up Reel  
    Unit. . . . . 47

Basic Printing Methods. . . . . 48

    Printing (Windows). . . . . 48

    Printing (Mac OS X). . . . . 49

    Canceling Printing (Windows). . . . . 51

    Canceling Printing (Mac OS X). . . . . 52

    Canceling Printing (from the Printer). . . . . 52

Printable area. . . . . 52

    Roll Paper Printable Area. . . . . 52

    Cut Sheets Printable Area. . . . . 53

Changing the Type of Black Ink. . . . . 54

    Switching Automatically. . . . . 54

    Switching Manually. . . . . 55

Turning Off the Power Using Power Off Timer  
. . . . . 56

**Using the Optional Hard Disk Unit**

Function Summary. . . . . 57

    Extended functions. . . . . 57

    Print Job Management. . . . . 57

    Data on a Hard Disk. . . . . 58

Saving Print Jobs. . . . . 58

Viewing and Printing Saved Print Jobs. . . . . 59

**Using the Printer Driver(Windows)**

Displaying the Settings Screen. . . . . 61

    With the Start button. . . . . 61

**Contents**

Displaying Help. . . . . 62  
 Click the Help Button to Display. . . . . 62  
 Right-click on the item you want to check and display. . . . . 62  
 Customizing the Printer Driver. . . . . 63  
 Saving various settings as your Select Settings . . . . . 63  
 Adding a Paper Type . . . . . 63  
 Rearranging display items. . . . . 65  
 Summary of the Utility Tab. . . . . 66

**Using the Printer Driver(Mac OS X)**

Displaying the Settings Screen. . . . . 68  
 Displaying Help. . . . . 68  
 Using Presets. . . . . 68  
 Saving to Presets. . . . . 68  
 Deleting from Presets. . . . . 69  
 Using Epson Printer Utility 4. . . . . 69  
 Starting Epson Printer Utility 4. . . . . 69  
 Epson Printer Utility 4 Functions. . . . . 69

**Printing Varieties**

Auto Color Adjustment by PhotoEnhance (Windows Only). . . . . 71  
 Correct color and print. . . . . 72  
 Printing Black and White Photos. . . . . 75  
 Borderless Printing. . . . . 78  
 Types of Borderless Printing Methods. . . . . 78  
 Supported Paper. . . . . 78  
 About Roll Paper Cutting. . . . . 79  
 Setting Procedures for Printing. . . . . 80  
 Enlarged/Reduced Printing. . . . . 82  
 Fit to Page/Scale to fit paper size. . . . . 83  
 Fit to Roll Paper Width(Windows Only). . . . . 84  
 Custom Scale Setting. . . . . 84  
 Multi-Page Printing. . . . . 86  
 Poster Printing (Enlarge to cover several sheets and print - Windows only). . . . . 88  
 Setting Procedures for Printing. . . . . 88  
 Joining the output paper together. . . . . 90  
 Printing at Non-Standard Sizes. . . . . 93  
 Banner printing (on roll paper). . . . . 96  
 Layout Manager(Windows Only). . . . . 98  
 Setting Procedures for Printing. . . . . 98  
 Saving and Recalling Settings. . . . . 100

**Color Management Printing**

About Color Management. . . . . 101  
 Color Management Print Settings. . . . . 101  
 Setting profiles. . . . . 102  
 Setting color management with the applications . . . . . 102  
 Setting color management with the printer driver . . . . . 104  
 Color management printing by Host ICM (Windows). . . . . 104  
 Color management printing by ColorSync (Mac OS X). . . . . 105  
 Color management printing by Driver ICM(Windows Only). . . . . 105

**Using the Control Panel Menu**

Menu Operations. . . . . 108  
 Menu List. . . . . 109  
 Maintenance menu. . . . . 109  
 Print Queues menu. . . . . 109  
 Paper menu. . . . . 110  
 Printer Setup Menu. . . . . 111  
 Printer Status Menu. . . . . 111  
 Option Setup Menu. . . . . 112  
 Network Setup Menu. . . . . 112  
 Preferences Menu. . . . . 113  
 Administrator Menu. . . . . 113  
 Menu Descriptions. . . . . 114  
 Maintenance. . . . . 114  
 Print Queues. . . . . 115  
 Paper. . . . . 116  
 Printer Setup. . . . . 120  
 Printer Status. . . . . 121  
 Option Setup. . . . . 122  
 Network Setup. . . . . 122  
 Preferences. . . . . 123  
 Administrator Menu. . . . . 123

**Maintenance**

Print Head Maintenance. . . . . 125  
 Maintenance Operations. . . . . 125  
 Checking for clogged nozzles. . . . . 126  
 Cleaning the print head. . . . . 127  
 Adjusting print misalignments (Head Alignment). . . . . 129  
 Replacing Consumables. . . . . 133  
 Replacing Ink Cartridges. . . . . 133  
 Replacing Maintenance Boxes. . . . . 134

## Contents

Replacing the Cutter. . . . .	135
Cleaning the Printer. . . . .	137
Cleaning the outside. . . . .	137
Cleaning the inside. . . . .	137

### **Problem Solver**

What to do When a Message is Displayed. . . . .	139
SpectroProofer Error. . . . .	142
When a Maintenance Call/Service Call Occurs. . . . .	143
Troubleshooting. . . . .	145
You cannot print (because the printer does not work). . . . .	145
The printer sounds like it is printing, but nothing prints. . . . .	147
The prints are not what you expected. . . . .	147
Feeding or ejecting problems. . . . .	150
Others. . . . .	153

### **Appendix**

Options and Consumable Products. . . . .	156
Epson Special Media. . . . .	156
Ink cartridges. . . . .	156
Others. . . . .	158
Supported Media. . . . .	159
Epson Special Media Table. . . . .	159
Supported Commercially Available Paper. . . . .	176
Before Printing on Commercially Available Paper. . . . .	177
Notes When Moving or Transporting the Printer . . . . .	180
Notes When Moving the Printer. . . . .	180
Notes on Transporting. . . . .	180
Notes when reusing the printer. . . . .	181
System Requirements. . . . .	182
System Requirements of the Printer Driver. . . . .	182
Specifications Table. . . . .	183
Information of EU Declaration of Conformity . . . . .	184

### **Where To Get Help**

Technical Support Web Site. . . . .	186
Contacting Epson Support. . . . .	186
Before Contacting Epson. . . . .	186
Help for Users in North America. . . . .	187
Help for Users in Europe. . . . .	187
Help for Users in Australia. . . . .	187
Help for Users in Singapore. . . . .	188

Help for Users in Thailand. . . . .	188
Help for Users in Vietnam. . . . .	188
Help for Users in Indonesia. . . . .	188
Help for Users in Hong Kong. . . . .	189
Help for Users in Malaysia. . . . .	189
Help for Users in India. . . . .	189
Help for Users in the Philippines. . . . .	190

### **Software License Terms**

OPEN SOURCE SOFTWARE LICENSE. . . . .	191
Bonjour. . . . .	192
Other Software Licenses. . . . .	197
Info-ZIP copyright and license. . . . .	197

## Introduction

# Introduction

## Important Safety Instructions

Read all of these instructions before using the printer. Also be sure to follow all warnings and instructions marked on the printer.

### The symbols on the product

The symbols on this Epson product are used in order to ensure safety and proper use of the product and to prevent danger to customers and other persons, and property damage.

The symbols indicate the meaning below. Be sure that you completely understand the meaning of symbols on this product before using it.



Stand-by

### When choosing a place for this product

- Place this product on a flat, stable surface that is larger than this product. This product will not operate properly if it is tilted or at an angle.
- Avoid places subject to rapid changes in temperature and humidity. Also keep it away from direct sunlight, strong light, or heat sources.
- Avoid places subject to shocks and vibrations.
- Keep this product away from dusty areas.
- Place this product near a wall outlet where the plug can be easily unplugged.

### When setting up this product

- Do not block or cover the openings in this product's cabinet.

- Do not insert objects through the slots. Take care not to spill liquid on this product.
- This product's power cord is for use with this product only. Use with other equipment may result in fire or electric shock.
- Connect all equipment to properly grounded power outlets. Avoid using outlets on the same circuit as copiers or air control systems that regularly switch on and off.
- Avoid electrical outlets controlled by wall switches or automatic timers.
- Keep the entire computer system away from potential sources of electromagnetic interference, such as loudspeakers or the base units of cordless telephones.
- Use only the type of power source indicated on the product's label.
- Use only the power cord that comes with this product. Use of another cord may result in fire or electric shock.
- Do not use a damaged or frayed power cord.
- If you use an extension cord with this product, make sure the total ampere rating of the devices plugged into the extension cord does not exceed the cord's ampere rating. Also, make sure the total ampere rating of all devices plugged into the wall outlet does not exceed the wall outlet's ampere rating.
- Do not attempt to service this product yourself.
- Unplug this product and refer servicing to qualified service personnel under the following conditions: The power cord or plug is damaged; liquid has entered the product; the product has been dropped or the cabinet damaged; the product does not operate normally or exhibits a distinct change in performance.
- If you plan to use the printer in Germany, observe the following:  
To provide adequate short-circuit protection and over-current protection for this printer, the building installation must be protected by a 10 or 16 amp circuit breaker.

## Introduction

- ❑ If damage occurs to the plug, replace the cord set or consult a qualified electrician. If there are fuses in the plug, make sure you replace them with fuses of the correct size and rating.

---

### When using this product

- ❑ Do not put your hand inside this product or touch the ink cartridges during printing.
- ❑ Do not move the print heads by hand; otherwise you may damage this product.
- ❑ Always turn the product off using the Power button on the control panel. When this button is pressed, the Power light flashes briefly then goes off. Do not unplug the power cord or turn off the product until the Power light stops flashing.

---

### When handling the ink cartridges



- ❑ Keep ink cartridges out of the reach of children and do not drink.
- ❑ If ink gets on your skin, wash it off with soap and water. If it gets in your eyes, flush them immediately with water.
- ❑ Before installing the new ink cartridge in the printer, shake it back and forth horizontally in five centimeter movements about 15 times within five seconds.
- ❑ Use the ink cartridge before the date printed on its package.
- ❑ Use up the ink cartridge within six months of installation for best results.
- ❑ Do not dismantle the ink cartridges or try to refill them. This could damage the print head.
- ❑ Do not touch the IC chip on the side of the cartridge. This may affect normal operation and printing.
- ❑ The IC chip on this ink cartridge retains a variety of cartridge-related information, such as the ink cartridge status, so that the cartridge may be removed and reinserted freely. However, each time the cartridge is inserted, some ink is consumed because the printer automatically performs a reliability check.

- ❑ If you remove an ink cartridge for later use, protect the ink supply area from dirt and dust, and store it in the same environment as this product. Note that there is a valve in the ink supply port, making covers or plugs unnecessary, but care is needed to prevent the ink from staining items that the cartridge touches. Do not touch the ink supply port or surrounding area.

## Note on this Guide

---

### Meaning of Symbols

 <b>Warning:</b>	Warnings must be followed to avoid serious bodily injury.
 <b>Caution:</b>	Cautions must be followed to avoid damage to this product or bodily injury.
 <b>Important:</b>	Important contains important information on the operation of this product.
<b>Note:</b>	Notes contain useful or additional information on the operation of this product.

---

### Illustrations

Unless otherwise noted, the illustrations in this documentation show the SC-P9000 Series.

Unless otherwise noted, the computer screenshots show the violet inkset being used with the SC-P9000 Series.

---

### Operating System Versions

In this documentation, the following abbreviations are used.

**Windows refers to Windows 8.1, 8, 7, Vista and XP.**

- ❑ Windows 8.1 refers to Windows 8.1, Windows 8.1 Pro, and Windows 8.1 Enterprise.

## Introduction

- ❑ Windows 8 refers to Windows 8, Windows 8 Pro, and Windows 8 Enterprise.
- ❑ Windows 7 refers to Windows 7 Home Basic, Windows 7 Home Premium, Windows 7 Professional, and Windows 7 Ultimate.
- ❑ Windows Vista refers to Windows Vista Home Basic Edition, Windows Vista Home Premium Edition, Windows Vista Business Edition, Windows Vista Enterprise Edition, and Windows Vista Ultimate Edition.
- ❑ Windows XP refers to Windows XP Home Edition, Windows XP Professional x64 Edition, and Windows XP Professional.
- ❑ Windows Server 2012 refers to Windows Server 2012 Essentials Edition, Server 2012 standard Edition.
- ❑ Windows Server 2008 refers to Windows Server 2008 Standard Edition and Windows Server 2008 Enterprise Edition.
- ❑ Windows Server 2008 x64 refers to Windows Server 2008 x64 Standard Edition, Windows Server 2008 x64 Enterprise Edition, Windows Server 2008 R2 Standard Edition, and Windows Server 2008 R2 Enterprise Edition.
- ❑ Windows Server 2003 refers to Windows Server 2003 Standard Edition and Windows Server 2003 Enterprise Edition.
- ❑ Windows Server 2003 x64 refers to Windows Server 2003 x64 Standard Edition and Windows Server 2003 x64 Enterprise Edition.

### Mac OS X

In this manual, "Mac OS X" is used to refer to "OS X Yosemite", "OS X Mavericks", "OS X Mountain Lion", "OS X Lion", and "Mac OS X v10.6.8".





## Introduction

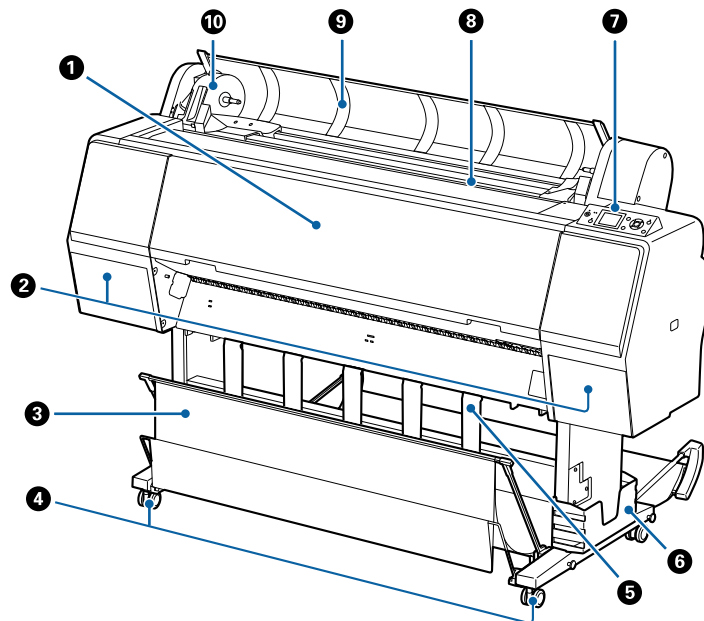

# Printer Parts

## Front



- 1 Front cover**  
Open this cover when cleaning the printer or clearing jams.
- 2 Ink covers (on the left and right)**  
Open when installing ink cartridges. Press the  button on the control panel to open by 5 mm.

 [“Replacing Ink Cartridges” on page 133](#)
- 3 Paper basket**  
Output from the printer collects in this basket, keeping the media clean and free of creases.

 [“Using the Paper Basket” on page 39](#)
- 4 Casters**  
There are two casters on each leg. The casters are normally kept locked once the printer is in place.
- 5 Paper support**  
Use this to control the paper eject direction for the roll paper.
- 6 Manual box**  
Holds the manual for the printer. This can be installed on the left or on the right.
- 7 Control panel**  
 [“Control panel” on page 12](#)

## Introduction

### 8 Paper feed slot

Insert the paper into this slot.

 [“Loading and Removing the Roll Paper” on page 28](#)

 [“Loading and Removing Cut Sheets” on page 34](#)

### 9 Roll paper cover

Open to load roll paper.

### 10 Adapter holder

The roll paper adapter is placed in this holder when loading the roll paper.

---

## Back

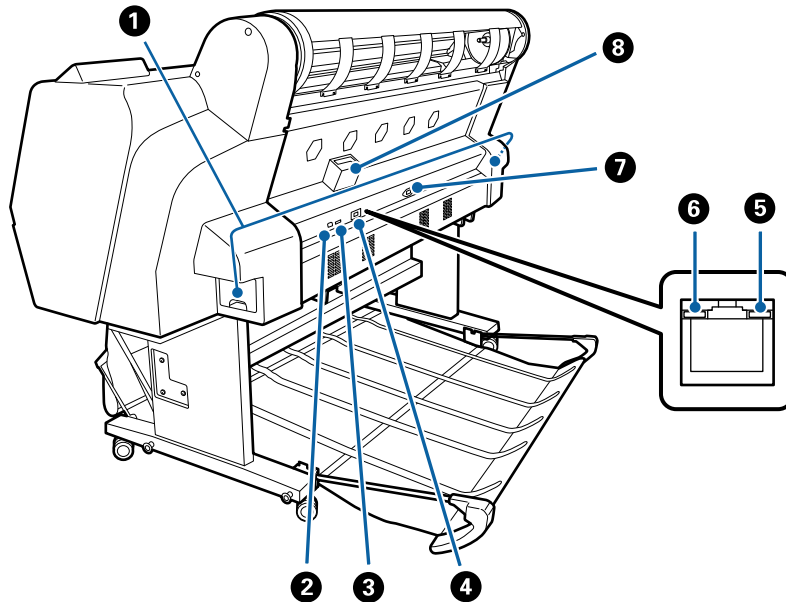

### 1 Maintenance Box

Absorbs waste ink. The SC-P9000 Series/SC-P8000 Series has one on the left and one on the right, and the SC-P7000 Series/SC-P6000 Series has one on the right.

 [“Replacing Maintenance Boxes” on page 134](#)

### 2 USB port

Connects the USB cable.

### 3 Option port

Connects the optional SpectroProofer mounter or Auto Take-up Reel Unit (for the SC-P9000 Series/SC-P8000 Series only).

### 4 LAN port

Connects the LAN cable.

## Introduction

### 5 Data light

The network connection status and data reception are indicated by a lit or flashing light.

On : Connected.

Flashing : Receiving data.

### 6 Status light

The color indicates the network transmission speed.

Off : 10Base-T

Red : 100Base-TX

Green : 1000Base-T

### 7 AC inlet

Connect the supplied power cable here.

### 8 Option slot

Connects the optional hard disk unit.

Introduction

## Roll paper adapter

Use the supplied roll paper adapter when loading roll paper onto the printer.

📖 “Loading and Removing the Roll Paper” on page 28

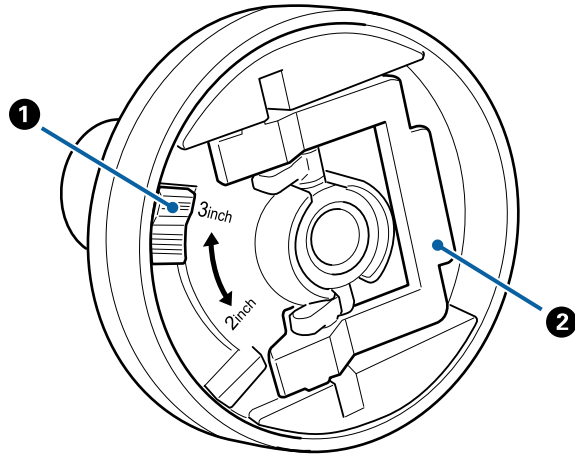

**1 Size lever**

Position according to the size of the roll core.

**2 Adapter lock lever**

Lift to unlock, lower to lock. Unlock when attaching roll paper to the adapter, lock once the roll is attached.

## Control panel

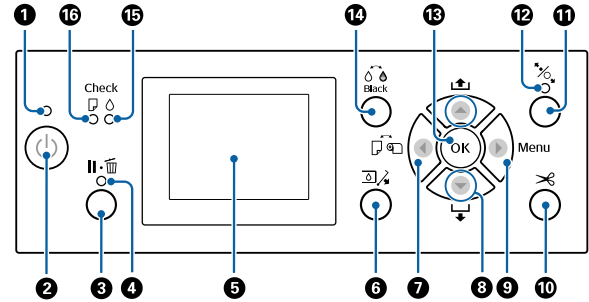

**1 Power light**

The printer’s operational status is indicated by a lit or flashing light

On : The power is on.

Flashing : The printer is receiving data or cleaning the print head or performing other operations in the course of being shut down.

Off : The power is off.

**2 Power button** ⏻

Turns the printer on or off.

**3 Pause/Cancel button** ⏸

☐ The printer enters pause status if this is pressed while printing. To release the pause status, press the ⏸ button again, or select **Pause Cancel** on the screen and then press the OK button. To cancel print jobs being processed, select **Job Cancel** on the screen and then press the OK button.

☐ Pressing this button while a menu is displayed closes the menu and returns the printer to ready status.

**4 Pause light**

Indicates whether or not the printer is ready.

On : Cannot print. (The printer is paused, a job is being canceled, a menu is displayed, an error has occurred, and so on.)

Off : Ready to print.

**5 Screen**

## Introduction

Displays the printer's status, menus, error messages, and so on.

 [“Screen View” on page 14](#)

 [“What to do When a Message is Displayed” on page 139](#)

### 6 Open ink cover button









Press to open the ink cover when replacing the ink cartridges and so on. When you select the ink cover you want to open, the ink cover opens approximately 5 mm when you press the OK button.

Button operations are disabled while printing or cleaning.

### 7 Paper source button

- If this is pressed before loading paper, the Paper Source screen is displayed, and you can select roll paper or cut sheets.
- If this is pressed while a menu is displayed, you are returned to the previous menu.

### 8 Paper feed button

- When roll paper is loaded, press the  button to feed the roll paper. Press the  button to rewind. Keep the  button pressed to feed the paper up to 3 m. Keep the  button pressed to rewind the paper up to 20 cm.
- If this is pressed while pressure roller is released, you can adjust the strength of the paper suction for the loading path in three stages.
- If you press  when the thickness of the loaded cut sheets is less than 0.5 mm, the paper is fed and the printer is ready to print.  
 [“Loading and Removing Cut Sheets” on page 34](#)
- Press  to eject paper when cut sheets are loaded.  
 [“Removing Cut Sheets” on page 36](#)
- Press to select menu items and parameter when a menu is displayed.

### 9 Menu button

- If this is pressed when the printer's menu can be changed (the printer is ready to print or there is no paper), the Settings menu is displayed.  
 [“Using the Control Panel Menu” on page 108](#)
- If this is pressed while a menu is displayed, you are taken to the next menu.

### 10 Paper cut button

It is used to manually cut roll paper using the built-in cutter.

 [“Manual cut method” on page 32](#)

### 11 Load paper button

- Locks or releases the pressure roller. When you want to load paper, press once to release the lock, and then adjust the paper to the loading position. Press again to feed the paper and the printer is ready to print.
- If this is pressed when **Remaining Setup** is set to **On** in the Paper menu, a barcode is printed on the edge of the roll paper, and the pressure roller is released.

### 12 Load paper light

The status of the pressure roller is indicated by whether the light is on or off.

On : The pressure roller is released. When the light is on, printing cannot be performed.

Off : The pressure roller is locked.

### 13 OK button

- If this is pressed while a parameter is selected from the Menu, the parameter is set or executed.
- If this is pressed when no paper is loaded, the Paper Loading Method menu is displayed. When the paper type is selected, you can check the loading method.
- If this is pressed while drying ink or a color chart, drying is canceled.

### 14 Change black ink button

- Changes the type of black ink.  
 [“Changing the Type of Black Ink” on page 54](#)
- If this is pressed when the paper setting name or the password entry screen is displayed, you can change the type of letters.

### 15 Ink check light

**Introduction**

The ink status is indicated by a lit or flashing light.

**On** : Indicates errors such as an installed ink cartridge is expended, an ink cartridge is not installed, or a wrong ink cartridge is installed. Check the contents of the error on the control panel's screen.

**Flashing** : The ink is low. We recommend replacing the ink cartridge as soon as possible because the ink may be expended while printing.

**Off** : No error.

**16 Paper check light**

The paper status is indicated by a lit or flashing light.

**On** : Indicates an error such as there is no paper or that the paper differs to the paper setting. Check the contents of the error on the control panel's screen.

**Flashing** : Indicates an error such as a paper jam or that the paper has skewed. Check the contents of the error on the control panel's screen.

**Off** : No error.

**Screen View**



**1. Messages**

Displays the printer's status, operations, and error messages.

[“What to do When a Message is Displayed” on page 139](#)

[“Using the Control Panel Menu” on page 108](#)

**2. Paper Source**

The settings for Paper Source (roll paper or cut sheets) and Auto Cut for roll paper are indicated by the icons in the following table.

The paper name selected in **Paper Type** is displayed on the right of the icon. When **Custom Paper** is selected, a number is displayed on the paper icon.

[“Paper” on page 116](#)

Icon	Explanation
	Prints on roll paper. The paper is cut automatically after printing one page.
	Prints on roll paper. Auto cut is not performed.
	Prints on cut sheets.

**3. Platen Gap**

Displays the **Platen Gap** settings.

[“Custom Paper Setting” on page 117](#)

[“Printer Setup” on page 120](#)

Icon	Explanation
	<b>Standard</b> is selected
	<b>Narrow</b> is selected
	<b>Wide</b> is selected
	<b>Wider</b> is selected

## Introduction

Icon	Explanation
	<b>Widest</b> is selected

### 4. Roll Paper Margin

Displays the value set for **Roll Paper Margin**.

- Auto: **Standard** is set
- 15mm: **Top15mm/Bottom15mm** is set
- 35/15mm: **Top35mm/Bottom15mm** is set
- 150/15mm: **Top150mm/Bottom15mm** is set
- 3mm: **3mm** is set
- 15mm: **15mm** is set

 ["Paper" on page 116](#)

### 5. Approximate amount of ink remaining for each color

Displays the amount of ink remaining for each color.

#### Ink codes





SC-P9000 Series/SC-P7000 Series	
C	Cyan
OR	Orange
Y	Yellow
LC	Light Cyan
MK	Matte Black
PK	Photo Black
VM	Vivid Magenta
LK	Light Black
GR	Green
LLK/V*	Light Light Black/Violet
VLM	Vivid Light Magenta

\* The display differs depending on the inksets being used.

SC-P8000 Series/SC-P6000 Series	
C	Cyan
Y	Yellow

SC-P8000 Series/SC-P6000 Series	
LC	Light Cyan
MK	Matte Black
PK	Photo Black
VM	Vivid Magenta
LK	Light Black
LLK	Light Light Black
VLM	Vivid Light Magenta

### Ink remaining (using Cyan as an example)

Icon	Ink Remaining in Cartridge
	No error. The height of the indicator changes with the level of ink remaining.
	Ink is low. You need to prepare a new ink cartridge.
	Ink cartridge is expended; replace with a new ink cartridge.
	An error occurred. Check the message on the screen, and clear the error.



### 6. Usage status of optional item

Displays the availability of optional item.

Nothing is displayed when the item is not connected.

#### Auto take-up reel unit\*

\* Only SC-P9000 Series/SC-P8000 Series are supported

Icon	Status
	Available
	Not Available



#### SpectroProofer Mounter 24"/44"

Icon	Status
	Available

## Introduction

Icon	Status
	Not Available

### Hard disk unit

Icon	Status
	Available
	Communicating
	Not Available



### 7. Usage status of black ink

Displays the selected black ink.

### 8. Approximate space in Maintenance Box

Displays the approximate amount of space in the Maintenance Box.

For the SC-P9000 Series/SC-P8000 Series there are two icons, and for the SC-P7000 Series/SC-P6000 Series there is one icon.

Icon	Space in Maintenance Box
	No error. The height of the indicator corresponds to the amount of space.
	The Maintenance Box is nearing the end of its service life. You need to prepare a new Maintenance Box.
	Maintenance Box is at the end of its service life. Replace the Maintenance Box with a new one.

### 9. Roll paper remaining

When **Remaining Setup** is set to **On** in the Paper menu, the amount of roll paper remaining is displayed. When the length remaining falls below the value set in **Set Alert Length**, a  appears above the icon to warn you that the printer is nearing the end of the roll.

 [“Paper” on page 116](#)

## Features

The main features of this printer are described below.

### Realizing High Resolution

The newly developed ink technology provides high definition for photo, fine art, and proofing paper.

### Pigmented inks with superior resistance

Pigment inks maintain more beautiful and more vibrant prints over a long period of time with their high light fastness. They are also extremely fade-resistant and can be safely displayed in direct sunlight. Additionally, the high water and ozone resistance is not only ideal for photo printing, but also allows for store displays and banners, outdoor displays of posters and so on. When you are printing for outdoor use, use lamination processing.

### Two types of black ink with maximum black density (Dmax)

By automatically switching to suit the paper type being used, the two types of black ink provided are Photo Black which realizes a smooth, professional finish on glossy paper, and Matte Black which increases black optical density using matte paper. The maximum density (Dmax) improves on previous black inks and brings out delicate tone differences in gradations.

 [“Changing the Type of Black Ink” on page 54](#)

### Multi-colored ink variation

#### **Chooses between two sets of 10 color inks to suit your use (SC-P9000 Series/SC-P7000 Series)**

The following shows the two types of ink sets available for Epson UltraChrome HDX (SC-P9000 Series/SC-P7000 Series). The ink set cannot be changed once it has begun to be used.

- Light Light Black inkset ideal for gradations  
Three types of black ink density, Photo Black, Light Black and Light Light Black, allows you to bring out



## Introduction

delicate tone differences in black-and-white images.

In addition, the other seven colors, including Orange and Green, realize superior color reproduction creating bright and vivid images in green to yellow and yellow to red.

- Violet inkset providing a wide range of color reproduction  
As well as Orange and Green, this set comes with eight color inks including the newly developed Violet. By realizing superior color reproduction creating bright and vivid images in green to yellow and yellow to red, as well as deep shades of blue, we have achieved the industry's best PANTONE cover ratio.

### **Basic eight color inks including three types of black (SC-P8000 Series/SC-P6000 Series)**

The Epson UltraChrome HD (SC-P8000 Series/SC-P6000 Series) ink realizes delicate tone differences in black-and-white images using three types of black ink density, Photo Black, Light Black, and Light Light Black, in addition to five basic color inks for photo and proofing.

---

## Superior Ease of Use

### **Spindle-free roll paper adapter makes loading roll paper a snap**

The lack of a spindle makes it possible to load and remove roll paper even in environments where space is at a premium. To load roll paper, simply place it on the top of the printer and attach roll paper adapters to both ends.

 [“Loading Roll Paper” on page 28](#)

### **Improved color adjustment function (Epson Color Calibration Utility)**

The Epson Color Calibration Utility software provided on the software disc supplied allows you to easily perform color calibration using the printer's built-in sensors.

### **Adjust all prints with one calibration**

By saving the calibration data to the printer, you do not need to perform calibration for every paper type or mode. Also, you do not need to make individual calibrations when sharing the printer with multiple users.

### **Perform color management for multiple printers**

You can perform color management for multiple printers that are the same model and use the same inkset.

See the Epson Color Calibration Utility manual for details.

### **Improved energy efficiency with sleep mode and Power Off Timer**

When no print jobs are being handled, or when no operation has been performed for some time, the printer enters sleep mode to reduce power consumption. Furthermore, if the Power Off Timer function is enabled, the printer can automatically switch off to avoid wasting electricity. This function works if no print jobs are received and no operations are carried out on the control panel while the printer is not in an error status for a specified duration of time.

 [“Turning Off the Power Using Power Off Timer” on page 56](#)

---

## Various Options

### **Optimized printing (Hard disk unit)**

When the hard disk unit is installed, print jobs can be saved, queued, and reprinted. Saved print jobs can also be printed from the printer's control panel. This reduces the time from starting your computer and printing from an application, as well as allowing you to reprint quickly.

 [“Using the Optional Hard Disk Unit” on page 57](#)

## Introduction

### Automatic color management (SpectroProofer mouter)

With the SpectroProofer Mouter 24"/44" installed, you can perform printing, drying, and color measurement operations in sequence on roll paper. Another optional color measurement device ILS30EP can be used for a variety of color measurement conditions including the new M1 standard. (Supports M0/M1/M2)

Also, the 44" model is up to two times faster than conventional models, provides more accurate readings with the addition of a function to prevent misaligned measurement position, and realizes savings by reducing the amount of paper used to print charts by half of the conventional model ratio.

To use this you need commercially available RIP software.

### Efficient continuous printing on roll paper (Auto take-up reel unit)

When using the optional auto take-up reel unit with the SC-P9000 Series/SC-P8000 Series, roll paper can be automatically wound up after printing for efficient continuous printing.

 [“Using the Auto Take-up Reel Unit \(SC-P9000 Series/SC-P8000 Series Only\)” on page 43](#)

## Notes on Usage and Storage

### Installation space

Make sure that you secure a space of at least 300 mm around the entire printer, clear of any other objects, so that paper ejection and consumable replacement are not obstructed.

See the “Specifications Table” for the external dimensions of the printer.

 [“Specifications Table” on page 183](#)

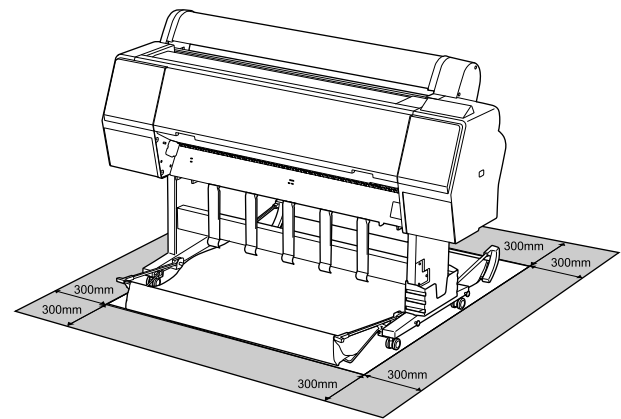

### Notes when using the printer

Note the following points when using this printer to avoid breakdowns, malfunctions, and print quality decline.

- ❑ When using the printer, observe the operating temperature and humidity range described in the "Specifications Table".  
 [“Specifications Table” on page 183](#)  
 Even when the conditions above are met, you may not be able to print properly if the environmental conditions are not suitable for the paper. Be sure to use the printer in an environment where the paper's requirements are met. For more details, see the documentation supplied with the paper.  
 Also, when operating in dry areas, air conditioned environment, or under direct sunlight, maintain the appropriate humidity.

## Introduction

- ❑ Do not install the printer next to heat sources or directly in the path of air from a ventilator or air conditioner. Failure to observe this precaution could result in the print head nozzles drying and clogging.
- ❑ The print head may not be capped (i.e., may not move to the right-hand side) if an error occurs and the printer is turned off without first resolving the error. Capping is a function for automatically covering the print head with a cap (lid) to prevent the print head from drying out. In this case, turn on the power and wait a while until capping is performed automatically.
- ❑ When the power is on, do not remove the power plug or cut the power at the breaker. The print head may not be capped properly. In this case, turn on the power and wait a while until capping is performed automatically.
- ❑ Even when the printer is not in use, some ink will be consumed by head cleaning and other maintenance operations needed to keep the print head in good condition.

### Notes when not using the printer

If you are not using it, note the following points when storing the printer. If it is not stored correctly, you may not be able to print properly the next time it is used.

- ❑ If you do not print for a long time, the print head nozzles may become clogged. We recommend that you print once a week to prevent the print head from clogging.
- ❑ The roller may leave an impression on paper that is left in the printer. This can also cause wavy or curled paper resulting in paper feeding problems or the print head could be scratched. Remove any paper when storing.
- ❑ Store the printer after confirming that the print head has been capped (the print head is positioned at the far right). If the print head is left uncapped for a long time, the print quality may decline.

**Note:**

*If the print head is not capped, turn the printer on, and then turn it off.*

- ❑ To prevent the accumulation of dust and other foreign matter in the printer, close all covers before placing it in storage.  
If the printer will be not be used for an extended period, protect it with an anti-static cloth or other cover.  
The print head nozzles are very small, and they can become clogged easily if fine dust gets on the print head, and you may not be able to print properly.
- ❑ When turned on after an extended period of disuse, the printer may automatically perform head cleaning to ensure print quality.  
 [“Timer Cleaning” on page 125](#)

### Notes on handling ink cartridges

Note the following points when handling ink cartridges to maintain good print quality.

- ❑ The supplied ink cartridges and Maintenance Box are for use during the initial charging. The supplied ink cartridges and Maintenance Box will be require replacement relatively quickly.
- ❑ We recommend that ink cartridges be stored at room temperature out of direct sunlight and used before the expiry date printed on the packaging.
- ❑ For optimum print quality, we recommend using up ink within six months after installing in the printer.
- ❑ Ink cartridges that have been stored at low temperatures for an extended period should be allowed to return to room temperature over a period of four hours.
- ❑ Do not touch the IC chips on the ink cartridges. You may not be able to print properly.
- ❑ Install all ink cartridges into each slot. You cannot print if any of the slots are empty.
- ❑ Do not leave the printer without ink cartridges installed. The ink in the printer may dry, preventing it from printing as expected. Leave ink cartridges in all slots even while you do not use the printer.
- ❑ The ink level and other data are stored in the IC chip, allowing cartridges to be used after being removed and replaced.

## Introduction

- ❑ To avoid getting dirt on the ink supply port, store the removed ink cartridge properly. The ink supply port has a valve in it so it does not need to be capped.
- ❑ Removed ink cartridges may have ink around the ink supply port, so be careful not to get any ink on the surrounding area when removing the cartridges.
- ❑ To maintain the quality of the print head, this printer stops printing before ink cartridges are completely expended.
- ❑ Although the ink cartridges may contain recycled materials, this does not affect printer function or performance.
- ❑ Do not dismantle or remodel ink cartridges. You may not be able to print properly.
- ❑ Do not drop or knock ink cartridges against hard objects; otherwise, the ink may leak.

---

### Notes on handling paper

Note the following points when handling and storing the paper. If the paper is not in good condition, print quality may decline.

Check the documentation supplied with each paper.

### Notes on Handling

- ❑ Use Epson special media under normal room conditions (temperature: 15 to 25°C, humidity: 40 to 60%).
- ❑ Do not fold the paper or scratch the surface of the paper.
- ❑ Avoid touching the printable surface of the paper with your bare hands. Moisture and oils from your hands can affect print quality.
- ❑ Handle paper by the edges. We recommend wearing cotton gloves.
- ❑ Changes in temperature and humidity may cause paper to become wavy or curled. Check the following points.
  - ❑ Insert the paper just before printing.
  - ❑ Do not use wavy or warped paper.

For roll paper, cut off any parts that are wavy or curled, and then load the paper again.  
For cut sheets, use new paper.

- ❑ Do not wet the paper.
- ❑ Do not throw away the paper packaging as you can use it for storing the paper.
- ❑ Avoid locations that are subject to direct sunlight, excessive heat, or humidity.
- ❑ Keep cut sheets in their original package after opening, and keep them in a flat place.
- ❑ Remove roll paper that is not in use from the printer. Rewind it correctly and then store it in the original packaging that came with the roll paper. If you leave the roll paper in the printer for a long time, its quality may decline.

### Notes on handling printed paper

To maintain long lasting, high quality print results, note the following points.

- ❑ Do not rub or scratch the printed surface. If they are rubbed or scratched, the ink may peel off.
- ❑ Do not touch the printed surface; Failure to observe this precaution may cause ink to rub off.
- ❑ Make sure the print outs are completely dry before folding or stacking; otherwise, the color may change where they touch (leaves a mark). These marks will disappear if they are separated immediately and dried; however, they will remain if not separated.
- ❑ If you put the print outs in an album before they are completely dry, they may be blurred.
- ❑ Do not use a dryer to dry the print outs.
- ❑ Avoid direct sunlight.
- ❑ Prevent color distortion while displaying or storing the print outs by following the instructions in the paper's documentation.

## Introduction

**Note:**

*Typically, print outs and photos fade over time (color distortion) due to the effects of light and various constituents in the air. This also applies to Epson special media. However, with the correct storage method, the degree of color distortion can be minimized.*

- ❑ *See the documentation supplied with Epson special media for detailed information on handling the paper after printing.*
- ❑ *The colors of photos, posters, and other printed materials appear different under different lighting conditions (light sources<sup>\*</sup>). The colors of print outs from this printer may also appear different under different light sources.*  
*\* Light sources include sunlight, fluorescent light, incandescent light, and other types.*

## Introduction

# Introducing the Software

As well as the printer driver, a variety of software packages are also provided such as Network easy configuration and plug-in software to add functionality to commercially available packages. You can install the software from the software disc supplied, or by downloading from the Epson website.

 [“Software on the Disc” on page 22](#)

 [“Software on the Website” on page 25](#)

There is also software that can be used over a network through a web browser without having to install it.

 [“Remote Manager” on page 26](#)

---





## Software on the Disc

The supplied Software Disc contains the following software. For details on using the software, see the PDF manuals or the on-line help for the software in question.

**Note:**

*You can upgrade the software supplied. Check for the latest versions on the Epson website.*

<http://www.epson.com>

Software Name	Explanation
Printer Driver	The printer driver is required when using the printer. Follow the steps in the "Setup Guide" to install.  <a href="#">“Summary of the Printer Driver” on page 23</a>
Epson Network Utilities	When a network connection is setup using the "Setup Guide", network related modules are installed. See the "Network Guide" (PDF).
EpsonNet Config	With this software, you can configure various network settings for the printer from your computer. This is useful as it allows you to enter addresses and names using the keyboard. Installation  <a href="#">“Installing individually” on page 24</a>
EPSON LFP Remote Panel 2	Software for registering custom paper from a computer. Installation  <a href="#">“Installing individually” on page 24</a>
Epson Color Calibration Utility	Software that performs calibrations using the printer's built-in sensors. Installation  <a href="#">“Installing individually” on page 24</a>

## Introduction

### Summary of the Printer Driver

The main functions of the printer driver are described below.

- ❑ Converts print data received from applications into printable data and sends it to the printer.
- ❑ Settings such as document size and print quality can be adjusted from the settings dialogs.

#### Windows

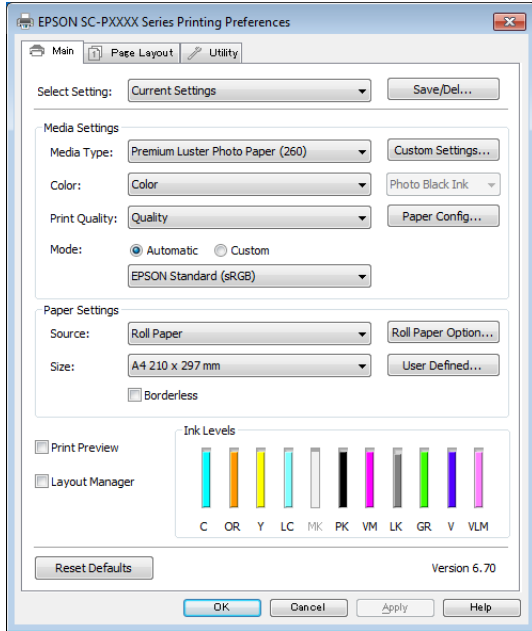

You can save these settings and easily import or export these saved settings.

[👉 “Customizing the Printer Driver” on page 63](#)

#### Mac OS X

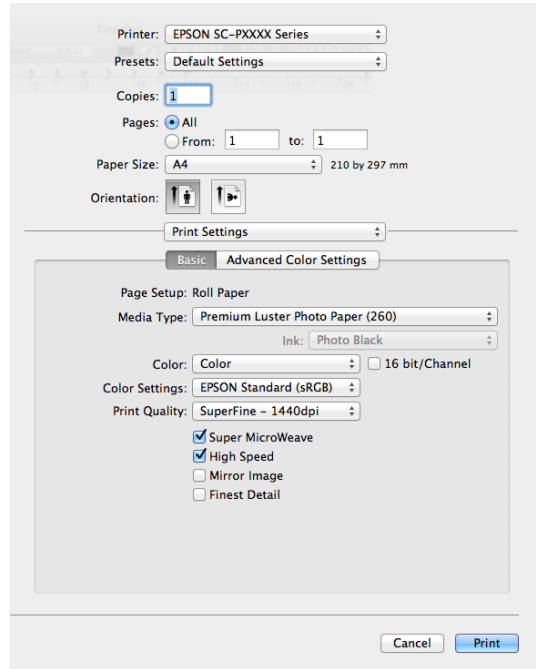

- ❑ Allows you to execute printer maintenance functions to maintain print quality, check the printer's status, and so on.

#### Windows

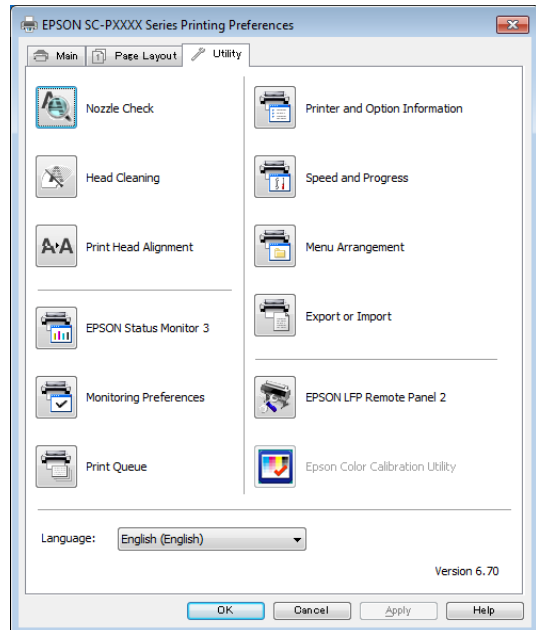

You can easily import or export printer driver settings.

[👉 “Summary of the Utility Tab” on page 66](#)

## Introduction

### Mac OS X



### Installing individually

Insert the software disc into the disk drive, and then follow the on-screen instructions.

The screens displayed differ according to the operating system being used as shown below.

### Windows

Click **Information for Manuals and Applications**.

Check the folder containing the necessary software, and install.

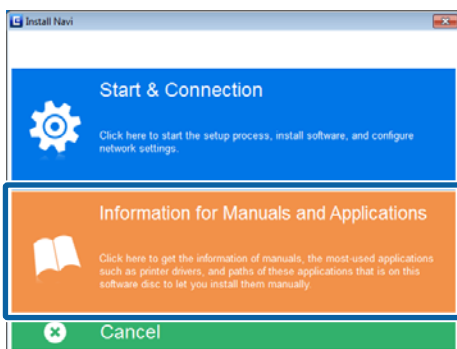

### Mac OS X

Select the necessary software, and then click **Install**.

Clear the checkboxes for any software that has already been installed.

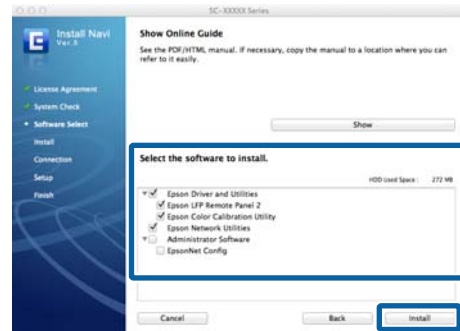

Follow the on-screen instructions to install.

See the following for instructions on starting and closing the software.

[👉 “Starting and Closing Software” on page 26](#)



## Introduction

### Software on the Website

Aside from the software supplied on the software disc, the latest software versions for this printer can also be found on the Epson website. Download as required.

<http://www.epson.com>

**Note:**

*Depending on your country or region, you may not be able to download software from the website.*

*For more details, contact your dealer or Epson Support.*

For details on using the software, see the PDF manuals or the on-line help for the software in question.

See the following for instructions on starting and closing the software.

 [“Starting and Closing Software” on page 26](#)

Software Name	Explanation
LFP Print Plug-In for Office*	<p>Plug-in software for Microsoft Office applications (Word, Excel, and PowerPoint). Installing this plug-in displays a ribbon in Office applications that gives quick access to horizontal and vertical banner printing and enlarged printing.</p> <p>Before installing the plug-in, check the following.</p> <ul style="list-style-type: none"> <li><input type="checkbox"/> Office applications are installed.</li> <li><input type="checkbox"/> Office applications are not running.</li> </ul>
LFP HDD Utility*	The Utility can be used to manage print jobs stored on the optional hard disk unit. Use this when connecting the printer directly to the computer using a USB cable.
Epson Print Layout	<p>This is a plug-in for Adobe Photoshop and Adobe Lightroom.</p> <ul style="list-style-type: none"> <li><input type="checkbox"/> By operating with Adobe Photoshop and Adobe Lightroom, you can easily perform color management.</li> <li><input type="checkbox"/> You can check the adjusted image for black-and-white photographs on the screen.</li> <li><input type="checkbox"/> You can save your preferred paper type and size and load them easily.</li> <li><input type="checkbox"/> You can easily layout and print photos.</li> </ul>
LFP Accounting Tool*	This software provides total cost calculations for printed paper, job information, and so on.
CopyFactory*	This software allows you to make enlarged copies using an Epson scanner. Check for supported scanners on the Epson website.

\* Windows only

## Introduction

### Remote Manager

This software allows you to operate the printer from a computer over a network using the printer's built-in network interface. You can check the printer's status and configure network settings, in addition to managing the print jobs stored on the optional hard disk unit. You can perform the following operations for print jobs stored on the hard disk unit.

- Cancel individual print queue
- Cancel individual hold queue
- Resume hold queue

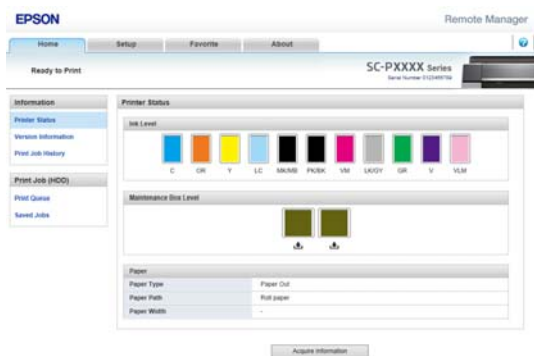

#### Starting

Enter the printer's IP address in a computer web browser.



For more information, see the online help for Remote Manager.

## Starting and Closing Software

### Starting

You can start by using any of the following methods.

#### Double-click the shortcut icon on the desktop

Depending on the software being used, a shortcut icon may not be created during installation.

### Starting from the menu

- Windows 8.1/Windows 8  
Enter the software name in the search charm, and then select the icon displayed.
- Other than Windows 8.1/Windows 8  
Click the Start button, click the installed software name from **All Programs** (or **Programs**) or in the **EPSON** folder, and then select the software you want to start.
- Mac OS X  
Click the installed software name from **Applications** or the EPSON folder, and then select the software you want to start.

#### Click the icon on the desktop taskbar (Windows only)

Click the icon and select the software you want to start from the menu displayed.

### Closing

The application can be closed using one of the following methods.

- Click the button (**Exit**, **Close**, , and so on).
- Select **Exit** from the toolbar menu.

Introduction

# Uninstalling Software

## Windows

**Important:**

- ❑ You must log in with an Administrators group.
- ❑ In Windows 7/Windows Vista, if an Administrator password or confirmation is requested, enter the password and then continue with the operation.

- 1 Turn off the printer, and unplug the interface cable.
- 2 Go to the **Control Panel** and click **Uninstall a program** from the **Programs** category.



- 3 Select the software you want to remove and then click **Uninstall/Change** (or **Change/Remove/Add or remove**).

You can remove EPSON Status Monitor 3 and the printer driver by selecting **EPSON SC-XXXXX Printer Uninstall**.

Select **EPSON LFP Remote Panel 2** to remove EPSON LFP Remote Panel 2.

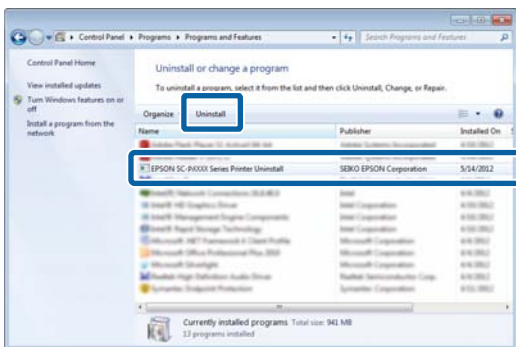

- 4 Select the target printer icon, and then click **OK**.

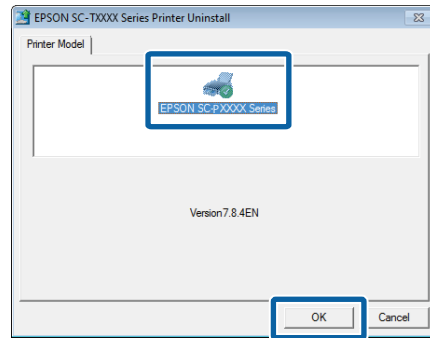

- 5 Follow the on-screen instructions to continue. When the delete confirmation message appears, click **Yes**.

Restart the computer if you are reinstalling the printer driver.

## Mac OS X

When reinstalling or upgrading the printer driver or other software, follow the steps below to uninstall the target software first.

**Printer Driver**  
Use the "Uninstaller".

**Downloading the Uninstaller**  
Download the Uninstaller from the Epson website.

<http://www.epson.com/>

**Using the Uninstaller**  
Follow the instructions on the Epson website.

**Other software**  
Drag and drop folder with the software name from the **Applications** folder into **Trash** to delete.

Basic Operations

# Basic Operations

## Loading and Removing the Roll Paper

### Loading Roll Paper

Load roll paper after attaching the supplied roll paper adapters.

**Important:**

Insert the paper just before printing. The roller may leave an impression on paper that is left in the printer.

**Note:**

- ❑ The paper that can be used in the printer is detailed in the following section.  
📖 ["Supported Media" on page 159](#)
- ❑ When paper has not been loaded in the printer, press the OK button to check the loading methods.

Buttons that are used in the following settings

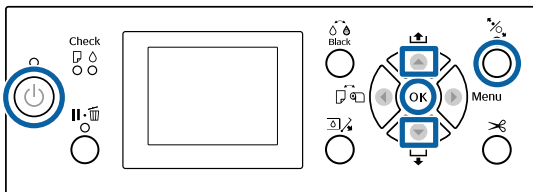

**1** Turn on the printer by pressing the button.

**2** Press the button, and then select **Roll Paper** from the Paper Source menu.

To automatically cut after printing, select **Roll Paper / Cut**. If you do not want to cut, select **Roll Paper / No Cut**.

**3** Open the roll paper cover.

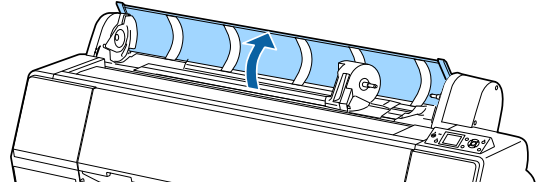

**4** Lower the lock lever for the adapter holder to release the lock.

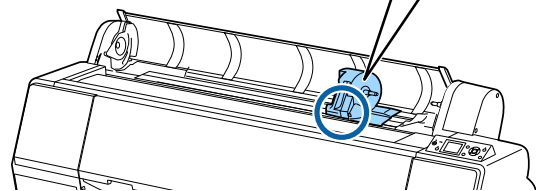
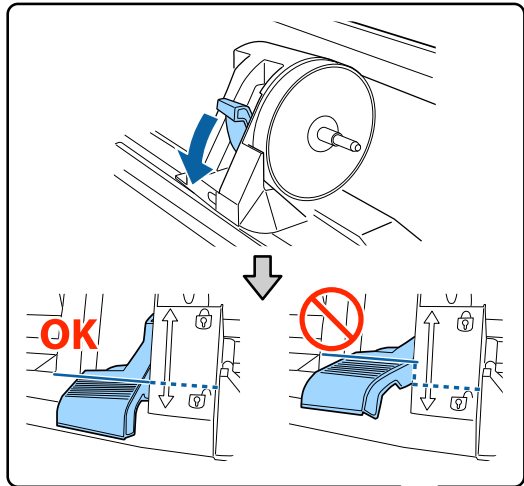

**5** Move the adapter holder to the left.

When moving the adapter holder, make sure you use the handle.

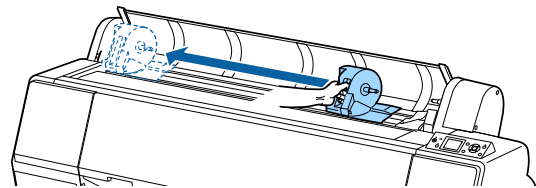

**6** Place the roll paper on top of the printer.

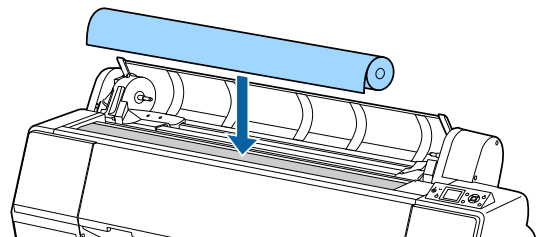

**Basic Operations**

- 7** Adjust the size of the roll paper adapters to the size of the roll core.  
Change the size of both of the roll paper adapters so that they are the same size.

**3-inch core**

**2-inch core**

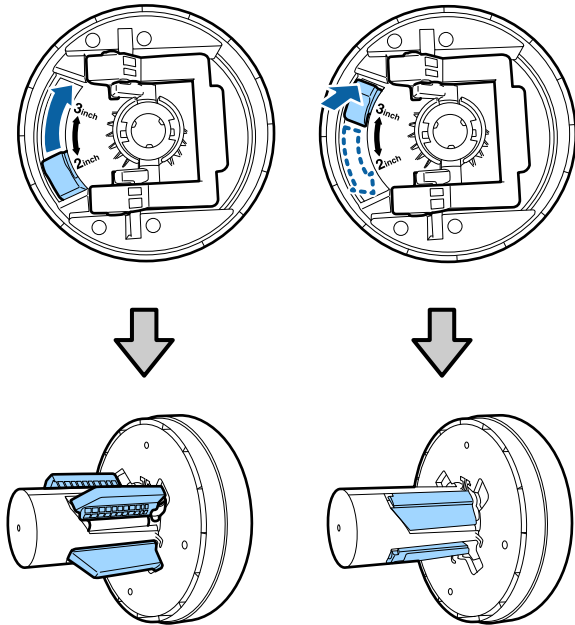

- 8** Raise the adapter lock lever to release the lock on each of the two roll paper adapters.

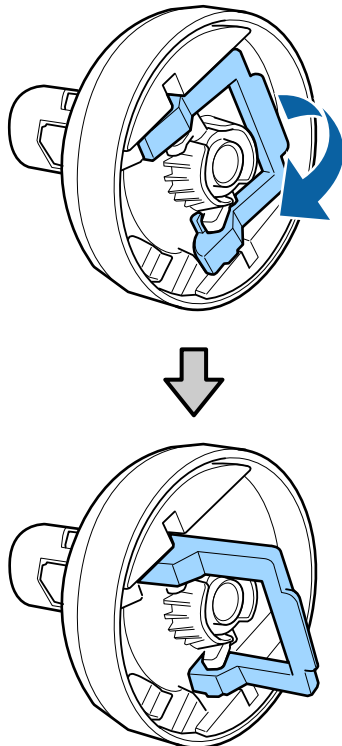

- 9** Attach the roll paper adapters to both ends of the roll paper, and then lower the lock levers on the left and right to lock them in place.  
Make sure you insert the adapters fully before locking them.

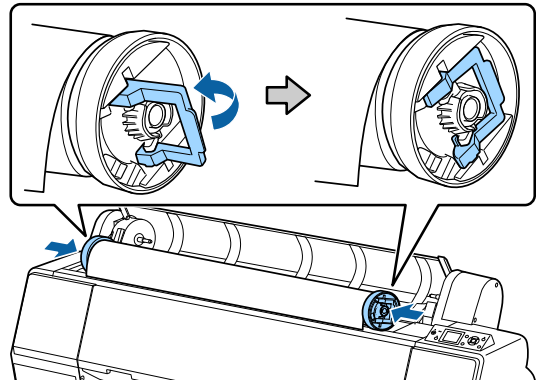

- 10** Push the roll paper to the right until it touches the roll paper loading guide.

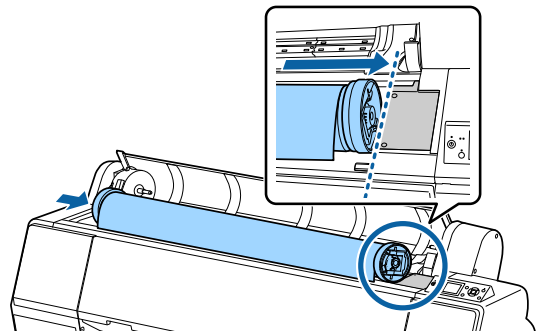

- 11** Move the adapter holder so that the ▲ on the adapter holder and the left roll paper adapter are aligned.

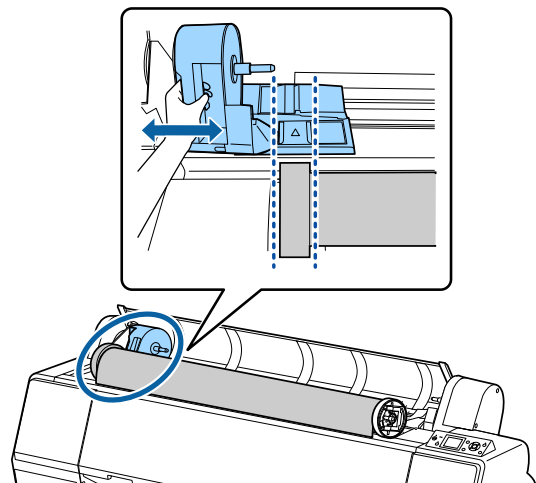

**Basic Operations**

- 12** Roll the roll paper slowly into the roll paper holder.

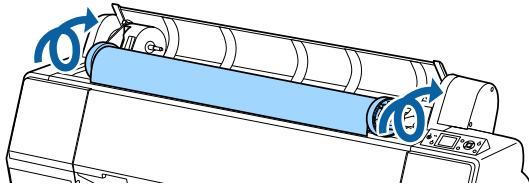

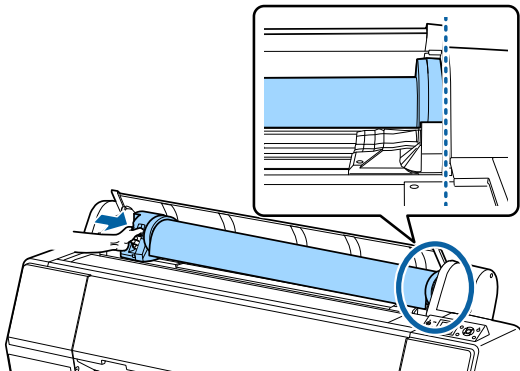

- 13** Grip the handle on the adapter holder and slide to the right until it is fully inserted to the holder shaft.

Make sure that both ends of the roll paper are seated securely to the adapters.



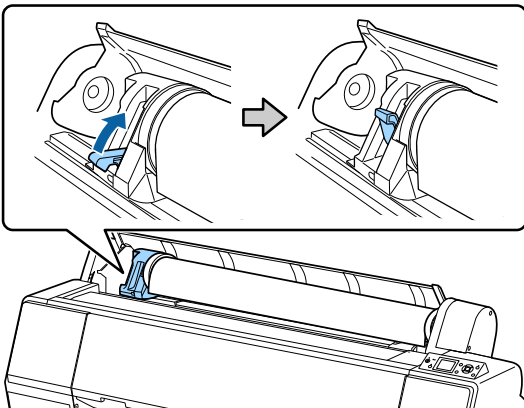

- 14** Raise the lock levers on the adapter holders to lock them in place.



- 15** Press the  button on the control panel. The pressure roller is released.

- 16** Insert the leading edge of the roll paper into the paper feed slot, and then feed the roll paper by hand until the leading edge comes out from below the front cover.

If the leading edge of the roll paper does not appear, use the  or  button to adjust the Paper Suction.

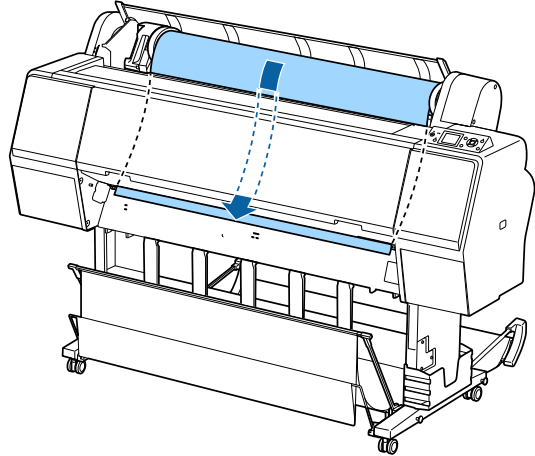

- 17** With both hands, pull the roll paper until the leading edge of the paper is in the center of the stand (the position of the label shown in the illustration).

Make sure that the roll paper is free of slack and the end is not folded.

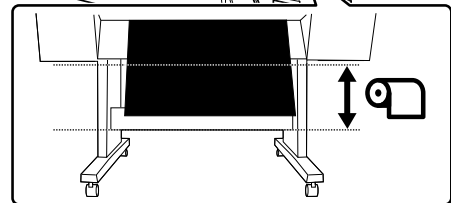
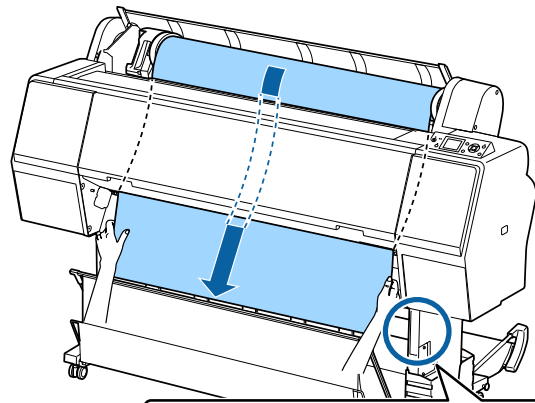

- 18** Close the roll paper cover.

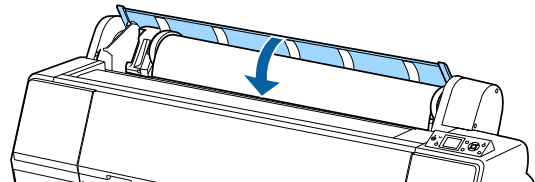

## Basic Operations



19

Press the  button.

After a few seconds, the paper moves to the starting print position.

When you press the  button, operations start immediately.

**Note:**

Pressing the  button within three seconds of pressing the  button cuts off the leading edge of the roll paper. This is useful if the leading edge is not already cut straight across or is not clean.

20

Check the media type.

 [“Checking and Setting the Paper Type” on page 37](#)

## Cutting the roll paper

The printer is equipped with a built-in cutter. You can cut roll paper after printing by using one of the following methods.

- Auto Cut:**  
The cutter cuts automatically at a determined position each time a page is printed in accordance with the setting of the printer driver or control panel menu.
- Manual cut:**  
The cutting position is specified on the control panel, and then the roll paper is cut. A cutline is printed for manual cutting and can be used as a guide when cutting paper using the built-in cutter.



**Important:**

*The commercially available media types, such as those shown below, may not be cut cleanly by the built-in cutter. Furthermore, cutting the following media types may damage or reduce the lifetime of the built-in cutter.*

- Fine art paper
- Canvas
- Vinyl
- Matte poster board
- Adhesive paper
- Banner media

*Cut these media types with commercially available scissors or a cutter in the following manner:*

*With the front cover closed, hold down the  button on the control panel while viewing the inside of the printer until the cutting position emerges from below the front cover. Cut the paper using scissors or a third-party cutter.*

## Setting Auto Cut

You can specify the method either on the control panel or the printer driver. Note, however, that the setting selected with the printer driver takes priority when the printer driver is used.

**Note:**

- Disable the auto cut settings in the printer and the printer driver when using the optional auto take-up reel unit.*
- It may take a while to cut the roll paper.*

### Setting on the computer

Set **Auto Cut** from the **Roll Paper Option** in the printer driver's **Properties** (or **Printing preferences**) screen.

### Setting from the printer

Press the  button and select auto cut on the Paper Source screen.

 [“Control panel” on page 12](#)

## Basic Operations

**Note:**

You can also select this from Paper - Roll Paper Setup - Auto Cut.

"Paper menu" on page 110

### Manual cut method

When **Off** is selected in the printer driver or **Off** is selected for **Auto Cut** in the control panel, the paper can be cut in any location after printing as described below.

Buttons that are used in the following settings

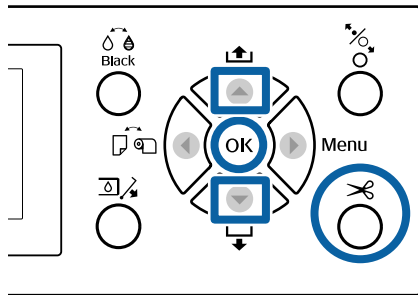

- 1 With the front cover closed, hold down the ▼ button on the control panel while viewing the inside of the printer until the cutting position reaches the position of the label.

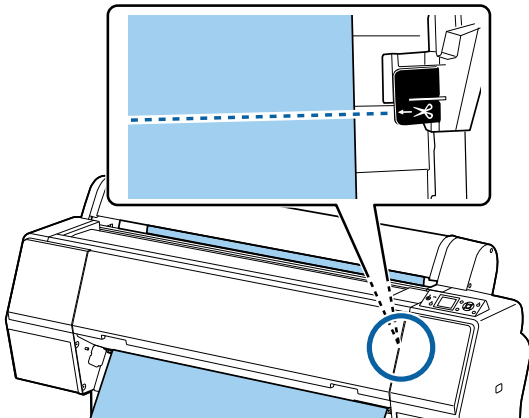

**Note:**

To cut the paper using the built-in cutter, the distance from the cutting position to the edge of the paper needs to be 60 to 127 mm. The necessary length differs depending on the paper type and cannot be changed. If the necessary length has not been reached, paper is fed automatically leaving a margin. Use a commercially available cutter to remove the unnecessary margin.

- 2 Press the ✂ button.  
A confirmation screen is displayed. Press the OK button to cut using the built-in cutter.  
Press the ◀ button to return to the previous menu.

### Removing Roll Paper

This section describes how to remove and store roll paper after printing. The pressure roller may leave impressions on paper that is left in the printer.

Buttons that are used in the following settings

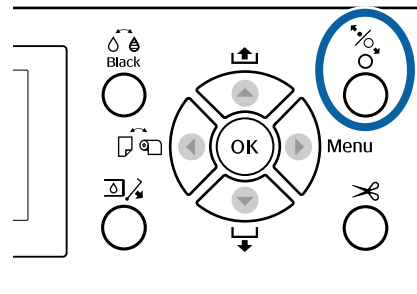

- 1 Make sure the printer is on.
- 2 Open the roll paper cover.

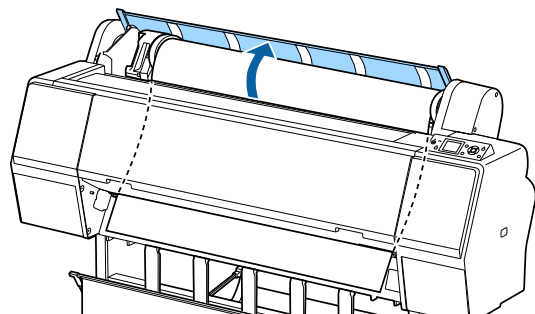



**Basic Operations**

- 3** Press the  button on the control panel to release the pressure roller.

The roll paper is automatically rewound if the printer state is after the paper cut but in the READY state. When **Remaining Setup** is set to **On**, the paper is rewound after printing the paper information. The paper is not rewound when using the optional auto take-up reel unit. If the paper is not rewound automatically, you need to rewind manually.

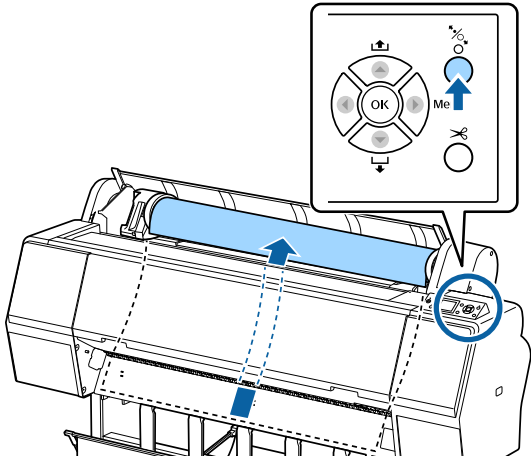

**Note:**

When removing the roll paper, you can use the optional roll paper belt to prevent the roll paper from unwinding.

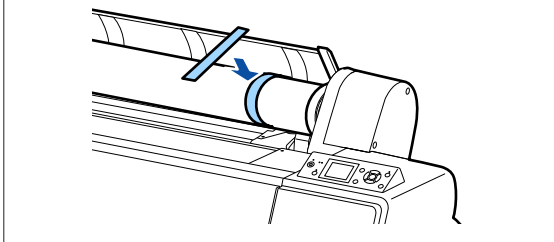

- 4** Lower the lock lever for the adapter holder to release the lock.

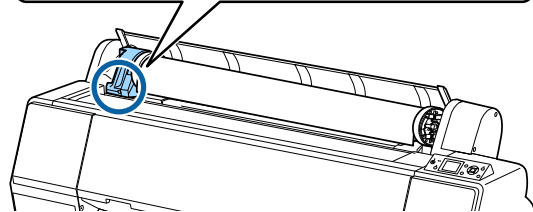
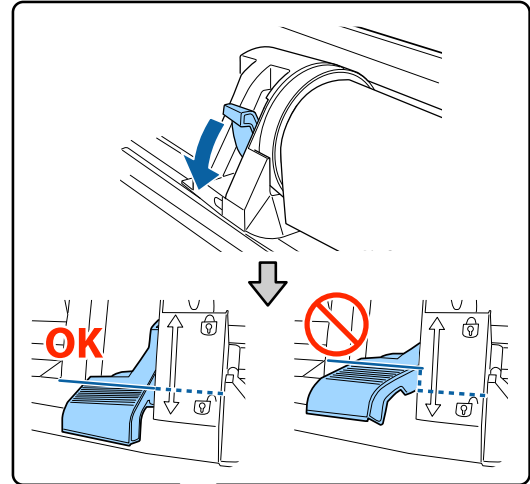

- 5** Move the adapter holder to the left.

When moving the adapter holder, make sure you use the handle.

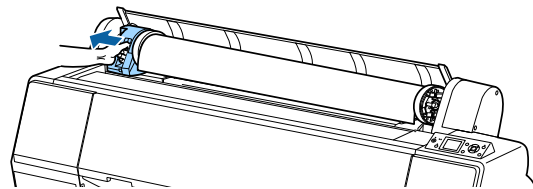

- 6** Roll over the paper roll to the front side to place it on the top of the printer.

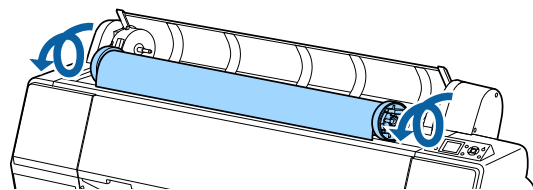

**Basic Operations**

- 7** Raise the adapter lock levers to release the locks, and remove the roll paper adapters from the roll paper.

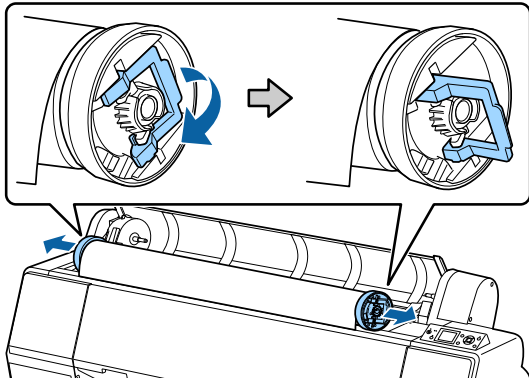

After rewinding the roll paper carefully, store it in the original package.

- 8** Close the roll paper cover.

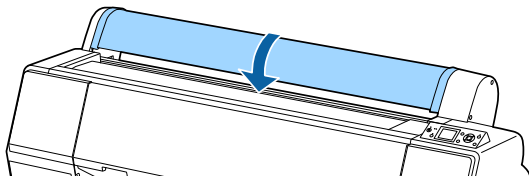

When continuing printing, press the  $\frac{1}{2}$  button on the control panel.

## Loading and Removing Cut Sheets

The loading method for cut sheets differs from paper that is A3 size or larger, poster board (paper that is thicker than 0.5 mm), and other paper.

[“Loading Cut Sheets A3 Size or Larger and Poster Board” on page 34](#)

[“Loading Cut Sheets Smaller than A3 Size” on page 36](#)

**Important:**

*If the paper is wavy or curled, use new paper. If wavy or curled paper is loaded, this printer may not be able to recognize the paper size, feed the paper, or print correctly.*

*We recommend that you return the paper to its original package and store it flat, and take it out of the package just before you use it.*

## Loading Cut Sheets A3 Size or Larger and Poster Board

**Important:**

- Insert the paper just before printing. The roller may leave an impression on paper that is left in the printer.*

- When roll paper is loaded, rewind the roll paper before loading the cut sheets.*

[“Removing Roll Paper” on page 32](#)

**Note:**

- The paper that can be used in the printer is detailed in the following section.*

[“Supported Media” on page 159](#)

- When paper has not been loaded in the printer, press the OK button to check the loading methods.*

## Basic Operations

Buttons that are used in the following settings

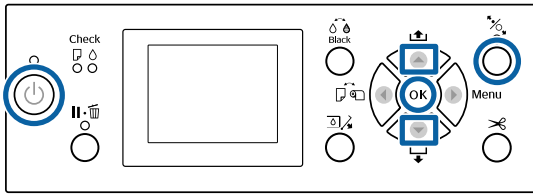

- 1 Turn on the printer by pressing the button.
- 2 Press the button, and then select **Cut Sheet** from the Paper Source menu.
- 3 Close the roll paper cover.

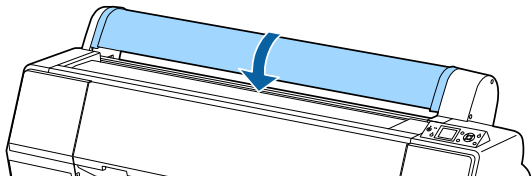

- 4 Press the button.  
The pressure roller is released.
- 5 Insert the paper until the trailing edge is below the loading mark on the roll paper cover.  
Normally, the paper should be loaded vertically.  
The printer supports thick paper up to 762 mm long. However, by loading paper horizontally, the SC-P9000 Series/SC-P8000 Series can handle thick paper that is longer than 762 mm.

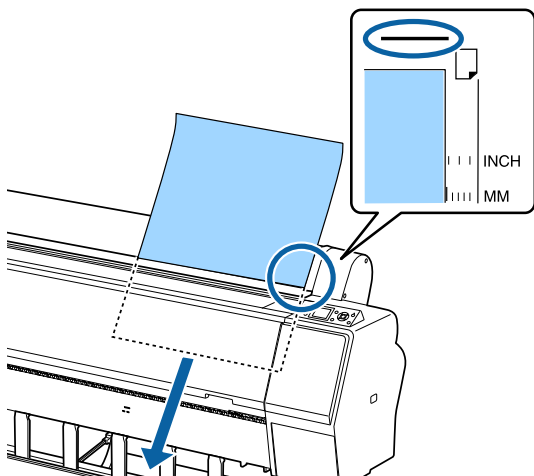

**Note:**  
For Epson Color Calibration Utility color charts, insert the page from the top with the printed side facing up.

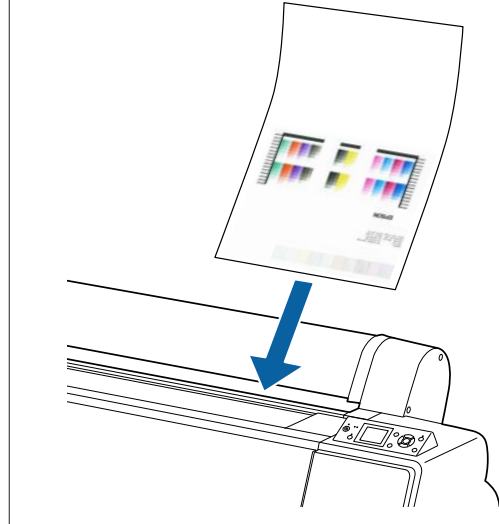

- 6 Position the trailing and right edges of the paper as shown by the loading mark.  
If it is hard to position thick paper, use the or buttons to adjust the suction strength.

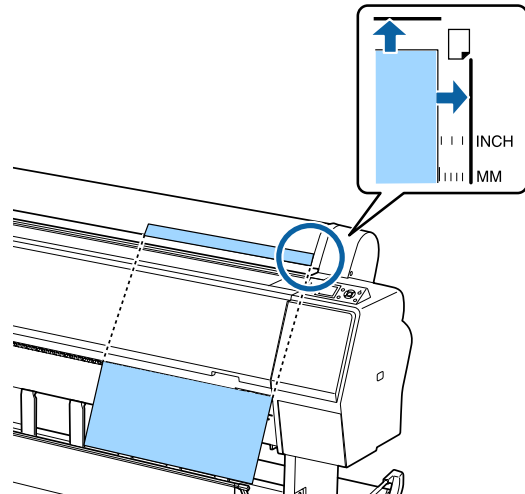

- 7 Press the button.  
The paper moves to the starting print position.
- 8 Check the media type.  
 [“Checking and Setting the Paper Type” on page 37](#)

Basic Operations

## Loading Cut Sheets Smaller than A3 Size

**Important:**

- ❑ Insert the paper just before printing. The rollers may leave impressions on paper that is left in the printer.
- ❑ When roll paper is loaded, rewind the roll paper before loading the cut sheets.  
[☞ “Removing Roll Paper” on page 32](#)

**Note:**

- ❑ The paper that can be used in the printer is detailed in the following section.  
[☞ “Supported Media” on page 159](#)
- ❑ When paper has not been loaded in the printer, press the OK button to check the loading methods.

Buttons that are used in the following settings

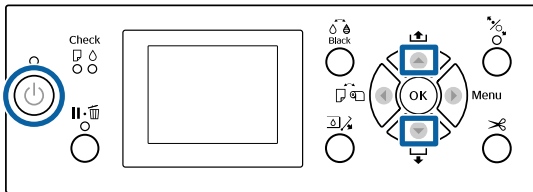

- 1 Turn on the printer by pressing the button.
- 2 Press the button, and then select **Cut Sheet** from the Paper Source menu.
- 3 Close the roll paper cover.

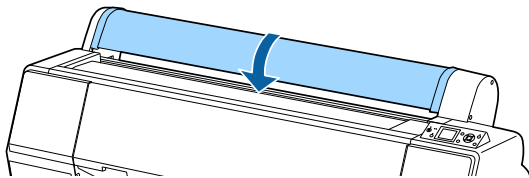

- 4 Insert the paper into the printer, keeping its right edge aligned with the loading mark on the roll paper cover.

**Important:**

Load cut sheets vertically.

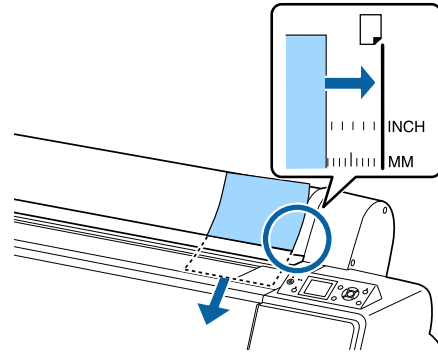

For paper smaller than A4 size, insert by keeping the right edge aligned with the additional line below the paper feed slot.

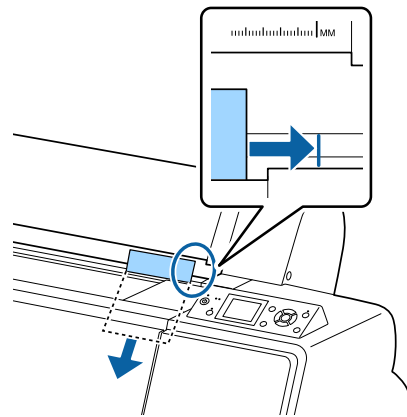

Press the button. is displayed on the screen.

- 5 Press the button.  
The paper moves to the starting print position.
- 6 Check the media type.  
[☞ “Checking and Setting the Paper Type” on page 37](#)

## Removing Cut Sheets

Buttons that are used in the following settings

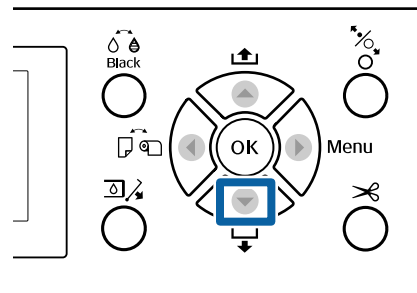

**Basic Operations**

- 1 Check the message displayed on the control panel's screen.  
**When Ready is displayed**  
 Press the ▼ button, and then feed the paper to the ejection position.

**Other messages**  
 Proceed to Step 2.

**! Important:**  
 Do not press the buttons when the power light or the pause light are flashing.

- 2 Press the ▼ button to take the paper.

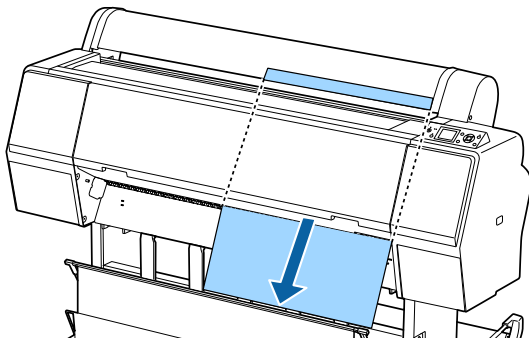

**! Important:**  
 Ejected paper may drop down. Make sure the leading edge of the paper is not damaged if it does drop.

## Checking and Setting the Paper Type

Before you start printing, check the paper loaded in the printer on the control panel's screen, and if it differs, make settings again. If you print using settings that do not match the paper type, you may not obtain optimum print results for the paper type.

### Checking the Paper Type

One of the following screens is displayed.



- Information screen**  
 This is displayed when loading roll paper that does not have a printed barcode, or when loading cut sheets. Follow the steps below and then make settings.  
 ➔ [“Paper Type Settings” on page 38](#)
- Ready Screen**  
 This is displayed when loading roll paper that has a printed barcode. The barcode is read automatically, and the paper type and amount remaining are displayed. You can start printing quickly.

**Note:**  
 When **Roll Paper Remaining - Remaining Setup** is set to **On** from the Paper menu, a barcode is printed automatically on the edge of the paper when the roll paper is removed. The barcode is automatically read and settings adjusted the next time the paper is used, improving efficiency when multiple rolls of paper are used.  
 ➔ [“Paper” on page 116](#)

**Basic Operations**

**Paper Type Settings**

Buttons that are used in the following settings

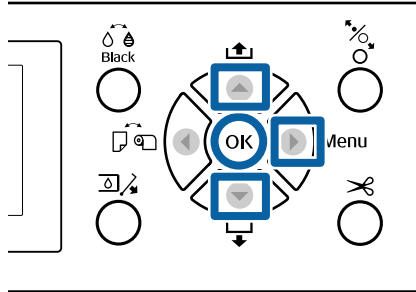

**1** Check the content displayed on the screen.

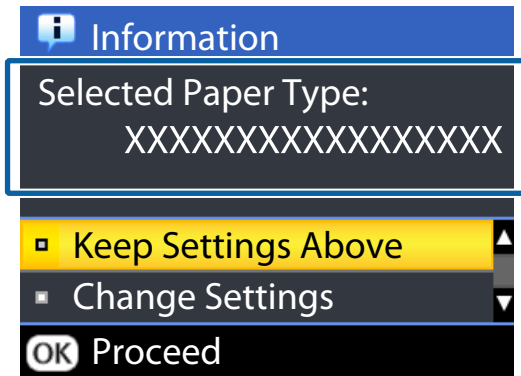

**When changing settings and printing**  
Use the ▼/▲ buttons to select **Change Settings**, and then press the OK button. Next, proceed to Step 2.

**When printing using the current settings**  
With **Keep Settings Above** selected, press the OK button, and then proceed to Step 4.

**When using commercially available paper for the first time**  
You need to register custom paper information. With **Keep Settings Above** selected, press the OK button, and then proceed to Step 4.

**2** Select the Paper Type, and then press the OK button.

**3** Select the media name, and then press the OK button.

**4** When **Remaining Setup** is set to **On**, use the ▼/▲ buttons to set the roll paper length to 5.0 to 99.5 m, and then press the OK button.

You can set in increments of 0.5 m.

**5** Check that **Ready** is displayed on the screen.

**When printing immediately**  
Send the print data from the computer.

**When using commercially available paper for the first time**  
Make custom paper settings.

[“Before Printing on Commercially Available Paper” on page 177](#)

**Note:**

*When printing using the printer driver and the paper settings on the printer and the printer driver do not match, the following occurs.*

- When genuine Epson media is loaded in the printer: The printer driver settings are used.*
- When custom paper is loaded in the printer: The printer settings are used.*

**Basic Operations**

# Using the Paper Basket

Using the paper basket allows you to print smoothly by preventing the paper from getting dirty or wrinkled. Paper basket usage differs depending on the paper specifications.

**Ejecting paper to the rear (for normal printing)**

Ejected paper is collected in the paper basket.

This is available for roll paper or cut sheets that meet the following specifications.

	SC-P9000 Series/ SC-P8000 Series	SC-P7000 Series/ SC-P6000 Series
Thickness	Less than 0.5 mm	Less than 0.5 mm
Paper Length	Less than 1580 mm	Less than 914.4 mm

**! Important:**

*Normally the capacity of the paper basket should be one sheet at a time.*

*When collecting more than one sheet of paper at a time, the gap between the paper support and the paper basket is reduced, and the paper may not be ejected correctly.*

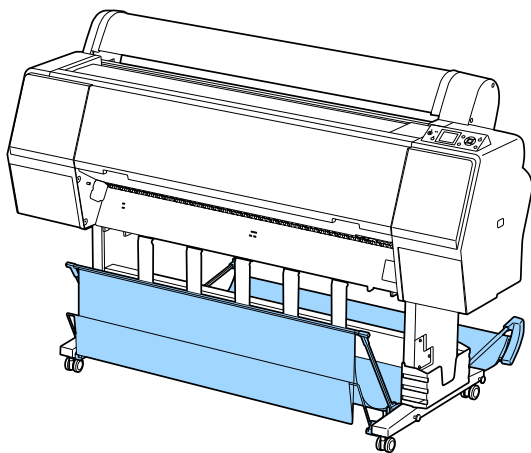

See the following for the paper ejection method to the rear of the printer.

[“Ejecting Paper to the Rear” on page 39](#)

**Ejecting paper to the front of the printer (for banner printing and printing on thick paper)**

When performing banner printing on roll paper or printing on thick cut sheets, eject paper to the front of the printer.

This is available for roll paper or cut sheets that meet the following specifications.

	SC-P9000 Series/ SC-P8000 Series	SC-P7000 Series/ SC-P6000 Series
Thickness	0.5mm or more	0.5mm or more
Paper Length	1580mm or more	914.4mm or more

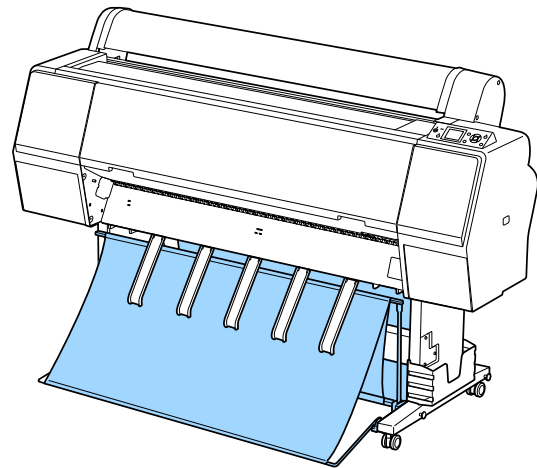

See the following for the paper ejection method from the front of the printer.

[“Ejecting Paper to the Front” on page 41](#)

## Ejecting Paper to the Rear

This section explains how to switch the paper basket from the stored state to the ready state.

### Basic Operations

- 1** Raise the paper supports to the horizontal position.

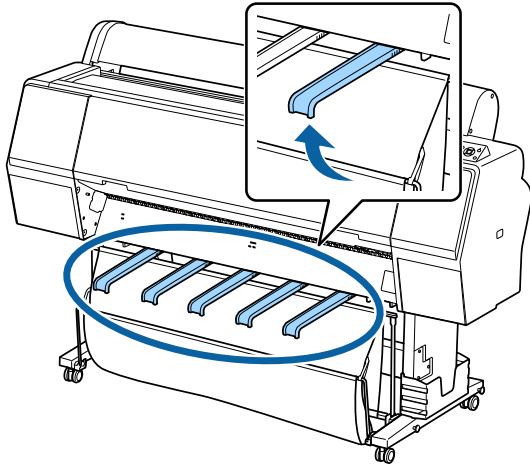

- 2** Lower the paper basket at the front until it is level with the floor.

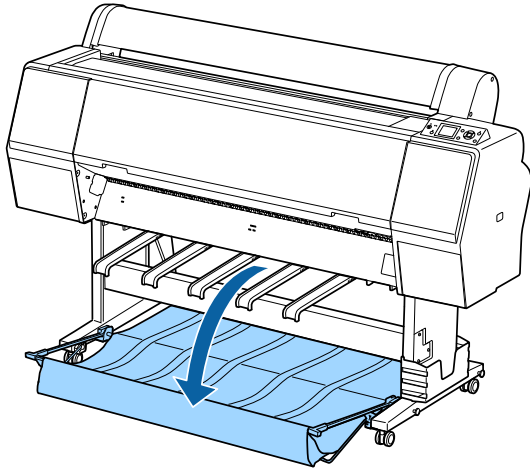

- 3** Lower the paper supports while pressing the left and the right sides until the supports are vertical as shown in the illustration.

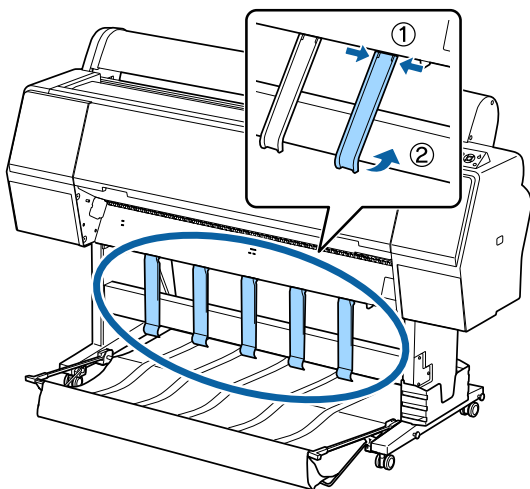

- 4** Carefully raise the basket at the front by one level.

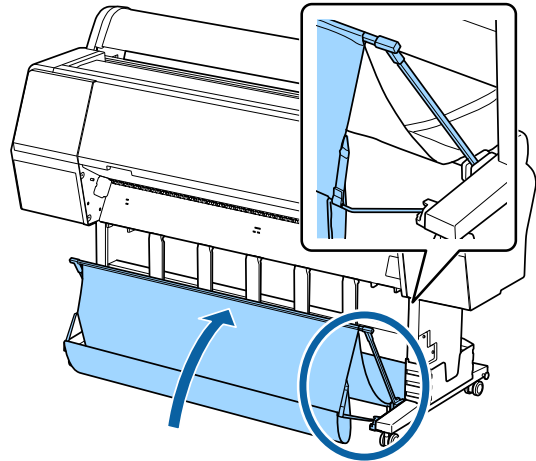

When the cloth touches the floor, secure using the hook and loop fastener tape as shown in the illustration.

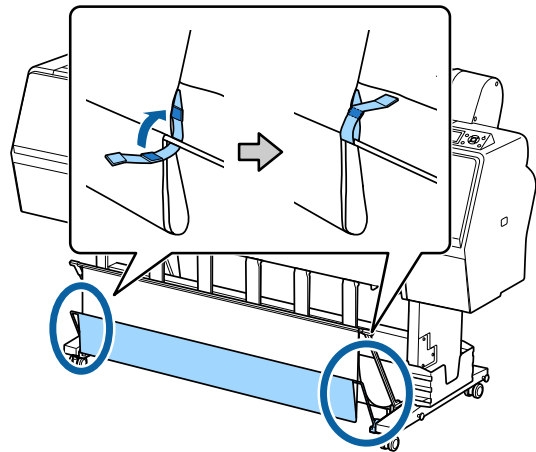

**Important:**

*If image quality is smudged in Doubleweight Matte Paper or Enhanced Matte Paper, raise all paper supports by one level.*

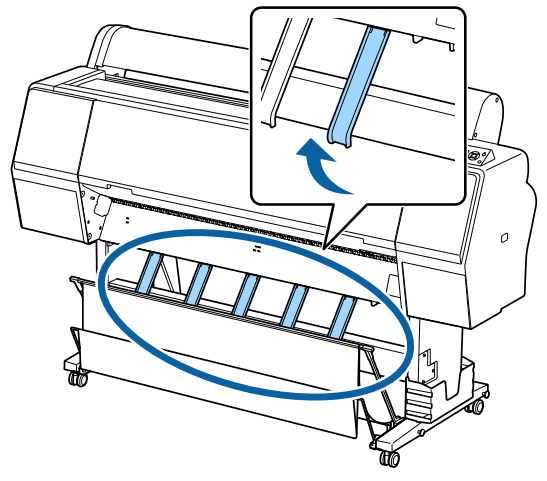



### Basic Operations

**Note:**

For Enhanced Matte Paper, when the front basket is level with the floor the basket can hold multiple, continuous print outs. However, the image quality may be smudged, damaged, or soiled.

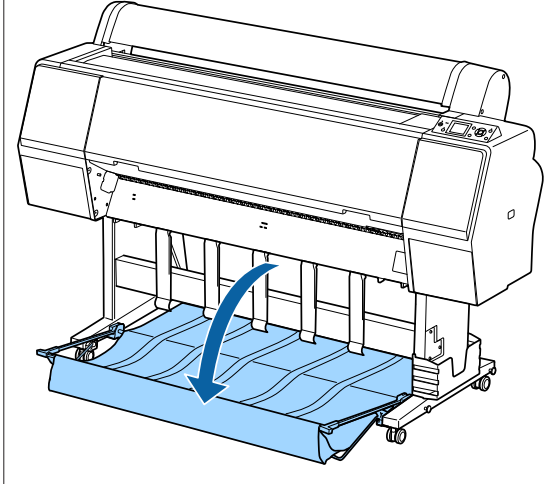

For the SC-P9000 Series/SC-P8000 Series, proceed to Step 5.

For the SC-P7000 Series/SC-P6000 Series, this completes this section.

- 5** Switch the position of the basket at the rear according to the length of the print outs.

**When the paper length is 1,189 mm (A1 length) or less**

Raise the basket so that it is straight up.

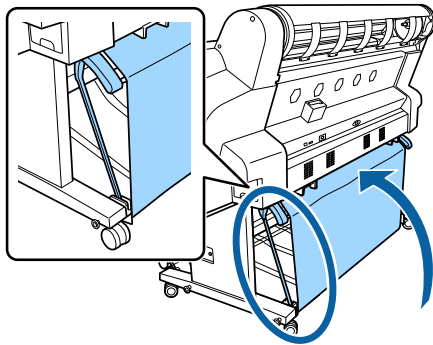

**When the paper length is 1,189 mm (A1 length) or more**

Lay the basket straight out.

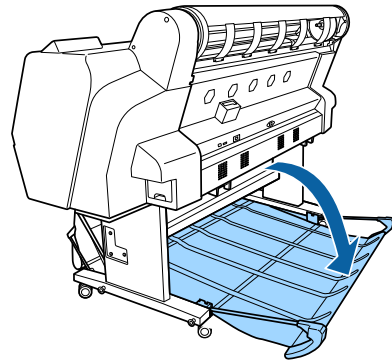

### Ejecting Paper to the Front

This section explains how to switch the paper basket from the stored state to the ready state.

- 1** Raise the paper supports to the horizontal position.

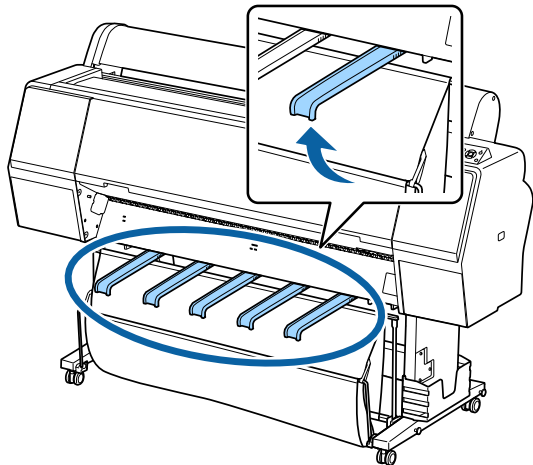

- 2** Remove the hook and loop fastener tape.

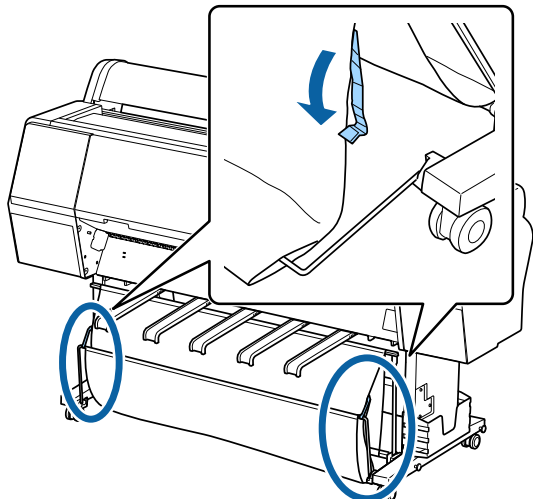

## Basic Operations

- 3** Raise the front basket so that is vertical.  
Make sure the cloth is pulled tight.

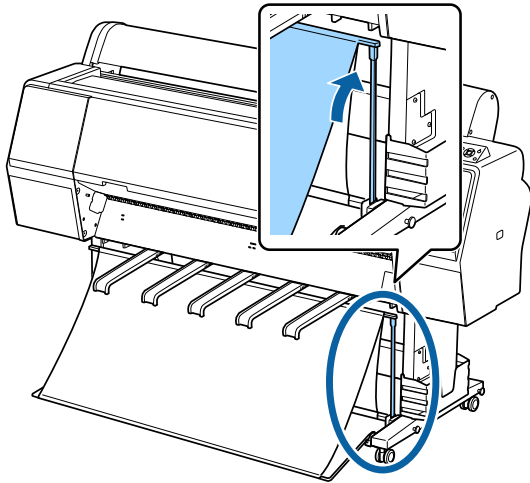

- 4** Lower the paper supports while pressing left and right as shown in the illustration until they touch the cloth.

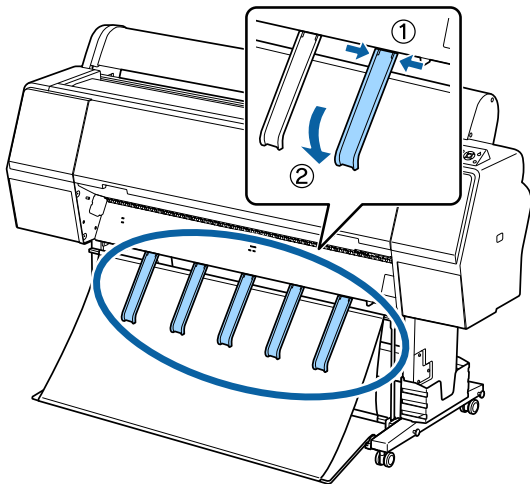

### Front

Place the paper supports in the position shown in the illustration to prevent the front paper basket from falling to the floor and getting soiled.

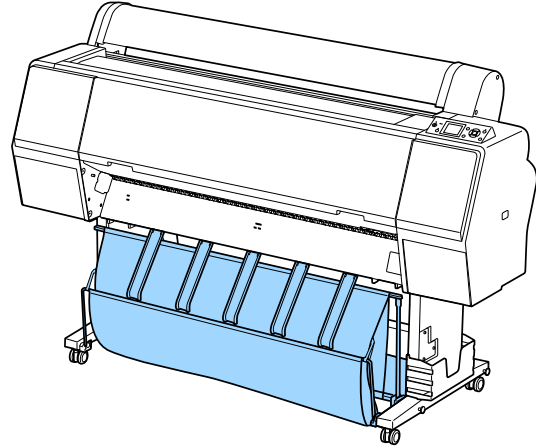

### Back

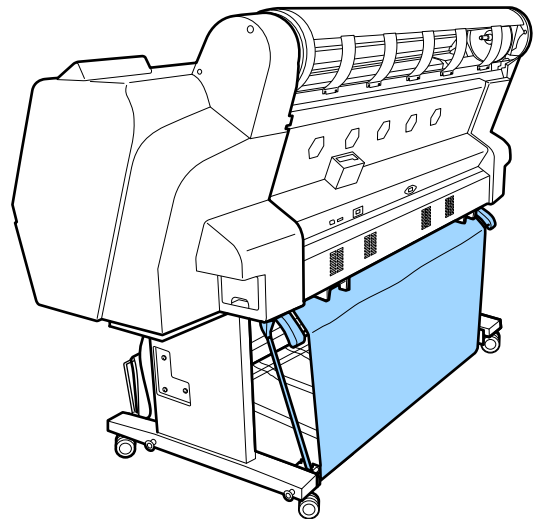

## Storing

Store the paper basket before loading paper or moving the printer.

When storing, perform each ejection procedure in reverse, and store the front and rear paper baskets vertically as shown in the illustration.

 [“Ejecting Paper to the Rear” on page 39](#)

 [“Ejecting Paper to the Front” on page 41](#)

**Basic Operations**

# Using the Auto Take-up Reel Unit (SC-P9000 Series/SC-P8000 Series Only)

The optional auto take-up reel unit automatically takes up paper as it is printed. It improves efficiency for banners or large jobs involving continuous printing on roll paper.

The auto take-up reel unit for this printer can take up paper in either of the directions shown below. Some types of paper may not support one or the other of these directions or may place restrictions on the take-up direction.

See the following section for information on take-up support and take-up direction.

[“Epson Special Media Table” on page 159](#)

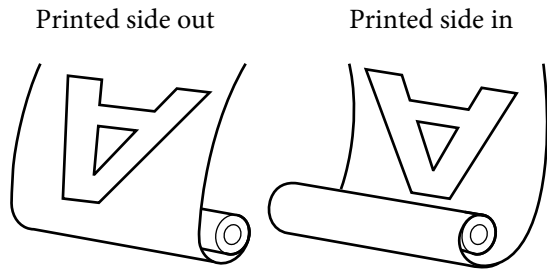

Taking-up with printed side out places the printed surface on the outside of the roll.

Taking-up with printed side in places the printed surface on the inside of the roll.

**Caution:**

- ❑ Fix the roll core for the auto take-up reel unit in place as described in the documentation. Dropping the roll core could cause injury.
- ❑ Be careful that your hands, hair, or other objects do not get caught in the moving parts of the auto take-up reel unit. Failure to observe this precaution could result in injury.

**Important:**

Confirm that the end of the roll is cut straight across. The unit will not function as expected if the end of the roll is wavy or curved.

[“Manual cut method” on page 32](#)

**Note:**

For information on installing the auto take-up reel unit, see the documentation supplied with the auto take-up reel unit.

## Using the Control Panel

This section describes how to use the control panel for the auto take-up reel unit.

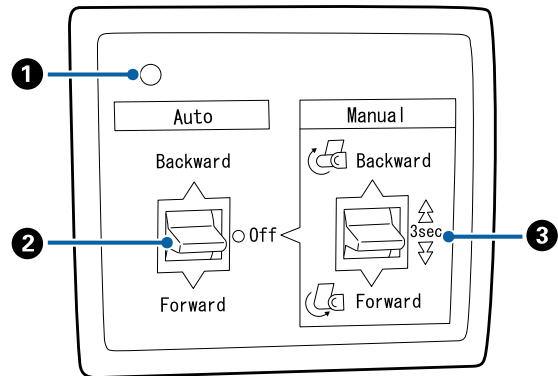

- 1 Power lamp**  
Displays the status of the auto take-up reel unit.
- On : The auto take-up reel unit is ready for use.
  - Flickering : The auto take-up reel unit is in use.
  - Blinking : The auto take-up reel unit is in power-saving mode.
  - Intermittent blinking : An error has occurred.
  - Off : The power is off.
- 2 Auto switch**  
Selects the auto take-up direction.

## Basic Operations

**Backward** : The roll is taken up with the printable side in.

**Forward** : The roll is taken up with the printable side out.

**Off** : The auto take-up reel unit does not take up paper.

### 3 Manual switch

Selects the manual take-up direction.

The selected option takes effect when the Auto switch is in the Off position.

**Backward** : The roll is taken up with the printable side in.

The speed will increase after the button is pressed for more than three seconds.

**Forward** : The roll is taken up with the printable side out.

The speed will increase after the button is pressed for more than three seconds.

## Attaching the Paper

This section describes how to attach roll paper to the auto take-up reel unit roll core.

The procedure varies with the take-up direction.

### ! Important:

Before proceeding, select **Off** for **Auto Cut**. Using the auto take-up reel unit when **On** is selected will cause errors.

 ["Cutting the roll paper" on page 31](#)

## Taking Up the Paper Printable Side Out

For information on installing the roll core, see the *Setup Guide* for the optional auto take-up reel unit.

Buttons that are used in the following settings

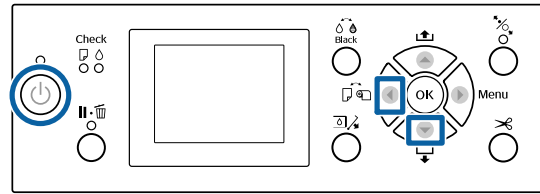

- 1 Set the auto take-up reel unit Auto switch to Off. Plug the power cord into an outlet and confirm that the power lamp lights.

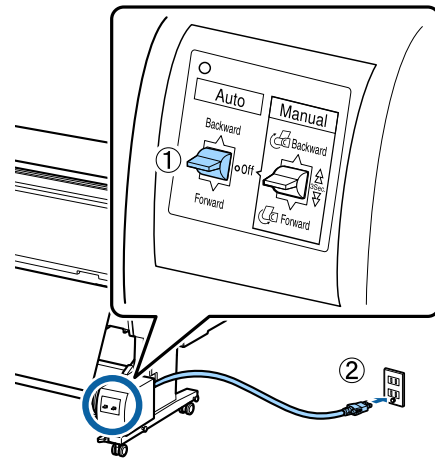



- 2 Press the  button to turn on the printer.

- 3 Check that the roll paper is correctly loaded in the printer.

- 4 Check that the auto take-up reel unit icon is displayed on the printer's screen.

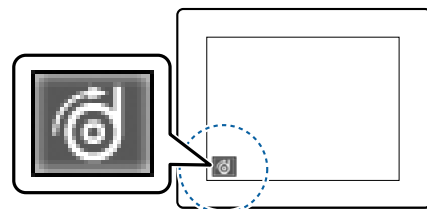
If the icon is not displayed, check that the auto take-up reel unit is connected correctly and is turned on.



- 5 Press the  button on the printer, and then select **Roll Paper** from the Paper Source menu.

- 6 Keep the  button on the printer pressed until the end of the roll reaches the roll core.

## Basic Operations

7

Tape the end to the roll core.

Place tape (available from third-party suppliers) at the center and then at the left and right ends.

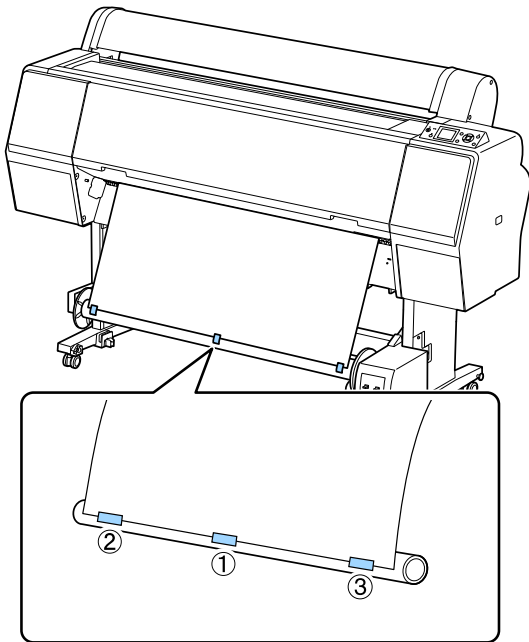

8

Keep the ▼ button in the printer pressed until you have fed enough paper for about three wraps around the roll core.

9

Keep the Manual switch on the auto take-up reel unit pressed to Forward to wrap the paper three times around the core.

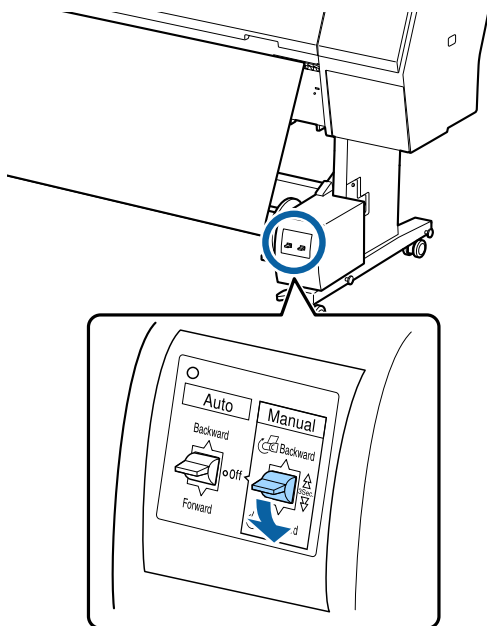

After wrapping the paper around the core, ensure that paper around the core is sufficiently loose.

**Note:**

The tensioner supplied with the auto take-up reel unit is used with some types of paper. Slacken the paper and insert the tensioner near the center of the paper as shown. See the following section for information on paper that requires the tensioner.

☞ “Epson Special Media Table” on page 159

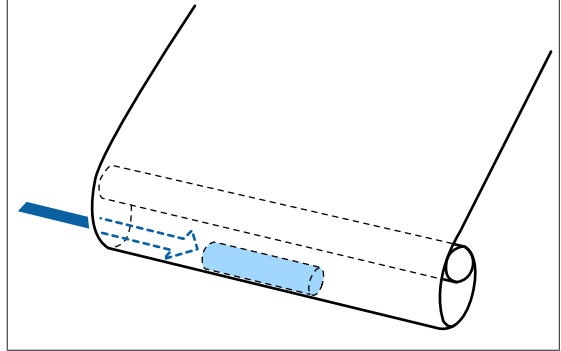

10

Set the auto take-up reel unit Auto switch to Forward.

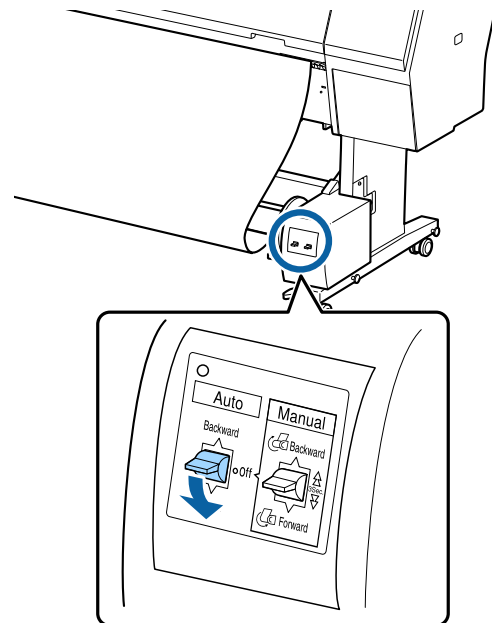

## Taking Up the Paper Printable Side In

For information on installing the roll core, see the *Setup Guide* for the optional auto take-up reel unit.

Buttons that are used in the following settings

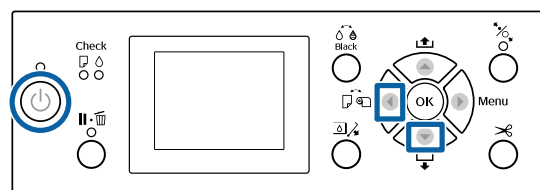

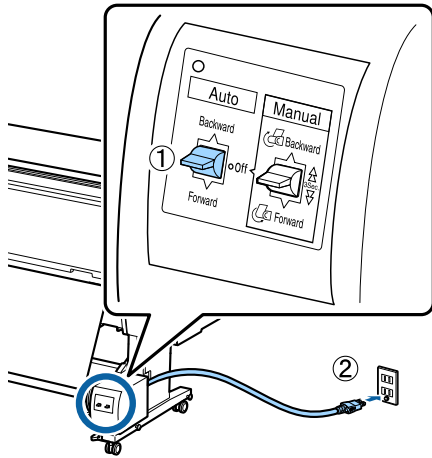

## Basic Operations

- 1 Set the auto take-up reel unit Auto switch to Off. Plug the power cord into an outlet and confirm that the power lamp lights.



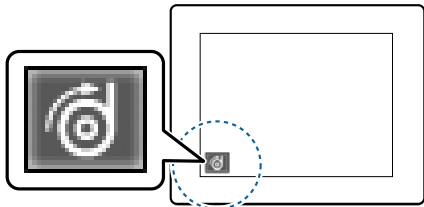

- 2 Press the  button to turn on the printer.
- 3 Check that the roll paper is correctly loaded in the printer.
- 4 Check that the auto take-up reel unit icon is displayed on the printer's screen. If the icon is not displayed, check that the auto take-up reel unit is connected correctly and is turned on.

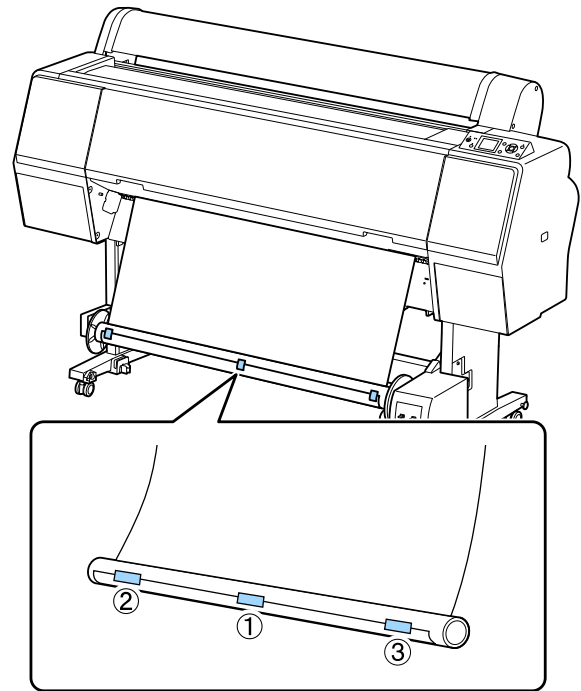

- 5 Press the  button on the printer, and then select **Roll Paper** from the Paper Source menu.
- 6 Keep the  button on the printer pressed until the end of the roll reaches the roll core.

- 7 Tape the end to the roll core. Place tape (available from third-party suppliers) at the center and then at the left and right ends.



- 8 Keep the  button in the printer pressed until you have fed enough paper for about three wraps around the roll core.
- 9 Keep the Manual switch on the auto take-up reel unit pressed to Backward to wrap the paper three times around the core.

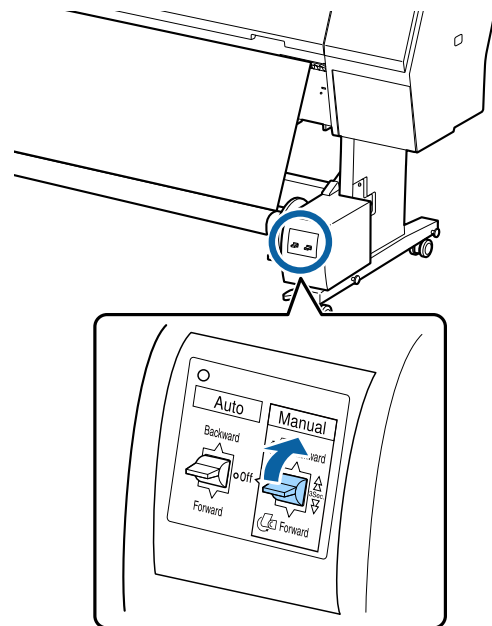

## Basic Operations

After wrapping the paper around the core, ensure that paper around the core is sufficiently loose.

- 10** Set the Auto switch to Backward.

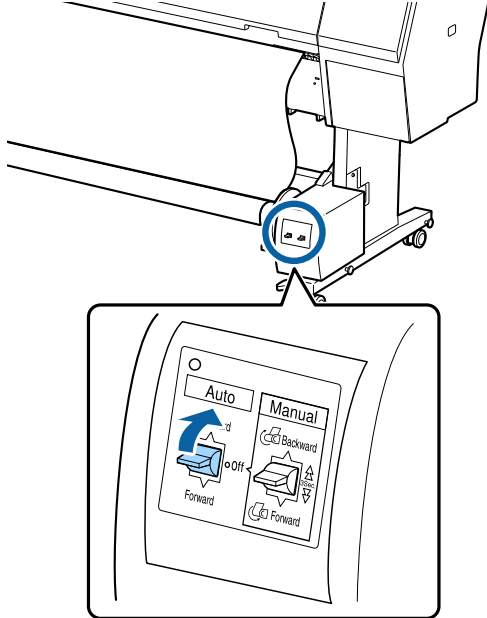

## Removing Paper from the Auto Take-up Reel Unit

This section describes how to remove paper from the auto take-up reel unit.

**⚠ Caution:**

*Removing paper from the auto take-up reel unit requires two workers, one on each end of the roll.*

*A single worker working by his or herself could drop the roll, resulting in injury.*

- 1** Set the auto take-up reel unit Auto switch to Off.

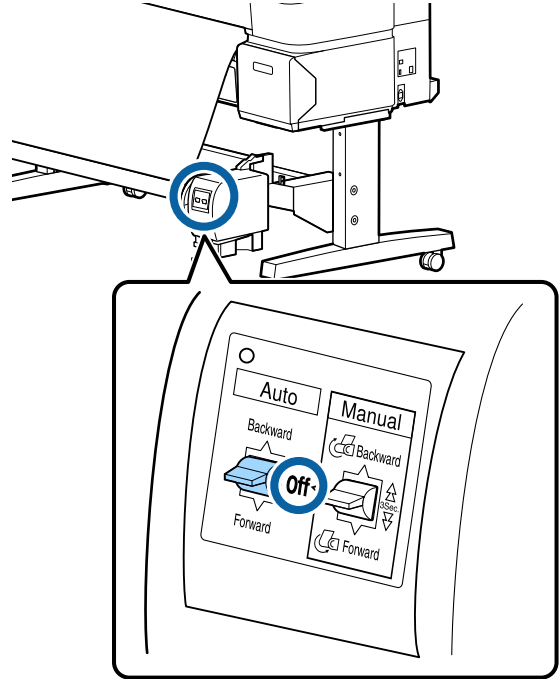

- 2** Cut the paper and take it up until it is all on the auto take-up reel unit roll core.

✍ “Manual cut method” on page 32

After cutting the paper, support the end to prevent the printed surface touching the floor; continue to support the paper until it is all taken up. Keep the Manual switch pressed in the take-up direction (either Forward or Backward).

- 3** Unlock the movable unit and remove it from the roll core.

When removing the movable unit, support the roll core with one hand to prevent it falling to the floor.

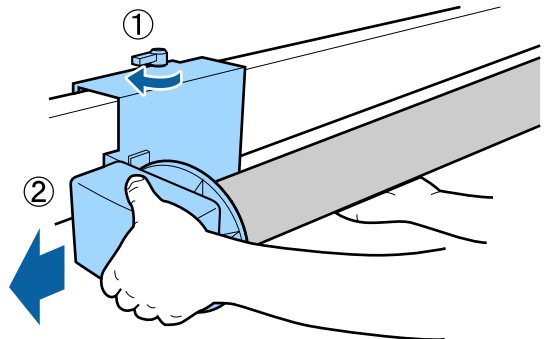

## Basic Operations

- 4** Remove the roll core from the auto take-up reel unit.

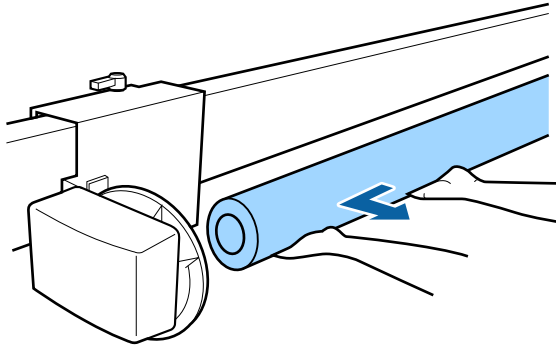



## Basic Printing Methods

This section explains how to print and how to cancel printing.

### Printing (Windows)

Make print settings such as paper size and paper source from the connected computer and then print.

- 1** Turn on the printer, and load the paper.
  -  [“Loading and Removing the Roll Paper” on page 28](#)
  -  [“Loading and Removing Cut Sheets” on page 34](#)
- 2** When you have created the data, click **Print** in the **File** menu.

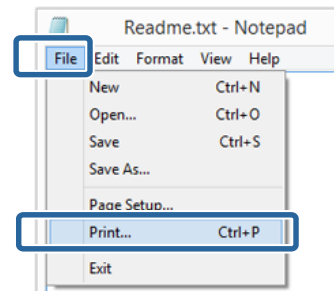

- 3** Make sure your printer is selected, and then click **Preferences** or **Properties** to display the settings screen.

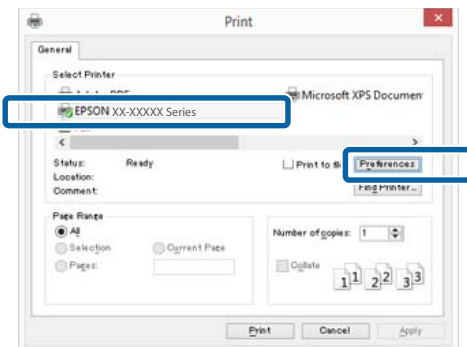



## Basic Operations

- 4** Select the **Media Type**, **Color**, **Print Quality**, **Mode**, and **Source** according to the paper loaded in the printer.

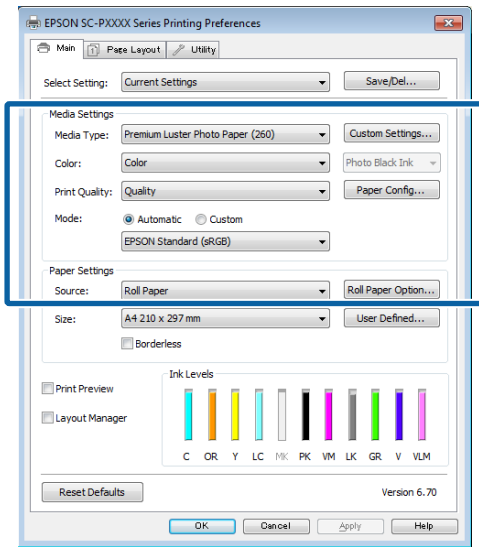

- 5** Make sure you select the same **Size** as you set in the application.

After making the settings, click **OK**.

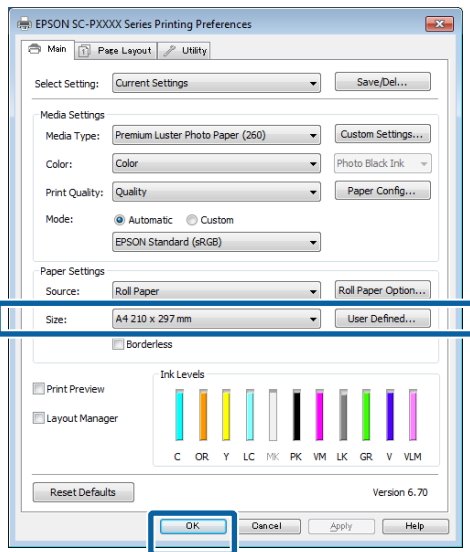

- 6** When settings are complete, click **Print**.

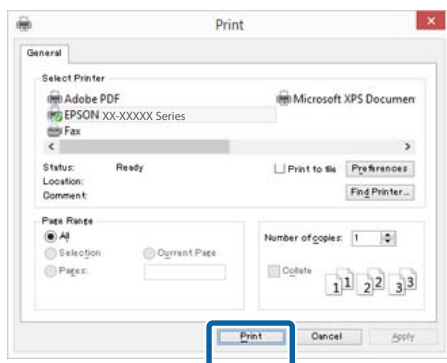

The progress bar is displayed, and printing starts.

### Screen while printing

The following screen is displayed when you start printing, and the progress bar (the computer's processing status) is displayed. On this screen you can check the remaining ink level, product numbers for the ink cartridges, and so on.

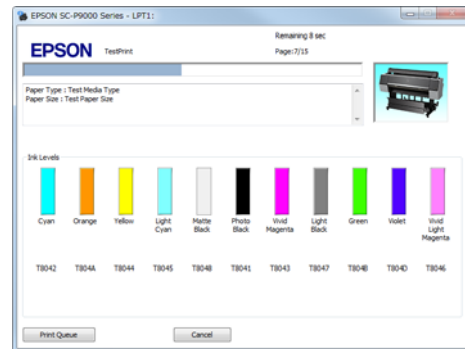

An error message is displayed if an error occurs or an ink cartridge needs replacing while printing.



## Printing (Mac OS X)

Make print settings such as paper size and paper source from the connected computer and then print.

- 1** Turn on the printer, and load the paper.
- [“Loading and Removing the Roll Paper” on page 28](#)
  - [“Loading and Removing Cut Sheets” on page 34](#)

## Basic Operations

- 2** When you have created the data, from the **File** menu of the application, click **Print** and so on.

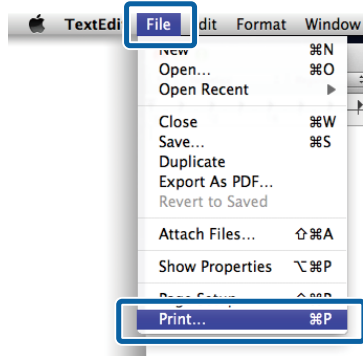

- 3** Click **Show Details** at the bottom of the screen.

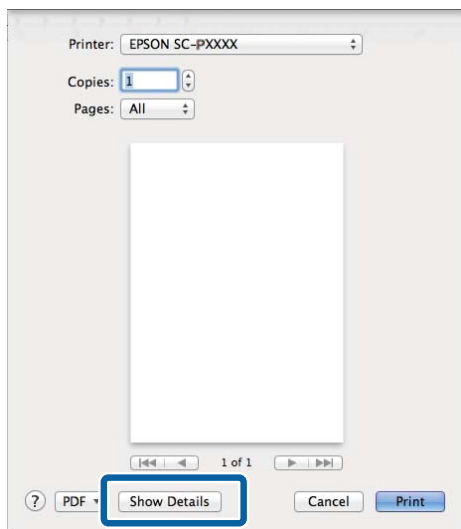

For Mac OS X v10.6.8, click the arrow (▼) on the right of the printer name to make settings on the Page Setup screen.

**Note:**

If page settings are not displayed in the print dialog, click the "page settings" option (e.g., **Page Setup**) in the **File** menu.

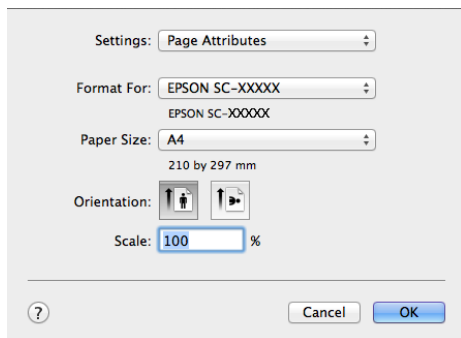

- 4** Check that this printer is selected, and then set the paper size.

Select the paper size, borderless printing options, and paper source in the **Paper Size** menu.

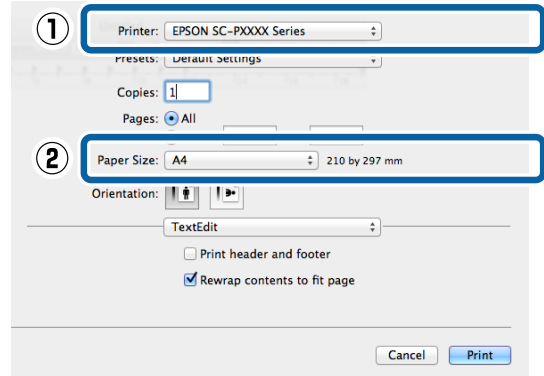

- 5** Select **Print Settings** from the list, and then set each item.

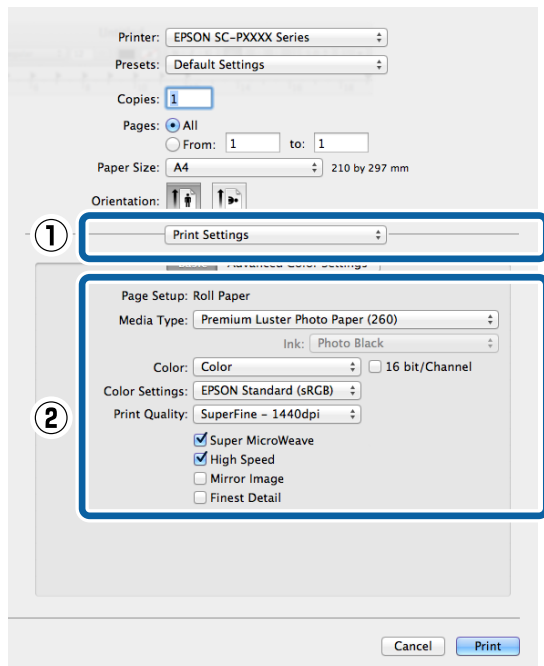

Set the **Media Type**, **Color**, **Print Quality**, and other settings according to the type of paper loaded in the printer. Normally, you can print correctly just by setting items in the **Print Settings** screen.

- 6** When settings are complete, click **Print**.

The printer icon is displayed in the Dock while printing. Click the printer icon to display the status. You can check the progress of the current print job and the printer status information. You can also cancel a print job.

## Basic Operations

Also, if an error occurs while printing, a notification message is displayed.

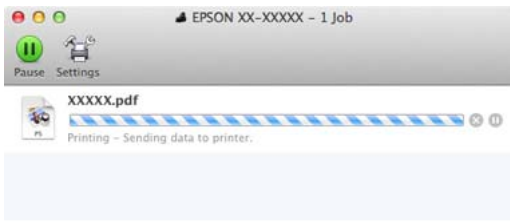

## Canceling Printing (Windows)

When the computer has finished sending data to the printer, you cannot cancel the print job from the computer. Cancel on the printer.

➔ “Canceling Printing (from the Printer)” on page 52

**When the progress bar is displayed**  
Click **Cancel**.

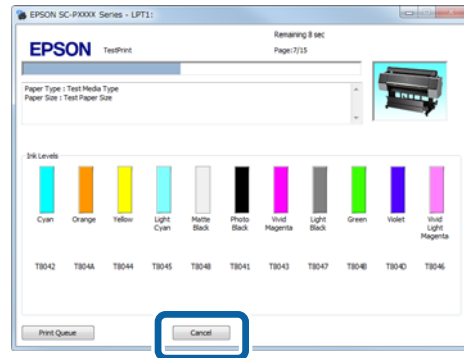

**When the progress bar is not displayed**

**1** Click the printer icon on the Taskbar.



Whether or not an icon is displayed depends on the settings selected for Windows.

**2** Select the job you want to cancel, and then select **Cancel** from the **Document** menu.

To cancel all jobs, click **Cancel All Documents** in the **Printer** menu.

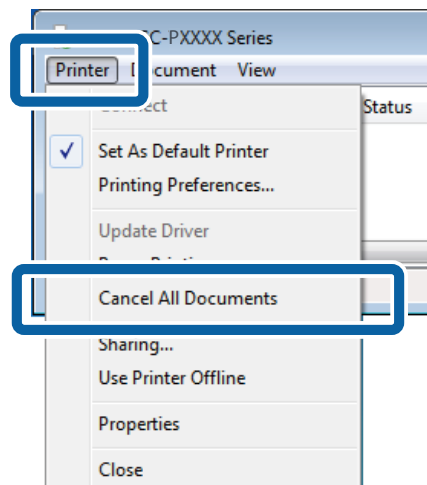

## Basic Operations

If the job has been sent to the printer, print data is not displayed on the above screen.

### Canceling Printing (Mac OS X)

When the computer has finished sending data to the printer, you cannot cancel the print job from the computer. Cancel on the printer.

☞ “Canceling Printing (from the Printer)” on page 52

- 1 Click the printer icon in the Dock.



- 2 Select the job you want to cancel, and then click **Delete**.

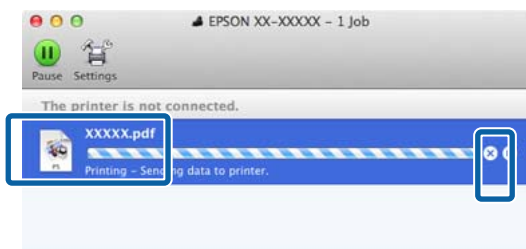

If the job has been sent to the printer, print data is not displayed on the above screen.

### Canceling Printing (from the Printer)

Press the **II** button, select **Job Cancel** on the screen, and then press the **OK** button.

The print job is canceled even in the middle of printing. It may take a while before the printer returns to ready status after canceling a job.

**Note:**

Note: You cannot delete print jobs which are in the print queue on the computer using the above operation. See "Canceling Printing (Windows)" or "Canceling Printing (Mac OS X)" in the previous section for information on deleting print jobs from the print queue.

## Printable area

This section describes the printable areas for the printer.

If the margin set in an application is larger than the following setting values, sections beyond the specified margins are not printed. For example, if 15 mm is selected for the left and right margins in the printer menus and the document fills the page, the 15 mm at the left and right sides of the page will not be printed.

### Roll Paper Printable Area

The gray area in the illustration below shows the printable area.

The arrow in the illustration indicates the direction of the ejected paper.

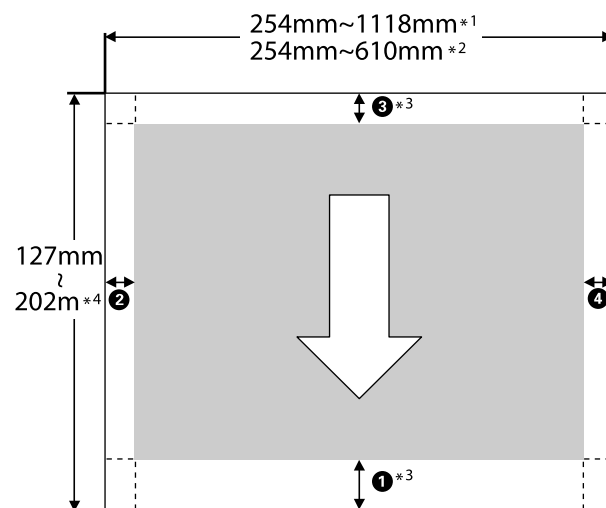

\*1 SC-P9000 Series/SC-P8000 Series

\*2 SC-P7000 Series/SC-P6000 Series

\*3 Selecting **Roll Paper (Banner)** from **Source** in the printer driver sets the top and bottom margins of the paper to 0 mm.

### Basic Operations

\*4 The printer driver supports the following maximum paper lengths.

Windows: 15 m (590.6 inch)

Mac OS X: 15 m 24 cm (600 inch)

When printing on paper longer than this, you need commercially available banner printing software. In this situation, select **Roll Paper (Banner)** from **Source** in the printer driver.

① to ④ in the illustration indicates the margins at the top, bottom, left, and right.

For borderless printing, the following values are set to 0 mm.

- Left and right borderless printing: ②, ④
- Borderless printing on all sides: ①, ②, ③, ④

Margins in other situations depends on the option selected for **Roll Paper Margin** in the menus, as shown in the table below.

#### Roll Paper Margin Settings "Paper" on page 116

 indicates factory default settings.

Roll Paper Margin Parameter	Margin Values
Normal	①,③=15 mm*
	②,④=3 mm
Top15mm/Bottom15mm	①,③=15mm
	②,④=3 mm
Top35mm/Bottom15mm	①=35 mm
	③=15mm
	②,④=3 mm
Top150mm/Bottom15mm	①=150mm
	③=15mm
	②,④=3 mm
3mm	①,②,③,④=3 mm

Roll Paper Margin Parameter	Margin Values
15mm	①,②,③,④=15mm

\* When **Normal** is selected, the value for ① is 20 mm for the following paper.

Premium Glossy Photo Paper (250)/Premium Semigloss Photo Paper (250)/Premium Luster Photo Paper (260)/Premium Semimatte Photo Paper (260)

Also, when using Enhanced Adhesive Synthetic Paper, the value for ① is 100 mm.

#### Important:

- Printing is distorted when the trailing edge of the roll paper comes off the core. Make sure the trailing edge does not come inside the printing area.
- The print size does not change even when the margins are changed.

### Cut Sheets Printable Area

The gray area in the illustration below shows the printable area. The arrow in the illustration indicates the direction of the ejected paper.

When printing borderless on the left and right, the left and right margins are 0 mm.

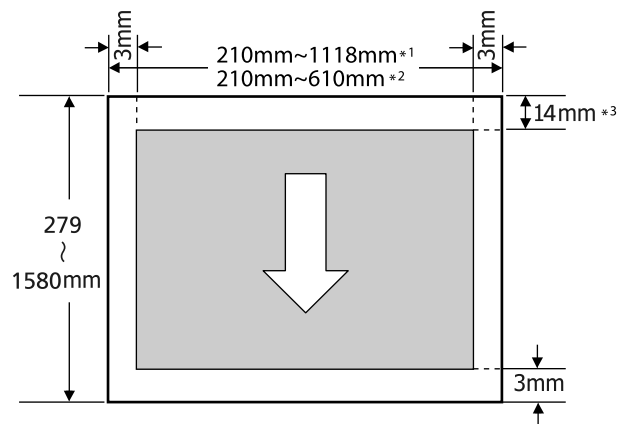

\*1 SC-P9000 Series/SC-P8000 Series

\*2 SC-P7000 Series/SC-P6000 Series

## Basic Operations

- \*3 15.5 mm when printing Enhanced Matte Poster Board

# Changing the Type of Black Ink

This printer allows you to set both photo black ink and matte black ink and switch between them depending on the paper type.

Photo Black ink reduces the grainy feeling of photo papers giving them a smooth, professional finish. Matte Black ink significantly increases black optical density when printing on matte type papers.

See the following section to select a suitable black ink for the media type.

 [“Epson Special Media Table” on page 159](#)

**Note:**

*If there is not enough ink remaining for the switch, you will need to replace the cartridge. It may be possible to print with ink cartridges that could not be used for a black ink switch.*

---

## Switching Automatically

You can switch black inks and print from the printer driver.

Set **Auto Black Ink Change** to **On** from the Printer Setup menu in advance.

 [“Printer Setup” on page 120](#)

**1**

Display the printer driver's Main screen.

 [“Printing \(Windows\)” on page 48](#)

 [“Printing \(Mac OS X\)” on page 49](#)

**2**

Select the paper type from the **Media Type** menu.

Depending on the media type you select, black ink is switched automatically during printing.

## Basic Operations

### Windows

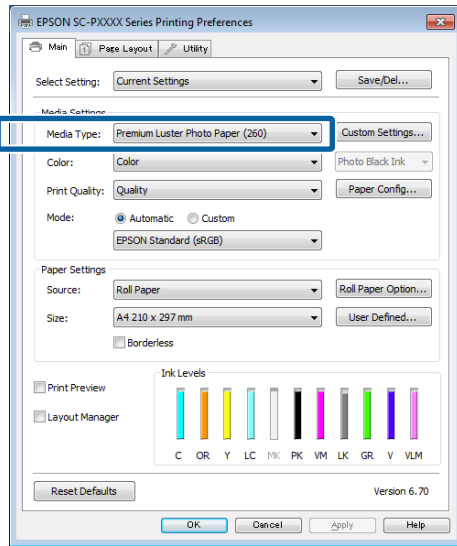

### Mac OS X

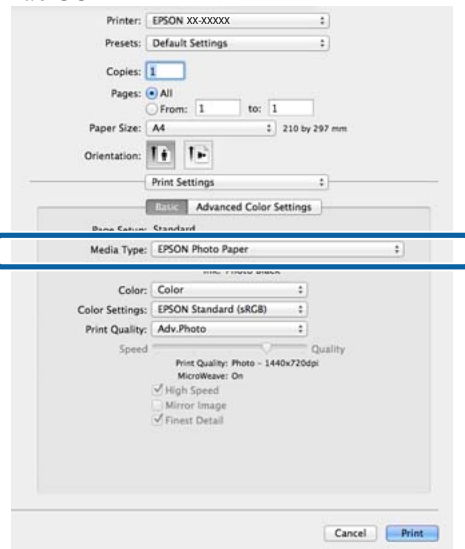

**Note:**



- ❑ The black ink type that can be used for printing varies depending on the media type.
- ❑ You can select the type of black ink from the printer driver when the media type selected supports both photo black and matte black.  
[🔗 “Supported Media” on page 159](#)
- ❑ If the printer status cannot be acquired, the black ink type may change automatically.

## Switching Manually

Change from the control panel.

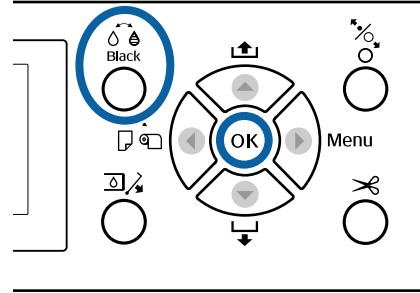
Buttons that are used in the following settings



- 1 Turn on the printer by pressing the  button.
- 2 Press the  button.  
 Follow the on-screen instructions.

- 3 Check other settings, and then start printing.

## Basic Operations

# Turning Off the Power Using Power Off Timer

The printer offers the following two power management options.

### Sleep mode

The printer enters sleep mode when there are no errors, no print jobs being received, and no control panel or other operations performed. When the printer enters sleep mode, the control panel's screen turns off and the internal motors and other parts switch off to consume less power.

Sleep mode is cleared if a print job is received or a button on the control panel is pressed.

The delay before the printer enters sleep mode can be selected from values between 5 and 210 minutes. At default settings, the printer enters sleep mode if no operations are performed for 15 minutes. The delay can be changed from the Preferences menu.

 [“Preferences” on page 123](#)

**Note:**

*When the printer enters sleep mode, the control panel's screen goes blank as if the power has been turned off, but the  light remains lit.*

### Power Off Timer

The printer is equipped with a Power Off Timer option that automatically turns the printer off if no errors occur, no print jobs are received, and no control panel or other operations are performed for a set period of time. The delay before the printer turns off automatically can be selected from values between 1 and 24 hours in increments of 1 hour.

The default setting is 8 hours.

The printer turns off automatically if no errors occur, no print jobs are received, and no operations on the panel or other operations are performed for eight hours or longer.

Power Off Timer settings can be adjusted from the Preferences menu.

 [“Preferences” on page 123](#)

### About Power Management

You can adjust the time before Power Management is applied. Any increase will affect the printer's energy efficiency. Please consider the environment before making any change.



## Using the Optional Hard Disk Unit

# Using the Optional Hard Disk Unit

## Function Summary

When an optional hard disk unit (from now on, hard disk) is installed, you can save print jobs and then reprint them.

### Extended functions

Print jobs can be viewed and managed as described below.

#### Viewing Print Jobs

When there are multiple print jobs with some in the queue, the following information can be displayed.

- Estimated print start time
- Estimated print time

#### Viewing and Resuming Held Print Jobs

If the source or other settings selected with the printer differ from the settings specified in the print job, an error will occur and printing will be suspended.

When an error occurs, printing cannot be restarted until the printer has been readied by, for example, replacing the paper.

However, the following types of print job can be held temporarily on the hard disk.

Therefore, after printing all the jobs that can be printed with the current paper, you can replace the paper with the media specified in the held print jobs and resume printing, making your work more efficient.

- Print jobs that specify sources that differ from that selected with the printer
- Print jobs that specify paper types that differ from that selected with the printer
- Print jobs that specify output paper sizes (widths) that are larger than that selected with the printer

#### Note:

Held print jobs can be saved if **On** is selected for **Store Held Job** in the control panel **Printer Setup** menu.

The factory default setting is **Off**.

 ["Printer Setup" on page 120](#)

#### Viewing and Printing Stored Jobs

Print jobs can be stored on the hard disk and printed at a later date.

Print jobs selected for printing at a later date can be printed directly on the hard disk without increasing the load on your computer.

Print jobs are saved using the printer driver.

 ["Saving Print Jobs" on page 58](#)

#### Note:

Jobs printed with the following applications are always saved to the hard disk.

- LFP Print Plug-In for Office
- EPSON CopyFactory5
- Epson Color Calibration Utility

## Print Job Management

#### From the Print Job menu of the Control Panel

Detailed procedure  ["Viewing and Printing Saved Print Jobs" on page 59](#)

#### From Remote Manager

When the printer and the computer on which the hard disk is installed are connected over a network, use Remote Manager.

 ["Remote Manager" on page 26](#)

#### From LFP HDD Utility (Windows only)

When the printer and the computer on which the hard disk is installed are connected by USB, you can also perform operations from the HDD utility. You can download the software from the Epson home page.

 ["Software on the Website" on page 25](#)

## Using the Optional Hard Disk Unit

### Data on a Hard Disk

Data on a hard disk cannot be copied to a computer or other device. Even when print jobs have been stored on the hard disk, save the original data on a computer.

Data on a hard disk may be lost or corrupted in the following situations.

- When the disk is affected by static electricity or electrical noise
- When the disk has been used incorrectly
- After a malfunction or repair
- When the disk was damaged by a natural disaster

We take no responsibility for any data loss, data corruption, or other problems due to any cause, even including those listed above and within the warranty period. Be aware that we are also not responsible for the recovery of lost or corrupted data.

### Saving Print Jobs

This section describes the printer driver settings used to save print jobs.

#### Settings on Windows

- 1** When you have created the data, click **Print** in the **File** menu.

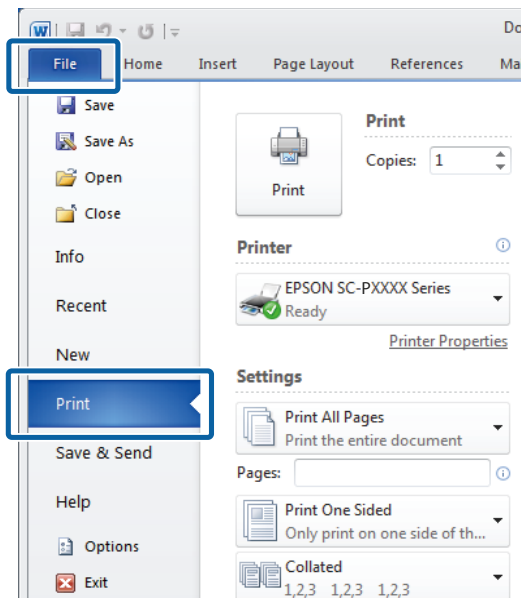

- 2** After confirming that the printer is selected, click **Printer properties** or **Properties** to display printer settings.

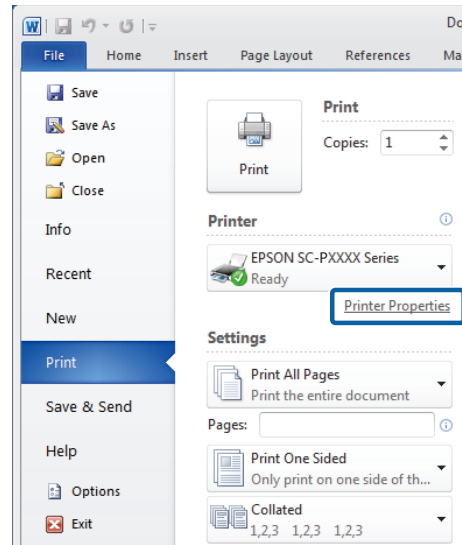

- 3** On the Page Layout screen, click the **Settings** button from Hard Disk Unit, and then select **Print Job**.

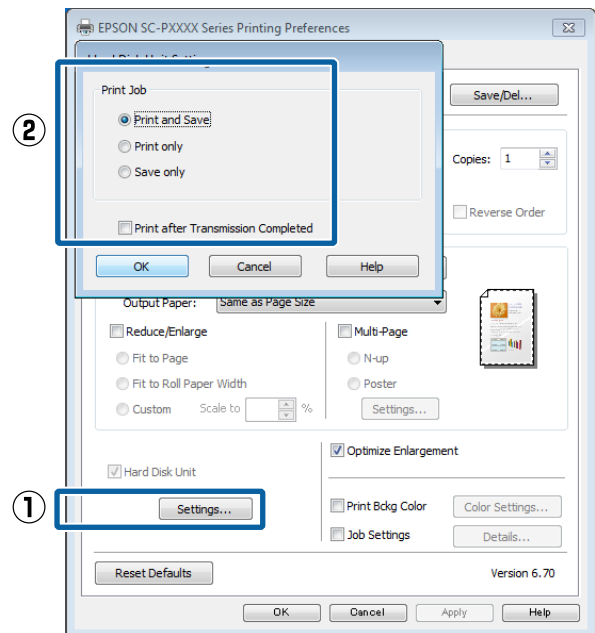

Print operations differ depending on the selected content as shown below.

- Print and Save:**  
Saves the job to the hard disk at the same time as printing. When **Print after Transmission Completed** is selected, printing starts after the print job has been saved to the hard disk unit.
- Print only:**  
Prints the job without saving to the hard disk.

## Using the Optional Hard Disk Unit

- Save only:**  
Saves the job without printing.

Next, print the document normally.

### Making Settings for Mac OS X

- When you have created the data, from the File menu of the application, click **Print** and so on.

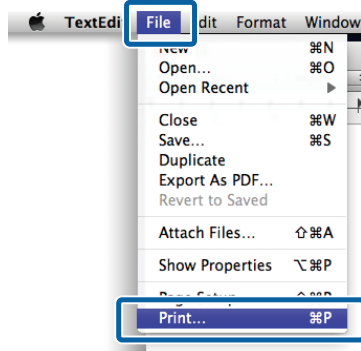

- Check that the printer is selected, and then select **HDD Settings** from the list.

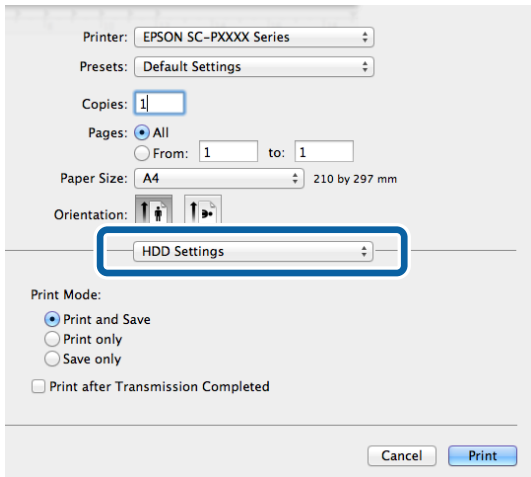

- Select **Print Mode**.

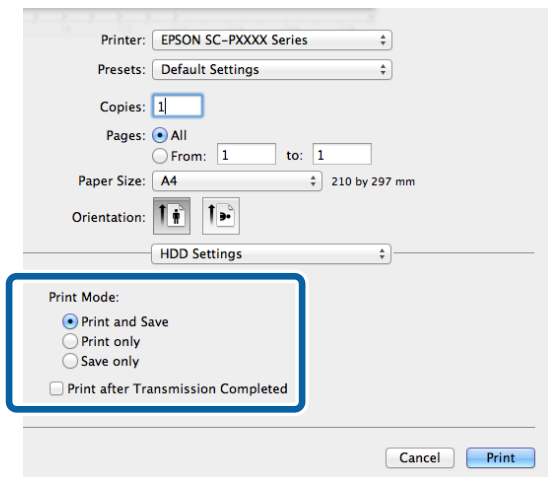

After clicking **Print**, the operations differ depending on the selected content as shown below.

- Print and Save:**  
Saves the job to the hard disk at the same time as printing. When **Print after Transmission Completed** is selected, printing starts after the print job has been saved to the hard disk.
- Print only:**  
Prints the job without saving to the hard disk.
- Save only:**  
Saves the job without printing.

Next, print the document normally.

## Viewing and Printing Saved Print Jobs

This section describes how to view and print saved jobs from the control panel.

Buttons that are used in the following settings

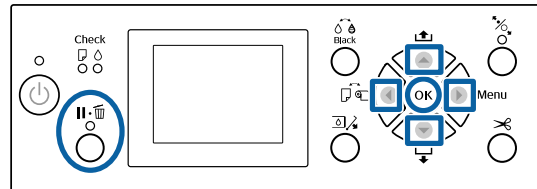

- Confirm that the printer is ready and press the **▶** button.  
The settings menu will be displayed.
- Press the **▼** button, and then the **▶** button.  
The Print Job menu will be displayed.
- Press the **▼/▲** buttons to select **Saved Job Queue** and press the **OK** button.  
The names of stored print jobs are displayed.
- Press the **▼/▲** buttons to select the desired job and press the **OK** button.  
Information on the selected job will be displayed.

## Using the Optional Hard Disk Unit

To exit without printing the job, press the **II** button after viewing job data.

To print the job, proceed to Step 5.

**5**

Press the OK button.

The File Options is displayed.

**6**

Press the **▼/▲** buttons to select **Print File** or **Delete**, and then press the **▶** button.

When **Delete** is selected, a confirmation screen appears. Press the OK button to delete the job.

When **Print File** is selected, proceed to Step 7.

**7**

Press the **▼/▲** buttons, enter the number of copies, and then press the OK button.

Printing starts.

Using the Printer Driver(Windows)

# Using the Printer Driver (Windows)

## Displaying the Settings Screen

You can access the printer driver in the following ways:

- From Windows applications  
☞ “Printing (Windows)” on page 48
- With the Start button

### With the Start button

Follow the steps below when specifying common settings among applications or performing printer maintenance, such as Nozzle Check or Head Cleaning.

**1** On the **Control Panel** click **Hardware and Sound** and then **View devices and printers**.

**For Windows 7**  
 Click **Start** and then **Devices and Printers**.

**For Windows Vista**  
 Click , **Control Panel**, **Hardware and Sound**, and then **Printer**.

**For Windows XP**  
 Click **Start**, **Control Panel**, **Printers and Other Hardware**, and then **Printers and Faxes**.

**Note:**  
 If your Windows XP Control Panel is in **Classic View**, click **Start**, **Control Panel**, and then **Printers and Faxes**.

**2** Right-click your printer icon, and click **Printing preferences**.

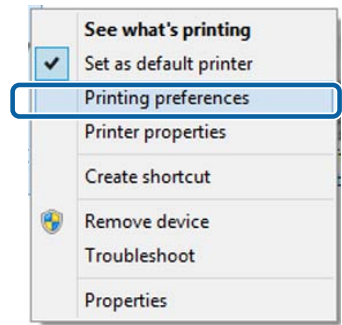

The printer driver setting screen is displayed.

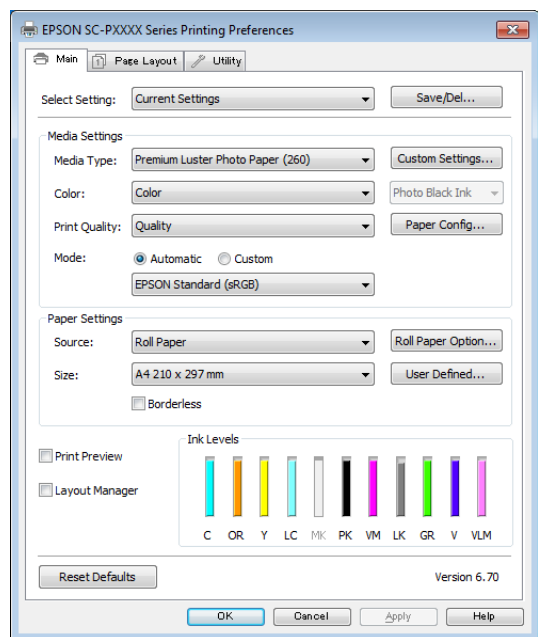

Make the necessary settings. These settings become the default settings of the printer driver.

## Using the Printer Driver(Windows)

# Displaying Help

You can access the printer driver help in the following ways:

- ❑ Click **Help**
- ❑ Right-click on the item you want to check and display

## Click the Help Button to Display

By displaying help, you can use the contents page or keyword search to read the help.

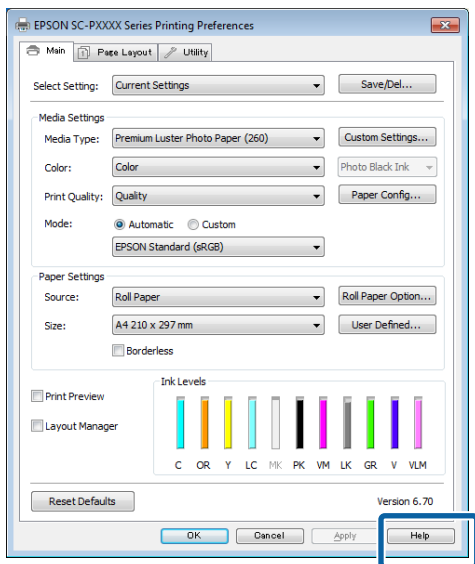

## Right-click on the item you want to check and display

Right-click the item, and then click **Help**.

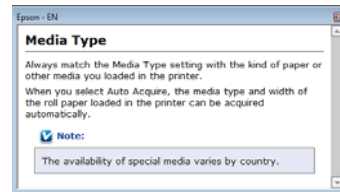
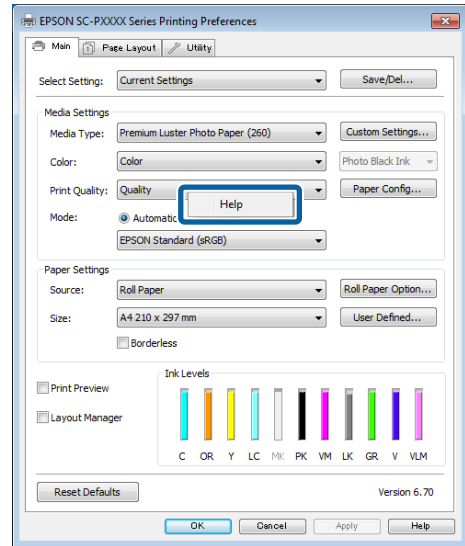

**Note:**  
In Windows XP, click  on the title bar, and then click the help item you want to view.

## Using the Printer Driver(Windows)

# Customizing the Printer Driver

You can save the settings or change the display items as you prefer.

## Saving various settings as your Select Settings

You can save all printer driver settings as a Select Setting. Additionally, in Select Setting the recommended settings for a variety of uses are already available.

This allows you to easily load settings that have been stored in Select Settings, and repeatedly print using exactly the same settings.

**1** Set each item for the **Main** screen and the **Page Layout** screen that you want to save as your Select Settings.

**2** Click **Save/Del** in the **Main** or **Page Layout** tab.

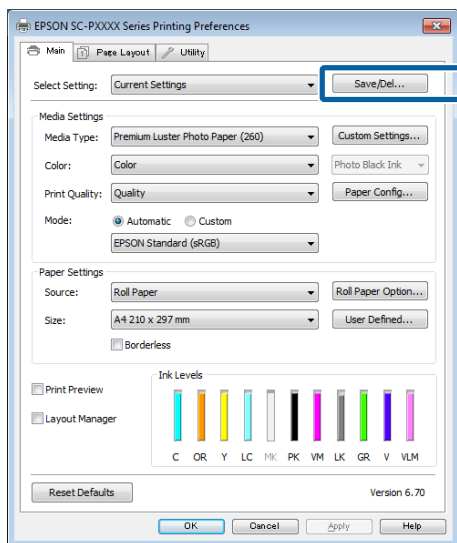

**3** When you enter a name in **Name** and click **Save**, the settings are saved in **Settings List**.

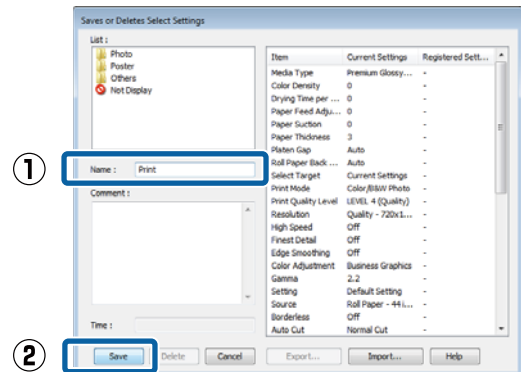

You can load the settings you have saved from **Select Setting** on the Main screen.

### Note:

- You can save up to 100 settings.
- Select the settings you want to save, and then click **Export** to save them to a file. You can share the settings by clicking **Import** to import the saved file on another computer.
- Select the settings you want to delete, and then click **Delete**.

## Adding a Paper Type

This section explains how to register new paper information (Paper Configuration) for Print Quality and Paper Settings (Custom Settings). When settings have been registered, they are displayed in **Media Type** on the printer settings screen and can be selected.

### Important:

When using commercially available paper in Epson Color Calibration Utility, make sure you register the paper information.

**1** Display the printer driver's Main screen.

["Printing \(Windows\)" on page 48](#)

## Using the Printer Driver(Windows)

### 2 Select Media Type, and then click Paper Configuration.

When registering commercially available paper as custom paper, select the Epson special media type that is closest to the paper you are using.

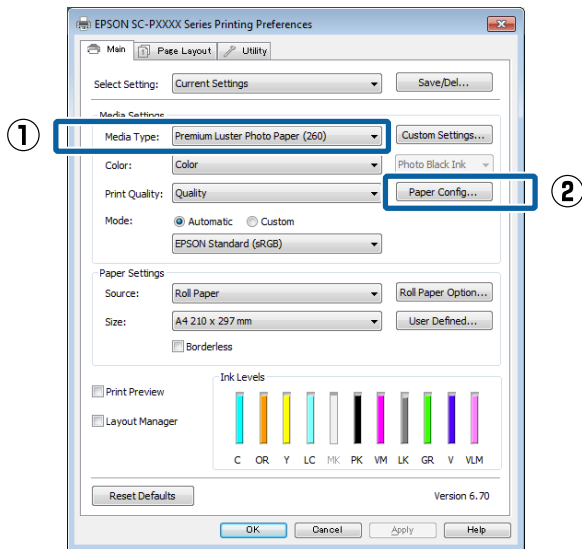

### 3 Adjust settings for the new custom media and click OK.

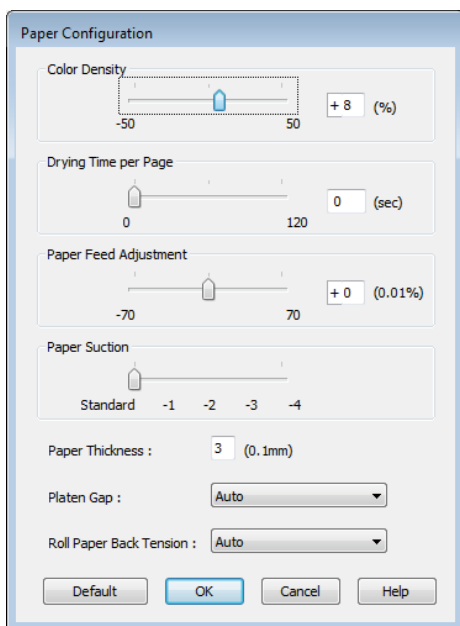

### 4 Click Custom Settings.

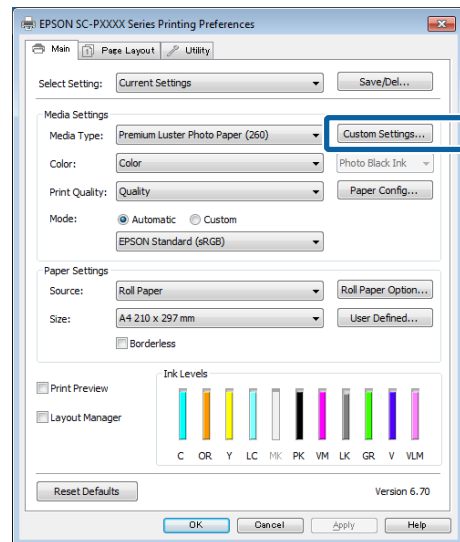

### 5 When you enter a name in Name and click Save, the settings are saved in Settings List.

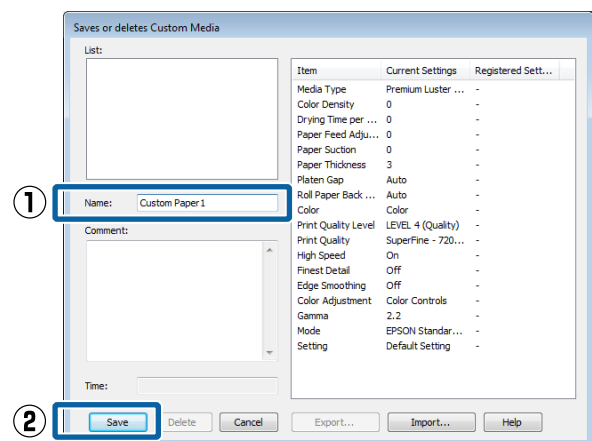

You can select saved settings from **Media Type** on the Main screen.

#### Note:

- ❑ You can save up to 100 settings.
- ❑ Select the settings you want to save, and then click **Export** to save them to a file. You can share the settings by clicking **Import** to import the saved file on another computer.
- ❑ Select the settings you want to delete, and then click **Delete**.



## Using the Printer Driver(Windows)

### Rearranging display items

To display frequently used items right away, you can arrange **Select Setting**, **Media Type**, and **Paper Size** as follows.

- Hide unnecessary items.
- Rearrange in an order of most frequent use.
- Arrange in groups (folders).

#### 1 Go to the **Utility** tab and click **Menu Arrangement**.

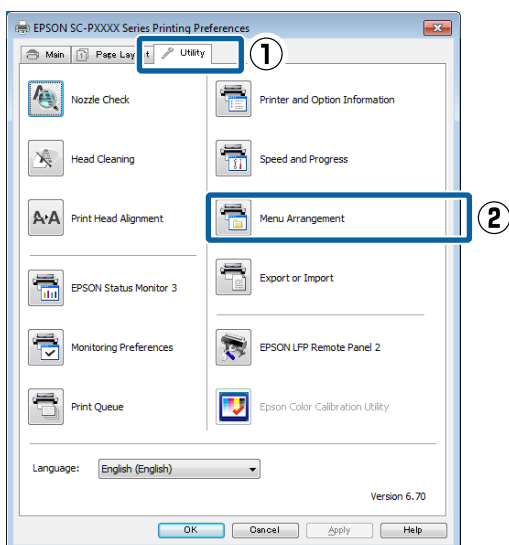

#### 2 Select **Edit Item**.

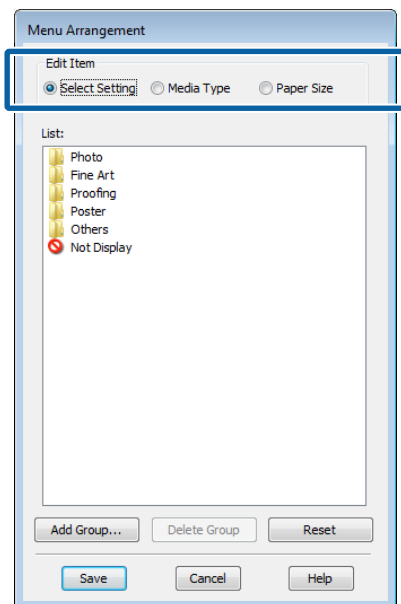

#### 3 Order or group items in the **List** box.

- You can move and order items by dragging and dropping.
- To add a new group (folder), click **Add Group**.
- To delete a group (folder), click **Delete Group**.
- Drag and drop unnecessary items to **Not Display**.

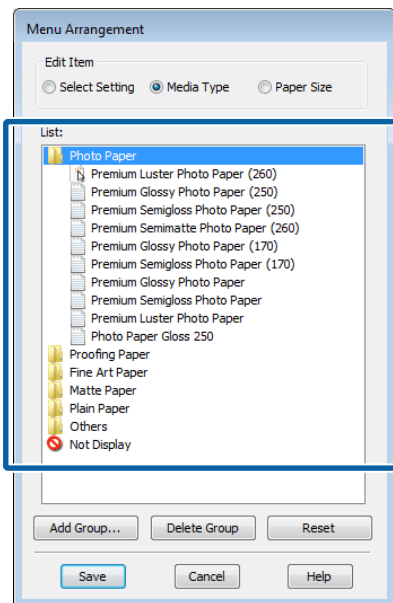

**Note:**

When **Delete Group** is performed, the group (folder) is deleted, however the settings in the deleted group (folder) remain. You also need to delete individually from **Settings List** in the save location.

#### 4 Click **Save**.

## Using the Printer Driver(Windows)

# Summary of the Utility Tab

You can perform the following maintenance functions from the printer driver's **Utility** tab.

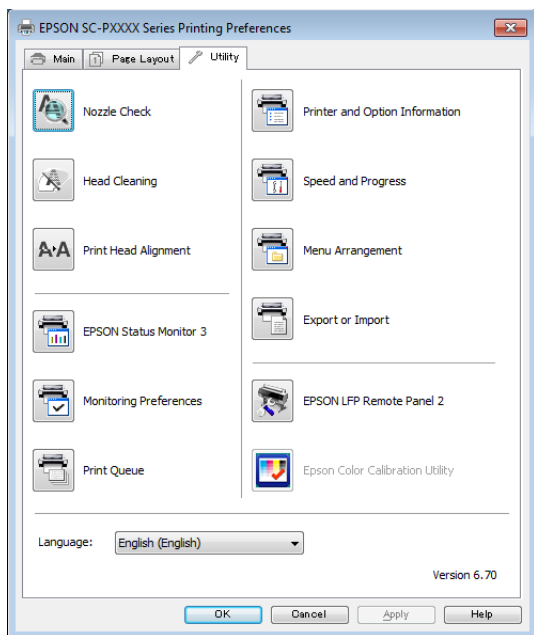

### Nozzle Check

This function prints a nozzle check pattern to check if the print head nozzles are clogged.

If you see banding or gaps in the print outs, perform head cleaning to clear any clogged nozzles.

[“Checking for clogged nozzles” on page 126](#)

### Head Cleaning

If you see banding or gaps in the print outs, perform head cleaning. Cleans the surface of the print head to improve the print quality.

[“Cleaning the print head” on page 127](#)

### Print Head Alignment

If the print results appear grainy or out of focus, perform Print Head Alignment. The Print Head Alignment function corrects print head gaps.

[“Adjusting print misalignments \(Head Alignment\)” on page 126](#)

### EPSON Status Monitor 3

You can check the printer's status, such as the remaining ink level and error messages, on the computer's screen.

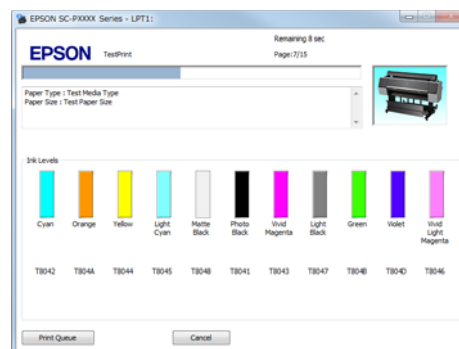

### Monitoring Preferences

You can select the error notifications displayed on the EPSON Status Monitor 3 screen, or register a shortcut for the Utility icon to the Taskbar.

#### Note:

*If you select the **Shortcut Icon** on the **Monitoring Preferences** screen, the Utility shortcut icon is displayed on the Windows Taskbar.*

*By right-clicking the icon, you can display the following menu and perform maintenance functions.*

*EPSON Status Monitor 3 starts when the printer name is clicked from the displayed menu.*

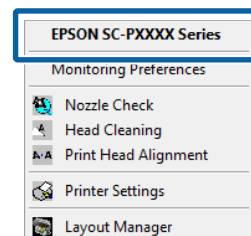

### Print Queue

You can display the list of all waiting jobs.

On the Print Queue screen, you can view information on the data waiting to be printed, delete and reprint these jobs.

### Printer and Option Information (SC-P9000 Series/SC-P7000 Series only)

Displays the inkset information. These settings should not normally be changed.

If you cannot acquire inkset information automatically, select an inkset according to the ink type that is installed in the printer.

## Using the Printer Driver(Windows)

### Speed and Progress

You can set various functions for printer driver basic operations.

### Menu Arrangement

You can arrange the display items of **Select Setting**, **Media Type**, and **Paper Size**. For example, you can reorder them by frequency of access.

 [“Rearranging display items” on page 65](#)

### Export or Import

You can export or import the printer driver settings. This function is useful when you want to make the same printer driver settings on multiple computers.

### EPSON LFP Remote Panel 2

You can configure custom paper settings and other settings. For details, see the EPSON LFP Remote Panel 2 help.

### Epson Color Calibration Utility

Start Epson Color Calibration Utility and perform calibration. See the Epson Color Calibration Utility manual for details.

**Note:**

*If EPSON LFP Remote Panel 2 and Epson Color Calibration Utility are grayed out, the applications are not installed on the computer being used.*

*You can download the latest applications from the Epson website.*

 [“Software on the Website” on page 25](#)

## Using the Printer Driver(Mac OS X)

# Using the Printer Driver (Mac OS X)

## Displaying the Settings Screen

The display method of the printer driver setting screen may differ depending on the application or the OS version.

"Printing (Mac OS X)" on page 49

## Displaying Help

Click in the printer driver setting screen to display Help.

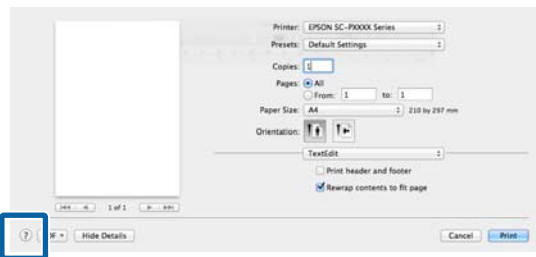

## Using Presets

You can enter a name in **Presets** and save the settings for frequently used setting information (items in Paper Size or Print Settings), and setting information for commercially available paper.

This allows you to easily load settings and repeatedly print using exactly the same settings.

**Note:**

Settings saved in **Presets** can also be selected from Epson Color Calibration Utility. When using commercially available paper in Epson Color Calibration Utility, we recommend saving settings in **Presets**.

## Saving to Presets

**1** Set each item in Paper Size and Print Settings that you want to save to the preset.

**When registering commercially available paper as custom paper**

- (1) Select **Print Settings** from the list, and then select the Epson special media type that is closest to the paper you are using from **Media Type**.
- (2) Select **Paper Configuration** from the list, and then make settings according to the paper you want to register. See the printer driver help for more details on each setting item.

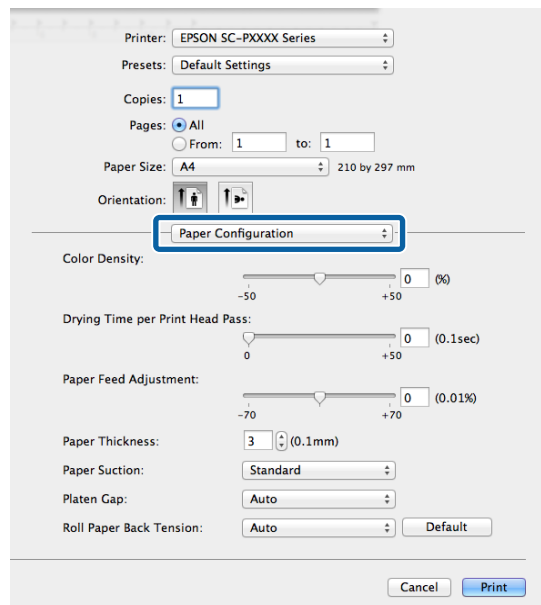

**2** Click **Save Current Settings as Preset...** from **Presets**.

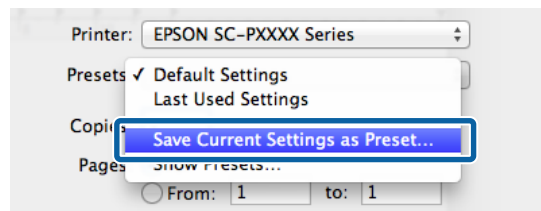

**3** Enter a name, and then click **OK**.

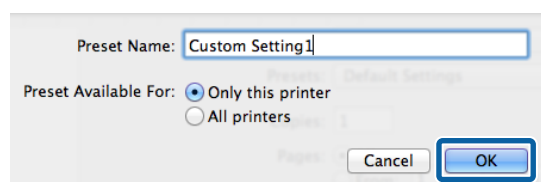

## Using the Printer Driver(Mac OS X)

**Note:**

When **All printers** is selected from **Preset Available For**, you can select the saved **Preset** from all printer drivers installed on your computer.

The settings are saved to **Presets**.

You can then select the settings you saved from **Presets**.

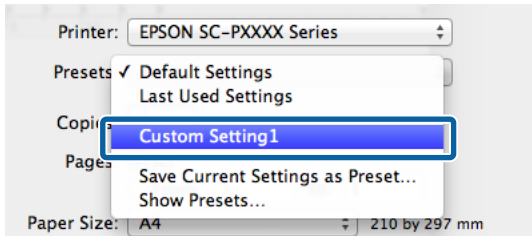

## Deleting from Presets

- 1 On the Print screen, select **Show Presets...** from **Presets**.

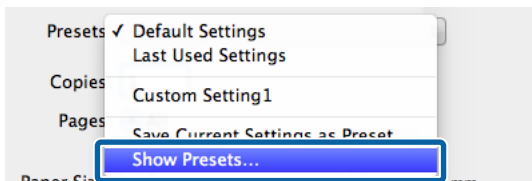

- 2 Select the setting you want to delete, click **Delete**, and then click **OK**.

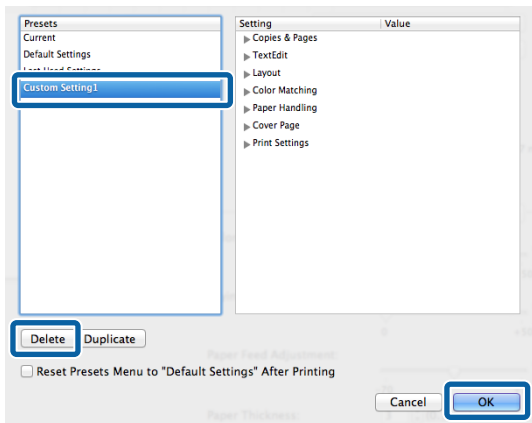

## Using Epson Printer Utility 4

You can perform maintenance tasks such as Nozzle Check or Head Cleaning by using Epson Printer Utility 4. This utility is installed automatically when you install the printer driver.

## Starting Epson Printer Utility 4

- 1 Click the Apple menu - **System Preferences** - **Printers & Scanners** (or **Print & Fax**).
- 2 Select the printer and click **Options & Supplies** > **Utility** > **Open Printer Utility**.

## Epson Printer Utility 4 Functions

You can perform the following maintenance functions from Epson Printer Utility 4.



## Using the Printer Driver(Mac OS X)

### EPSON Status Monitor

You can check the printer's status, such as the remaining ink level and error messages, on the computer's screen.

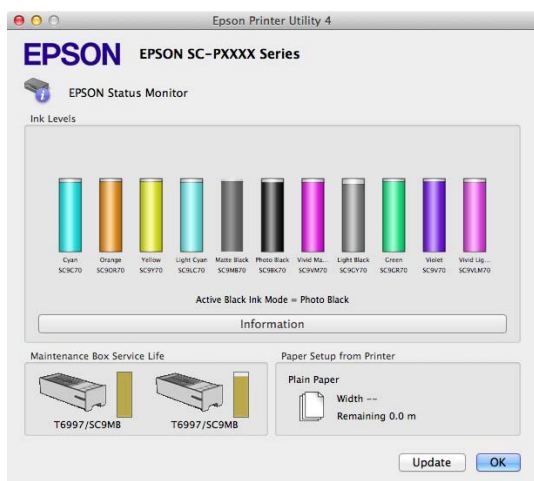

### Nozzle Check

This function prints a nozzle check pattern to check if the print head nozzles are clogged.

If you see banding or gaps in the print outs, perform head cleaning to clear any clogged nozzles.

[“Checking for clogged nozzles” on page 126](#)

### Head Cleaning

If you see banding or gaps in the print outs, perform head cleaning. Cleans the surface of the print head to improve the print quality.

[“Cleaning the print head” on page 127](#)

### Print Head Alignment

Perform print head alignment if the print results appear grainy or blurred. The Print Head Alignment function corrects print head gaps.

[“Adjusting print misalignments \(Head Alignment\)” on page 126](#)

### EPSON LFP Remote Panel 2

You can configure custom paper settings and other settings. For details, see the EPSON LFP Remote Panel 2 help.

#### **Note:**

If EPSON LFP Remote Panel 2 is grayed out, the application is not installed on the computer being used.

You can download the latest applications from the Epson website.

[“Software on the Website” on page 25](#)

Printing Varieties

# Printing Varieties

## Auto Color Adjustment by PhotoEnhance (Windows Only)

The printer driver for this printer comes with the Epson proprietary function PhotoEnhance that makes the most efficient use of the color reproduction area, corrects image data to improve colors before printing.

By using PhotoEnhance, you can correct photo colors to match the subject types such as people, scenery, or night view. You can print color data in sepia or black and white. Colors are automatically corrected simply by selecting the print mode.

**Note:**  
It is recommended that you use images with a color space of sRGB.

**1** When using applications featuring a color management function, specify how to adjust colors from these applications.

When using applications without a color management function, start from step 2.

Depending on the type of the application, make the settings following the table below.

- Adobe Photoshop CS3 or later
- Adobe Photoshop Elements 6.0 or later
- Adobe Photoshop Lightroom 1 or later

OS	Color Management Settings
Windows 8.1, Windows 8, Windows 7, Windows Vista	Printer Manages Colors
Windows XP (Service Pack 2 or later and .NET 3.0 or later)	
Windows XP (other than the above)	No Color Management

In other applications, set **No Color Management**.

**Note:**  
For information on supported platforms, see the website for the application in question.

Setting example for Adobe Photoshop CS5

Open the **Print** screen.

Select **Color Management** and then **Document**. Select **Printer Manages Colors** as the **Color Handling** setting, and then click **Print**.

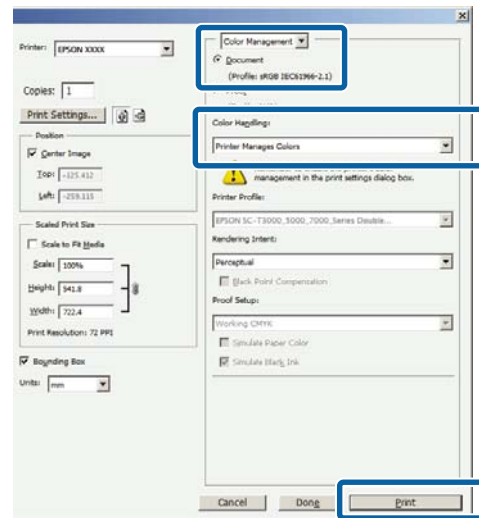

**2** Display the printer driver's **Main** screen.

[“Printing \(Windows\)” on page 48](#)

## Printing Varieties

- 3 Select **Custom Settings** from **Color Mode**, and then select **PhotoEnhance**.

To make more detailed adjustments, click **Advanced**, and then proceed to Step 4.

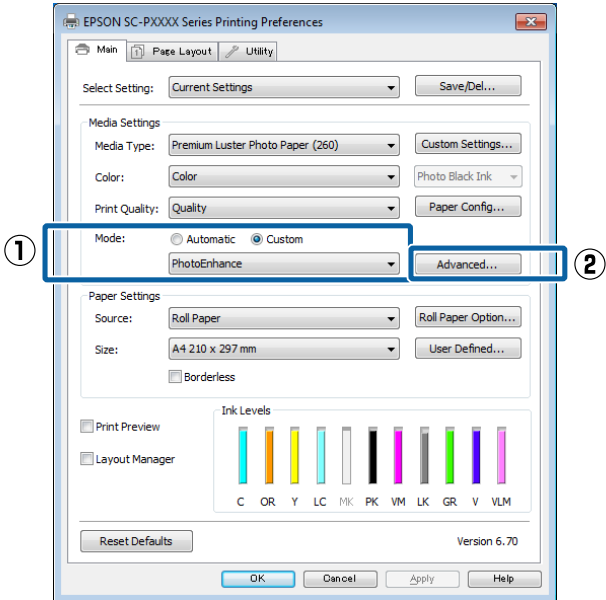

- 4 On the **PhotoEnhance** screen, you can set effects to apply to the print data.

See the printer driver help for more details on each item.

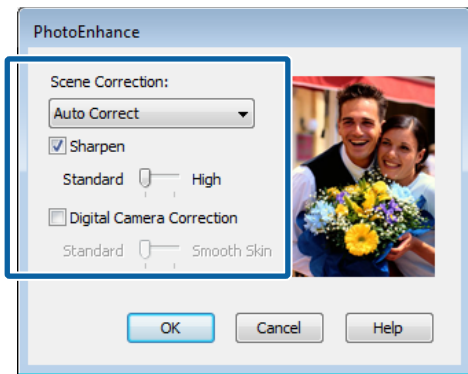

- 5 Check other settings, and then start printing.

## Correct color and print

The printer driver automatically and internally corrects colors to match the color space. You can select from the following color correction modes.

- EPSON Standard (sRGB)  
Optimizes the sRGB space and corrects the color.
- Adobe RGB  
Adobe RGB Optimizes the sRGB space and corrects the color.

Note that if you click **Advanced** when one of the above color processing options is selected, you can fine-tune Gamma, Brightness, Contrast, Saturation, and color balance for the selected option.

Use this option when the application in use does not have a color correction function.

### Making Settings in Windows

- 1 When using applications featuring a color management function, specify how to adjust colors from these applications.

When using applications without a color management function, start from step 2.

Depending on the type of the application, make the settings following the table below.

Adobe Photoshop CS3 or later  
 Adobe Photoshop Elements 6.0 or later  
 Adobe Photoshop Lightroom 1 or later

OS	Color Management Settings
Windows 8.1, Windows 8, Windows 7, Windows Vista	Printer Manages Colors
Windows XP (Service Pack 2 or later and .NET 3.0 or later)	Printer Manages Colors
Windows XP (other than the above)	No Color Management

In other applications, set **No Color Management**.



## Printing Varieties

**Note:**

For information on supported platforms, see the website for the application in question.

Setting example for Adobe Photoshop CS5

Open the **Print** screen.

Select **Color Management** and then **Document**.  
 Select **Printer Manages Colors** as the **Color Handling** setting, and then click **Print**.

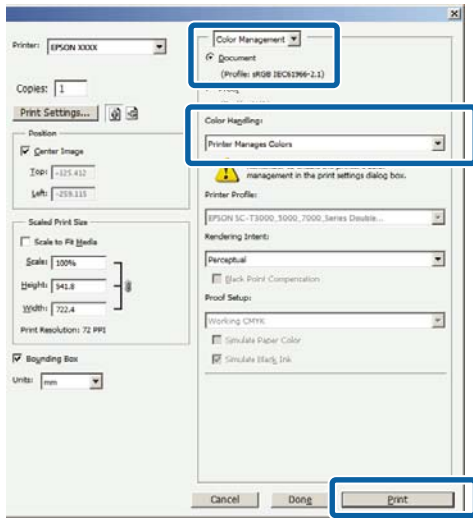

**2** Display the printer driver's **Main** screen.

☞ **“Printing (Windows)”** on page 48

**3** Select **Custom Settings** from **Color Mode**, and then select **Color Controls**.

To make more detailed adjustments, click **Advanced**, and then proceed to Step 4.

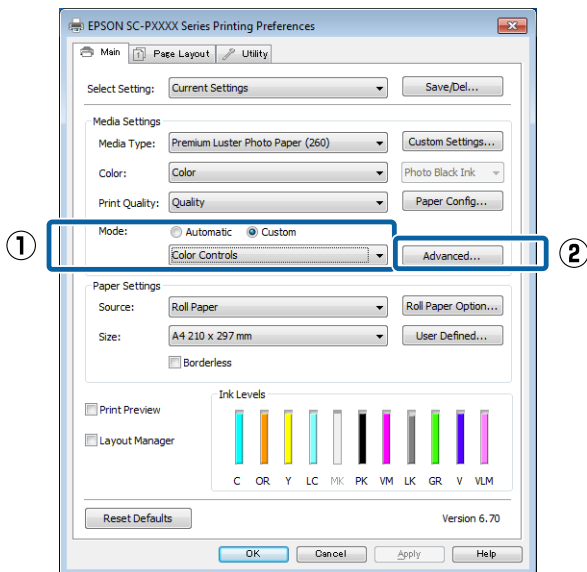

**4** Make the necessary settings.

See the printer driver help for more details on each item.

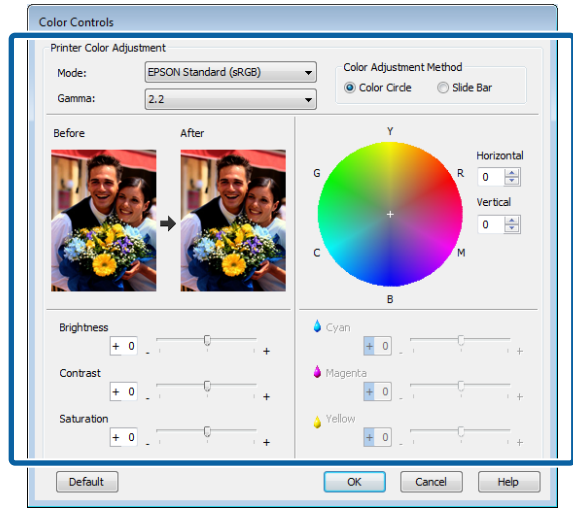

**Note:**

You can adjust the correction value by checking the sample image on the left side of the screen. You can also use the color circle to fine-tune the color balance.

**5** Check other settings, and then start printing.

### Making Settings for Mac OS X

**1** When using applications featuring a color management function, specify how to adjust colors from these applications.

When using applications without a color management function, start from step 2.

When using the following applications, select the **Printer Manages Colors** color management option.

- Adobe Photoshop CS3 or later
- Adobe Photoshop Elements 6 or later
- Adobe Photoshop Lightroom 1 or later

In other applications, set **No Color Management**.

**Note:**

For information on supported platforms, see the website for the application in question.

Setting example for Adobe Photoshop CS5

Open the **Print** screen.

## Printing Varieties

Select **Color Management** and then **Document**. Select **Printer Manages Colors** as the **Color Handling** setting, and then click **Print**.

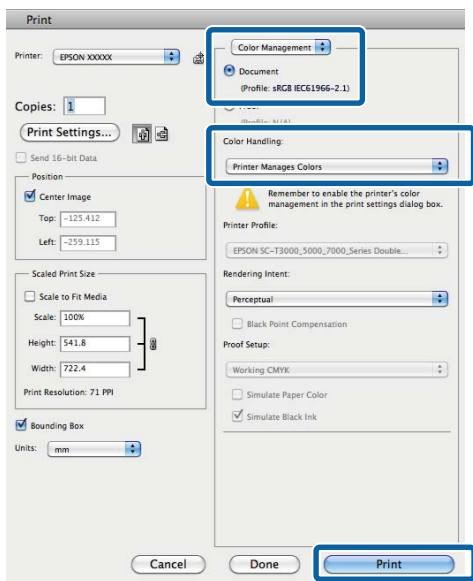

**2** Display the Print screen.

["Printing \(Mac OS X\)" on page 49](#)

**3** Select **Color Matching** from the list, and then click **EPSON Color Controls**.

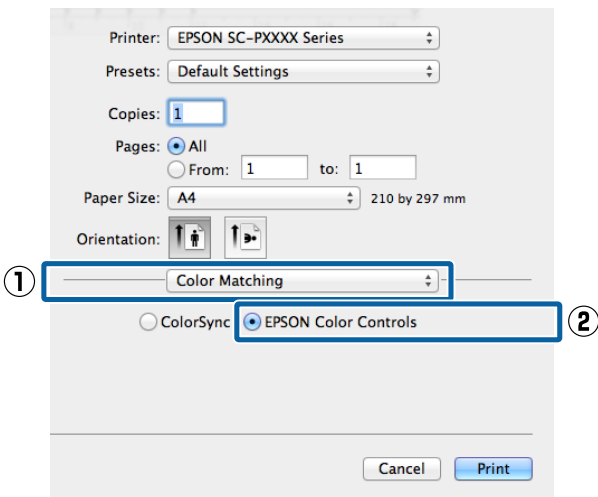

**Note:**

*EPSON Color Controls will not be available in the following applications if Step 1 is omitted.*

- Adobe Photoshop CS3 or later
- Adobe Photoshop Lightroom 1 or later
- Adobe Photoshop Elements 6 or later

**4** Select **Print Settings** from the list, and then select **Color Controls** as the **Color Settings** setting. When adjusting the parameters manually, click **Advanced Color Settings**.

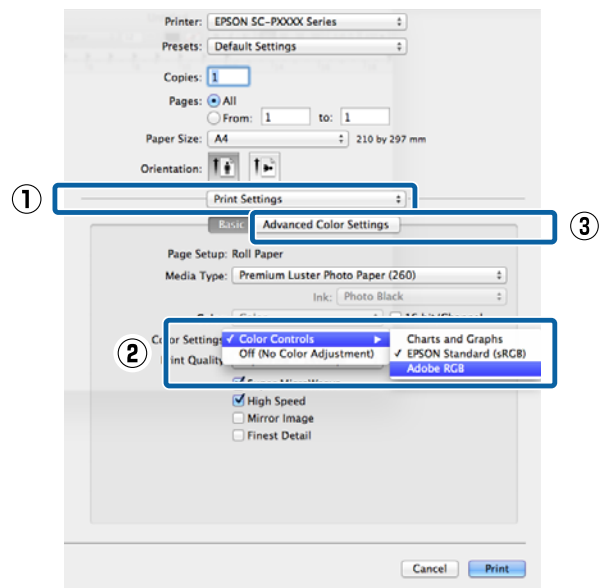

**5** Make the necessary settings.

See the printer driver help for more details on each item.

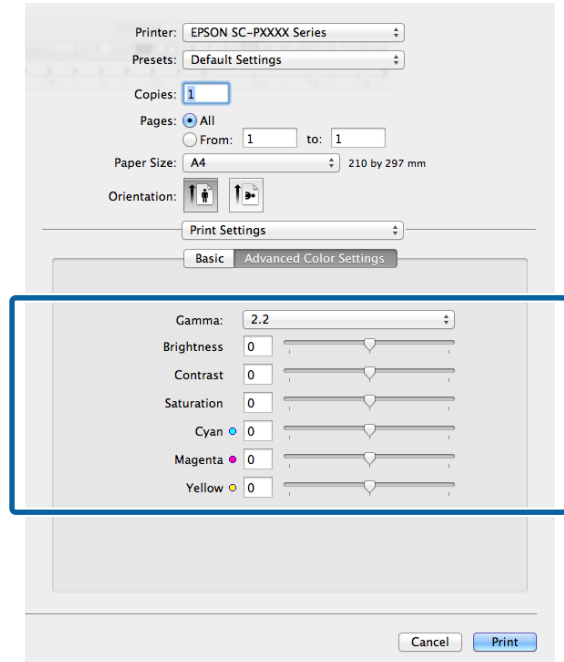

**6** Check other settings, and then start printing.

Printing Varieties

# Printing Black and White Photos

You can print black and white photos with rich gradation by adjusting the image data color by the printer driver. You can correct image data when printing without processing the data from applications. The original data is not affected.

You cannot select **Advanced B&W Photo** in the following instances. When printing in black and white, select **Black** (Windows) or **Grayscale** (Mac OS X).

- ❑ When using the Violet inkset for the SC-P9000 Series/SC-P7000 Series
- ❑ When using Singleweight Matte Paper, Photo Quality Ink Jet Paper, or Plain Paper

**Note:**  
It is recommended that you use images with a color space of sRGB.

## Making Settings in Windows

**1** When using applications featuring a color management function, specify how to adjust colors from these applications.

When using applications without a color management function, start from step 2.

Depending on the type of the application, make the settings following the table below.

Adobe Photoshop CS3 or later  
 Adobe Photoshop Elements 6.0 or later  
 Adobe Photoshop Lightroom 1 or later

OS	Color Management Settings
Windows 8.1, Windows 8, Windows 7, Windows Vista	Printer Manages Colors
Windows XP (Service Pack 2 or later and .NET 3.0 or later)	Printer Manages Colors
Windows XP (other than the above)	No Color Management

In other applications, set **No Color Management**.

**Note:**  
For information on supported platforms, see the website for the application in question.

Setting example for Adobe Photoshop CS5

Open the **Print** screen.

Select **Color Management** and then **Document**. Select **Printer Manages Colors** or **No Color Management** as the **Color Handling** setting, and then click **Print**.

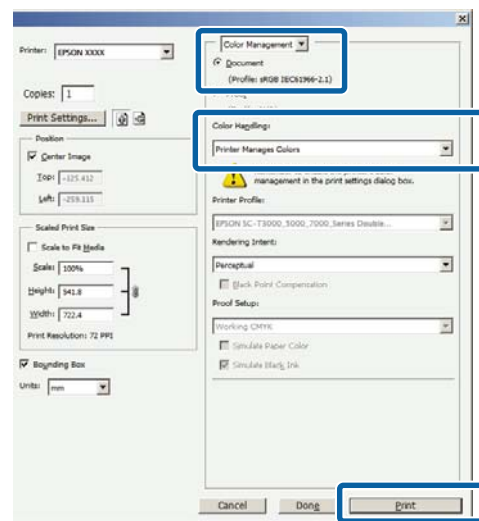

**2** Display the printer driver's **Main** screen.

["Printing \(Windows\)" on page 48](#)

**3** Select **Color** from **Advanced B&W Photo**.

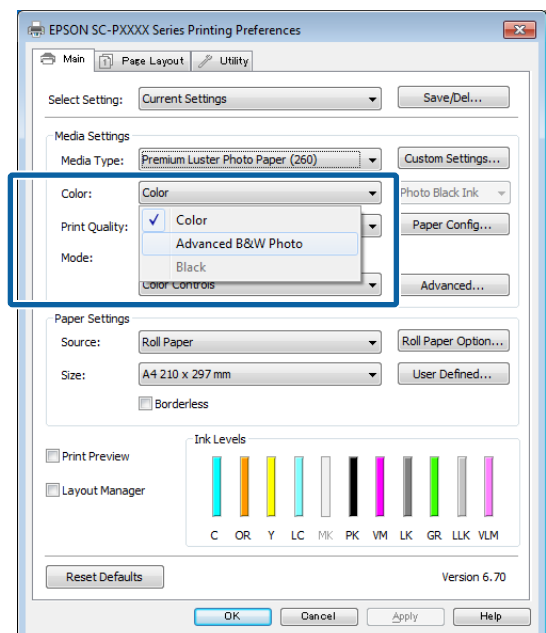

## Printing Varieties

To make detailed adjustments, proceed to Step 4. If you do not want to make adjustments, proceed to Step 6.

- 4** Select **Custom Settings** from **Color Mode**, and then click **Advanced**.

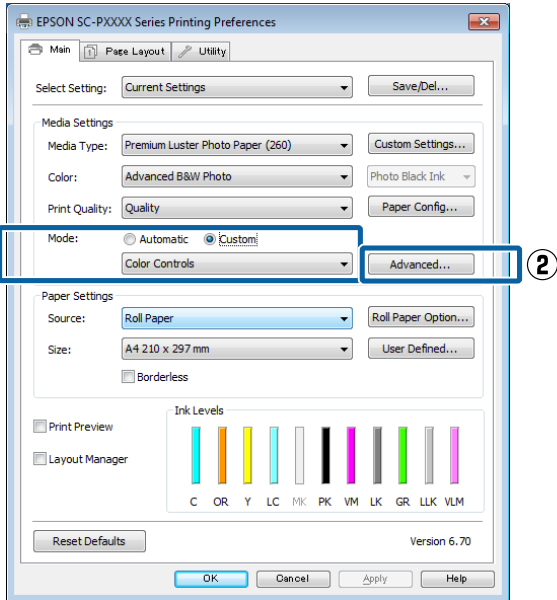

- 5** Make the necessary settings. See the printer driver help for more details on each item.

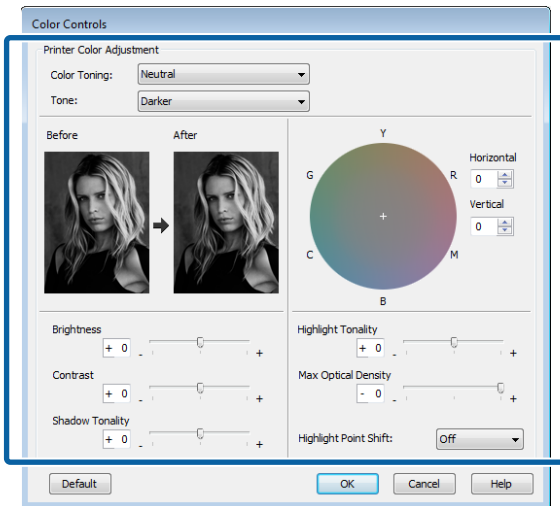

- 6** Check other settings, and then start printing.

### Making Settings for Mac OS X

- 1** When using applications featuring a color management function, specify how to adjust colors from these applications.

When using the following applications, select the **Printer Manages Colors** color management option.

Adobe Photoshop CS3 or later  
 Adobe Photoshop Elements 6 or later  
 Adobe Photoshop Lightroom 1 or later

In other applications, set **No Color Management**.

**Note:**  
 For information on supported platforms, see the website for the application in question.

Setting example for Adobe Photoshop CS5

Open the **Print** screen.

Select **Color Management** and then **Document**. Select **Printer Manages Colors** as the **Color Handling** setting, and then click **Print**.

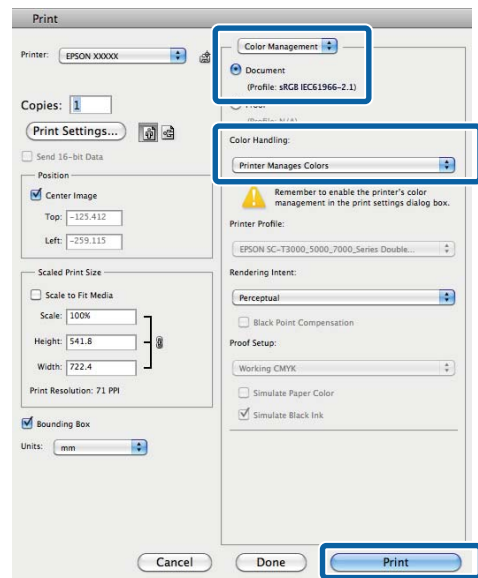

## Printing Varieties

- 2 Display the Print screen, select **Print Settings** from the list, and then select **Advanced B&W Photo** as the **Color**.

"Printing (Mac OS X)" on page 49

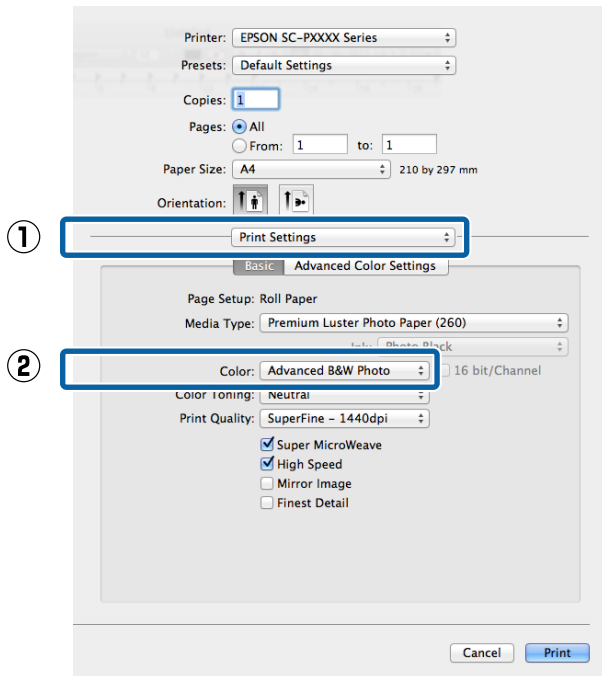

- 3 Click **Advanced Color Settings**.

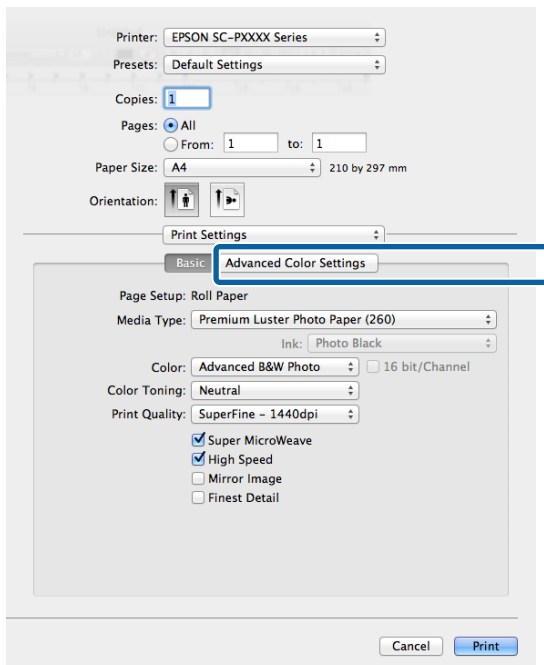

- 4 Make the necessary settings.  
See the printer driver help for more details on each item.

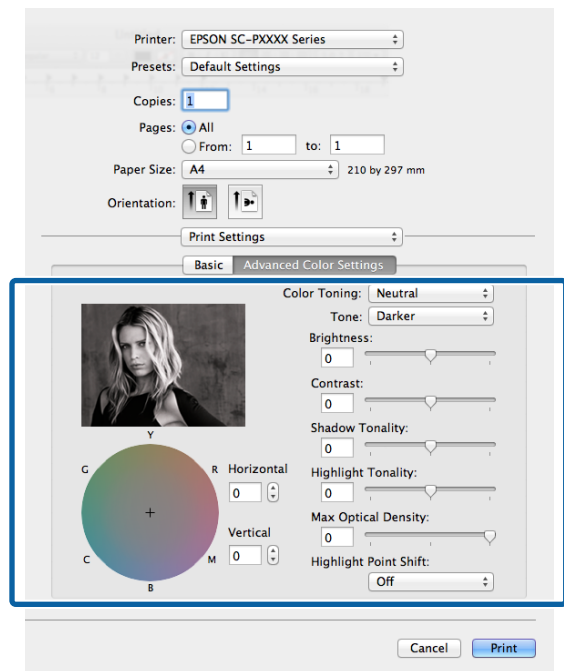

- 5 Check other settings, and then start printing.

## Printing Varieties

### Borderless Printing

You can print your data without margins on the paper.

The types of borderless printing you can choose vary as shown below depending on the media type.

Roll Paper: No margins for all edges, no margins for the left and right

Cut Sheets: No margins for the left and right only

(Borderless printing is not available with poster board.)

When printing borderless for all edges, you can also configure the cutting operation.

[☞ “About Roll Paper Cutting” on page 79](#)

When performing left and right borderless printing, margins appear on the top and bottom of the paper.

Top and bottom margin values [☞ “Printable area” on page 52](#)

---

### Types of Borderless Printing Methods

You can perform borderless printing using the following two methods.

- Auto Expand  
The printer driver enlarges the print data to a size slightly larger than the paper size and prints the enlarged image. The sections which are beyond the paper edges are not printed; therefore, resulting in borderless printing.  
Use settings such as Page Setup in the applications to set the size of the image data as follows.
  - Match the paper size and page setting for the print data.
  - If the application has margin settings, set the margins to 0 mm.
  - Make the image data as large as the paper size.

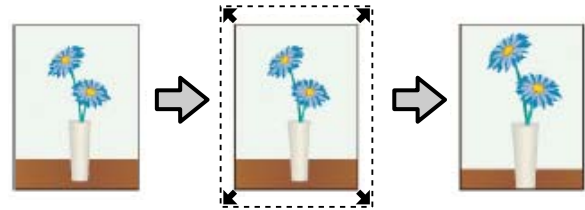

- Retain Size  
Create the print data larger than the paper size in the applications to produce borderless output. The printer driver does not enlarge the image data. Use settings such as Page Setup in the applications to set the size of the image data as follows.
  - Create print data larger than its actual print size by 3 mm on the left and right (6 mm in total).
  - If the application has margin settings, set the margins to 0 mm.
  - Make the image data as large as the paper size.

Select this setting if you want to avoid image enlargement by the printer driver.

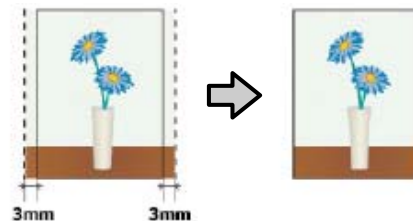

---

### Supported Paper

Depending on the media type or size, the print quality may decline or borderless printing cannot be selected.

[☞ “Epson Special Media Table” on page 159](#)

[☞ “Supported Commercially Available Paper” on page 176](#)

**Printing Varieties**

**About Roll Paper Cutting**

When performing borderless printing on roll paper, you can specify whether it is left and right borderless printing or all edges borderless printing, and how to cut the paper in the printer driver's **Roll Paper Option**. The cutting operation for each value is shown in the following chart.

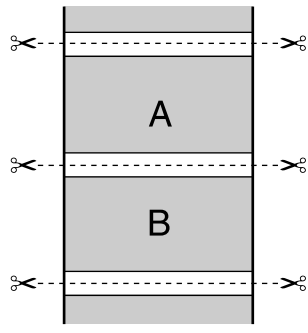
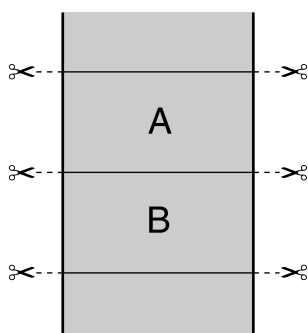
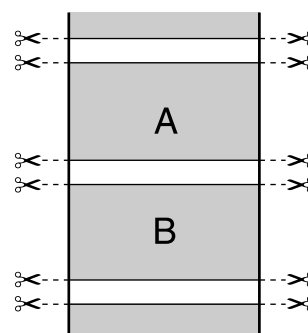
Printer driver settings	Normal Cut	Single Cut	Double Cut
Cutting Operation			
Explanation	<p>The default printer driver setting is <b>Normal Cut</b>.</p>	<ul style="list-style-type: none"> <li>❑ The top area may become slightly uneven depending on the image since the print operation stops while cutting the top edge of the roll paper.</li> <li>❑ If the cut position is misaligned slightly, small parts of the image may be shown on the top or bottom of the adjacent pages. If this occurs, perform <b>Adjust Cut Position</b>.  <a href="#">👉 "Maintenance" on page 114</a></li> <li>❑ When you print one page only or print one page multiple times, the operation is the same as that for <b>Double Cut</b>. When continuously printing multiple sheets, the printer cuts 1 mm inside on the top edge of the first page and the bottom edge of the subsequent pages to avoid showing margins.</li> </ul>	<ul style="list-style-type: none"> <li>❑ The top area may become slightly uneven depending on the image since the print operation stops while cutting the top edge of the roll paper.</li> <li>❑ The printed paper is approximately 2 mm shorter than the specified size since the printer cuts the paper inside the image to avoid showing top and bottom margins.</li> <li>❑ After cutting the bottom edge of the previous page, the printer feeds the paper, and then cuts the top edge of the following page. Although this produces 60 to 127 mm cut-off pieces, the cut is more accurate.</li> </ul>

## Printing Varieties

### Setting Procedures for Printing

#### Making Settings in Windows

**1** When the printer driver's **Main** screen is displayed, you can configure various settings required for printing such as **Media Type**, **Source**, **Size**.

"Printing (Windows)" on page 48

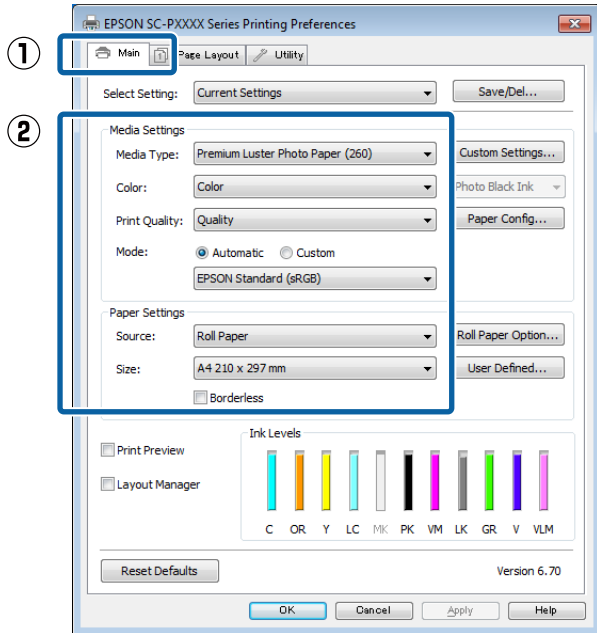

**2** Select **Borderless**, and then click **Expansion**.  
You can not choose the expansion amount when **Roll Paper** or **Roll Paper (Banner)** is selected for **Source**.

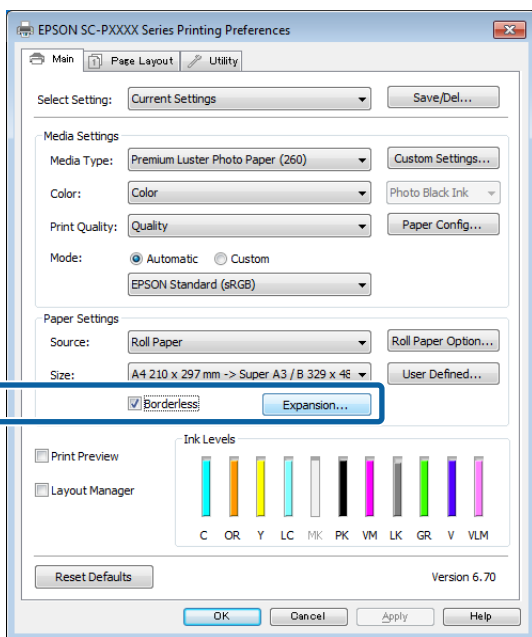

**3** Select **Auto Expand** or **Retain Size** as the **Method of Enlargement**.

If you select **Auto Expand**, set how much of the image goes beyond the edge of the paper as shown below.

Max : 3 mm for left and 5 mm for right (the image shifts 1 mm to the right)

Normal : 3 mm for left and right

Min : 1.5mm for left and right

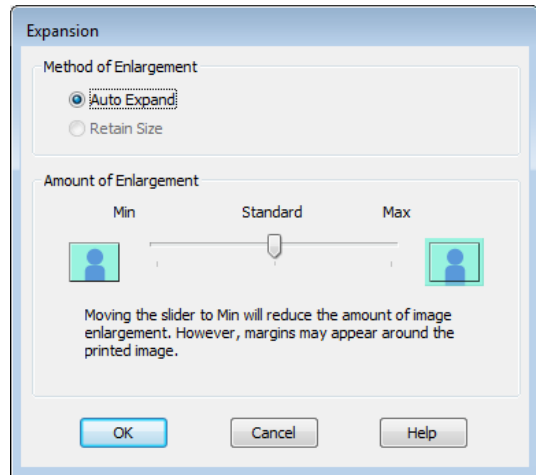

**Note:**  
*Moving the slider towards **Min** decreases the image enlargement ratio. Therefore, some margins may appear at the edges of the paper depending on the paper and printing environment.*



## Printing Varieties

- 4** When using roll paper, click **Roll Paper Option**, and then set **Auto Cut** option.

[“About Roll Paper Cutting” on page 79](#)

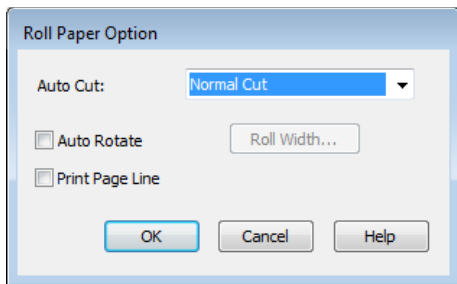
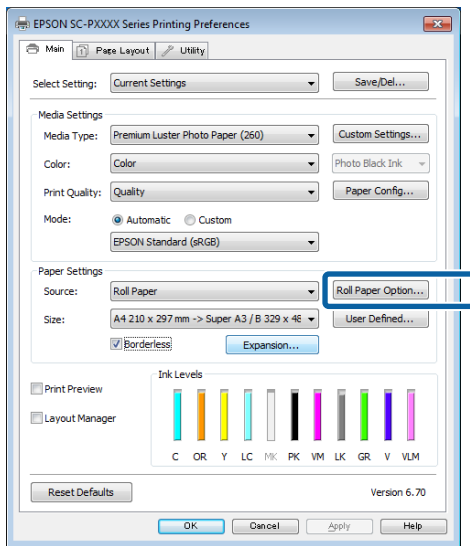

- 5** Check other settings, and then start printing.

### Making Settings for Mac OS X

- 1** Open the Print screen and select the paper size from the **Paper Size** option, and then select a borderless printing method.

[“Printing \(Mac OS X\)” on page 49](#)

The selections for borderless printing methods are displayed as shown below.

- xxxx (Roll Paper - Borderless, Auto Expand)
- xxxx (Roll Paper - Borderless, Retain Size)
- xxxx (Sheet - Borderless, Auto Expand)
- xxxx (Sheet - Borderless, Retain Size)

Where XXXX is the actual paper size, such as A4.

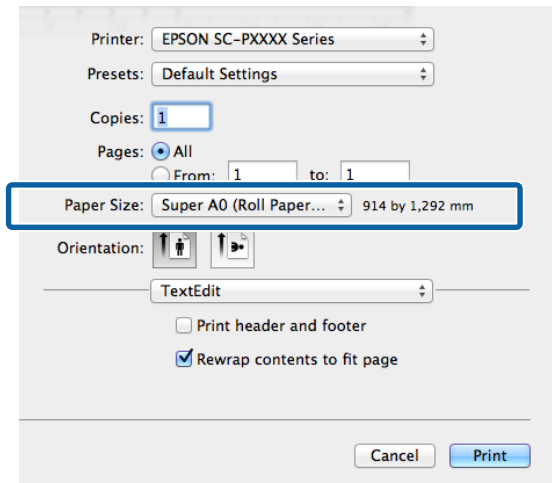

**Note:**

*If page setting options are not available in the application's print dialog, display the page settings dialog.*

- 2** Select **Page Layout Settings** from the list, and then set **Roll Paper Option** or **Expansion**.

See the following for more details on **Auto Cut** from **Roll Paper Option**.

[“About Roll Paper Cutting” on page 79](#)

**Expansion** is only available when **Auto Expand** is selected from **Paper Size**. The following shows the values for each item.

Max : 3 mm for left and 5 mm for right (the image shifts 1 mm to the right)

Normal : 3 mm for left and right

Min : 1.5mm for left and right

## Printing Varieties

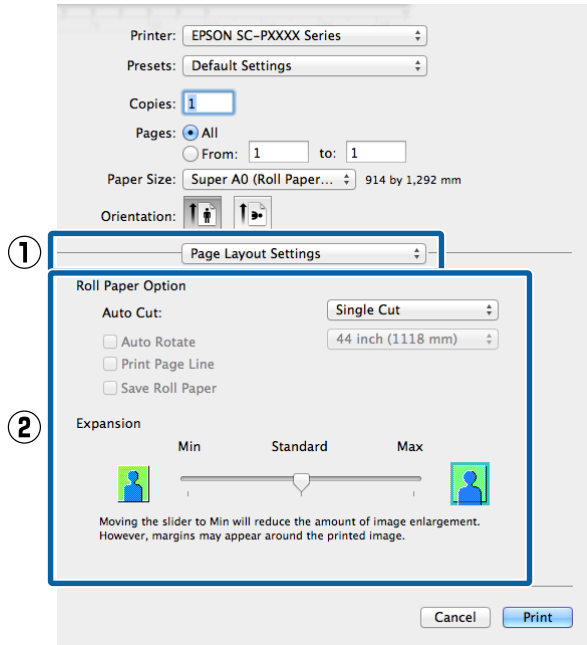

**Note:**

Moving the slider towards **Min** decreases the image enlargement ratio. Therefore, some margins may appear at the edges of the paper depending on the paper and printing environment.

**3** Check other settings, and then start printing.

## Enlarged/Reduced Printing

You can enlarge or reduce the size of your data. There are three setting methods.

- Fit to Page printing**  
Automatically enlarges or reduces the image size to fit the paper size.

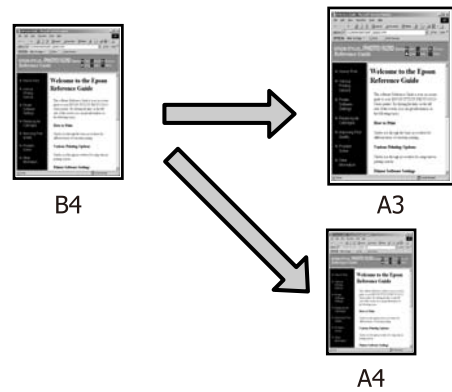

- Fit to Roll Paper Width (Windows only)**  
Automatically enlarges or reduces the image size to fit the roll paper width.

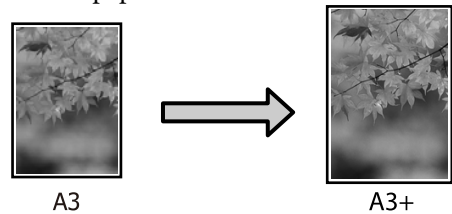

- Custom**  
You can specify the enlargement or reduction ratio. Use this method for a non-standard paper size.

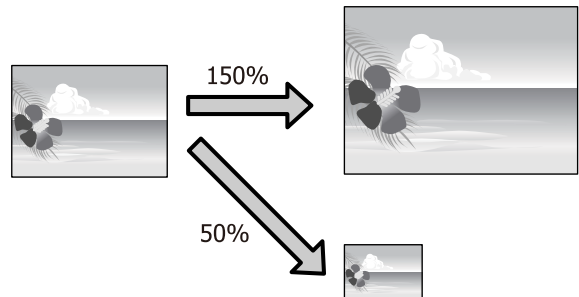

## Printing Varieties

### Fit to Page/Scale to fit paper size

#### Making Settings in Windows

**1** When the printer driver's **Page Layout** screen is displayed, set the same paper size as the data's paper size in **Page Size** or **Paper Size**.

“Printing (Windows)” on page 48

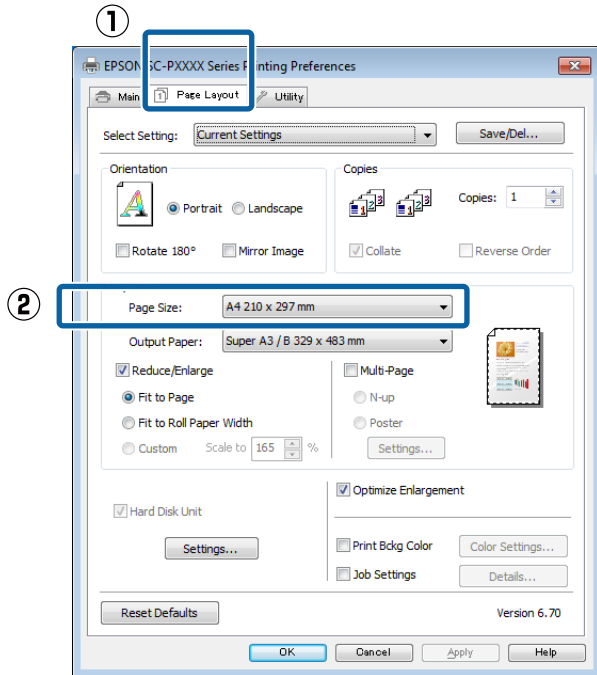

**2** Select the size of the paper loaded in the printer from the **Output Paper** list.

**Fit to Page** is selected as **Reduce/Enlarge**.

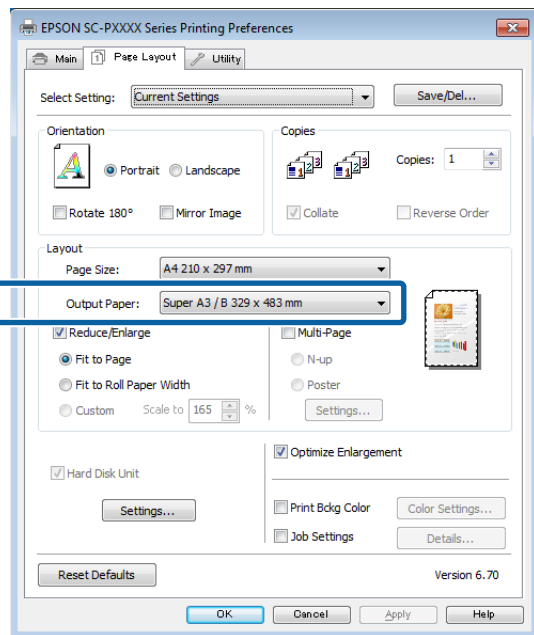

**3** Check other settings, and then start printing.

#### Making Settings for Mac OS X

**1** Open the Print screen, select **Paper Handling** from the list, and then check **Scale to fit paper size**.

“Printing (Mac OS X)” on page 49

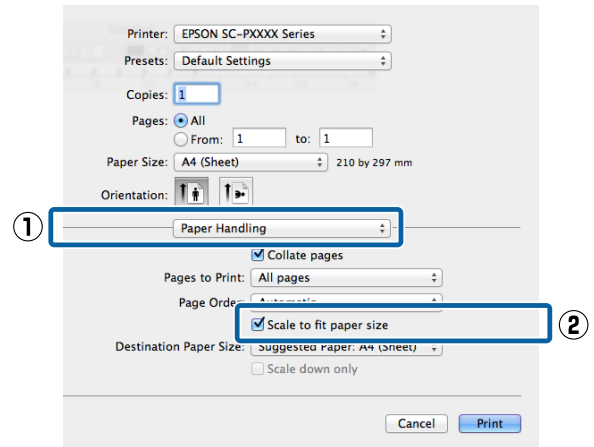

**2** Select the size of the paper loaded in the printer as the **Destination Paper Size**.

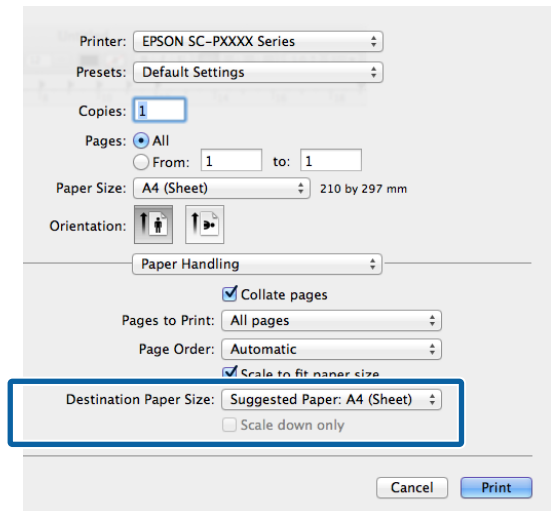

**Note:**

When performing enlarged printing, clear the **Scale down only** check box.

**3** Check other settings, and then start printing.

## Printing Varieties

### Fit to Roll Paper Width (Windows Only)

- 1 Display the printer driver **Main** tab and select **Roll Paper** for **Source**.  
[“Printing \(Windows\)” on page 48](#)
- 2 Display the **Page Layout** tab and choose a **Page Size** that matches the page size used in the document size.

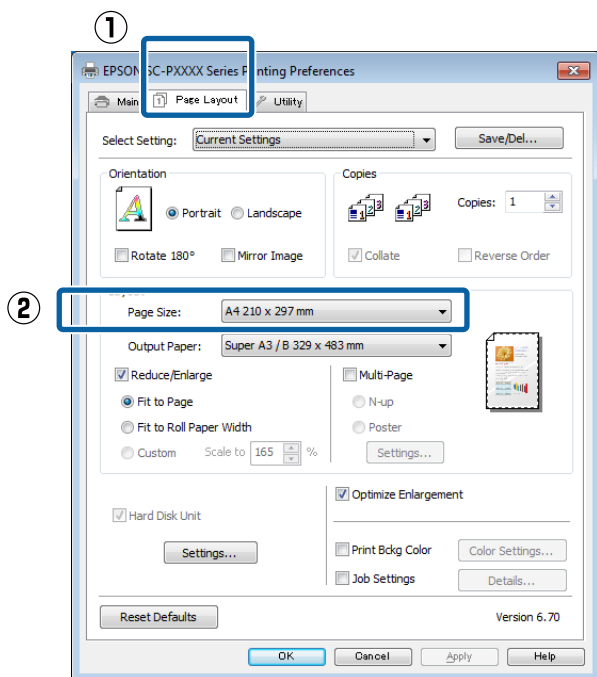

- 3 Select the size of the paper loaded in the printer from the **Output Paper** list.  
**Fit to Page** is selected as **Reduce/Enlarge**.

- 4 Select **Fit to Roll Paper Width**.

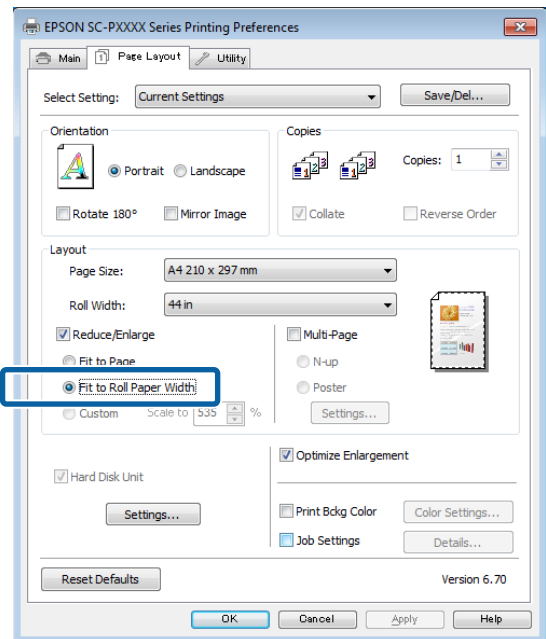

- 5 Select the width of the roll paper loaded in the printer from the **Roll Width** list.

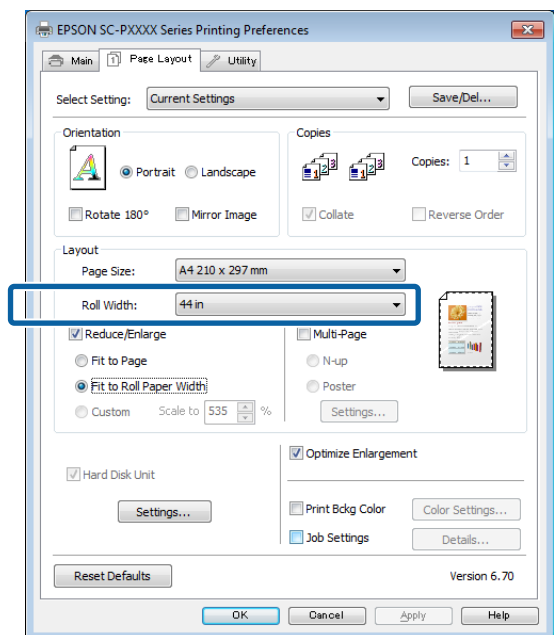

- 6 Check other settings, and then start printing.

## Custom Scale Setting

### Making Settings in Windows

- 1 When the printer driver's **Page Layout** screen is displayed, set the same paper size as the data's paper size in **Page Size** or **Paper Size**.

[“Printing \(Windows\)” on page 48](#)

## Printing Varieties

**2** Select the size of the paper loaded in the printer from the **Output Paper** list.

**Fit to Page** is selected as **Reduce/Enlarge**.

**3** Select **Custom**, and then set the **Scale** to value.

Enter a value directly or click the arrows to the right of the scale box to set the value.

Select the scale within a range of 10 to 650 %.

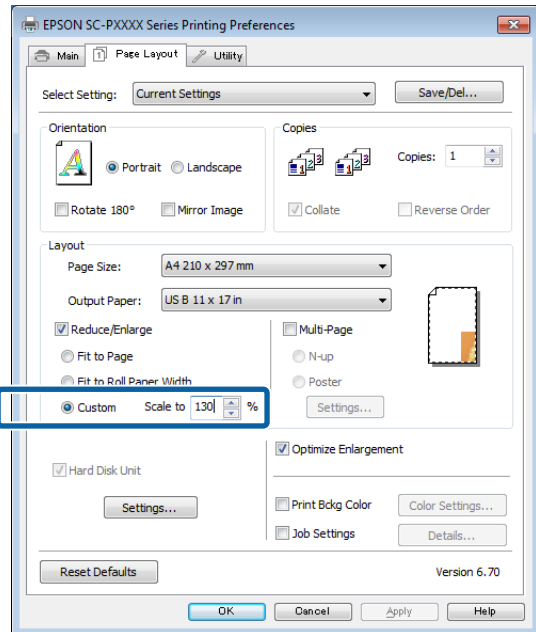

**4** Check other settings, and then start printing.

### Making Settings for Mac OS X

**1** When the Print screen is displayed, select the size of the paper loaded in the printer from the **Paper Size** list.

[“Printing \(Mac OS X\)” on page 49](#)

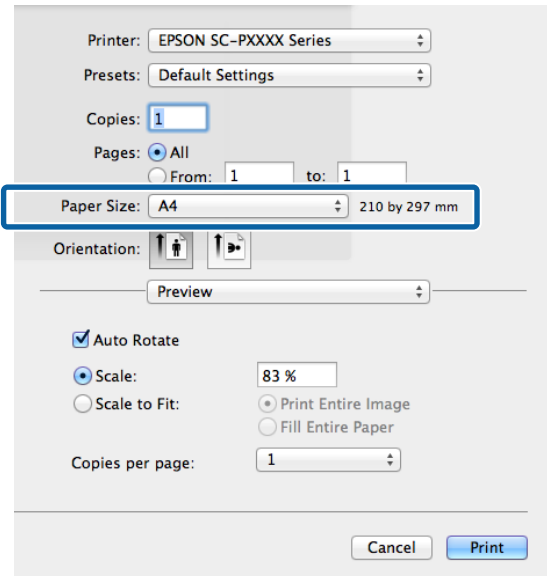

**2** Click **Scale**, and then enter the scale.

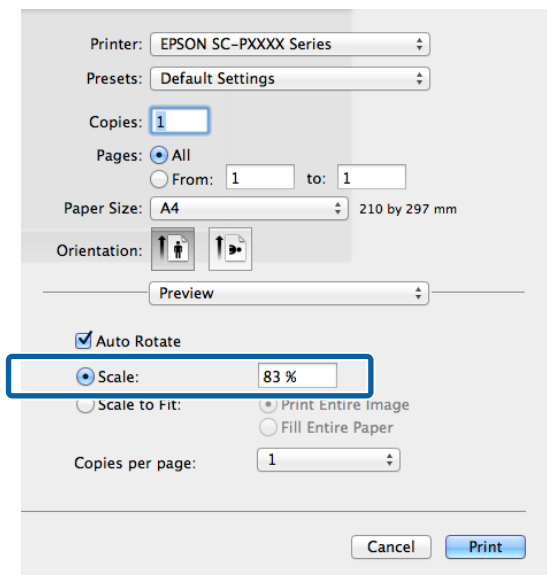

If the Print screen in the application you are using does not have an input item for the scale that you want to use, display the Page Setup screen and make settings.

## Printing Varieties

 [“Printing \(Mac OS X\)” on page 49](#)

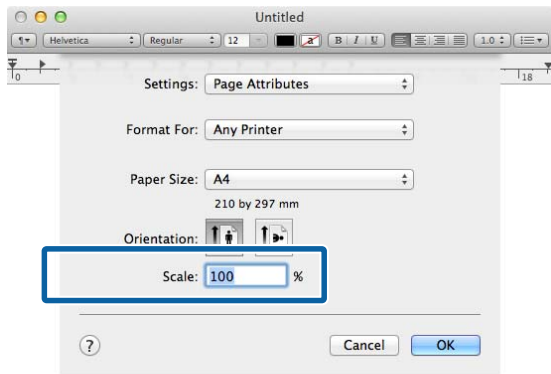

## Multi-Page Printing

You can print multiple pages of your document on one sheet of paper.

If you print continuous data prepared at A4 size, it is printed as shown below.

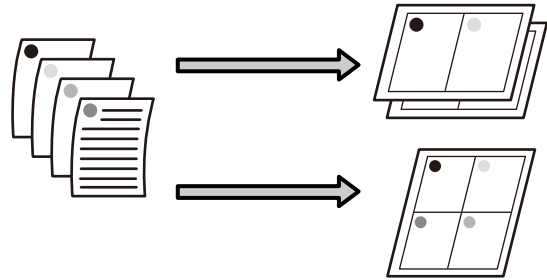

### Note:

- ❑ In Windows, you cannot use the Multi-Page printing function when performing borderless printing.
- ❑ In Windows, you can use the reduce/enlarge function (Fit to Page) to print the data on different sizes of paper.

 [“Enlarged/Reduced Printing” on page 82](#)

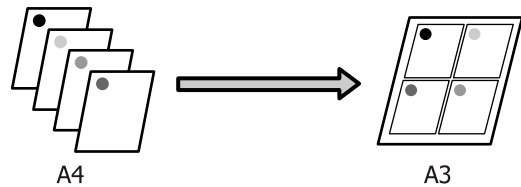

## Printing Varieties

### Making Settings in Windows

- 1 When the printer driver's **Page Layout** screen is displayed, select the **Multi-Page** check box, select **N-up**, and then click **Settings**.

“Printing (Windows)” on page 48

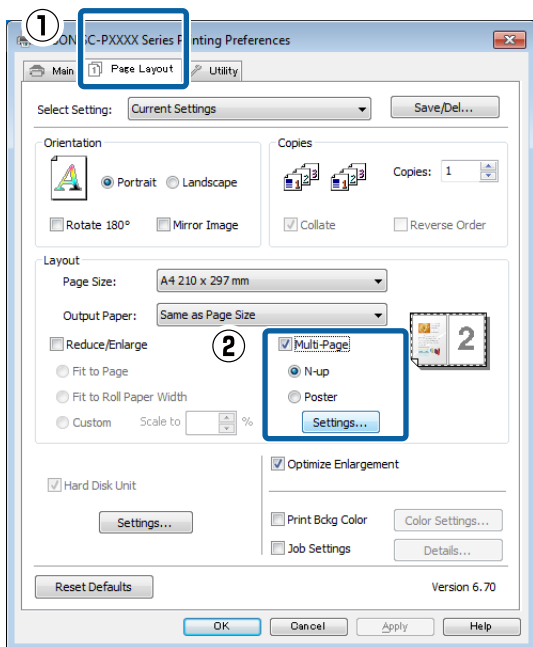

- 2 In the **Print Layout** screen, specify the number of pages per sheet and the page order.

If the **Print page frames** check box is selected, page frames are printed on each page.

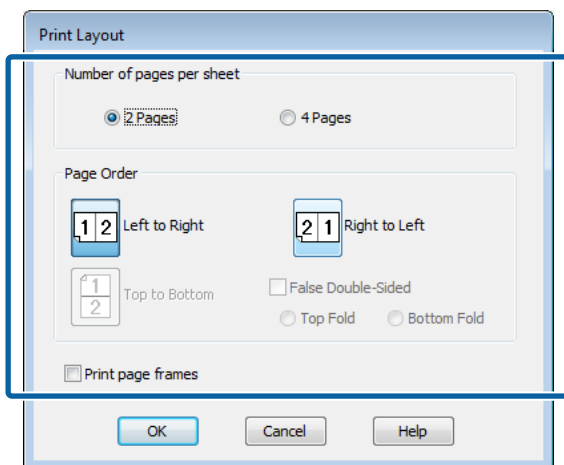

- 3 Check other settings, and then start printing.

### Making Settings for Mac OS X

- 1 When the Print screen is displayed, select **Layout** from the list, and then specify the number of pages per sheet and so on.

“Printing (Mac OS X)” on page 49

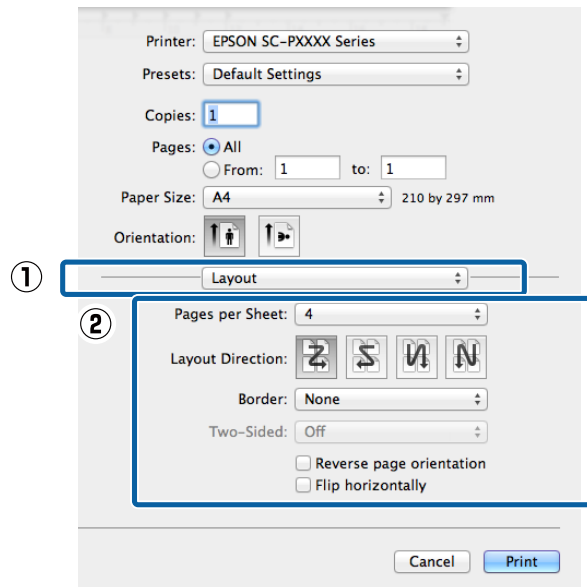

**Note:**

You can print frames around arranged pages using the **Border** function.

- 2 Check other settings, and then start printing.

Printing Varieties

# Poster Printing (Enlarge to cover several sheets and print - Windows only)

The poster printing function automatically enlarges and divides the print data. You can join the printed sheets to create a large poster or calendar. Poster printing is available up to 16-fold (four sheets by four sheets) of normal printing size. There are two ways to print posters.

- Borderless poster printing**  
This automatically enlarges and divides the print data and prints without margins. You can make a poster just by joining the output paper together. To perform borderless printing, the data is expanded so that it extends slightly over the paper size. Enlarged areas that exceed the paper are not printed. Therefore, the image may misalign at the joins. To join the pages precisely, perform the following poster printing with margins.



- Poster printing with margins**  
This automatically enlarges and divides the print data and prints with margins. You need to cut the margins and then join the output paper together to make a poster. Although the final size is slightly smaller since you have to cut off the margins, the image joins fit precisely.

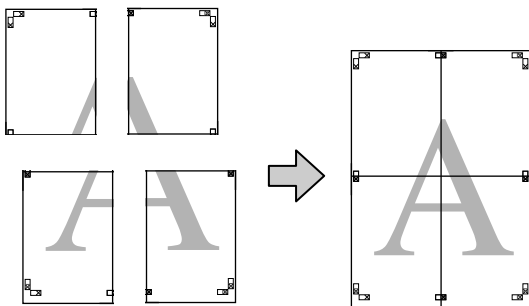

## Setting Procedures for Printing

- 1 Prepare the print data using applications.  
The printer driver automatically enlarges the image data when printing.
- 2 When the printer driver's **Page Layout** screen is displayed, select the **Multi-Page** check box, select **Poster**, and then click **Settings**.

➡ “Printing (Windows)” on page 48

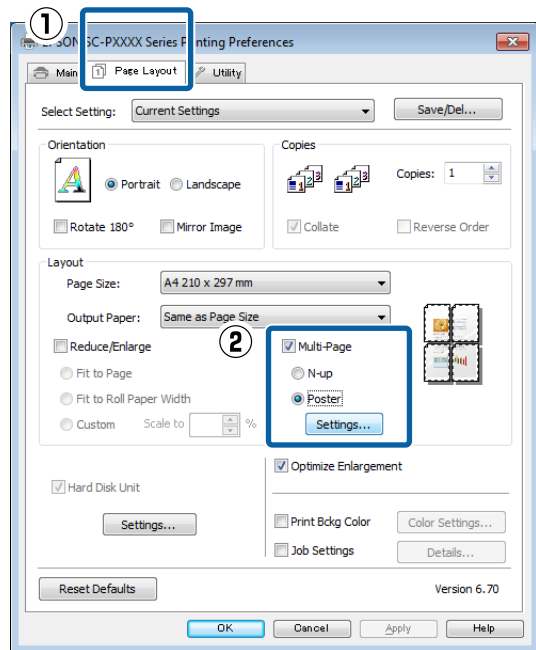

- 3 In the **Poster Settings** screen, select the number of pages you want in the poster.

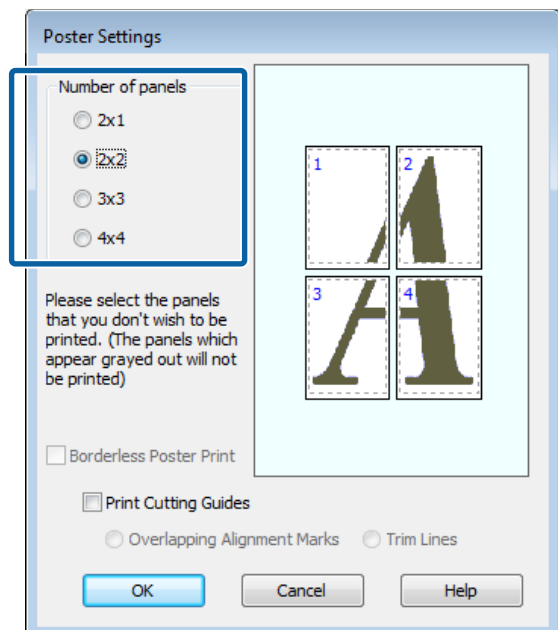



## Printing Varieties

- 4** Select borderless poster printing or poster printing with margins, and then select any pages that you do not want to print.

**When borderless is selected:**  
Select **Borderless Poster Print**.

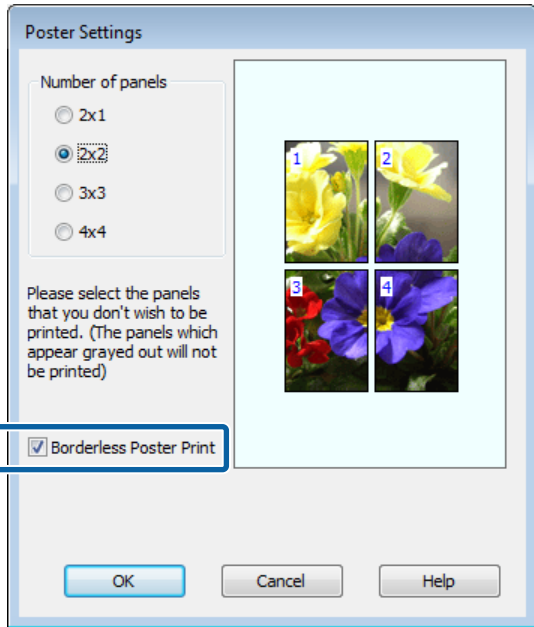

**Note:**

If **Borderless Poster Print** is grayed out, the selected paper or the size does not support borderless printing.

[“Epson Special Media Table” on page 159](#)

[“Supported Commercially Available Paper” on page 176](#)

**When with margins is selected:**  
Clear **Borderless Poster Print**.

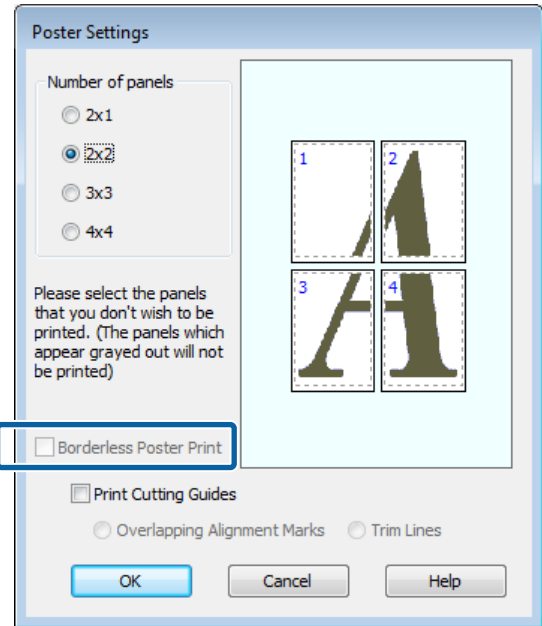

**Note:**

Regarding the size after joining together:

When **Borderless Poster Print** is cleared and printing with margins is selected, the **Print Cutting Guides** items are displayed.

The finished size is the same whether or not **Trim Lines** is selected. However, if **Overlapping Alignment Marks** is selected, the finished size is smaller with an overlap.

- 5** Check other settings, and then start printing.

**Printing Varieties**

**Joining the output paper together**

The steps for joining the output paper together differ between borderless poster printing and poster printing with margins.

**Borderless poster printing**

This section describes how to join four printed pages together. Check and match the printed pages, and join them in the order indicated below using an adhesive tape on the back of the sheets.

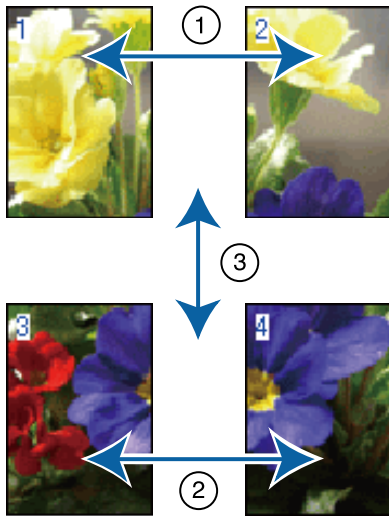

**Poster printing with margins**

If **Overlapping Alignment Marks** is selected, join guides (indicated by the lines drawn through and around the X marks in the illustration below) will be printed on each sheet.

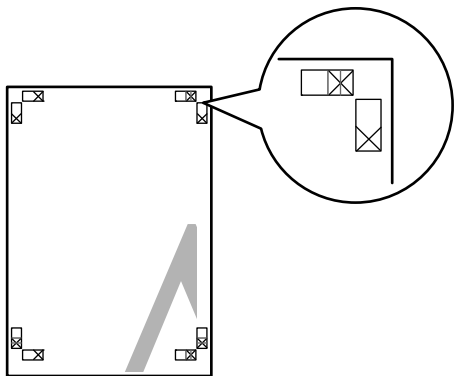

**Note:**  
The alignment marks are black for black-and-white printing.

The following section describes how to join four printed pages together.

- 1 Ready the two top sheets and trim the excess from the left sheet by cutting along the line joining the two join guides (the centers of the X marks).

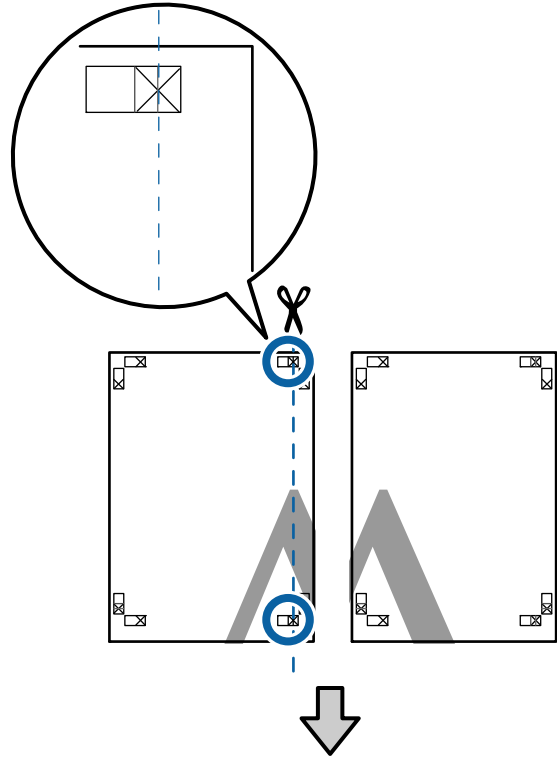

- 2 Lay the upper left sheet on top of upper right sheet. Lineup the X marks as shown in the illustration below, and temporarily fasten them using an adhesive tape on the back.

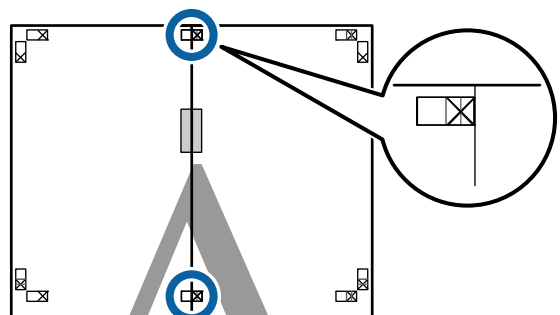

### Printing Varieties

- 3** With the two sheets overlapping, trim the excess by cutting along the line joining the two cut guides (the lines to the left of the X marks).

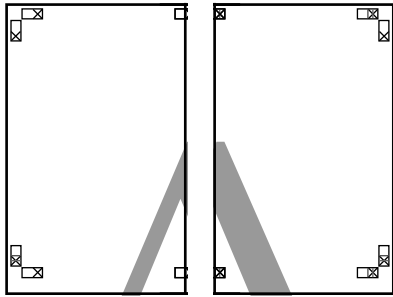
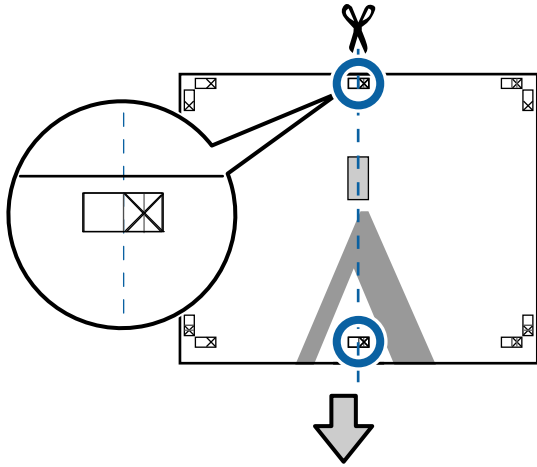

- 4** Rejoin the two sheets.  
Use an adhesive tape to stick the backs of the sheets together.

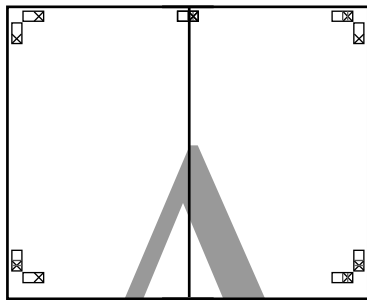

- 5** Repeat Steps 1 to 4 for the lower sheets.

- 6** Trim the bottom from the upper sheets by cutting along the line joining the two guides (the lines above the X marks).

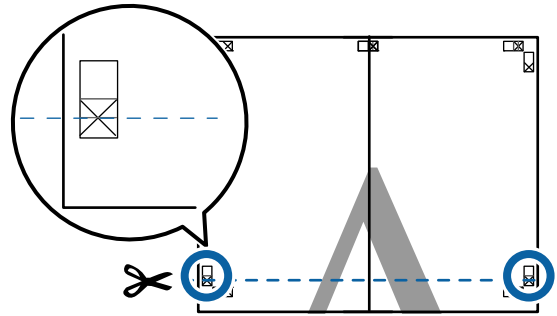

- 7** Lay the upper sheet on top of the lower sheet. Lineup the X marks as shown in the illustration below, and temporarily fasten them using an adhesive tape on the back.

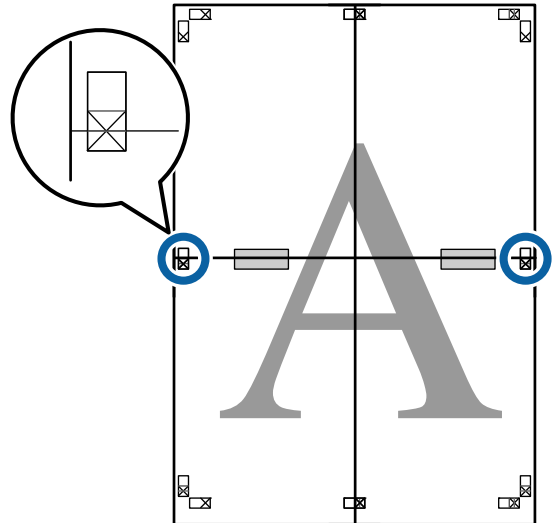

### Printing Varieties

- 8** With the two sheets overlapping, trim the excess by cutting along the line joining the two cut guides (the lines above the X marks).

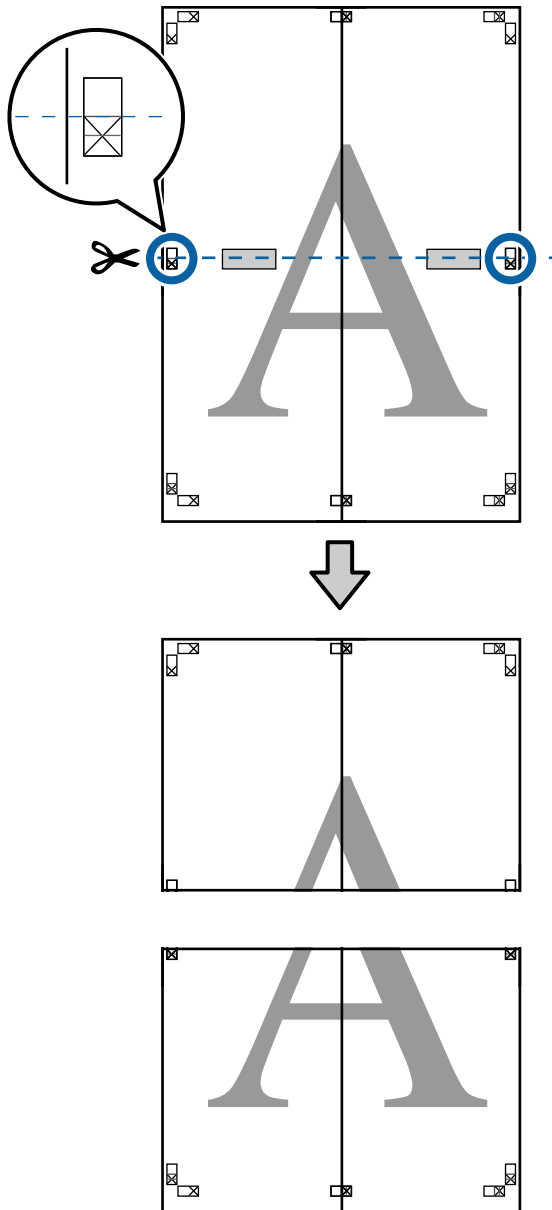

- 9** Join the upper and lower sheets together. Use an adhesive tape to stick the backs of the sheets together.

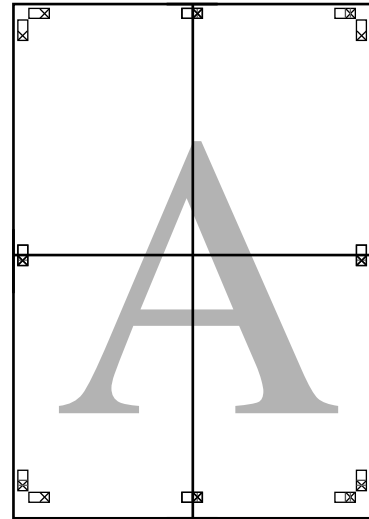

## Printing Varieties

- 10** After joining all the sheets, trim off the borders by cutting along the cut guides (outside the X marks).

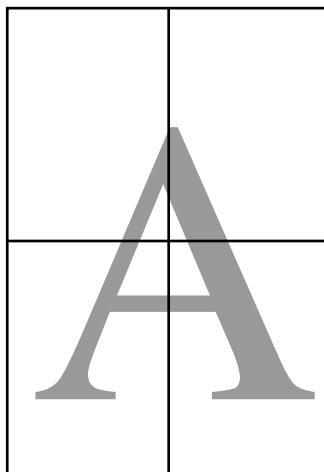
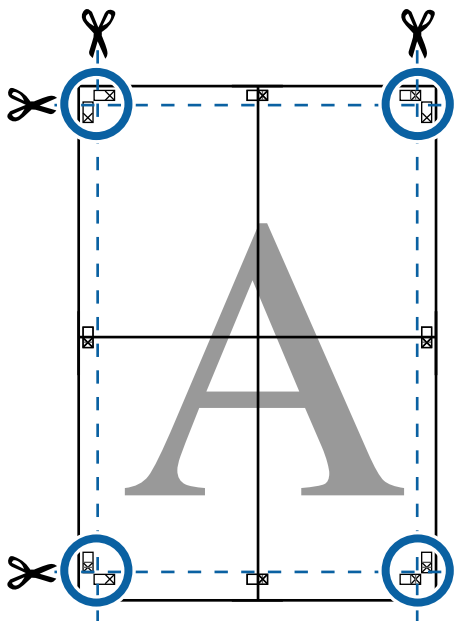

## Printing at Non-Standard Sizes

Before printing at non-standard sizes, including vertical or horizontal banners and documents with equal sides, save the desired paper size in the printer driver. Once they have been saved in the printer driver, custom sizes can be selected in the application **Page Setup** and other print dialogs.



### Supported paper sizes

The following table shows the paper sizes that can be set in the printer driver. See the following for paper sizes supported by the printer.

["Printable area" on page 52](#)

Paper Width	SC-P9000 Series/ SC-P8000 Series	89*1 to 1118 mm
	SC-P7000 Series/ SC-P6000 Series	89*1 to 610 mm
Paper Height	Windows: 127*1 to 15000 mm Mac OS X: 127*1 to 15240 mm*2	

- \*1 The smallest size supported by the printer is 182 mm wide by 254 mm long. If a smaller size is entered in the printer driver as a Custom Paper Size, the document will print with wider-than-expected margins, which must be trimmed.
- \*2 For Mac OS X **Custom Paper Sizes**, although you can specify a large paper size which cannot be loaded on this printer, it will not be printed properly.

## Printing Varieties

### Important:

When using commercially available software, the possible output sizes are restricted. If you are using applications that support banner printing, you can set a longer paper length. See the application's manual for details.

### Making Settings in Windows

**1** When the printer driver's **Main** screen is displayed, click **User Defined**.

 "Printing (Windows)" on page 48

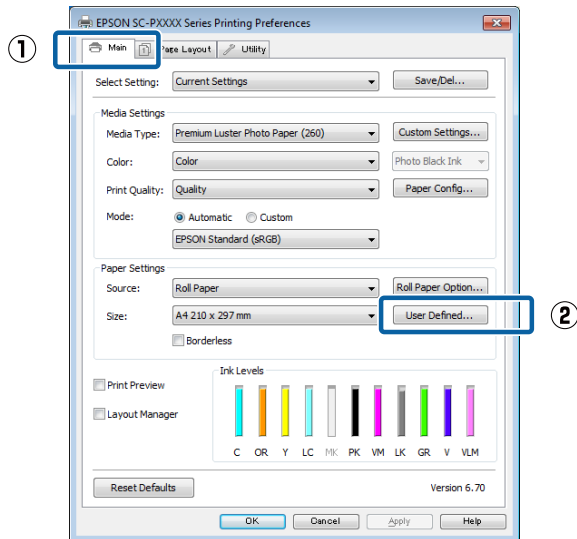

**2** In the **User Defined Paper Size** screen, set the paper size you want to use, and then click **Save**.

- You can enter up to 24 single-byte characters for the **Paper Size Name**.
- The length and width values for a pre-defined size close to the desired custom size can be displayed by selecting the appropriate option in the **Base Paper Size** menu.

- If the length and width ratio is the same as a defined paper size, select the defined paper size from **Fix Aspect Ratio** and select either **Landscape** or **Portrait** for the **Base**. In this case, you can only adjust either the paper width or paper height.

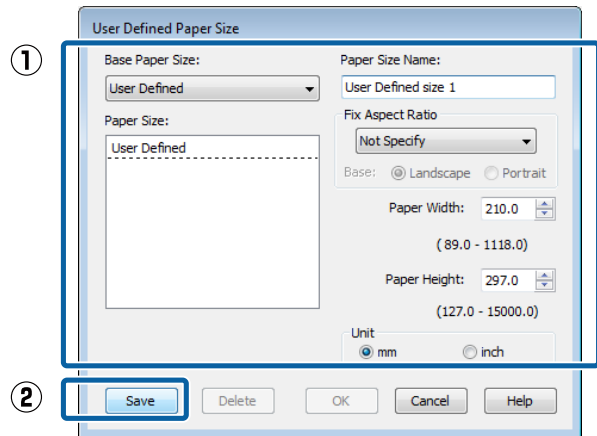

### Note:

- To change the paper size you saved, select the paper size name from the list on the left.
- To delete the user-defined size you saved, select the paper size name from the list on the left, and then click **Delete**.
- You can save up to 100 paper sizes.

**3** Click **OK**.

You can now select the new paper size from the **Size** menu in the **Main** tab.

You can now print as normal.

### Making Settings for Mac OS X

**1** When the Print screen is displayed, select **Manage Custom Sizes** from the **Paper Size** list.

If page setting options are not available in the application's print dialog, display the page settings dialog.

## Printing Varieties

 "Printing (Mac OS X)" on page 49

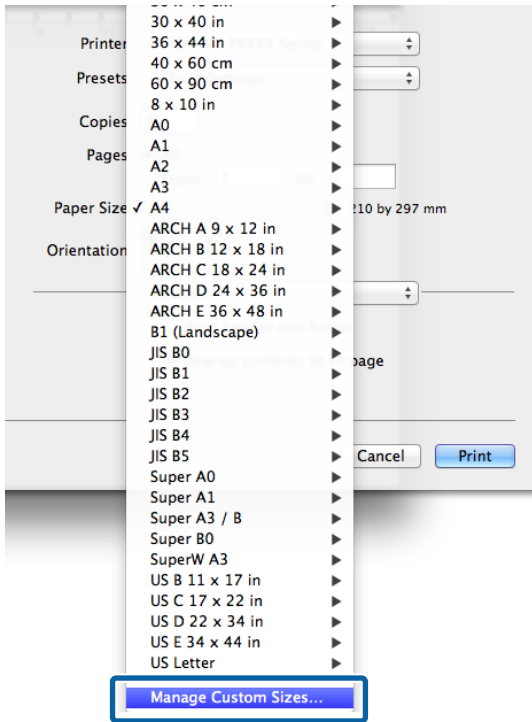

**Note:**

- To edit a saved custom size, choose its name from the list on the left.
- To copy a saved custom size, select the size in the list on the left and click **Duplicate**.
- To delete a saved custom size, select it in the list on the left and click **-**.
- The custom paper size setting differs depending on the operating system version. See your operating system's documentation for details.

**4**

Click **OK**.

You can select the paper size you saved from the Paper Size pop-up menu.

You can now print as normal.

**2** Click **+**, and then enter the paper size name.

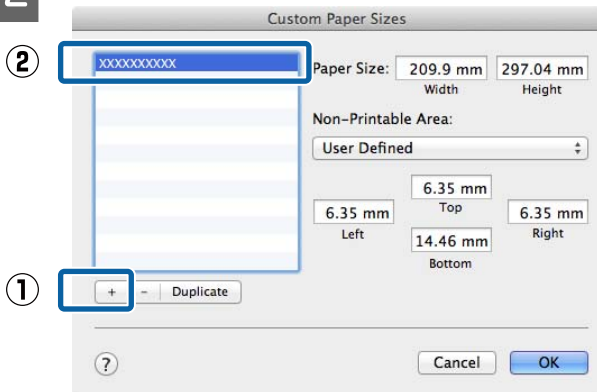

**3** Enter the **Width**, **Height** for the **Paper Size**, enter the margins, and then click **OK**.

You can set the page size and printer margins depending on the printing method.

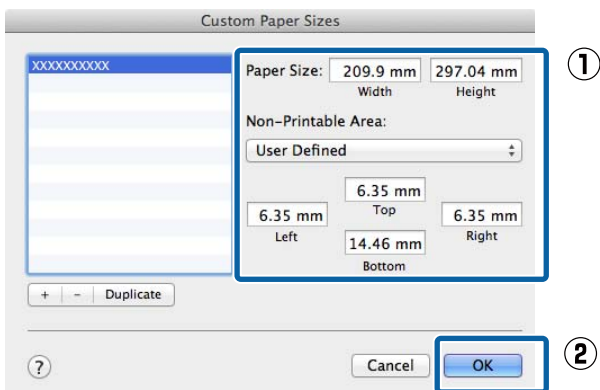

Printing Varieties

# Banner printing (on roll paper)

You can print banners and panoramic pictures if you create and set print data for banner printing in your application.

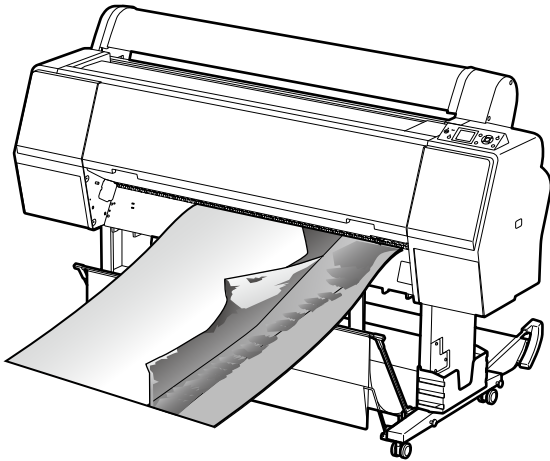

There are two ways to print a banner.

Printer Driver Source	Supported Applications
Roll Paper	Document preparation software, image editing software, and so on*
Roll paper (Banner)	Applications that support banner printing

\* Create print data at a size supported by the given application while maintaining the printing length and width ratio.

See the following for available paper sizes.

[“Printing at Non-Standard Sizes” on page 93](#)

## Making Settings in Windows

**1** In the printer driver's Main screen, select **Media Type**.

[“Printing \(Windows\)” on page 48](#)

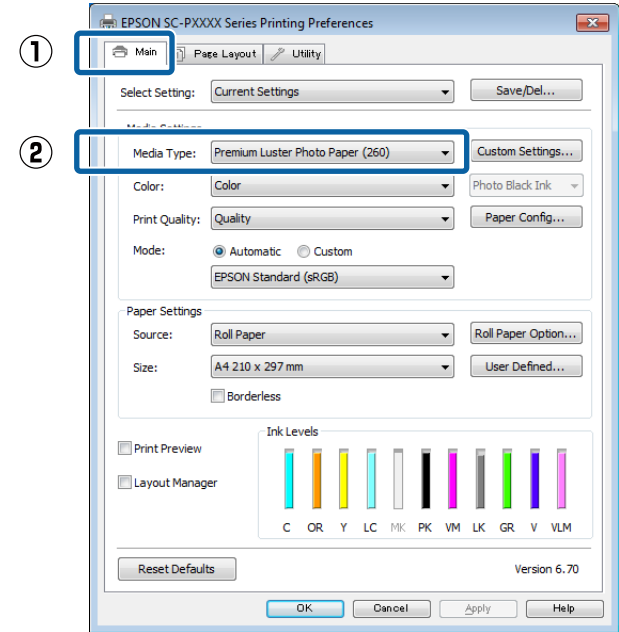

**2** Select **Roll Paper** or **Roll Paper (Banner)** from the **Source** list.

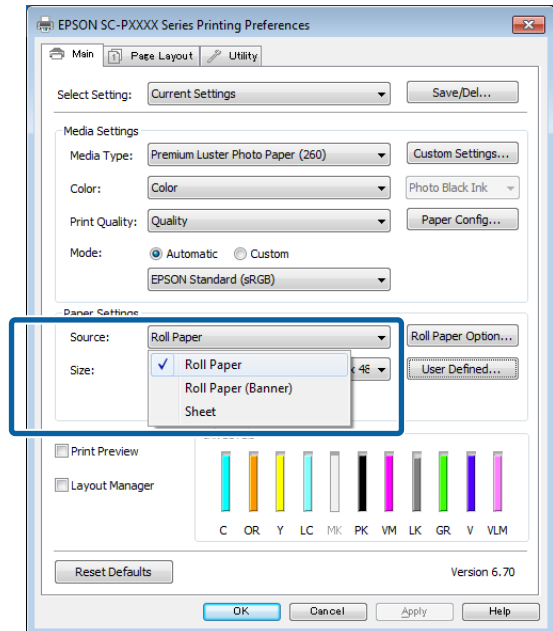

**Note:**

- You can only use **Roll Paper (Banner)** for applications that support banner printing.
- Selecting **Roll Paper (Banner)** sets the top and bottom margins of the paper to 0 mm.



## Printing Varieties

- 3 Click **User Defined** and match the paper size to the size of the data if necessary.

**Note:**  
 If you are using applications that support banner printing, you do not need to set **User Defined Paper Size** if you select **Roll Paper (Banner)** as the **Source**.

- 4 On the Page Layout screen make sure the **Optimize Enlargement** check box is selected.

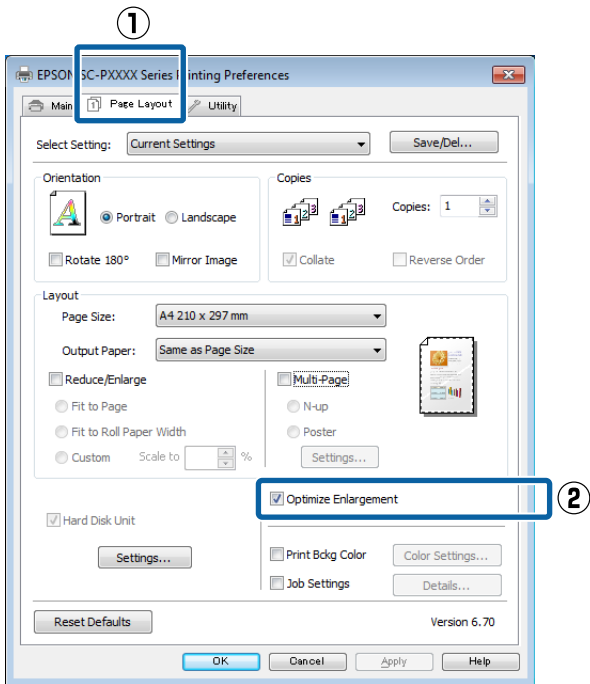

- 5 Check other settings, and then start printing.

### Making Settings for Mac OS X

- 1 When the Print screen is displayed, select the size of the data created with the application in **Paper Size**.

If page setting options are not available in the application's print dialog, display the page settings dialog.

☞ “Printing (Mac OS X)” on page 49

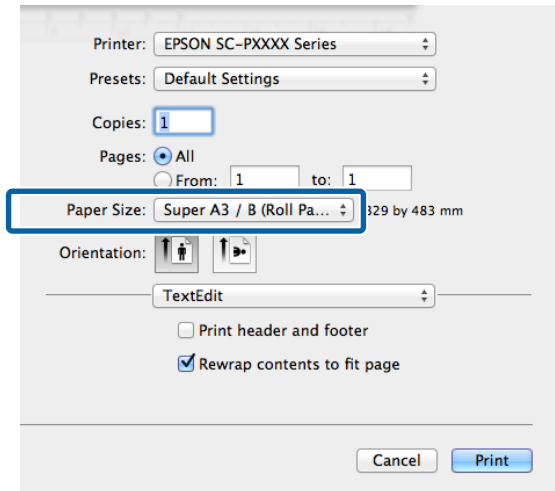

- 2 Check other settings, and then start printing.

## Printing Varieties

# Layout Manager (Windows Only)

The Layout Manager function allows you to place multiple pieces of print data created in different applications on the paper freely and print them at once.

You can create a poster or display material by placing multiple pieces of print data where you like. Also, Layout Manager allows you to use paper effectively.

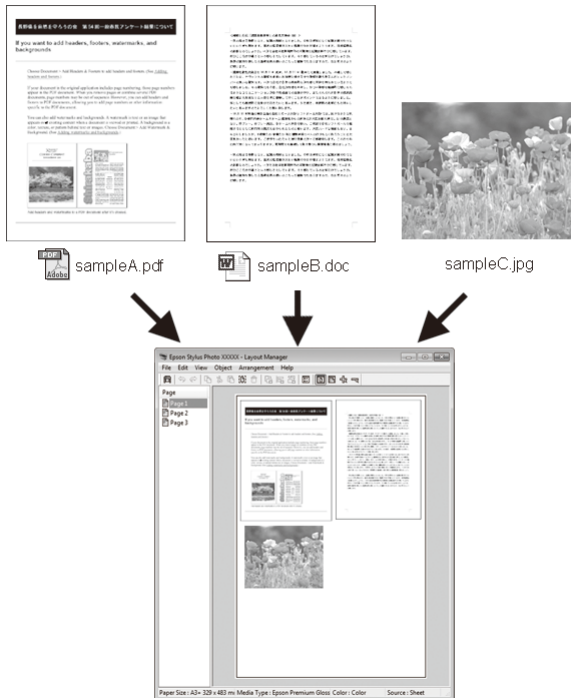

The following is a layout example.

### Placing multiple data items

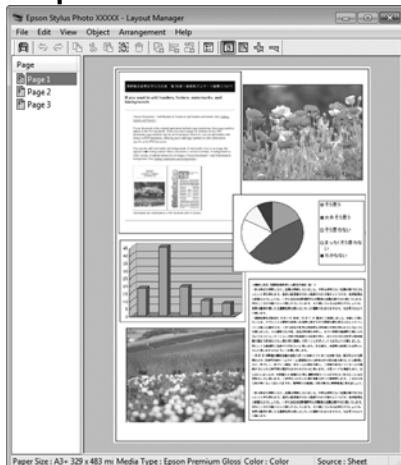

### Placing the same data

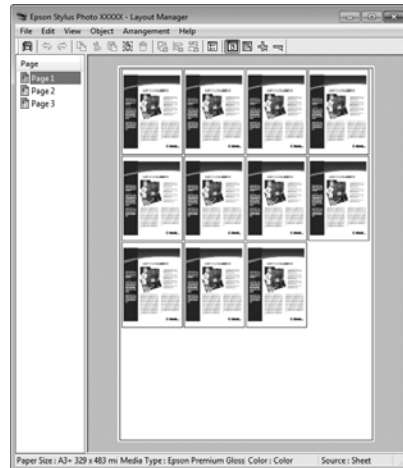

### Placing data freely

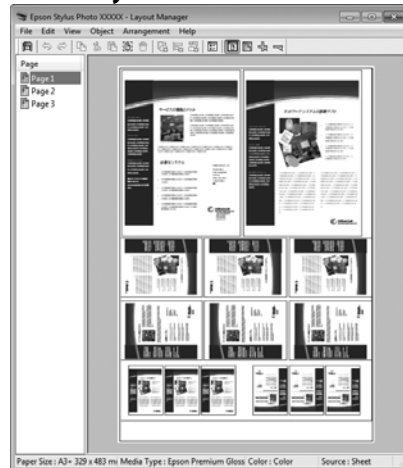

### Placing data on roll paper

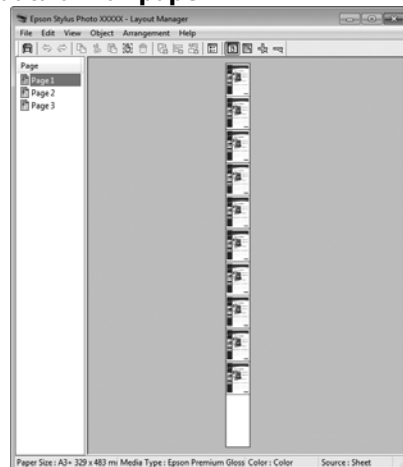

## Setting Procedures for Printing

1

Check that the printer is connected and ready to print.

## Printing Varieties

- 2 Open the file you want to print in your application.
- 3 Select **Layout Manager** in the **Main** tab of the printer driver and choose an option for **Size** that matches the size of the document created in the application.

"Printing (Windows)" on page 48

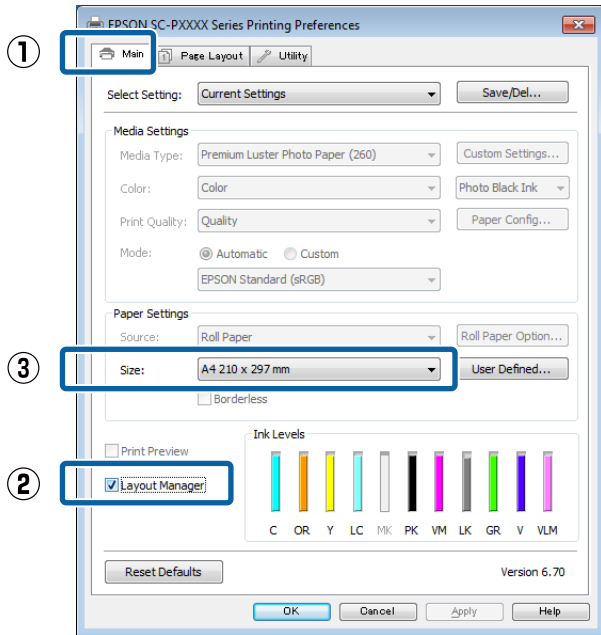

**Note:**

The option selected for **Size** is the size used in the **Layout Manager**. The actual printing paper size is set in the screen in Step 7.

- 4 Click **OK**. When printing with an application, the **Layout Manager** screen opens.  
The print data is not printed, but one page is placed on the paper of the **Layout Manager** screen as one object.
- 5 Leave the **Layout Manager** screen open and repeat steps 2 to 4 to arrange the next pieces of data.  
The objects are added to the **Layout Manager** screen.
- 6 Arrange the objects on the **Layout Manager** screen.  
Objects can be dragged to new positions and resized; in addition, they can be rearranged or rotated using the options in the Object menu.

The overall size and placement of the objects can be changed using the **Preferences** and **Arrangement** options in the File menu.

See the **Layout Manager** screen help for more details on each function.

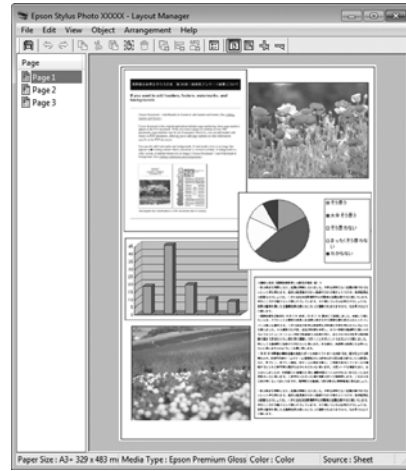

## Printing Varieties

- Click **File - Properties**, and make print settings on the printer driver screen.

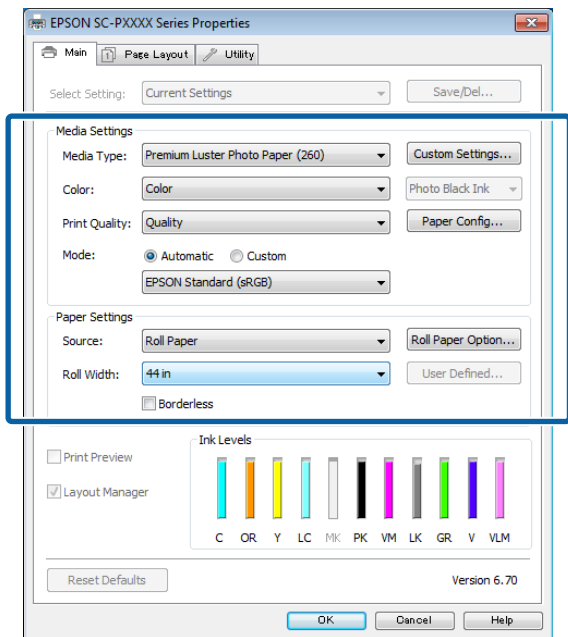
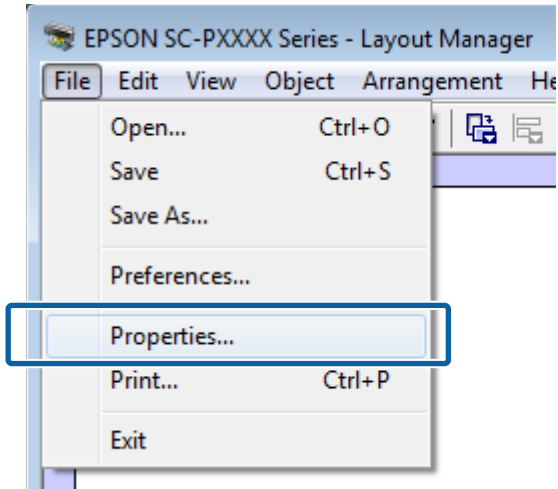

Set **Media Type, Source, Size or Roll Width**, and so on.

- Click the **File** menu on the **Layout Manager** screen, and then click **Print**.

Printing starts.

## Saving and Recalling Settings

You can save the **Layout Manager** screen arrangement and setting contents to a file. If you need to close your application in the middle of a job, you can save it to a file and then open it later to continue your work.

## Saving

- On the **Layout Manager** screen, click **File** menu and then **Save as**.
- Enter the file name, select the location, and then click **Save**.
- Close the **Layout Manager** screen.

## Opening saved files

- Right-click the utility icon (  ) in the Windows taskbar and select **Layout Manager** from the menu that appears.

The **Layout Manager** screen is displayed.

If the Utility shortcut icon is not displayed on the Windows Taskbar  “[Summary of the Utility Tab](#)” on page 66

- On the **Layout Manager** screen, click **File** menu and then **Open**.
- Select the location and open the required file.

## Color Management Printing

# Color Management Printing

## About Color Management

Even when using the same image data, the original image and the displayed image may look different, and the printed results may look different to the image you see on the display. This occurs due to the difference in characteristics when input devices such as scanners and digital cameras capture colors as electronic data, and when output devices such as display screens and printers reproduce colors from the color data. The color management system is a means to adjust differences in color conversion characteristics among input and output devices. As well as applications for image processing, each operating system is equipped with a color management system, such as ICM for Windows and ColorSync for Mac OS X.

In a color management system, a color definition file called a "Profile" is used to perform color matching between devices. (This file is also called an ICC profile.) The profile of an input device is called an input profile (or source profile), and the profile of an output device, such as a printer, is called a printer profile (or output profile). A profile is prepared for each media type in this printer's driver.

The color conversion areas by the input device and the color reproduction area by the output device differ. As a result, there are color areas that do not match even when performing color matching using a profile. In addition to specifying profiles, the color management system also specifies conversion conditions for areas where color matching failed as "intent". The name and type of intent vary depending on the color management system you are using.

You cannot match the colors on the printed results and display by color management between the input device and the printer. To match both colors, you need to perform color management between the input device and the display as well.

## Color Management Print Settings

You can perform color management printing using this printer's printer driver in the following two ways.

Choose the best method according to the application you are using, the operating system environment, the aim of the print out, and so on.

### Setting color management with the applications

This method is for printing from applications that support color management. All color management processes are carried out by the application's color management system. This method is useful when you want to obtain the same color management print results using a common application among different operating system environments.

[☞ “Setting color management with the applications” on page 102](#)

### Setting color management with the printer driver

The printer driver uses the operating system's color management system and carries out all color management processes. You can make color management settings in the printer driver using the following two methods.

- ❑ Host ICM (Windows) / ColorSync (Mac OS X)  
Set when printing from applications that support color management. This is effective in producing similar print results from different applications under the same operating systems.  
[☞ “Color management printing by Host ICM \(Windows\)” on page 104](#)  
[☞ “Color management printing by ColorSync \(Mac OS X\)” on page 105](#)
- ❑ Driver ICM (Windows only)  
This allows you to perform color management printing from applications that do not support color management.  
[☞ “Color management printing by Driver ICM\(Windows Only\)” on page 105](#)

**Color Management Printing**

**Setting profiles**

Settings for the input profile, printer profile, and intent (matching method) vary between three types of color management printing since their color management engines are used differently. This is because color management usage differs between the engines. Make settings in the printer driver or application as described in the following table.

	Input profile settings	Printer profile settings	Intent settings
Driver ICM (Windows)	Printer Driver	Printer Driver	Printer Driver
Host ICM (Windows)	Application	Printer Driver	Printer Driver
ColorSync (Mac OS X)	Application	Printer Driver	Application
Application	Application	Application	Application

Printer profiles for each paper type that is needed when performing color management are installed with the printer's printer driver. You can select the profile from the printer driver's settings screen.

You can select the profile from the printer driver's settings screen.

[“Color management printing by Driver ICM\(Windows Only\)” on page 105](#)

[“Color management printing by Host ICM \(Windows\)” on page 104](#)

[“Color management printing by ColorSync \(Mac OS X\)” on page 105](#)

[“Setting color management with the applications” on page 102](#)

**Setting color management with the applications**

Print using applications with a color management function. Make the color management settings in the application and disable the printer driver's color adjustment function.

**1** Make color management settings in the applications.

Setting example for Adobe Photoshop CS5

Open the **Print** screen.

Select **Color Management** and then **Document**. Select **Photoshop Manages Colors** as the **Color Handling** setting, select the **Printer Profile** and the **Rendering Intent**, and then click **Print**.

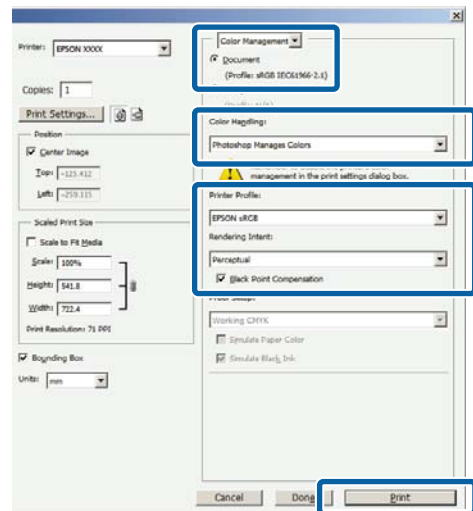

**2** Display the printer driver's settings screen (Windows) or Print screen (Mac OS X).

Make printer driver settings.

**For Windows**

[“Printing \(Windows\)” on page 48](#)

**For Mac OS X**

[“Printing \(Mac OS X\)” on page 49](#)

### Color Management Printing

**3** Set color management to off.

#### For Windows

In the **Main** screen, select **Custom** as the **Mode** setting, and select **Off (No Color Adjustment)**.

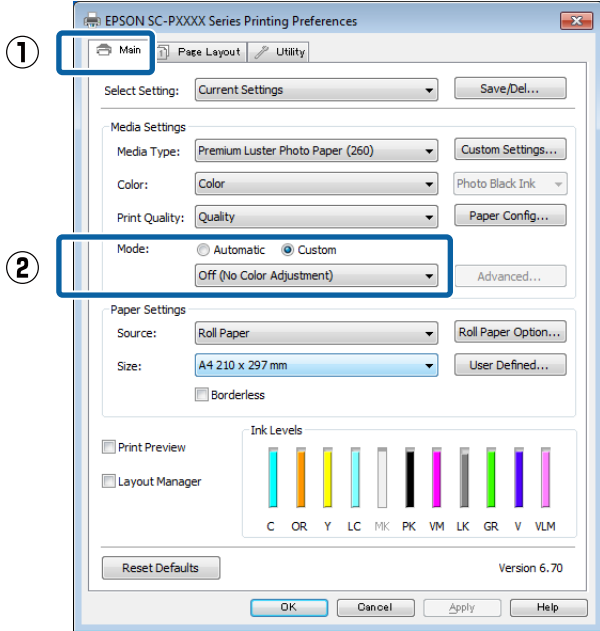

**Note:**  
 In Windows 7, Windows Vista, and Windows XP (Service Pack 2 or later and .NET 3.0) **Off (No Color Adjustment)** is selected automatically.

#### For Mac OS X

Select **Print Settings** from the list, and then select **Off (No Color Adjustment)** as the **Color Settings** setting.

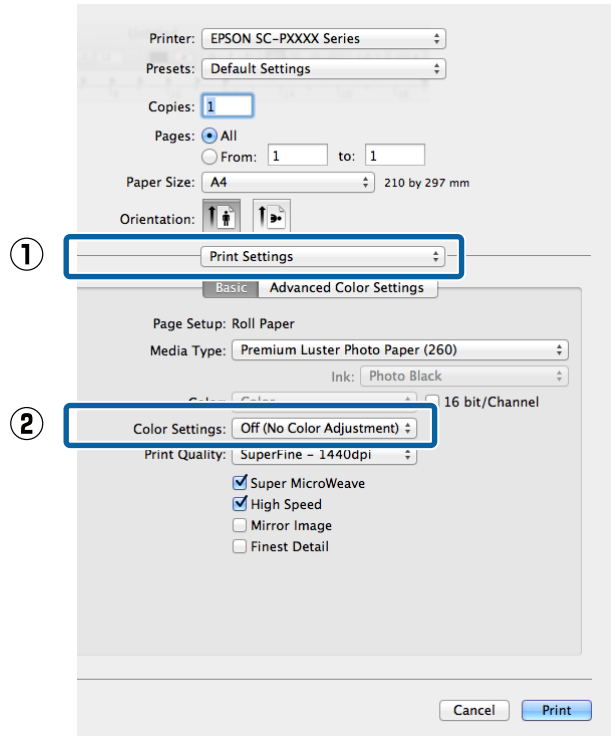

**4** Check other settings, and then start printing.

## Color Management Printing

# Setting color management with the printer driver

## Color management printing by Host ICM (Windows)

Use image data in which an input profile has been embedded. Also, the application must support ICM.

- 1 Make the settings for color adjustment using the application.

Depending on the type of the application, make the settings following the table below.

Adobe Photoshop CS3 or later  
 Adobe Photoshop Elements 6.0 or later  
 Adobe Photoshop Lightroom 1 or later

OS	Color Management Settings
Windows 8.1, Windows 8, Windows 7, Windows Vista	Printer Manages Colors
Windows XP (Service Pack 2 or later and .NET 3.0 or later)	
Windows XP (other than the above)	No Color Management

In other applications, set **No Color Management**.

**Note:**

For information on supported platforms, see the website for the application in question.

Setting example for Adobe Photoshop CS5

Open the **Print** screen.

Select **Color Management** and then **Document**. Select **Printer Manages Colors** as the **Color Handling** setting, and then click **Print**.

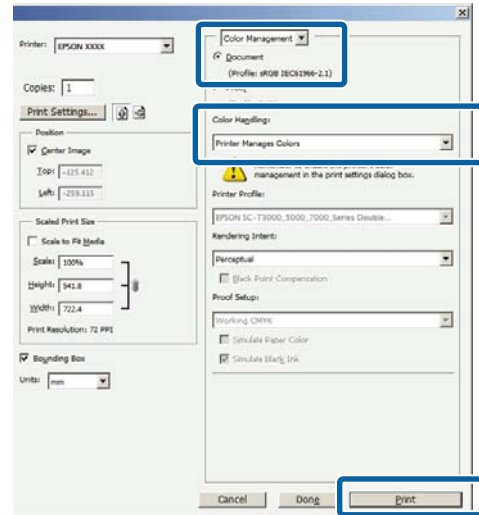

When using applications without a color management function, start from step 2.

- 2 In the printer driver's **Main** screen, select **Custom** as the **Mode**, select **ICM**, and then click **Advanced**.

☞ ["Printing \(Windows\)" on page 48](#)

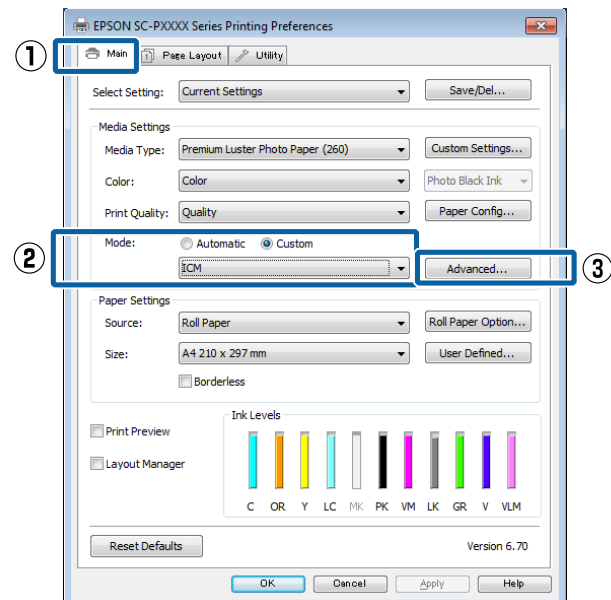

- 3 Select **ICM Mode** in Printer Color Adjustment. See the printer driver help for more details.



## Color Management Printing

When Epson special media is selected for **Media Type** in the **Main** screen, the printer profile corresponding to the media type is automatically selected and displayed in the **Printer Profile Description** box.

To change the profile, select **Show all profiles** at the bottom.

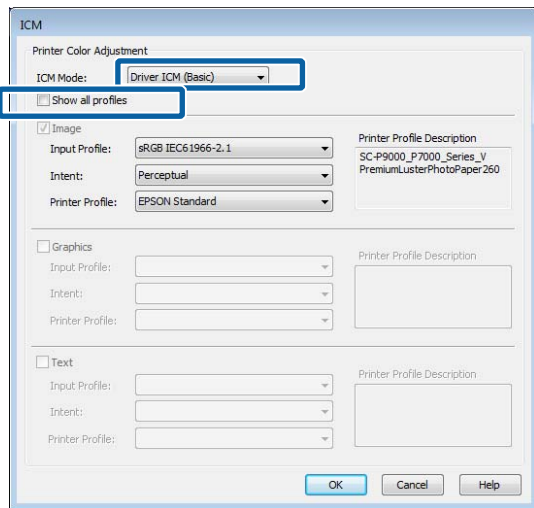

**4** Check other settings, and then start printing.

### Color management printing by ColorSync (Mac OS X)

Use image data in which an input profile has been embedded. Also, the application must support ColorSync.

**Note:**

Depending on the application, color management printing by **ColorSync** may not be supported.

**1** Disable the color management functions in the application.

**2** Display the Print screen.

[“Printing \(Mac OS X\)” on page 49](#)

**3** Select **Color Matching** from the list, and then click **ColorSync**.

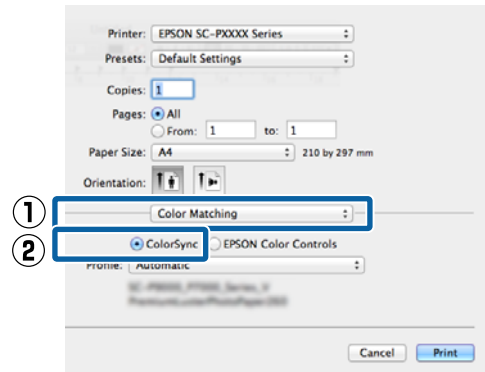

**4** Check other settings, and then start printing.

### Color management printing by Driver ICM (Windows Only)

The printer driver uses its own printer profiles to perform color management. You can use the following two color correction methods.

- Driver ICM (Basic)**  
Specify one type of profile and intent for processing the entire image data.
- Driver ICM (Advanced)**  
The printer driver distinguishes the image data into the **Image**, **Graphics**, and **Text** areas. Specify three types of profiles and intents for processing each area.

#### When using applications featuring a color management function

Make the settings for color processing using the application before making printer driver settings.

Depending on the type of the application, make the settings following the table below.

- Adobe Photoshop CS3 or later
- Adobe Photoshop Elements 6.0 or later
- Adobe Photoshop Lightroom 1 or later

### Color Management Printing

OS	Color Management Settings
Windows 8.1, Windows 8, Windows 7, Windows Vista	Printer Manages Colors
Windows XP (Service Pack 2 or later and .NET 3.0 or later)	
Windows XP (other than the above)	No Color Management

In other applications, set **No Color Management**.

**Note:**  
For information on supported platforms, see the website for the application in question.

Setting example for Adobe Photoshop CS5

Open the **Print** screen.

Select **Color Management** and then **Document**. Select **Printer Manages Colors** as the **Color Handling** setting, and then click **Print**.

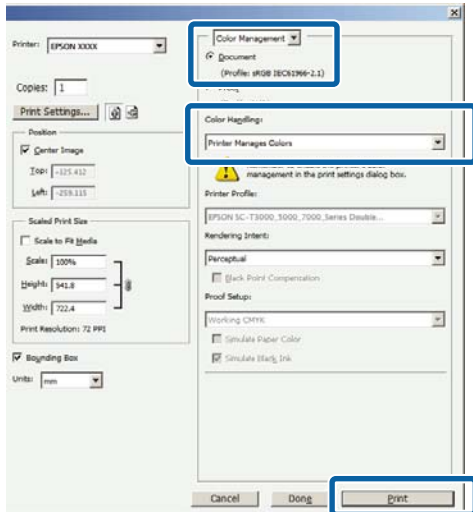

- 1 In the printer driver's **Main** screen, select **Custom** as the **Mode**, select **ICM**, and then click **Advanced**.

["Printing \(Windows\)" on page 48](#)

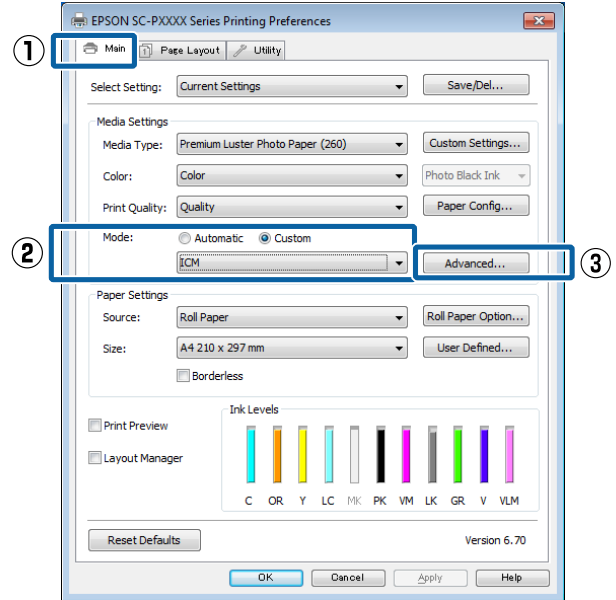

- 2 From **ICM Mode** in the **ICM** screen, select **Driver ICM (Basic)** or **Driver ICM (Advanced)**.

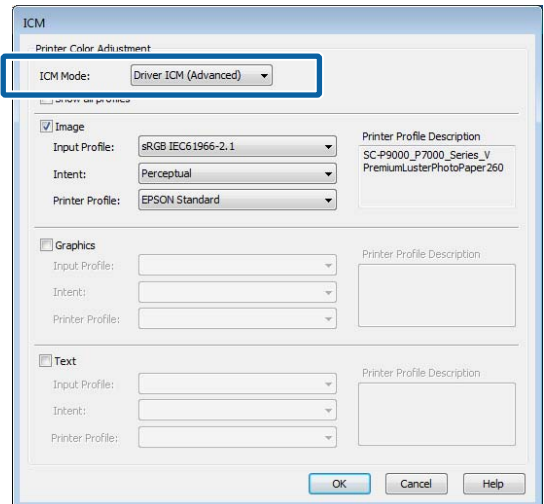

If you select **Driver ICM (Advanced)**, you can specify the profiles and intent for each image such as photos, graphics, and text data.

Intent	Explanation
Saturation	Keeps the current saturation unchanged and converts the data.

## Color Management Printing

Intent	Explanation
Perceptual	Converts the data so that a more visually natural image is produced. This feature is used when a wider gamut of color is used for image data.
Relative Colorimetric	Converts the data so that a set of color gamut and white point (or color temperature) coordinates in the original data match their corresponding print coordinates. This feature is used for many types of color matching.
Absolute Colorimetric	Assigns absolute color gamut coordinates to the original and print data and converts the data. Therefore, color tone adjustment is not performed on any white point (or color temperature) for the original or print data. This feature is used for special purposes such as logo color printing.

**3**

Check other settings, and then start printing.

Using the Control Panel Menu

# Using the Control Panel Menu

## Menu Operations

Operate the menus as shown below. The explanations use the Maintenance menu as an example.

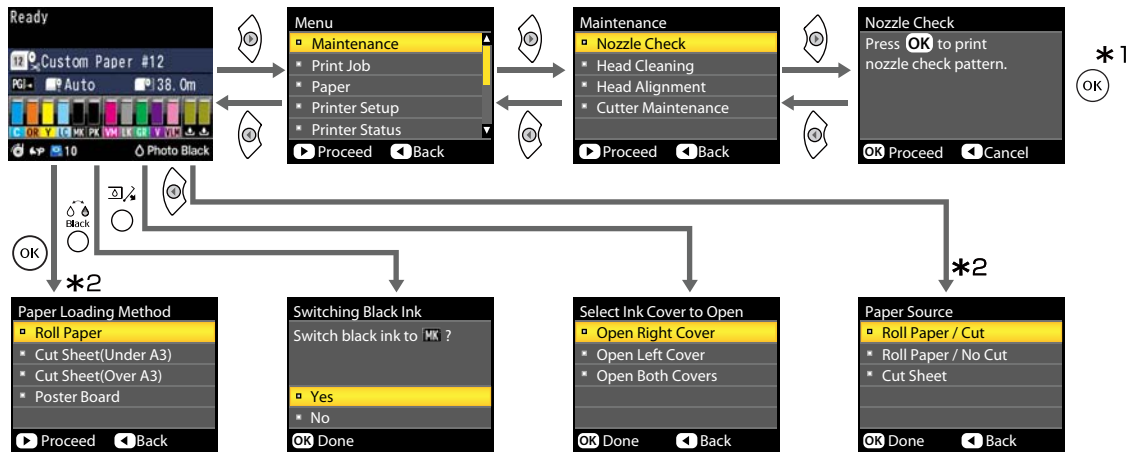

- \*1 After pressing the OK button to select the highlighted option, press the ◀ button to return to the previous menu. Press the ⏏ button to exit.
- \*2 Instructions are not displayed when paper is loaded.

## Using the Control Panel Menu

# Menu List

The items and options available in the menu are described below. See the reference pages for more details on each item.

## Maintenance menu

 [“Maintenance” on page 114](#)

Menu item			Description
Nozzle Check			Press OK to start printing.
Head Cleaning	All Nozzles	Normal, Heavy	Press OK to start cleaning.
	XX/XX (where XX indicates the ink color code)	Normal, Heavy	
Head Alignment	Auto	Uni-D, Bi-D 2-color, Bi-D All Color, Bi-D #1 to #4	Press OK to start printing/alignment.
	Manual	Uni-D, Bi-D 2-color, Bi-D All Color	Press OK to start printing.
Cutter Maintenance	Adjust Cut Position		-3 to 3mm
	Replace Cutter		Press OK to start move.

## Print Queues menu

This menu is only available when the optional hard disk unit is installed.

 [“Print Queues” on page 115](#)

Menu item			Description
Print Queue	XXXXXXXXXX (name of print queue)		Lists the Waiting Job Name, User, Estimated Start Time, and Estimated Print Time.
Hold Queue	View Hold Queue	XXXXXXXXXX (name of hold queue)	Lists the Paused Job Name, User, Paper Type, Source, Size, and Reason For Hold.
	Resume All Jobs		Press OK to start printing.
Saved Job Queue	XXXXXXXXXX (name of saved job queue)		Lists the Stored Job Name, User, Paper Length, Pages, Paper Type, Copies, Source, Size, and Estimated Print Time.  When the job name is selected and you press the ► button, the File Options menu is displayed.

### Using the Control Panel Menu

## Paper menu

Items marked with an asterisk (\*) are only available when the optional hard disk unit is installed.

 "Paper" on page 116

Menu item		Description
Select Paper Type	Photo Paper	Lists supported Epson media.
	Proofing Paper	
	Fine Art Paper	
	Matte Paper	
	Plain Paper	
	Others	
	Custom Paper	Lists the names of user-defined custom paper types.
Custom Paper Setting		-
XXXXXXXXXXXXXXXXXXXX		Lists the names of custom paper types.
Select Reference Paper	Photo Paper	Lists supported Epson media.
	Proofing Paper	
	Fine Art Paper	
	Matte Paper	
	Plain Paper	
	Others	
	No Paper Selected	-
Platen Gap		Narrow, Standard, Wide, Wider, Widest
Detect Paper Thickness		Press OK to start printing.
Paper Feed Adjust	Pattern	Press OK to start printing.
	Value	-0.70 to +0.70%
Paper Suction		-4 to 0
Drying Time Per Pass		0 to 10 sec
Roll Paper Tension		Normal, High, Extra High
Remove Skew		On, Off
Setting Name		22 characters or less (letters, numbers, and symbols)
Restore Settings		Yes, No
Print Paper List		Press OK to start printing.

## Using the Control Panel Menu

Menu item		Description
Roll Paper Remaining	Remaining Setup	On, Off
	Set Length	5.0 to 99.5m
	Set Alert Length	1 to 15m
Roll Paper Setup	Auto Cut	On, Off
	Page Line	On, Off
	Roll Paper Margin	Normal, Top15mm/Bottom15mm, Top 35 mm/Bottom 15 mm, Top 150 mm/Bottom 15 mm, 3mm,15mm
	Roll End Option	Continue, Stop Printing, Reprint*
	Roll Paper Tension	Lv1 to 5
	Refresh Margin	On, Off

## Printer Setup Menu

Items marked with an asterisk (\*) are only available when the optional hard disk unit is installed.

 [“Printer Setup” on page 120](#)

Menu item		Description
Platen Gap		Narrow, Standard, Wide, Wider, Widest
Paper Size Check		On, Off
Paper Skew Check		On, Off
Auto Nozzle Check	Auto Cleaning Setting	Periodically, Every Job, Off
	Auto Clean Max Repeat	1 to 3
Timer Cleaning		XX hours, Off
Print Nozzle Pattern		Every 10 pages, Every Page, Off
Auto Black Ink Change		On, Off
BK Ink Change Setting		Normal, Quick
Calibration Setting		On, Off
Store Held Job*		On, Off
Restore Settings		Yes, No

## Printer Status Menu

 [“Printer Status” on page 121](#)

## Using the Control Panel Menu

Menu item	Description
Firmware Version	xxxxxxx,xx.xx,xxxx
Option Status	Displays the options connected.
Print Status Sheet	Press OK to start printing.
Calibration Date	MM/DD/YY HH:MM

## Option Setup Menu

The following menus are only displayed when the optional SpectroProofer mounter or Auto Take-up Reel Unit are installed.

 [“Option Setup” on page 122](#)

Menu item	Description	
SpectroProofer	-	
SProofer Status	Device Version:ILS30	X-Rite ILS30EP vxxxx
	Calibration Tile S/N	xxxxxx
	Device Temperature	XX°C
	Firmware Version	xxxxxx
	Air Temperature	XX°C
	Backing Color	Displays the installed backing colors.
SProofer Setting	Press OK to start printing/alignment.	
Auto Take-up Reel Unit	xxxxxx	

## Network Setup Menu

 [“Network Setup” on page 122](#)

Menu item	Description	
IP Address Setting	Auto	-
	Panel	IP Address, Subnet Mask, Default Gateway
IPv6 Setting	On, Off	
IEEE802.1x Setting	On, Off	
HTTPS Redirect Setting	On, Off	
Print Status Sheet	Press OK to start printing.	
Restore Settings	Yes, No	



## Using the Control Panel Menu

### Preferences Menu

 [“Preferences” on page 123](#)

Menu item	Description
Language	Lists the supported languages.
Unit: Length	m, ft/in
Unit: Temperature	°C, °F
Sleep Mode	5 to 210 minutes
Power Off Timer	Off, 1 to 24 hours

### Administrator Menu

Items marked with an asterisk (\*) are only available when the optional hard disk unit is installed.

 [“Administrator Menu” on page 123](#)

Menu item	Description
Change Password	Enter a password.
Operational Control	Network Setup Password Required, No Password Required
Powerful Cleaning	All Nozzles Yes, No
	XX/XX (where XX indicates the ink color code) Yes, No
Date And Time	MM/DD/YY HH:MM
Time Zone	Enter the time difference between GMT and the current time zone.
Format HDD*	Non-Secure (Quick)
	Secure (Quick)
	Secure (Sanitizing)
Reset All Settings	Yes, No

Using the Control Panel Menu

# Menu Descriptions

## Maintenance

Item		Description
Nozzle Check		<p>Press the OK button to print a nozzle check pattern. Inspect the pattern visually and perform head cleaning if you detect faint or missing colors.</p> <p> <a href="#">"Checking for clogged nozzles" on page 126</a></p>
Head Cleaning		<p>Select the combination of ink colors for head cleaning, and the strength of the cleaning. Only use this menu when nozzles are clogged.</p> <p> <a href="#">"Cleaning the print head" on page 126</a></p> <p><b>Combination of ink colors to be cleaned</b> Check the ink colors with faint or missing segments in the check pattern, and then specify which nozzles to clean. The displayed items differ depending on the printer model and ink sets being used.</p> <ul style="list-style-type: none"> <li><input type="checkbox"/> If there are faint or missing segments in all colors: Select <b>All Nozzles</b>.</li> <li><input type="checkbox"/> If there are faint or missing segments in only a few colors: Select the specific ink colors you want to clean. You can select multiple items at the same time.</li> </ul> <p><b>Cleaning strength</b> Normally, select <b>Normal</b>. If nozzles are clogged even after performing <b>Normal</b> head cleaning several times, perform <b>Heavy</b> cleaning.</p>
All Nozzles	Normal	
	Heavy	
XX/XX	Normal	
	Heavy	
Head Alignment		<p>Perform print head alignment when setting up the printer for the first time, and after moving or transporting the printer. Perform print head alignment when the print results look grainy or out-of-focus. Normally, select <b>Auto</b>.</p> <p> <a href="#">"Adjusting print misalignments (Head Alignment)" on page 129</a></p> <p><b>Auto:</b> The printer reads adjustment patterns using the sensor while printing the patterns, and makes adjustments automatically.</p> <p><b>Manual:</b> The printer prints a pattern; inspect the pattern visually and enter the value you think appropriate. Use this if you cannot perform auto adjustment, or if you are not satisfied with the adjustment results when using <b>Auto</b>.</p>
Auto	Uni-D, Bi-D 2-color, Bi-D All Color, Bi-D #1 to #4	
Manual	Uni-D, Bi-D 2-color, Bi-D All Color	
Cutter Maintenance		Make settings for the printer's built-in cutter.
Adjust Cut Position	-3 to 3mm	You can fine tune the cut position when printing to roll paper with no margins in all directions. The cut position can be adjusted in increments of 0.2 mm.
Replace Cutter		<p>Moves the cutter to the replacement position so it can be replaced. Press the OK button to move the cutter to the replacement position. The paper must be removed before the cutter can be replaced. Remove the paper before proceeding.</p> <p> <a href="#">"Replacing the Cutter" on page 135</a></p>

## Using the Control Panel Menu

### Print Queues

This menu is only available when the optional hard disk unit is installed. When printing without using the printer driver included with the printer, the job names and estimated times in the following table may not be displayed correctly.

Item		Description
Print Queue		Lists the estimated start time and time needed to print the selected job.
XXXXXXXXXX (name of print queue)	Waiting Job Name User Estimated Start Time Estimated Print Time	The reason that printing cannot be performed is displayed in Remote Manager or LFP HDD Utility, and you can hold or cancel the job. <a href="#">☞ "Function Summary" on page 57</a>
Hold Queue		Displays the print settings for held jobs and the reason the job is held.
View Hold Queue		Jobs that are held because the job print settings differ from those currently selected for the printer can be printed as described below.
XXXXXXXXXX (name of hold queue)	Paused Job Name User Paper Type Source Size Reason For Hold	(1) Replace the paper and take whatever other steps may be necessary to ready the device for printing. (2) Select <b>Resume All Jobs</b> .
Resume All Jobs		Press the OK button to resume all held jobs currently in the queue.
Saved Job Queue		Shows the status of the selected stored job when it was last printed.
XXXXXXXXXX (name of stored job)	Stored Job Name User Paper Length Pages Paper Type Copies Source Size Estimated Print Time	If you press the ► button after confirmation, the <b>File Options</b> menu is displayed. <b>When Print File is selected</b> A screen is displayed where you can enter the number of copies. When you have entered the number of copies using the ▲/▼ buttons, the screen switches to Estimated Print Time. Press the OK button to start printing. <b>When Delete is selected</b> A confirmation screen is displayed. Press the OK button to delete the job.

## Using the Control Panel Menu

## Paper

\* Default setting

Item		Description
Select Paper Type	Photo Paper	Select the type of paper loaded. When loading commercially available paper, or when using customized paper settings, select the <b>Custom Paper</b> settings name.
	Proofing Paper	
	Fine Art Paper	
	Matte Paper	
	Plain Paper	
	Others	
	Custom Paper	
Custom Paper Setting		Register paper information when using commercially available paper or when using customized paper settings for genuine Epson paper. See the following table for details on the setting content.  "Custom Paper Setting" on page 117
Print Paper List		Press the OK button to print a list of custom paper settings.
Roll Paper Remaining		You can set the length for the currently loaded roll paper.
Remaining Setup	On	Select whether to display/record ( <b>On</b> ) or not to display/record ( <b>Off</b> ) the amount of remaining roll paper. If <b>On</b> is selected, you will be prompted to enter the length of the roll. When a length has been entered for the loaded roll paper, a barcode will automatically be printed on the roll stating the length remaining, the value selected for the roll remaining alert, and the paper type when the roll is removed.  The barcode is automatically read and settings adjusted the next time the paper is used, improving efficiency when multiple rolls of paper are used.
	Off*	
	Set Length	5.0 to 99.5
Set Alert Length	1 to 15 m (5*)	Displayed when <b>On</b> is selected for <b>Remaining Setup</b> . Set within a range from 1 to 15 m to display a warning when the amount of remaining roll paper drops below that limit. You can set in 1 m increments.
Roll Paper Setup		Only available when printing on roll paper.

## Using the Control Panel Menu

Item		Description
Auto Cut	On*	Choose <b>On</b> to automatically cut roll paper using the built-in cutter as each page is printed or <b>Off</b> to disable auto paper cutting. The setting selected with the printer driver takes priority when the printer driver is used.
	Off	
Page Line	On*	If <b>Auto Cut</b> is <b>Off</b> , you can choose to print ( <b>On</b> ) or not print ( <b>Off</b> ) cut lines on roll paper. Cut lines are not printed if <b>Auto Cut</b> is <b>On</b> or when cut sheets or poster board is used.  Note, however, that if the roll width selected with the computer is narrower than the paper loaded in the printer, cut lines will be printed regardless of the option selected for <b>Auto Cut</b> .  The setting selected with the printer driver takes priority when the printer driver is used.
	Off	
Roll Paper Margin	Normal*	When set to <b>Normal</b> , the top and bottom margins are 15 mm, and the left and right margins are 3 mm.
	Top15mm/ Bottom15mm	Except for <b>15mm</b> , the left and right margins for all other settings are 3 mm.
	Top35mm/ Bottom15mm	 <a href="#">"Printable area" on page 52</a>
	Top150mm/ Bottom15mm	
	3mm	
	15mm	
Refresh Margin	On*	If <b>On</b> is selected during borderless printing, the printer will automatically trim the leading edge to remove any ink stains that may have been left by the previous copy; to disable this feature, choose <b>Off</b> .
	Off	
Roll End Option	Continue	Select the action to perform for a roll after replacement: print the remaining data ( <b>Continue</b> ) / do not print ( <b>Stop Printing</b> ) / print again from the beginning ( <b>Reprint</b> ).  <b>Reprint</b> is only available when the optional hard disk unit is installed.
	Stop Printing*	
	Reprint	
Roll Paper Tension	1 to 5 (3*)	This setting is used if <b>Extra High</b> is set as one of the following settings: Paper menu - <b>Custom Paper Setting - Roll Paper Tension</b> , or <b>Paper Configuration - Roll Paper Back Tension</b> in the printer driver.  If wrinkles are formed on the paper during printing when the abovementioned <b>Roll Paper Back Tension</b> is <b>High</b> , set it to <b>Extra High</b> , and then configure the strength of the tension using this setting.  Higher values produce higher tension.

## Custom Paper Setting

Set each item in the following table for commercially available paper based on the characteristics of the paper. When customizing paper settings for genuine Epson paper, select the corresponding paper type from **Select Reference Paper**, and then enter your settings.

\* Default setting

### Using the Control Panel Menu

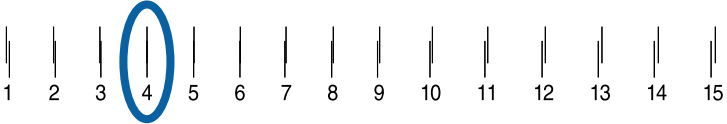
Item	Description	
XXXXXXXXXX	Displays the registered setting name.	
Select Reference Paper	Photo Paper, Proofing Paper, Fine Art Paper, Matte Paper, Plain Paper, Others, No Paper Selected	<p>You can select the media type that is the closest to the paper you are using. Select <b>No Paper Selected</b> if you do not want to specify a specific paper type.</p> <p>However, in Epson Color Calibration Utility you cannot use <b>No Paper Selected</b> as the <b>Select Reference Paper</b> setting. Make sure you select one of the other paper types.</p>
Platen Gap	Narrow Standard* Wide Wider Widest	<p>Select the platen gap, which is the distance between the print head and the paper. Normally, select <b>Standard</b>. Select a wider setting if print results are scratched or smudged. If, upon performing head alignment, you feel that it is still not completely aligned, select <b>Narrow</b>.</p>
Detect Paper Thickness	<p>Press the OK button to print a pattern to determine the thickness of the current paper. Select the pattern number with the least misalignment from the print results.</p> <p>In the following example image, "4" is the best choice.</p> 	

### Using the Control Panel Menu

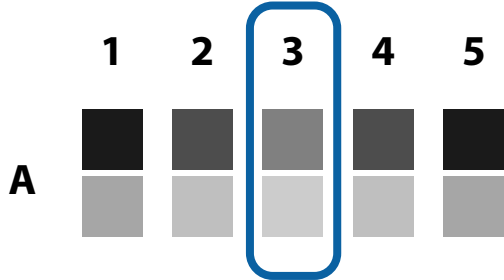
Item		Description
Paper Feed Adjust	Pattern	<p>Use this setting if you are unable to resolve banding issues (horizontal striped lines or uneven colors) in the standard print area (for cut sheets, the area excluding the 1 to 2 cm strip at the bottom of the paper) even after head cleaning or head alignment.</p> <p><b>Pattern selected</b> Press the OK button to print an adjustment pattern. Look for the adjustment pattern with the lightest colors from rows A to D, and enter the value.</p> <p>In the following example image, "3" is the best choice.</p> <div style="text-align: center;">  </div> <p>When the adjustment pattern has been printed, a screen where you can enter the number is displayed on the control panel. Use the ▼/▲ buttons to enter the numbers in order, and then press the OK button.</p> <p><b>Value selected</b> Choose an adjustment between -0.70 and +0.70%.</p> <p>Selecting too small a value causes dark bands; adjust the amount upward. Similarly, choosing too large a value causes white bands; adjust the amount downward.</p>
	Value	
Paper Suction	-4 to 0 (0*)	It is important to choose the appropriate amount of suction for the paper used in order to maintain the correct distance between the paper and the print head. Choosing too high a value for thin or soft paper will increase the distance between the paper and the print head, causing print quality to decline or preventing the paper feeding correctly. In such cases, you will need to lower the paper suction. The suction power is weakened when the parameter is lowered.
Drying Time Per Pass	0 to 10 seconds (0*)	<p>Select the time the print head pauses to allow drying after each pass. Choose from values between 0.0 and 10.0 seconds. Depending on the paper type, the ink may take a while to dry. If the ink blurs on the paper, set a longer time for drying the ink.</p> <p>Increasing the drying time increases the time needed to print.</p>
Roll Paper Tension	Standard*	Select <b>High</b> or <b>Extra High</b> if the paper wrinkles while printing on roll paper.
	High	If <b>Extra High</b> is set, the <b>Roll Paper Tension</b> setting in the Paper menu is enabled.
	Extra High	It is not necessary to set this option for cut sheets.
Remove Skew	On*	Select whether to enable (On) or disable (Off) paper skew reduction while printing on roll paper.
	Off	It is not necessary to set this option for cut sheets.
Setting Name		Enter a name of up to 22 characters for custom paper settings. Choose an easy-to-remember name for quick selection.
Restore Settings	Yes	Restore the selected custom paper settings to default values.
	No	

## Using the Control Panel Menu



## Printer Setup

\* Default setting

Item		Description
Platen Gap	Narrow	Select the Platen Gap, which is the distance between the print head and the paper. Normally, select <b>Standard</b> . Select a wider setting if print results are scratched or smudged. Select <b>Narrow</b> if you feel the print head is not completely aligned after performing head alignment.
	Standard*	
	Wide	
	Wider	
	Widest	
Paper Size Check	On*	Choose whether the printer automatically detects ( <b>On</b> ), or does not automatically detect ( <b>Off</b> ), the width of the media. We generally recommend to operate with this setting set to <b>On</b> . Try choosing <b>Off</b> if a paper setting error is displayed when the paper is correctly loaded. Note, however, that the printer may print outside the paper when <b>Off</b> is selected. If it prints beyond the edges of the paper, the inside of the printer becomes dirty with ink.
	Off	
Paper Skew Check	On*	If <b>On</b> is selected, an error will be displayed in the control panel and printing will stop if the paper is skewed; select <b>Off</b> to disable this feature. <b>On</b> is recommended in most circumstances as skewed paper may cause the printer to jam.
	Off	
Auto Nozzle Check		Set the timing that you want the printer to check the status of the nozzles, and if clogged nozzles are detected, set the number of times to perform auto cleaning. If the nozzles are not clogged, cleaning is not performed. <a href="#">🔗 "Automatically detecting clogged nozzles" on page 125</a>
Auto Cleaning Setting	Periodically*	Set the timing for performing an Auto Nozzle Check that will run before printing starts. <b>Periodically:</b> Checks at fixed intervals at a timing determined by the printer. <b>Every Job:</b> Checks at each job. <b>Off:</b> Checks only under specific conditions.
	Every Job	
	Off	
Auto Clean Max Repeat	1 to 3 (1*)	When clogged nozzles are detected, set the number of times to automatically repeat cleaning.
Timer Cleaning	XX hours	When the following operations are performed after the set time has passed from the time the last print was completed, cleaning is performed automatically. If the nozzles are not clogged, cleaning is not performed. <input type="checkbox"/> The printer is turned on. <input type="checkbox"/> The printer returns from sleep mode.
	Off*	
Print Nozzle Pattern	Every 10 pages*	Prints a nozzle check pattern at the top of the page after printing every page or every 10 pages.
	Every Page	You can check by viewing the pattern after printing, and determine if there are any problems in the print results before and after printing.
	Off	



## Using the Control Panel Menu

Item		Description
Auto Black Ink Change	On	<p>If the black ink type setting in the printer and the printer driver differ, it can be changed automatically to the selected type by the printer driver.</p> <p> <a href="#">"Changing the Type of Black Ink" on page 54</a></p> <p><b>On:</b> The black ink type is changed automatically, and printing is performed.</p> <p><b>Off:</b> An error message is displayed on the control panel's screen, and printing is paused.</p> <p> <a href="#">"What to do When a Message is Displayed" on page 139</a></p>
	Off*	
BK Ink Change Setting	Normal*	<p>When you select <b>Quick</b>, you can reduce the time necessary for changing the black ink type. However, when using the black ink immediately after changing, glossy sections may be uneven.</p> <p>Select <b>Normal</b> to maintain print quality immediately after changing the blank ink type.</p>
	Quick	
Calibration Setting	On*	<p>You can make settings whether to enable the calibration data for Epson Color Calibration Utility.</p> <p>For details on the calibration procedure and so on, see the software manual.</p>
	Off	
Store Held Job	On	<p>Only available when the optional hard disk unit is installed. If <b>On</b> is selected, print jobs that require a paper type, source, or output paper size (width) that differs from those currently selected with the printer will be saved as held jobs; select <b>Off</b> to disable this feature.</p> <p>If <b>Off</b> is selected, an error will be displayed and will printing will stop if the source selected for the print job does not match that selected with the printer.</p> <p>If <b>On</b> is selected, printing will not stop if an error occurs; instead, jobs with non-matching settings will be saved to the hard disk as held jobs. Held jobs can be printed from the Print Queue menu after the printer has been readied by, for example, loading the correct type of paper.</p> <p> <a href="#">"Function Summary" on page 57</a></p>
	Off*	
Restore Settings	Yes	<p>If <b>Yes</b> is selected, the <b>Printer Setup</b> is restored to default values.</p>
	No	

## Printer Status

Item	Description
Firmware Version	You can see the firmware version.
Option Status	Lists the optional accessories currently connected to the printer and available for use (Hard Disk Unit, SpectroProofer, Auto Take-up Reel Unit).
Print Status Sheet	Press the OK button to print a list of current printer settings. Choose this option to view settings at a glance.
Calibration Date	Displays the latest Epson Color Calibration Utility execution log. You can check details on operations and so on in Epson Color Calibration Utility.

## Using the Control Panel Menu

### Option Setup

Item	Description
SpectroProofer	You can check the current status of the SpectroProofer mounter installed on the printer, and initialize the settings.
SProofer Status	You can check the status of the SpectroProofer mounter.
Device Version:ILS30	Displays the version of the ILS30EP installed on the mounter.
Calibration Tile S/N	Displays the calibration tile serial number of the ILS30EP installed on the mounter.
Device Temperature	Displays the temperature of the ILS30EP installed on the mounter.
Firmware Version	Displays the version of the mounter.
Air Temperature	Displays the air temperature around the mounter.
Backing Color	Displays the backing colors installed in the mounter. If the color differs from the actual color, check the status of the backing and make sure it is installed correctly. For details on installing the SpectroProofer mounter, see the "Setup Guide" (booklet).
SProofer Setting	The printer automatically initializes the settings for the SpectroProofer mounter. For details on procedures for initializing settings and so on, see the "User's Guide" (PDF).
Auto Take-up Reel Unit	Displays the firmware version of the auto take-up reel unit installed on the printer.

### Network Setup

\* Default setting

Item	Description
IP Address Setting	Auto* Panel
	Select whether to use DHCP to set the IP address ( <b>Auto</b> ), or to set the address manually ( <b>Panel</b> ). Select <b>Panel</b> to enter the <b>IP Address</b> , <b>Subnet Mask</b> , and <b>Default Gateway</b> . Contact your system administrator for detailed information.
IPv6 Setting	On Off*
	Select whether to enable or disable the IPv6 function.
IEEE802.1x Setting	On Off*
	Select whether to enable or disable the IEEE802.1X function.
HTTPS Redirect Setting	On* Off
	Select whether to enable or disable the function to auto-direct HTTP to HTTPS.
Print Status Sheet	Press the OK button to print a list of the <b>Network Setup</b> . Use this information for a complete overview of network settings.

### Using the Control Panel Menu

Item		Description
Restore Settings	Yes	Select <b>Yes</b> to restore all <b>Network Setup</b> content to default values.
	No	

## Preferences

\* Default setting

Item		Description
Language	Japanese, English, French, Italian, German, Portuguese, Spanish, Dutch, Russian, Korean, Chinese	Select the language used on the control panel's screen.
Unit: Length	m*	Select the unit of length which is displayed on the control panel's screen or printed on the patterns.
	ft/in	
Unit: Temperature	°C*	Select the temperature units used in the control panel display.
	°F	
Sleep Mode	5 to 210 minutes (15*)	The printer will enter sleep mode if no errors have occurred, no print jobs have been received, and no actions are performed on the control panel for an extended period of time. This setting selects the amount of time until the printer enters sleep mode. <a href="#">☞ "Turning Off the Power Using Power Off Timer" on page 56</a>
Power Off Timer	Off	The printer turns off automatically when there are no errors, no print jobs being received, and no control panel or other operations are performed for eight hours.  The delay before the printer turns off can be selected from values between 1 and 24 hours in increments of 1 hour.  Choose <b>Off</b> to prevent the printer turning off automatically.
	1 to 24 hours (8*)	

## Administrator Menu

Selecting Administrator Menu displays a password prompt. No password is entered at shipment; press the OK button to proceed. If the administrator password has been changed, enter the administrator password.

\* Default setting

### Using the Control Panel Menu

Item	Description	
Change Password	<p>Enter an administrator password of up to 20 characters.</p> <p>Selecting Administrator Menu displays a password prompt. The Administrator Menu will only be displayed if the correct password is entered, preventing non-administrators from accidentally changing settings.</p> <p>Keep the password in a safe place.</p> <p>Should you forget the password, contact your dealer or Epson Support.</p>	
Operational Control	Choose whether the administrator password is required to access <b>Network Setup</b> from the control panel or Remote Manager.	
Network Setup	Password Required*	
	No Password Required	
Powerful Cleaning	All Nozzles	<p>Performs more powerful cleaning than <b>Head Cleaning</b> from the <b>Maintenance</b> menu. Check the ink colors with faint or missing segments in the check pattern, and then specify which nozzles to clean. The displayed items differ depending on the printer model and ink sets being used.</p> <ul style="list-style-type: none"> <li><input type="checkbox"/> If there are faint or missing segments in all colors: Select <b>All Nozzles</b>.</li> <li><input type="checkbox"/> If there are faint or missing segments in only a few colors: Select the specific ink colors you want to clean. You can select multiple items at the same time.</li> </ul>
	XX/XX	
Date And Time	MM/DD/YY HH:MM	Set the printer's built-in clock. The time provided by the clock is used when printing logs and status sheets.
Time Zone	<p>Enter the difference between the current time zone and GMT.</p> <p>The selected time zone is used in e-mail notifications sent by Remote Manager when an error occurs.</p>	
Format HDD	Non-Secure (Quick)	Only available when the optional hard disk unit is installed.
	Secure (Quick)	Formatting starts after you select the type of format and confirm the message displayed.
	Secure (Sanitizing)	<p>You can select from the following three types of formatting.</p> <ul style="list-style-type: none"> <li><input type="checkbox"/> <b>Non-Secure (Quick)</b>: Deletes file management information for data on the hard disk. Use this when you want to use the printer with a hard disk that has been used with other printers.</li> <li><input type="checkbox"/> <b>Secure (Quick)</b>: Overwrites the entire hard disk with a random character pattern. Erases data more securely than <b>Non-Secure (Quick)</b>. However, it is possible that data could be recovered by using a dedicated data recovery tool.</li> <li><input type="checkbox"/> <b>Secure (Sanitizing)</b>: Overwrites data with random 00/FF/ data, and then checks using an algorithm based on the U.S Department of Defense standard (DoD5220-22m). This option takes longer than the others to finish formatting, however it does provide the securest method of erasing data. Select this when you need to erase confidential data.</li> </ul>
Reset All Settings	Yes	Select <b>Yes</b> to restore defaults for all settings except the Date And Time, Language, and Unit: Length options in the Preferences menu.
	No	

## Maintenance

# Maintenance

## Print Head Maintenance

You need to perform print head maintenance if white lines appear in your print outs or if you notice the print quality has declined.

### Maintenance Operations

You can perform the following printer maintenance functions for maintaining the print head in good condition to ensure the best print quality. Carry out appropriate maintenance depending on the print results and situation.

#### Automatically detecting clogged nozzles

The printer has functions that allow it to automatically detect the position of clogged nozzles in the print head and perform cleaning without having to print a nozzle check pattern.

**Note:**

- This function does not guarantee 100% detection of clogged nozzles.
- A small amount of ink is consumed when detecting clogged nozzles.
- Ink is consumed when performing automatic cleaning.

You can set the following two items on the Printer Setup menu.

 [“Printer Setup” on page 120](#)

#### Auto Nozzle Check

When this is set to On, the status of the nozzles is checked at the following times. When clogged nozzles are detected, cleaning is performed automatically the number of times set on the control panel.

- When printing starts (periodically or every job)
- Before and after head cleaning

 **Important:**

Even if **Auto Cleaning Setting** from **Auto Nozzle Check** is set to **Off**, an auto nozzle check is always performed at the following times.

- After initial ink charging**  
An auto nozzle check is performed after ink charging to check the status of the nozzles. If clogged nozzles are detected, auto cleaning is performed once.
- Before changing the type of black ink**  
Since black inks cannot be changed correctly if nozzles are clogged, an auto nozzle check is performed. If nozzles are clogged, auto cleaning is performed (up to three times) until the nozzles are cleared regardless of the **Auto Clean Max Repeat** setting.

#### Timer Cleaning

After the set time has passed from the end of the previous print job, auto cleaning is performed when the following operations are performed. If the nozzles are not clogged, cleaning is not performed.

- The printer is turned on.
- The printer returns from sleep mode.

#### Checking for clogged nozzles using the printed check pattern

The following two methods are available.

##### On-Demand Nozzle Check Pattern

We recommend printing a nozzle check pattern and performing a visual inspection before printing when the printer has not been used for an extended period or when printing important print jobs. Visually inspect the printed pattern and clean the print head if you notice faint or missing areas.

 [“Checking for clogged nozzles” on page 126](#)

## Maintenance

### Print Nozzle Pattern function (for roll paper only)

A nozzle check pattern is printed at the top of the specified page (every page or every 10 pages). When printing a large reel of jobs, or when printing important print jobs, you can check that there are no clogged nozzles and determine if there are any problems in the print results before and after printing.

 [“Printer Setup” on page 120](#)

### Cleaning the print head

This function cleans the surface of the print head and clears clogged nozzles. Use this if faint or missing segments are detected in the check pattern.

 [“Cleaning the print head” on page 127](#)

### Adjusting print misalignments (Head Alignment)

This function adjusts the print misalignment. Use this if lines are misaligned or print results are grainy.

 [“Adjusting print misalignments \(Head Alignment\)” on page 126](#)

## Checking for clogged nozzles

Nozzle checks can be performing from a computer or using printer's control panel.

### From the computer

Explanations in this section use the Windows printer driver as an example.

Use Epson Printer Utility 4 for Mac OS X.

 [“Epson Printer Utility 4 Functions” on page 69](#)

- 1 Make sure that the roll paper or a cut sheet of A4 size or larger is loaded in the printer.

 [“Loading and Removing the Roll Paper” on page 28](#)

 [“Loading and Removing Cut Sheets” on page 34](#)

- 2 Choose a paper type that matches the paper in the printer.

 [“Checking and Setting the Paper Type” on page 37](#)

- 3 Click **Nozzle Check** from the **Utility** tab in the printer driver's **Properties** (or **Printing preferences**) screen.

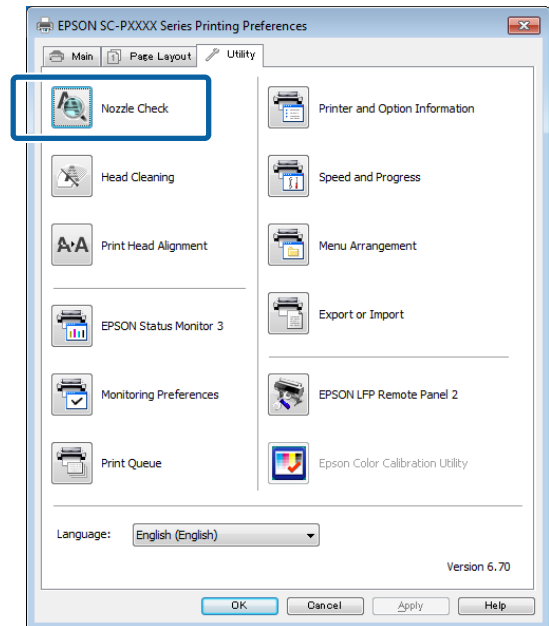

- 4 Click **Print**.

The nozzle check pattern is printed.

- 5 Check the nozzle check pattern.

If there is no problem: click **Finish**.

If there is a problem: click **Clean**.

After printing a nozzle check pattern, make sure that the nozzle check pattern printing is complete before printing your data or cleaning the print head.

### From the printer

Buttons that are used in the following settings

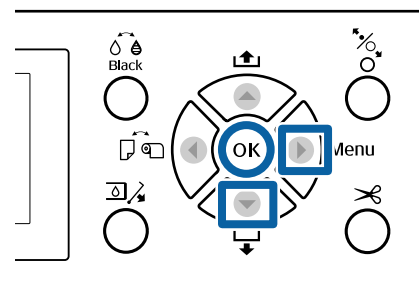

## Maintenance

- 1 Make sure that the roll paper or a cut sheet of A4 size or larger is loaded in the printer.

[“Loading and Removing the Roll Paper” on page 28](#)

[“Loading and Removing Cut Sheets” on page 34](#)

- 2 Choose a paper type that matches the paper in the printer.

[“Checking and Setting the Paper Type” on page 37](#)

- 3 Press the **▶** button to display the setup menu.

- 4 Confirm that **Maintenance** is highlighted, and then press the **▶** button twice.

A confirmation dialog will be displayed.

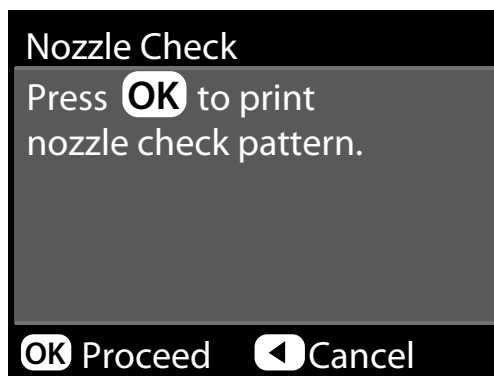

- 5 Press the OK button to print a check pattern.

Review the printed check pattern while referring to the following section.

### Example of clean nozzles



There are no gaps in the nozzle check pattern.

### Example of clogged nozzles



If any segments are missing in the nozzle check pattern, perform head cleaning.

[“Cleaning the print head” on page 127](#)

## Cleaning the print head

Although head cleaning can be performed from the computer or the printer, the cleaning procedures differ as explained below.

### From the computer

All nozzles are cleaned.

[“From the computer” on page 128](#)

### From the printer

You can clean all nozzles or select only those nozzles for which the printed nozzle check pattern indicates a problem. You can also select two levels of cleaning strength.

[“From the printer” on page 128](#)

## Notes on Head Cleaning

### Ink is consumed during head cleaning.

Clean the print head only if print quality declines; for example, if the printout is blurry or the color is incorrect or missing.

### When cleaning all nozzles, ink is consumed from all colors.

Even if you are using only black inks for black and white printing, color inks are also consumed.

### Prepare a new maintenance box if there is not enough empty space in the box.

If you repeat head cleaning several times in a short period, the ink in the maintenance box may become full soon as ink does not evaporate quickly from the maintenance box.

### Powerful Cleaning consumes much more ink than Head Cleaning in the Maintenance menu.

Check the remaining ink level in advance, and prepare a new ink cartridge before you start cleaning if the ink is low.

### If the nozzles are still clogged after performing Powerful Cleaning, turn off the printer and leave it overnight or longer.

When left for some time, the clogged ink may dissolve.

If the nozzles are still clogged, contact your dealer or Epson Support.

## Maintenance

### From the computer

Before starting this procedure, be sure to read the following:

 [“Notes on Head Cleaning” on page 127](#)

Explanations in this section use the Windows printer driver as an example.

Use Epson Printer Utility 4 for Mac OS X.

 [“Using Epson Printer Utility 4” on page 69](#)

- 1 Click **Head Cleaning** from the **Utility** tab in the printer driver's **Properties** (or **Printing preferences**) screen.

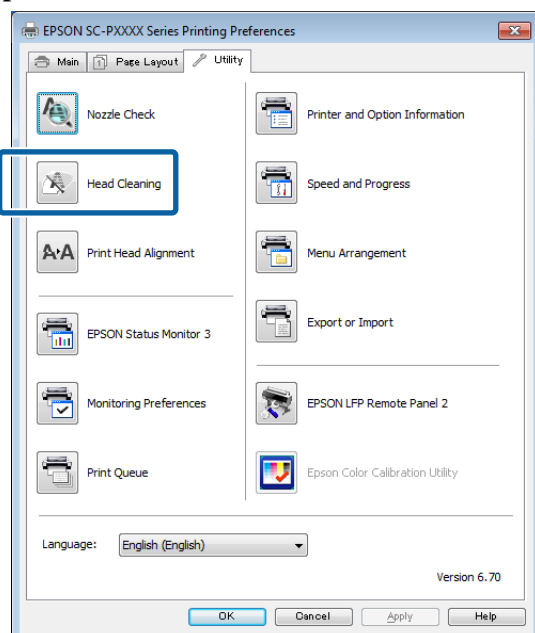

- 2 Click **Start**.  
Head cleaning starts and it takes about four minutes.

**Note:**

When **Auto Nozzle Check** is set to **On**, the nozzles are checked after head cleaning, and if clogging is detected, auto cleaning is performed. Depending on the status of the nozzles and the **Auto Clean Max Repeat** setting, this function can take up to 15 minutes.

- 3 Click **Print Nozzle Check Pattern**.  
Confirm the nozzle check pattern.

If you see any faint or missing segments in the nozzle check pattern, click **Cleaning**.

If you cannot clear the clogged nozzles even after repeating cleaning several times in succession, select **Heavy** from **Head Cleaning** on the printer's control panel.

 [“From the printer” on page 128](#)

### From the printer

Before starting this procedure, be sure to read the following:

 [“Notes on Head Cleaning” on page 127](#)

Buttons that are used in the following settings

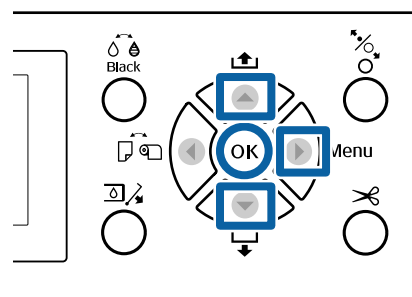

- 1 Press the **▶** button to display the setup menu.
- 2 Confirm that **Maintenance** is highlighted, and then press the **▶** button.  
The Maintenance menu will be displayed.
- 3 Press the **▼/▲** buttons to select **Head Cleaning**, and then press the **▶** button.
- 4 Select nozzle arrays for cleaning.  
Press the **▲/▼** buttons and select the color pairs with faint or missing segments in the check pattern.  
**If there are faint or missing segments in all colors**  
Select **All Nozzles**, and then press the **▶** button.  
**If there are faint or missing segments in part of the colors**  
Select the colors that need to be confirmed, and then press the **OK** button to confirm. You can select more than one at once. When you have finished selecting, press the **▶** button.



## Maintenance

- 5** Select the cleaning strength. To start, select **Normal**.

Press the ▲/▼ buttons to select the strength, and then press the OK button to start cleaning.

Head cleaning takes about 3 to 14 minutes.

**Note:**

*The more color pairs selected, the longer it takes to perform cleaning. Depending on the status of the nozzles and the **Auto Clean Max Repeat** setting, this function can take up to 24 minutes.*

A confirmation message is displayed when cleaning is complete.

- 6** To print a check pattern and check the status of the clogging, select **Nozzle Check**, and then press the OK button.

To exit without performing a nozzle check, select **Exit**, and then press the OK button.

If the nozzles are still clogged, repeat steps 1 to 5 several times. If the nozzles are still clogged after repeating the procedure several times in succession, repeat from step 1, and select **Heavy** in step 5.

If the nozzles are still clogged after performing **Heavy**, see the following section and perform **Powerful Cleaning**.

### Powerful Cleaning

Before starting this procedure, be sure to read the following:

 [“Notes on Head Cleaning” on page 127](#)

- 1** Press the ► button to display the setup menu.
- 2** Press the ▼/▲ buttons to select **Administrator Menu**, and then press the ► button.
- 3** Enter the administrator password, and then press the OK button.
- 4** Press the ▼/▲ buttons to select **Powerful Cleaning**, and then press the ► button.

- 5** Select the nozzle arrays for Powerful Cleaning.

Press the ▲/▼ buttons and select the color pairs with faint or missing segments in the check pattern.

**If there are faint or missing segments in all colors**

Select **All Nozzles**, and then press the ► button.

**If there are faint or missing segments in part of the colors**

Select the colors that need to be confirmed, and then press the OK button to confirm. You can select more than one at once. When you have finished selecting, press the ► button.

- 6** A confirmation dialog is displayed. Select **Yes**, and then press the OK button to start Powerful Cleaning.

Powerful Cleaning takes about 4 to 16 minutes.

**Note:**

*The more color pairs selected, the longer it takes to perform cleaning. Also, depending on the status of the nozzles, it can take up to about 27 minutes.*

When Powerful Cleaning is complete, you are returned to the screen displayed before cleaning was performed.

- 7** Print a check pattern, and inspect the results to determine if the problem has been resolved.

 [“From the printer” on page 126](#)

---

## Adjusting print misalignments (Head Alignment)

If lines are misaligned or print results are grainy, perform Head Alignment to adjust the print misalignment.

The print head fires ink when moving to the left and to the right while printing. Since there is a short distance (gap) between the paper surface and the print head, a print misalignment may occur due to the paper thickness, changes in temperature or humidity, and internal inertia while the print head moves.

Although Head Alignment can be performed from the computer or the printer, the alignment procedures differ as explained below.

## Maintenance

### From the computer

In auto adjustment (Bi-D 2-color), an adjustment pattern is printed on the loaded paper, read by the sensors, and the optimum adjustment value is registered to the printer. It takes about 6 minutes to complete the adjustments.

In most cases, head alignment can be performed successfully with just this operation. We normally recommend this method as this is the simplest method.

 [“From the computer” on page 130](#)

### From the printer

You can perform auto or manual adjustments. You can also select **Uni-D**, **Bi-D 2-color**, and **Bi-D All Color** adjustments from each menu.

#### Auto adjustment

The sensor reads the adjustment pattern printed on the paper, and automatically registers the optimum adjustment value to the printer. It takes about 3 to 10 minutes to complete the adjustments. The time required varies depending on the menu selected.

#### Manual adjustment

Visually check the adjustment patterns printed on the paper, and enter the optimal adjustment values. Use this if you cannot perform auto adjustment, or if you are not satisfied with the adjustment results when using Auto.

The following three menus are available for manual adjustment.

Item Name	Explanation
<b>Uni-D</b>	Adjusts differences in the print position for uni-directional printing for each color based on Light Cyan.
<b>Bi-D 2-color</b>	Adjusts differences in the print position for bi-directional printing for two colors, Light Cyan and Vivid Light Magenta.
<b>Bi-D All Color</b>	Adjusts differences in the print position for bi-directional printing for all colors.

It takes about 17 minutes to print an adjustment pattern. The time required varies depending on the menu selected.

 [“From the printer” on page 131](#)

## Notes on Head Alignment

### Adjustments are made depending on the paper loaded in the printer.

Make sure that the paper is loaded correctly, and that a **Select Paper Type** is selected.

 [“Loading and Removing the Roll Paper” on page 28](#)

 [“Loading and Removing Cut Sheets” on page 34](#)

When adjusting using commercially available paper, make sure you register the custom paper in advance.

 [“Before Printing on Commercially Available Paper” on page 177](#)

### Make sure that nozzles are not clogged.

If nozzles are clogged, adjustment may not be performed correctly. Print the check pattern, perform a visual inspection, and perform head cleaning if necessary.

 [“Checking for clogged nozzles” on page 126](#)

### Auto adjustment cannot be performed when using the following paper.

- Plain Paper
- Enhanced Matte Poster Board
- Transparent or colored paper

Perform manual adjustment when using these types of paper.

 [“From the printer” on page 131](#)

### When performing auto adjustment, make sure that no external light (direct sunlight) enters the printer.

Otherwise, the printer's sensors may not read the adjustment pattern correctly. If auto adjustment cannot be performed even after making sure no external light is entering the printer, perform manual adjustment.

 [“From the printer” on page 131](#)

## From the computer

Before starting this procedure, be sure to read the following:

 [“Notes on Head Alignment” on page 130](#)

## Maintenance

Explanations in this section use the Windows printer driver as an example.

Use Epson Printer Utility 4 for Mac OS X.

[“Using Epson Printer Utility 4” on page 69](#)

**1** Make sure that the roll paper or a cut sheet of A4 size or larger is loaded in the printer.

[“Loading and Removing the Roll Paper” on page 28](#)

[“Loading and Removing Cut Sheets” on page 34](#)

When adjusting using commercially available paper, make sure you register the Custom Paper in advance.

[“Before Printing on Commercially Available Paper” on page 177](#)

**2** Choose a paper type that matches the paper in the printer.

[“Checking and Setting the Paper Type” on page 37](#)

**3** Click **Print Head Alignment** from the Utility tab in the printer driver's **Properties** (or **Printing preferences**) screen.

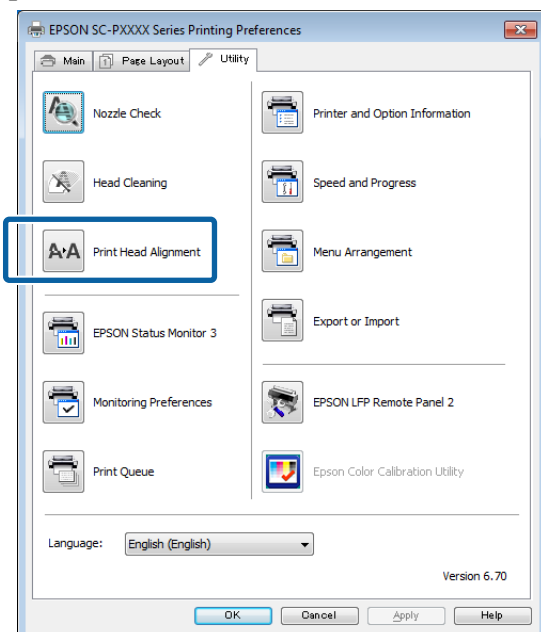

Follow the on-screen instructions.

The sensor reads the adjustment pattern while it is printing, and automatically registers the optimum adjustment value to the printer.

Check the adjustment results to confirm if graininess or misalignment recurs in the printed image.

If you are not satisfied with the adjustment results, perform manual adjustment from the printer.

[“From the printer” on page 131](#)

### From the printer

Before starting this procedure, be sure to read the following:

[“Notes on Head Alignment” on page 130](#)

Buttons that are used in the following settings

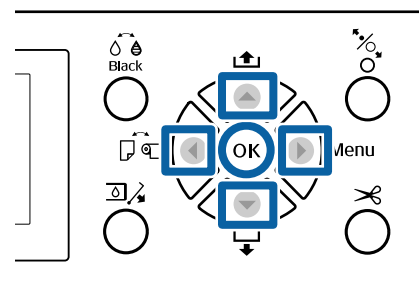

**1** Make sure that the roll paper or a cut sheet of A4 size or larger is loaded in the printer.

[“Loading and Removing the Roll Paper” on page 28](#)

[“Loading and Removing Cut Sheets” on page 34](#)

When adjusting using commercially available paper, make sure you register the Custom Paper in advance.

[“Before Printing on Commercially Available Paper” on page 177](#)

**2** Choose a paper type that matches the paper in the printer.

[“Checking and Setting the Paper Type” on page 37](#)

**3** Press the **▶** button to display the setup menu.

## Maintenance

- 4** Confirm that **Maintenance** is highlighted, and then press the ► button.

The Maintenance menu will be displayed.

- 5** Press the ▼/▲ buttons to select **Head Alignment**, and then press the ► button.

- 6** Select an adjustment item.

### When adjusting automatically

Press the ▼/▲ buttons to select **Auto**, and then press the ► button. Next, proceed to Step 7.

### When adjusting manually

Press the ▼/▲ buttons to select **Manual**, and then press the ► button. Next, proceed to Step 8.

- 7** Press the ▼/▲ buttons to select **Bi-D 2-color**, and then press the OK button.

The sensor reads the adjustment pattern while it is printing, and automatically registers the optimum adjustment value to the printer.

When adjustment is complete, you are returned to the screen displayed before head alignment was performed. Check the adjustment results to confirm if graininess or misalignment recurs in the printed image.

### If you are not satisfied with the adjustment results

Perform auto adjustment again from step 1, but select **Bi-D All Color** in step 7. If you are not satisfied with the results of **Bi-D All Color**, perform the same procedure for **Uni-D**.

If you want to make more detailed adjustments, perform **Bi-D #1**, **Bi-D #2**, **Bi-D #3**, or **Bi-D #4**. [#1] to [#4] displays the size of the ink dots. Since this differs depending on the printer driver settings when printing, perform [#1] to [#4] in order.

- 8** Press the ▼/▲ buttons to select **Bi-D 2-color**, and then press the OK button.

The adjustment pattern is printed on the loaded paper.

#### Note:

Multiple adjustment patterns are printed for cut sheets. Once printing the first sheet is complete, load the next sheet of paper.

- 9** Note the numbers of the patterns with the fewest white lines or in which the white lines are most evenly spaced.

This would be pattern "3" in the example shown in the illustration.

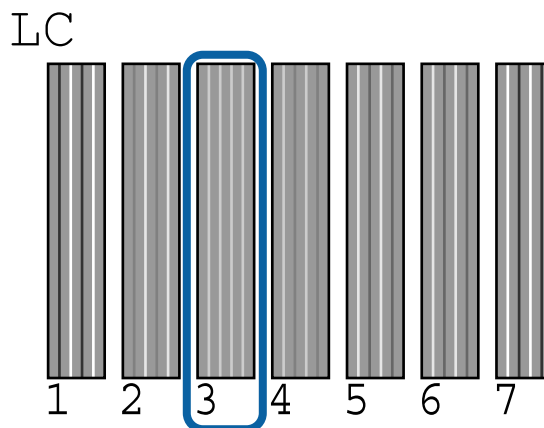

- 10** The screen to enter a numeric value is displayed. Enter the value for each check pattern number (such as #1) and ink color that you checked in step 9, and then press the OK button.

Enter a value for all pattern numbers and ink colors in order. After entering all values, you are returned to the screen displayed before head alignment was performed. Check the adjustment results to confirm if graininess or misalignment recurs in the printed image.

### If you are not satisfied with the adjustment results

Perform manual adjustment again from step 1, but select **Bi-D All Color** in step 8. If you are not satisfied with the results of **Bi-D All Color**, perform the same procedure for **Uni-D**.

## Maintenance

# Replacing Consumables

## Replacing Ink Cartridges

If one of the installed ink cartridges is expended, printing cannot be performed.

If an ink cartridge is expended while printing, you can continue printing after replacing the ink cartridge.

If you continue to use ink cartridges that are running low, you may need to replace the ink cartridge while printing. If you replace the ink cartridge while printing, colors may look different depending on how the ink dries. If you want to avoid issues such as this, we recommend replacing the cartridge before printing. You can still use the removed ink cartridge in the future until the ink cartridge is expended.

Supported ink cartridges  [“Options and Consumable Products” on page 156](#)

### How to replace

You can use the same procedure to replace all ink cartridges.

Note the following points when replacing ink. Otherwise, printer operations may not be performed correctly.

- Make sure the printer is turned on when replacing ink.
- Press the  button to open the ink cover.

#### Important:

*Epson recommends the use of genuine Epson ink cartridges. Epson cannot guarantee the quality or reliability of non-genuine ink. The use of non-genuine ink may cause damage that is not covered by Epson's warranties, and under certain circumstances, may cause erratic printer behavior. Information about non-genuine ink levels may not be displayed, and use of non-genuine ink is recorded for possible use in service support.*

- 1 Make sure the printer is on.

- 2 Press the  button on the control panel.

#### Note:

*The  button is disabled while printing or cleaning.*

- 3 Select the cover for the ink cartridge you want to replace, and then press the OK button.

The ink cover lock is released, and the cover opens by about 5 mm.

- 4 Open the ink cover.

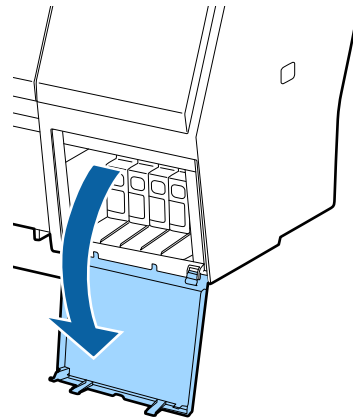

#### Important:

*Do not force open the ink cartridge cover until the lock is released.*

- 5 Push back the ink cartridge that you want to replace.

When you hear a click, the ink cartridge will pop out a little.

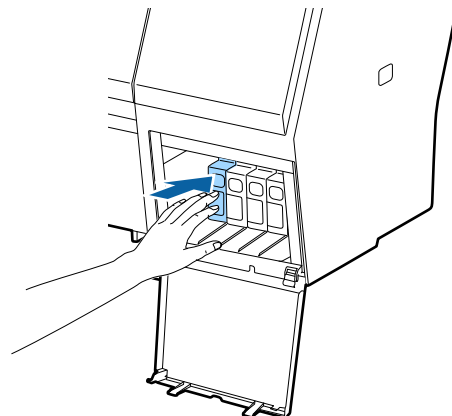

## Maintenance

- 6** Pull out the ink cartridge.

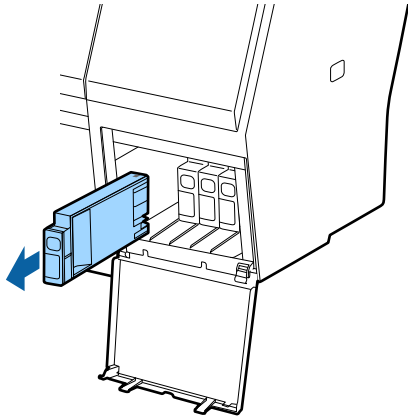

**!** **Important:**

Removed ink cartridges may have ink around the ink supply port, so be careful not to get any ink on the surrounding area when removing the cartridges.

- 7** Remove the new ink cartridge from the bag. Shake the ink cartridge for 5 seconds 15 times horizontally in approximately 5 cm movements as shown in the illustration.

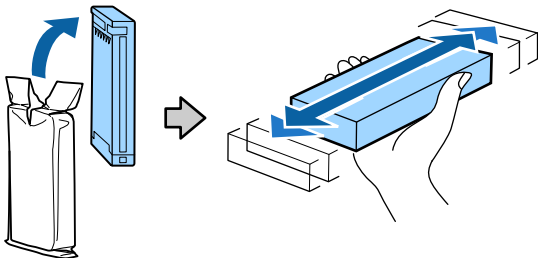

**!** **Important:**

Do not touch the IC chips on the ink cartridges. You may not be able to print properly.

- 8** With the ▲ mark on the ink cartridge facing up, press it in until you hear it click.

Match the color of the ink cartridge to the color of the label on the back of the ink cover.

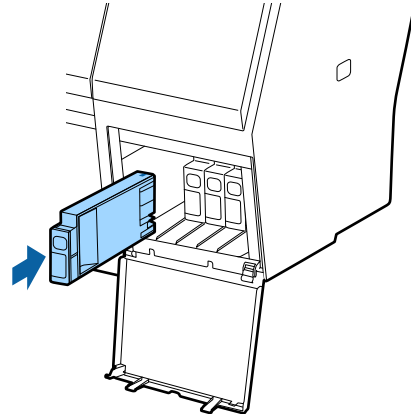

**!** **Important:**

Install all ink cartridges into each slot. You cannot print if any of the slots are empty.

- 9** Close the ink cover.

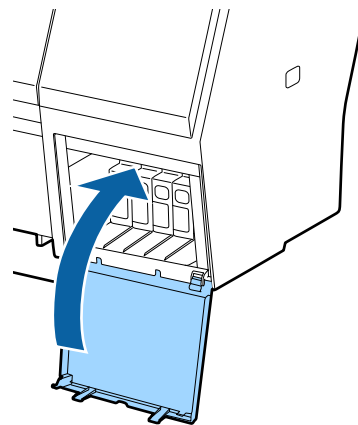

## Replacing Maintenance Boxes

If the message **No Enough Space** is displayed, replace the specified Maintenance Box.

Supported Maintenance Boxes

 [“Options and Consumable Products” on page 156](#)

## Maintenance

### **!** Important:

Do not reuse maintenance boxes that have been removed and left out in the open for a long period of time. The ink on the inside will be dry and hard and will be unable to absorb enough ink.

## How to replace

The following shows the number of maintenance boxes and the installation positions.

SC-P9000 Series/SC-P8000 Series: 2 (left and right)

SC-P7000 Series/SC-P6000 Series: 1 (right only)

Replace the Maintenance Box on the side with the **No Enough Space** message displayed. The replacement procedure is the same for both sides. When you need to replace both sides, repeat Steps 2 to 5.

### **!** Important:

Do not replace the Maintenance Box when the printer is turned on. Waste ink may leak.

- 1 Turn off the printer.
- 2 Remove the new maintenance box from the package.
- 3 Remove the maintenance box without tilting it.

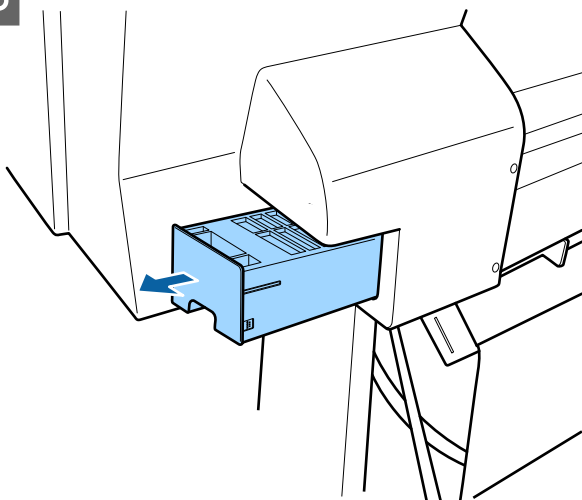

- 4 Place the used maintenance box in the clear bag included with your new maintenance box, and make sure that the zipper is closed tight.

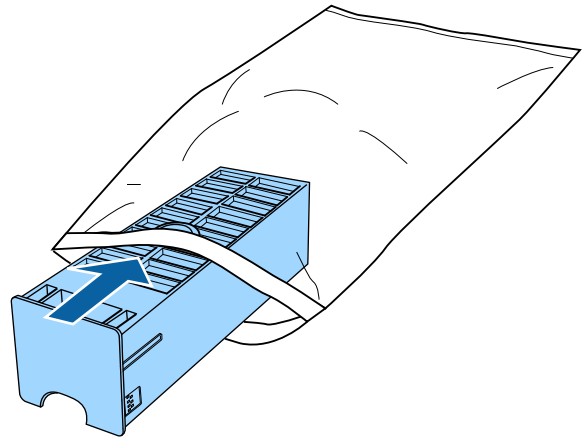

- 5 Insert the new maintenance box.

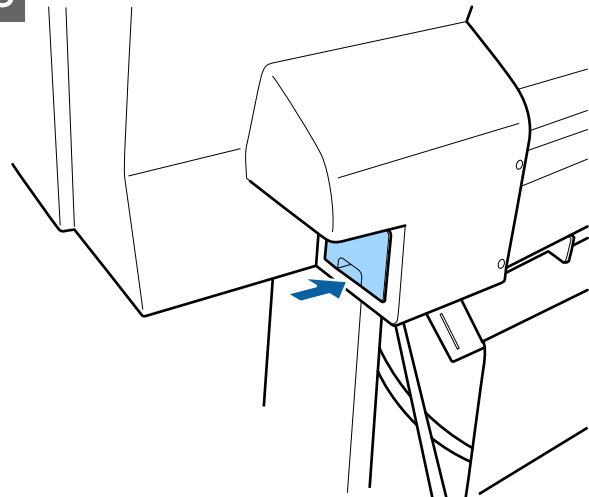

### **!** Important:

Do not touch the IC chip on the maintenance box. Doing so may prevent normal operation and printing.

## Replacing the Cutter

Replace the cutter when it is not cutting paper cleanly.

Supported cutter

 [“Options and Consumable Products” on page 156](#)

Use a cross-head screwdriver to replace the cutter. Make sure you have a cross-head screwdriver with you before replacing the cutter.

## Maintenance

**! Important:**

Take care not to damage the cutter blade. Dropping it or knocking it against hard objects may chip the blade.



**When the SpectroProofer mounter (option) is installed**

You cannot open the cutter replacement cover when the SpectroProofer mounter is installed. Remove the SpectroProofer mounter before replacing the cutter, and then reinstall it afterwards. When removing, see the manual supplied with the mounter, and then follow the procedure in reverse to reinstall it.

 "SpectroProofer Mounter 24"/44" Setup Guide" (booklet)

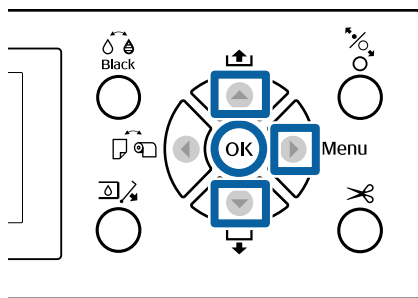
Buttons that are used in the following settings



- 1** Remove any paper from the printer.  
 ["Removing Roll Paper" on page 32](#)  
 ["Removing Cut Sheets" on page 36](#)
- 2** Press the ► button to display the setup menu.
- 3** Confirm that **Maintenance** is highlighted, and then press the ► button.  
 The Maintenance menu will be displayed.
- 4** Press the ▲/▼ buttons to select **Cutter Maintenance**, and then press the ► button.
- 5** Press the ▲/▼ buttons to select **Replace Cutter** and press the ► button.  
 A confirmation dialog will be displayed.
- 6** Press the OK button to move the cutter to the replacement position.

- 7** Press down the knob on the cutter replacement cover, and pull it down and towards you to remove.

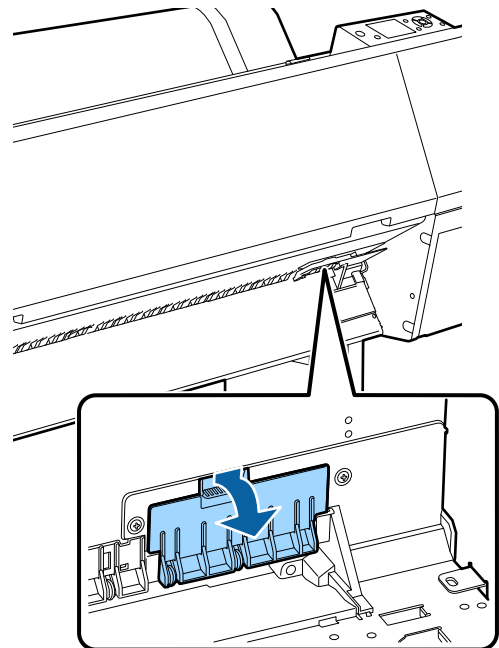

- 8** Loosen the screw that secures the cutter with a cross-head screwdriver.

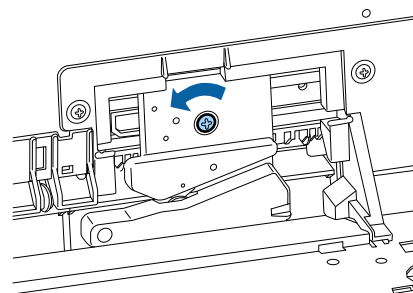

- 9** Remove the old cutter from the printer.

**! Caution:**

Do not store the cutter within the reach of children. The cutter's blade could cause an injury. Pay careful attention when replacing the cutter.

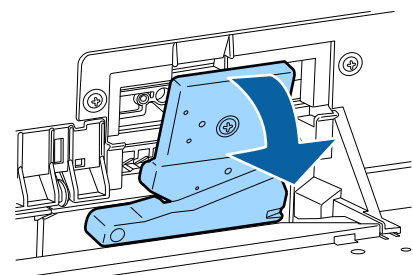



**Maintenance**

- 10** Install the new cutter.  
Insert a screw into the cutter side of the hole on the printer.

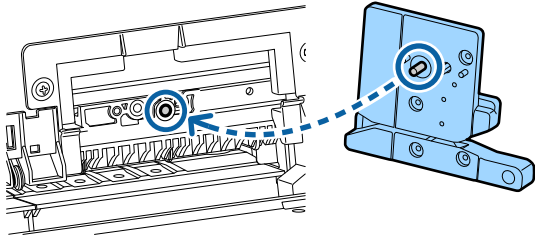

- 11** Tighten the screw with a cross-head screwdriver to secure the cutter.

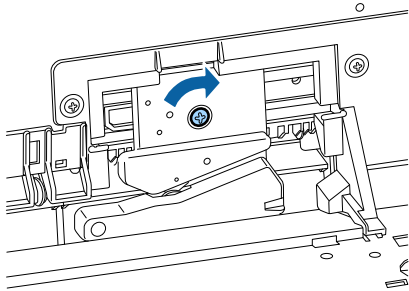

**! Important:**

*Screw the cutter firmly, otherwise the cut position may be slightly shifted or skewed.*

- 12** Insert the base of the cutter replacement cover in the correct place, and push in the top part.  
Push until you hear it click into place.

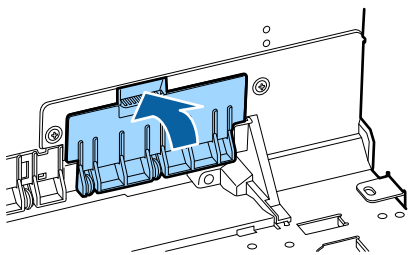

- 13** After replacing the cutter, press the OK button.  
The cutter will return to its original position.  
Cutter replacement is complete when the screen on the control panel returns to the screen displayed before you started replacement.

## Cleaning the Printer

To keep your printer in optimum operating condition, clean it regularly (about once a month).

### Cleaning the outside

- 1** Remove any paper from the printer.
- 2** Make sure the printer is turned off and the screen has turned off, and then unplug the power cable from the outlet.
- 3** Use a soft, clean cloth to carefully remove any dust or dirt.

If the printer is particularly dirty, dampen the cloth with water containing a small amount of neutral detergent, and then firmly wring the cloth dry before using it to wipe the printer's surface. Next, use a dry cloth to wipe away any remaining moisture.

**! Important:**

*Never use benzene, thinners, or alcohol to clean the printer. They could cause discoloration and deformities.*

### Cleaning the inside

Clean the pressure rollers if prints are smudged or soiled.

Ink and particles of paper adhering to the platen should be removed, as they may otherwise soil the paper.

**! Important:**

*Failure to remove dust and particles of paper from the platen could result in clogged nozzles or damage to the print head.*

### Cleaning the roller

Follow the steps below to clean the roller by feeding plain paper.

## Maintenance

- 1 Turn on the printer, and load it with widest available roll paper.  
 ☞ [“Loading and Removing the Roll Paper” on page 28](#)
- 2 Press the ▼ button.  
 Paper is fed while the ▼ button is pressed. If the paper is not soiled, cleaning is complete.

Cut the paper after cleaning is done.

☞ [“Manual cut method” on page 32](#)

### Cleaning Inside the Printer

- 1 Make sure the printer is turned off and the screen has turned off, and then unplug the power cable from the outlet.
- 2 Leave the printer for a minute.
- 3 Open the front cover and use a soft, clean cloth to carefully clean away any dust or dirt inside the printer.

Carefully wipe the light blue areas (a) shown in the following illustration. So as not to smear dirt, wipe in the direction indicated by the arrow in the illustration. If the printer is particularly dirty (when the back of the paper is soiled while printing), dampen the cloth with water containing a small amount of neutral detergent, and then firmly wring the cloth dry before using it to wipe the printer's surface. Then, wipe the inside of the printer with a dry, soft cloth.

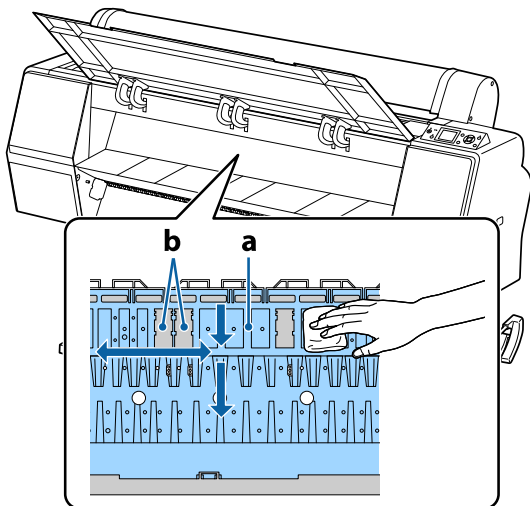

#### **!** Important:

- ❑ Be sure not to touch the roller or the ink absorbing areas (b, shown in gray) during cleaning; otherwise, prints may be soiled.
- ❑ Be careful not to touch the ink tubes inside the printer, otherwise, the printer may be damaged.

- 4 If any paper particles (that looks like white powder) accumulates on the platen, use something like a cocktail stick to push it in.

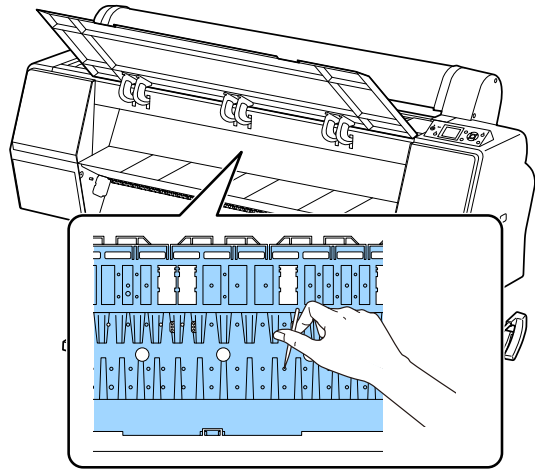

- 5 After cleaning, close the front cover.

## Problem Solver









# Problem Solver

## What to do When a Message is Displayed









If the printer displays one of the messages shown below, refer to the solution listed and take the necessary steps.

Messages	What to do
Ink Cartridge Error Ink cartridge cannot be recognized. Insert again or replace ink cartridge.	<ul style="list-style-type: none"> <li><input type="checkbox"/> Remove and reinsert the ink cartridge. If the message persists, insert a new ink cartridge (do not reinstall the cartridge that caused the error). <a href="#">☞ "How to replace" on page 133</a></li> <li><input type="checkbox"/> Condensation may occur in the ink cartridge. Leave it at room temperature for at least four hours before installing the ink cartridge. <a href="#">☞ "Notes on handling ink cartridges" on page 19</a></li> </ul>
Ink Cartridge Error Ink cartridge cannot be detected. Insert again or replace ink cartridge.	
Ink Cartridge Error Please install the correct ink cartridge.	<p>Insert a genuine Epson ink cartridge approved for use in the printer.</p> <p><a href="#">☞ "Options and Consumable Products" on page 156</a></p> <p><a href="#">☞ "Replacing Ink Cartridges" on page 133</a></p>
Ink Low	<p>The ink is low. Ready a new ink cartridge.</p> <p><a href="#">☞ "Options and Consumable Products" on page 156</a></p>
Cleaning Error Automatic head cleaning failed. Retry?	<p>Clogged nozzles are not cleared even after performing Auto Cleaning the set number of times. To perform Auto Cleaning again, select <b>Yes</b>. To finish, select <b>No</b>.</p> <p><a href="#">☞ "Automatically detecting clogged nozzles" on page 125</a></p>
Paper Load Error No paper detected.	<ul style="list-style-type: none"> <li><input type="checkbox"/> Roll Paper Remove and then reload the roll paper. Before you reset the paper, cut the edge of the roll paper straight horizontally. Cut off any jagged or folded sections. If there is a problem with the edge, a paper load error occurs again. <a href="#">☞ "Loading and Removing the Roll Paper" on page 28</a></li> <li><input type="checkbox"/> Poster Board Remove and then reload the poster board. Load the paper straight so that it is not skewed. <a href="#">☞ "Loading Cut Sheets A3 Size or Larger and Poster Board" on page 34</a></li> </ul>
Paper Eject Error Could not eject paper.	<p>Press the OK button to clear the error. If any paper remains inside the printer, remove it.</p> <p><a href="#">☞ "Roll paper jam" on page 151</a></p> <p><a href="#">☞ "Cut sheets jam" on page 152</a></p> <p>If you select <b>Cut Sheet</b> from the Paper Source menu even if roll paper is loaded, change the setting to <b>Roll Paper</b>, and then reload the paper.</p> <p><a href="#">☞ "Loading and Removing the Roll Paper" on page 28</a></p>
Paper Cut Error Remove uncut paper.	<p>After pressing the OK button, pull out the paper and cut along the line of the failed cut using scissors or a commercially available cutter.</p> <p>Pull the edge of the paper straight outside the printer.</p>

## Problem Solver

Messages	What to do
<p>Paper Size Error Loaded paper is not supported size.</p>	<p>The loaded paper width is not supported. Press the OK button and remove the paper.</p> <p>Paper for use in the printer must be at least 254 mm wide. Use paper that is at least 254 mm wide.</p> <p>Should this message be displayed with paper of a width that can be used in the printer, you may be able to print if you select <b>Off</b> for <b>Paper Size Check</b> in the Printer Setup menu.</p> <p> <a href="#">"Printer Setup" on page 120</a></p>
<p>Paper Sensor Error Loaded paper or print out has a problem. Refer to manual for details.</p>	<p>Press the  button to clear the error from the control panel.</p> <p>If this error is displayed when performing automatic head alignment, check the following items.</p> <ul style="list-style-type: none"> <li><input type="checkbox"/> Does the paper support auto head alignment? Head alignment is not available with transparent or colored media, tracing paper, paper not supported by the auto head alignment function, or paper that is 1.0 mm or more thick.  <a href="#">"Notes on Head Alignment" on page 130</a></li> <li><input type="checkbox"/> Are outside light sources interfering with the process? If the printer is exposed to direct sunlight or another light source that causes optical interference, shade the printer from these sources.</li> <li><input type="checkbox"/> Are the default values selected for <b>Platen Gap</b>? Restore the item to its default value.</li> <li><input type="checkbox"/> Are some print head nozzles clogged? Perform head cleaning.  <a href="#">"Cleaning the print head" on page 126</a></li> </ul> <p>If this error is displayed in circumstances other than those listed above, check that the printer supports the current paper.</p> <p> <a href="#">"Supported Media" on page 159</a></p>
<p>F/W Install Error Firmware update failed. Restart the printer.</p>	<p>Turn the printer off, wait for a few minutes, and then turn on the printer again.</p> <p>Update the firmware again.</p> <p>If this message appears on the LCD panel again, contact your dealer or Epson Support.</p>
<p>Command Error Check driver settings.</p>	<p>Press the  button and select <b>Job Cancel</b> to stop printing. Confirm that the printer driver you are using supports this printer.</p>
<p>Reel Unit Error Check Auto Take-up Reel Unit and restart printer.</p>	<p>Turn the printer off, wait for a few minutes, and then turn on the printer again.</p> <p>If this message appears on the LCD panel again, contact your dealer or Epson Support.</p>
<p>Reel Unit Error Connect Auto Take-up Reel Unit cable and restart printer.</p>	<p>After reconnecting the cable connecting the auto take-up reel unit to the printer, turn the printer off and then on again.</p> <p> The <i>Setup Guide</i> supplied with the optional auto take-up reel unit.</p>
<p>Reel Unit Disconnected Auto Take-up reel unit is disconnected. Do you continue?</p>	<p>The auto take-up reel unit is not connected. After reconnecting the cable connecting the auto take-up reel unit to the printer, select <b>No</b> to turn the printer off. Turn the printer again after a short pause.</p> <p> The <i>Setup Guide</i> supplied with the optional auto take-up reel unit.</p> <p>To continue printing without using the auto take-up reel unit, select <b>Yes</b>.</p>

## Problem Solver

Messages	What to do
<p>Take-Up Error Is anything obstructing the take-up reel sensor system?</p>	<p>After checking the take-up reel unit sensor and removing any obstructions, press the OK button.</p> <p>If there is loose paper around the take-up reel unit roll core, set the Auto switch to Off and keep the Manual switch pressed in the take-up direction to remove the slack. After confirming that the paper is correctly attached, return the Auto switch to its original position and press the OK button.</p> <p> <a href="#">"Using the Auto Take-up Reel Unit (SC-P9000 Series/SC-P8000 Series Only)" on page 43</a></p>
<p>HDD Error HDD used for another printer needs to be formatted. Continue?</p>	<p>Optional hard disk units that have been installed on other devices must be formatted after being transferred to this printer. The disk can not be used until it is formatted. To format the disk, use the Administrator Menu menu in the control panel.</p> <p> <a href="#">"Administrator Menu" on page 123</a></p>
<p>Storage Error Check if hard disk unit is correctly installed.</p>	<p>Press the  button and select <b>Job Cancel</b> to stop printing. Remove and reinstall the hard disk unit.</p> <p>If this message appears on the LCD panel again, contact your dealer or Epson Support.</p> <p>When you are printing via the printer driver included with the printer, you can print regardless of the hard disk status when you select <b>Print only in Hard Disk Unit Settings</b>.</p> <p> <a href="#">"Saving Print Jobs" on page 58</a></p>
<p>Data Size Error Data size of print job is too large. Check on print job.</p>	<p>The optional hard disk unit can store print jobs up to 100 GB in size. To print larger jobs, select <b>Print only</b> from <b>Hard Disk Unit Settings</b> in printer driver; alternatively, make sure that print jobs are less than 100 GB in size.</p> <p> <a href="#">"Saving Print Jobs" on page 58</a></p>
<p>HDD Store Error Hard disk does not have enough space. See documentation for how to delete stored print jobs.</p>	<p>Unwanted jobs can be deleted from Remote Manager or the LFP HDD Utility.</p> <p> <a href="#">"Print Job Management" on page 57</a></p>
<p>HDD Boot Error Hard disk error. Hard disk cannot be used.</p>	<p>Press the OK button to clear the error from the control panel. When you are printing via the printer driver included with the printer, you can print regardless of the hard disk status when you select <b>Print only in Hard Disk Unit Settings</b>.</p> <p> <a href="#">"Saving Print Jobs" on page 58</a></p> <p>If this message appears on the LCD panel again, contact your dealer or Epson Support.</p>
<p>Held Jobs Limit Held job queue full.</p>	<p>The number of held jobs has reached 200.</p> <p>Press the OK button and select <b>Resume All Jobs</b>.</p> <p> <a href="#">"Function Summary" on page 57</a></p>
<p>Checking hard disk</p>	<p>Data saved to the optional hard disk unit is being checked. If the results of the check indicate that data restoration is necessary, the restoration is carried out next. Restoration may take up to 20 minutes.</p> <p>If the restoration ends, the start completes.</p> <p>If it was not possible to restore the data, the format menu of the hard disk appears. If the hard disk is formatted, the hard disk can be used again. If you exit the menu without formatting the hard disk, only printing that does not use the hard disk is possible.</p>

## Problem Solver

Messages	What to do
SP Connection Error See manual and reconnect cables of SpectroProofer Mounter to printer.	The optional SpectroProofer mounter (from here on, mounter) is not installed on the printer correctly. Turn off the printer, and then reconnect the cables of the SpectroProofer mounter correctly. Turn on the printer again after a short pause.  See the manual supplied with the mounter for more information on connecting cables.
SProofer Disconnected SpectroProofer Mounter is not recognized. Continue?	The mounter is not connected to the printer correctly. Connect the cables of the mounter correctly, and then select <b>No</b> to turn off the printer. Turn on the printer again after a short pause.  See the manual supplied with the mounter for more information on connecting cables. If you do not want to use the mounter, select <b>Yes</b> .
ILS30EP Error See manual and reconnect ILS30EP to SpectroProofer Mounter. Turn printer off and on again.	The optional color measurement device ILS30EP (from here on, ILS30EP) is not installed on the mounter correctly. Turn off the printer, and then reconnect the cables of the ILS30EP correctly. Turn on the printer again after a short pause.  See the manual supplied with the ILS30EP for more information on connecting cables.
ILS30EP Disconnected ILS30EP is not recognized. Continue?	The ILS30EP is not connected to the printer correctly. Connect the cables of the ILS30EP correctly, and then select <b>No</b> to turn off the printer. Turn on the printer again after a short pause.  See the manual supplied with the ILS30EP for more information on connecting cables. If you do not want to use the mounter, select <b>Yes</b> .
SpectroProofer Error See documentation for how to solve the problem. NN (where NN is the error number)	The solution depends on the error number. See the following table.   <a href="#">"SpectroProofer Error" on page 142</a>

## SpectroProofer Error



If **SpectroProofer Error** is displayed, see the two numbers at the end of the error number for the solution. See the manual supplied with the mounter for more information on removing, cleaning, and installing, the mounter.

If this message appears on the LCD panel again, contact your dealer or Epson Support.

 See ["Where To Get Help" on page 186](#)

Error Number	What to do
01	The mounter is not installed correctly. Turn off the printer, remove the mounter, and then install it again.

### Problem Solver

Error Number	What to do
13, 15	<p>Check the following points.</p> <ul style="list-style-type: none"> <li><input type="checkbox"/> Is there an error in the backing? Remove the mounter and check the backing condition. If it is not installed correctly, install it again. Remove any packing material or foreign substances between the media holding plates and the backing.</li> <li><input type="checkbox"/> Are there any errors in the carriage moving area? Remove the mounter and check the base and the interior. Remove any packing material or foreign substances.</li> <li><input type="checkbox"/> Are there any errors in the calibration tile holder? Remove the mounter and check the status of the calibration tile holder. If it is not installed correctly, install it again.</li> <li><input type="checkbox"/> Are you using paper that does not meet the required specifications? Do not use paper that is not supported by the mounter.  <a href="#">"Supported Media" on page 159</a></li> <li><input type="checkbox"/> Is the printer being used in an environment that does not meet the required specifications? Make sure you use the printer, mounter, and paper within the required specifications. See the manual supplied with the accessories for more information on the recommended environmental conditions for the mounter and paper. Recommended environment for the printer  <a href="#">"Specifications Table" on page 183</a></li> </ul>
80	<p>Check the following points.</p> <ul style="list-style-type: none"> <li><input type="checkbox"/> Do the numbers on the ILS30EP and the calibration tile label match? Remove the mounter and check the ILS30EP and the label of the calibration tile. If you have multiple ILS30EP, make sure you install the one that matches the number on the calibration tile.</li> <li><input type="checkbox"/> Is the lens of the ILS30EP or the calibration tile soiled? See the manual supplied with the mounter to clean the parts.</li> </ul>
For numbers other than the above	<p>Make a note of the number displayed and contact customer support services for assistance. If customer support for your area is not listed below, contact the dealer where you purchased your product.</p> <p> See <a href="#">"Where To Get Help" on page 186</a></p>

## When a Maintenance Call/Service Call Occurs

Error messages	What to do
<p>Maintenance Request Replace Part Soon/Replace Part Now XXXXXXXX</p>	<p>A part used in the printer is nearing the end of its service life.</p> <p>Contact your dealer or Epson Support and tell them the maintenance request code.</p> <p>You cannot clear the maintenance request until the part is replaced. A service call occurs if you continue to use the printer.</p>

**Problem Solver**

<b>Error messages</b>	<b>What to do</b>
<p>Call For Service                      XXXX Error XXXX                      Power off and then on. If this doesn't work, note the code and call for service.</p>	<p>A call for service occurs when:</p> <ul style="list-style-type: none"> <li><input type="checkbox"/> The power cable is not connected securely</li> <li><input type="checkbox"/> An error that cannot be cleared occurs</li> </ul> <p>When a call for service has occurred, the printer automatically stops printing. Turn off the printer, disconnect the power cable from the outlet and from the AC inlet on the printer, and then reconnect. Turn on the printer again multiple times.</p> <p>If the same call for service is displayed on the LCD panel, contact your dealer or EpsonSupport for assistance. Tell them the call for service code is "XXXX".</p>



**Problem Solver**

# Troubleshooting

## You cannot print (because the printer does not work)

### The printer does not turn on.

■ **Is the power cable plugged into the electrical outlet or the printer?**  
 Make sure the power cable is securely plugged into the printer.

■ **Is there a problem with the power outlet?**  
 Make sure your outlet works by connecting the power cable for another electric product.

### The printer turns off automatically.

■ **Is Power Off Timer enabled?**  
 To prevent the printer turning off automatically, select **Off**.  
 ↗ "Preferences" on page 123

### The printer driver is not installed properly (Windows).

■ **Is the icon for this printer displayed in the Devices and Printers/Printer/Printers and Faxes folder?**

- Yes  
 The printer driver is installed. See "The printer is not connected correctly to the computer" on the next page.
- No  
 The printer driver is not installed. Install the printer driver.

■ **Does the printer port setting match the printer connection port?**  
 Check the printer port.

Click the **Port** tab in the printer Properties dialog and check the option selected for **Print to following port(s)**.

- USB:USBxxx (x stands for the port number) for the USB connection
- Network: The correct IP address for the network connection

If it is not indicated, the printer driver is not installed correctly. Delete and reinstall the printer driver.  
 ↗ "Uninstalling Software" on page 27

### The printer driver is not installed properly (Mac OS X).

■ **Is the printer added to the printer list?**  
 Click the Apple menu - **System Preferences** - **Printers & Scanners** (or **Print & Fax**).  
 If the printer name is not displayed, add the printer.

### The printer is not communicating with the computer.

■ **Is the cable plugged in properly?**  
 Confirm that the interface cable is securely connected to both the printer port and the computer. Also, make sure the cable is not broken nor bent. If you have a spare cable, try connecting with the spare cable.

■ **Does the interface cable specification match the specifications for the computer?**  
 Make sure the interface cable specifications match the specifications for the printer and the computer.  
 ↗ "System Requirements" on page 182

■ **When using a USB hub, is it being used correctly?**  
 In the USB specification, daisy-chains of up to five USB hubs are possible. However, we recommend that you connect the printer to the first hub connected directly to the computer. Depending on the hub you are using, the operation of the printer may become unstable. If this should occur, plug the USB cable directly into your computer's USB port.

## Problem Solver

### ■ Is the USB hub recognized correctly?

Make sure the USB hub is recognized correctly on the computer. If the computer correctly detects the USB hub, disconnect all USB hubs from the computer and connect the printer directly to the computer USB port. Ask the USB hub manufacturer about USB hub operation.

## You cannot print under the network environment.

### ■ Are the network settings correct?

Ask your network administrator for the network settings.

### ■ Connect the printer directly to the computer using a USB cable, and then try to print.

If you are able to print via USB, there is a problem with network settings. Ask your system administrator, or refer to the manual for your network system. If you cannot print via USB, see the appropriate section in this User's Guide.

## Cannot acquire information from the printer via software under the network environment

### ■ Is the SNMPv1/v2c setting disabled?

You cannot acquire information from the printer via software that uses the SNMPv1/v2c protocol if the SNMPv1/v2c setting in Remote Manager is disabled. (Example: Cannot confirm amount of remaining ink via the printer driver)

Ask your system administrator before changing the SNMP settings.

[☞ "Remote Manager" on page 26](#)

## The printer has an error.

### ■ View the message displayed in the control panel.

[☞ "Control panel" on page 12](#)

[☞ "What to do When a Message is Displayed" on page 139](#)

## The printer stops printing.

### ■ Is the status of print queue Pause? (Windows)

If you stop printing or the printer stops printing because of an error, the print queue enters a **Pause** status. You cannot print in this status.

Double-click the printer icon in the **Devices and Printers, Printers**, or **Printers and Faxes** folder; if printing is paused, open the **Printer** menu and clear the **Pause** check box.

### ■ Does the current printer status show Printing Paused (Mac OS X)?

Open the status dialog for your printer and check whether printing is paused.

(1) Select **System Preferences > Printers & Scanners** (or **Print & Fax**) > **Open Print Queue** from the **Apple** menu.

(2) Double-click the icon for any printer that is **Paused**.

(3) Click **Resume Printer**.

## Your problem is not listed here.

### ■ Decide whether the trouble is caused by the printer driver or the application. (Windows)

Perform a test print from the printer driver so that you can check that the connection between the printer and computer is correct and the printer driver settings are correct.

(1) Make sure that the printer is turned on and in ready status, and load A4 or larger paper.

(2) Open the **Devices and Printers, Printers**, or **Printers and Faxes** folder.

(3) Right-click the target printer icon, and select **Properties**.

(4) In the Properties dialog, select the **General** tab and click **Print Test Page**.

After a while the printer starts to print a test page.

If the test page is printed correctly, the connection between the printer and computer is correct. Go to the next section.

If the test page is not printed correctly, check the items above again.

[☞ "You cannot print \(because the printer does not work\)" on page 145](#)

The "Driver Version" shown on the test page is the version number of the Windows internal driver. This differs from the Epson printer driver version that you installed.

## Problem Solver

### The printer sounds like it is printing, but nothing prints

#### The print head moves, but nothing prints.

- **Confirm the printer operation.**  
Print a nozzle check pattern. Because a nozzle check pattern can be printed without connecting to a computer, you can check the operations and print status for the printer.

[☞ "Checking for clogged nozzles" on page 126](#)

Check the next section if the nozzle check pattern is not printed correctly.

- **Is the message Motor Self Adjustment displayed on the control panel's screen?**  
The printer adjusts the internal motor. Wait for a while without turning off the printer.

### The nozzle check pattern is not printed correctly.

- **Perform head cleaning.**  
The nozzles may be clogged. Print a nozzle check pattern again after performing head cleaning.

[☞ "Cleaning the print head" on page 127](#)

- **Has the printer been left unused for a long time?**  
If the printer has not been used for a long time, the nozzles may have dried up and have been clogged.

### The prints are not what you expected

#### Print quality is poor, uneven, too light, or too dark.

- **Are the print head nozzles clogged?**  
If the nozzles are clogged, specific nozzles do not fire ink and the print quality declines. Print a nozzle check pattern.

[☞ "Checking for clogged nozzles" on page 126](#)

- **Was Head Alignment performed?**  
With bidirectional printing, the print head prints while moving left and right. If the print head is misaligned, ruled lines may be misaligned accordingly. If vertical ruled lines are misaligned with bidirectional printing, perform Head Alignment.

[☞ "Adjusting print misalignments \(Head Alignment\)" on page 126](#)

- **Are you using a genuine Epson ink cartridge?**  
This printer is developed for use with Epson ink cartridges. If you use non-Epson ink cartridges, printouts may be faint, or the color of the printed image may be changed because the remaining ink level is not correctly detected. Be sure to use the correct ink cartridge.

- **Are you using an old ink cartridge?**  
The print quality declines when an old ink cartridge is used. Replace the old ink cartridge with a new one. We recommend using all the ink in the cartridge before the expiry date printed on the package (within six months of installation).

- **Have the ink cartridges been shaken?**  
The ink cartridges for this printer contain pigment inks. Shake the cartridges thoroughly before installing them in the printer.

[☞ "Replacing Ink Cartridges" on page 133](#)

- **Are the Media Type settings correct?**  
Print quality is affected if the **Media Type** you have selected in the Printer Settings screen (Windows) or Print screen (Mac OS X) in the printer driver does not match with the paper that is loaded in the printer. Be sure to match the media type setting with the paper that is loaded in the printer.

- **Did you select a low quality mode (such as Speed) as the Print Quality?**  
If the options selected for **Print Quality > Quality Options** place priority on speed, quality will be sacrificed for print speed, potentially causing print quality to decline. To improve print quality, select **Resolution** options that give priority to quality.

- **Is color management enabled?**  
Enable color management.

[☞ "Color Management Printing" on page 101](#)

## Problem Solver

### ■ Have you compared the printing result with the image on the display monitor?

Since monitors and printers produce colors differently, printed colors will not always match on-screen colors perfectly.

### ■ Did you open the printer cover while printing?

If the printer cover is opened while printing, the print head stops suddenly causing unevenness in the color. Do not open the printer cover while printing.

### ■ Is Ink Low displayed in the control panel?

The print quality may decline when the ink is low. We recommend replacing the ink cartridge with a new one. If there is a difference in color after replacing the ink cartridge, try performing head cleaning a few times.

### ■ Are you printing at High Speed on commercially available paper?

If you have selected Custom Paper from **Paper Type** and the colors are uneven in your printouts, try the following.

- If you have not registered settings for the commercially available paper  
See the following to register the settings.  
[☞ "Before Printing on Commercially Available Paper" on page 177](#)
- If you have registered settings for the commercially available paper  
Perform uni-directional printing. Follow the steps below to clear the checkbox for **High Speed** in the printer driver.  
Windows: On the Main screen, select **Quality Options** from **Print Quality**.  
Mac OS X: Select **Print Settings** from the list, and then select the **Advanced Color Settings** tab.

## The color is not exactly the same as another printer.

### ■ Colors vary depending on the printer type due to each printer's characteristics.

Because inks, printer drivers, and printer profiles are developed for each printer model, the colors printed by different printer models are not exactly the same.

You can achieve similar colors with the same color adjustment method or the same gamma setting by using the printer driver.

[☞ "Color Management Printing" on page 101](#)

To match the color precisely, use the color measurement device to perform color management.

## The print is not positioned properly on the media.

### ■ Have you specified the print area?

Check the print area in the settings of the application and the printer.

### ■ Is the correct option selected for Page Size?

If the option selected for **Page Size** or **Paper Size** in the printer driver does not match the paper loaded in the printer, the print may not be in the correct position or some of the data may be printed off the paper. In this case, check the print settings.

### ■ Is the paper skewed?

If **Off** is selected for **Paper Skew Check** in the Printer Setup menu, printing will continue even if the paper is skewed, resulting in data being printed off the paper. Select **On** for **Paper Skew Check** in the Printer Setup menu.

[☞ "Printer Setup" on page 120](#)

### ■ Does the print data fit within the paper width?

Although under normal circumstances printing stops if the print image is wider than the paper, the printer may print outside the bounds of the paper when **Off** is selected for **Paper Size Check** in the Printer Setup menu. Change the setting to **On**.

[☞ "Printer Setup Menu" on page 111](#)

### ■ Is the roll paper margin set to 15 mm or 35 mm?

If the value selected for **Roll Paper Margin** in the Paper menu is wider than the margins selected in the application, priority will be given to the value selected for **Roll Paper Margin**. For example, if 15 mm is selected for the left and right margins in the printer's Paper menu and the document fills the page, the 15 mm at the left and right sides of the page will not be printed.

[☞ "Printable area" on page 52](#)

## Problem Solver

### Vertical ruled lines are misaligned.

■ **Is the print head misaligned? (in bidirectional printing)**

With bidirectional printing, the print head prints while moving left and right. If the print head is misaligned, ruled lines may be misaligned accordingly. If vertical ruled lines are misaligned with bidirectional printing, perform Head Alignment.

 ["Adjusting print misalignments \(Head Alignment\)" on page 126](#)

### The printed surface is scuffed or soiled.

■ **Is the paper too thick or too thin?**

Check that the paper specifications are compatible with this printer.

 ["Supported Media" on page 159](#)

For information about the media types and appropriate settings for printing on paper from other manufacturers or when using RIP software, see the documentation supplied with the paper, or contact the dealer of the paper or the manufacturer of the RIP.

■ **Is the paper creased or folded?**

Do not use old paper or paper with folds in it. Always use new paper.

■ **Is the paper wavy or warped?**

If the paper becomes wavy or warped due to changes in temperature or humidity, the paper may be scuffed.

Check the following points.

- Insert the paper just before printing.
- Do not use wavy or warped paper.  
For roll paper, cut off any parts that are wavy or warped, and then load the paper again.  
For cut sheets, use new paper.

■ **Is the print head scuffing the printed surface?**

If the surface of the paper is scuffed, select a **Platen Gap** option between **Wide** and **Widest**.

 ["Custom Paper Setting" on page 117](#)

 ["Printer Setup" on page 120](#)

■ **Is the print head scuffing the edge of the paper?**

In the Paper menu, select **Top35mm/Bottom15mm** as the **Roll Paper Setup - Roll Paper Margin** option.

 ["Paper" on page 116](#)

■ **Widen the bottom margin**

Depending on the paper usage, storage conditions, and the content of the print data, the bottom edge may be scuffed when printing. In this situation it is best to create your data with a wider bottom margin.

■ **Does the interior of the printer need cleaning?**

The rollers may need cleaning. Clean the rollers by feeding and ejecting paper.

 ["Cleaning the inside" on page 137](#)

### The paper is creased.

■ **Are you using the printer at normal room temperature?**

Epson special media should be used at normal room temperature (temperature: 15 to 25°C, humidity: 40 to 60%). For information about paper such as thin paper from other manufacturers that requires special handling, see the documentation supplied with the paper.

■ **When using non-Epson special media, have you made the paper configuration?**

When using non-Epson special media, configure the paper characteristics (custom paper) before printing.

 ["Before Printing on Commercially Available Paper" on page 177](#)

### The reverse side of the printed paper is soiled.

■ **Select On for Paper Size Check in the Settings menu.**

Although printing normally stops if the print image is wider than the paper, when **Off** is selected for **Paper Size Check** in the Printer Setup menu, the printer may print outside the bounds of the paper, getting ink on the inside of the printer in the process. This can be prevented by changing the setting to **On**.

 ["Printer Setup" on page 120](#)

 ["Cleaning the inside" on page 137](#)

## Problem Solver

- Is ink dry on the printed surface?**  
Depending on the printing density and media type, the ink may take a while to dry. Do not stack the paper until the printed surface is dry.

Also, if you set the **Drying Time per Head Pass** in **Paper Configuration** from the printer driver, you can stop the operation after printing (ejecting and cutting paper) and wait until the ink is dry. See the printer driver help for more details on the Paper Configuration dialog box.

### Too much ink is fired.

- Are the Media Type settings correct?**  
Make sure that the printer driver's **Media Type** settings match the paper that you are using. The amount of ink to be fired is controlled according to the media type. If the settings do not match the paper loaded, too much ink may be fired.
- Is the Color Density setting correct?**  
Lower the density of the ink in the **Paper Configuration** dialog box from the printer driver. The printer may be firing too much ink for some paper. See the printer driver help for more details on the Paper Configuration dialog box.
- Are you printing on tracing paper?**  
If too much ink is used when printing in **B&W** on tracing paper, you may get better results by choosing a lower print density in the **Paper Configuration** dialog box.

### Margins appear in borderless printing.

- Are the settings for the print data in the application correct?**  
Make sure that the paper settings in the application are correct as well as in the printer driver.

 ["Borderless Printing" on page 78](#)
- Are the paper settings correct?**  
Make sure that the paper settings of the printer match the paper that you are using.

- Have you changed the amount of enlargement?**  
Adjust the amount of enlargement for borderless printing. Margins may appear if you set the amount of enlargement to **Min**.

 ["Borderless Printing" on page 78](#)

- Is the paper stored correctly?**  
The paper may expand or contract if it is not stored correctly so that margins appear even when borderless is set. See the documentation supplied with the paper for more information on the storage method.

- Are you using paper that supports borderless printing?**  
Paper that does not support borderless printing may expand or contract while printing so that margins appear even when borderless is set. We recommend using paper that is designed to support borderless printing.

- Try adjusting the cutter.**  
When there are margins on the top and bottom of the roll paper while performing borderless printing, try performing **Adjust Cut Position**. It may reduce the margins.

 ["Maintenance" on page 114](#)

---

## Feeding or ejecting problems

### Unable to feed or eject paper.

- Is the paper loaded in the correct position?**  
See the following for the correct paper loading positions.

 ["Loading and Removing the Roll Paper" on page 28](#)

 ["Loading and Removing Cut Sheets" on page 34](#)

If the paper is loaded correctly, check the condition of the paper that you are using.
- Is the paper loaded in the correct direction?**  
Load cut sheets vertically. If they are not loaded in the correct direction, the paper may not be recognized and an error may occur.

 ["Loading and Removing Cut Sheets" on page 34](#)

## Problem Solver

### ■ Is the paper creased or folded?

Do not use old paper or paper with folds in it. Always use new paper.

### ■ Is the paper damp?

Do not use paper that is damp. Also, Epson special media should be left in the bag until you intend to use it. If it is left out for a long time, the paper curls up and gets damp so that it does not feed properly.

### ■ Is the paper wavy or warped?

If the paper becomes wavy or warped due to changes in temperature or humidity, the printer may not be able to recognize the paper size correctly.

Check the following points.

- Insert the paper just before printing.
- Do not use wavy or warped paper.  
For roll paper, cut off any parts that are wavy or warped, and then load the paper again.  
For cut sheets, use new paper.

### ■ Is the paper too thick or too thin?

Check that the paper specifications are compatible with this printer. For information about the media types and appropriate settings for printing on paper from other manufacturers or when using RIP software, see the documentation supplied with the paper, or contact the dealer of the paper or the manufacturer of the RIP.

### ■ Are you using the printer at normal room temperature?

Epson special media should be used at normal room temperature (temperature: 15 to 25°C, humidity: 40 to 60%).

### ■ Is paper jammed in the printer?

Open the printer cover of the printer and check that there are no paper jams or foreign objects in the printer. If paper is jammed, see "Paper jams" below and clear the jammed paper.

### ■ Is the paper suction too strong?

If you continue to have problems with ejected paper, try lowering the Paper Suction (the amount of suction used to keep the paper on the paper feed path).

 ["Custom Paper Setting" on page 117](#)

## Paper does not collect in the paper basket or is creased or folded when the paper basket is used.

### ■ Does the print job require a lot of ink, or is the humidity of the workplace high?

Depending on the job and the work environment, paper may not collect in the paper basket. Take the following measures as appropriate.

- Paper does not collect in the paper basket: Use your hands to lightly press the paper into the paper basket as it is ejected from the printer.
- The paper folds after it has been cut automatically: Select manual cutting and take the paper in both hands after it is cut.
- The paper creases and does not collect well in the paper basket: Resume printing after closing the paper basket. Before the paper ejected from the printer touches the floor, take it in both hands close to the paper eject guides and continue to lightly support it until printing is complete.

## Roll paper jam

To remove jammed paper, follow the steps below:

- 1 Open the roll paper cover, and then cut the paper above the paper insertion slot using a commercially available cutter.

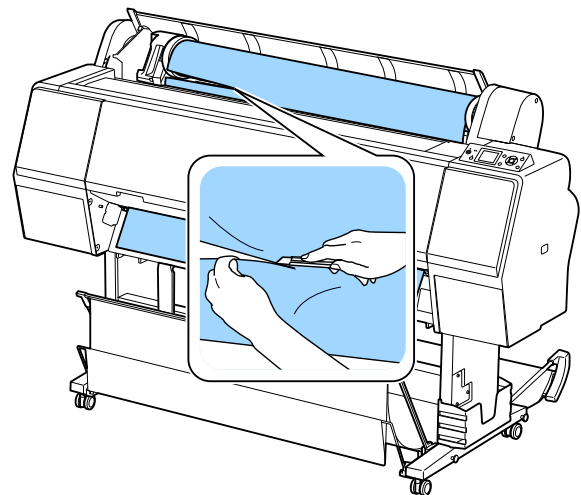

- 2 Check that the pause light is not flashing, and then press the  button to release the pressure roller.

**Problem Solver**

**3** Rewind the roll paper.

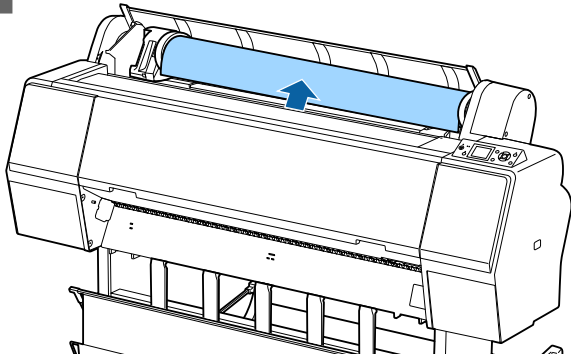

**4** Open the front cover.

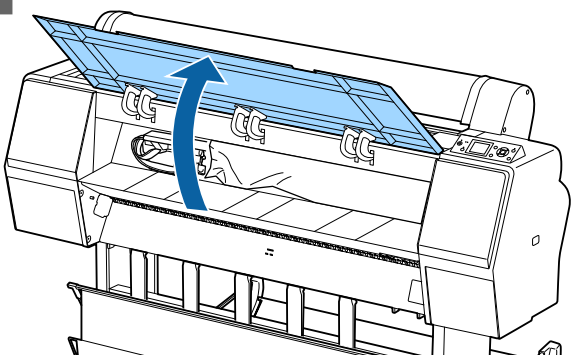

**!** **Important:**  
 Do not touch the cables around the print head.  
 Failure to observe this precaution could damage the printer.

**5** Using your hand, slowly move the print head to the side that is not jammed with paper.

**!** **Important:**  
 Other than when you are removing paper jams, do not touch the print head. If you touch the print head with your hand, static electricity may cause a malfunction.

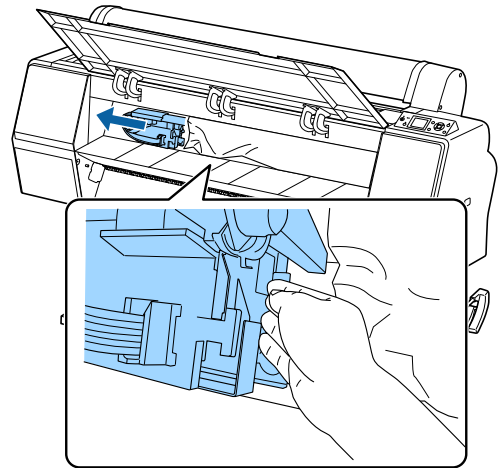

**6** Remove the jammed paper.  
 Do not touch the rollers, ink absorbing areas, or ink tubes.

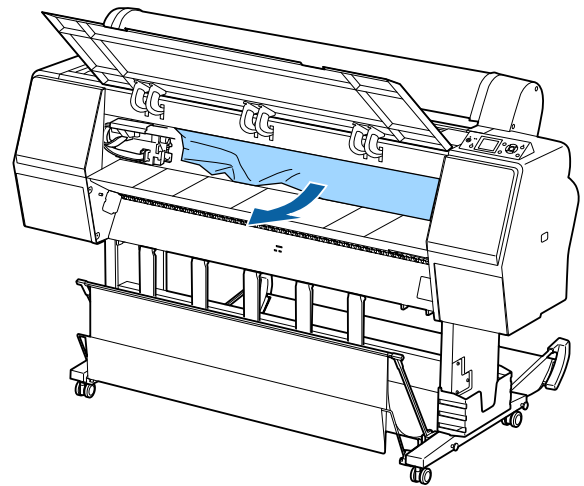

**7** Close the front cover.

**8** Turn the printer off and then back on.

**9** Reload the paper and resume printing.  
 ➔ "Loading Roll Paper" on page 28

**!** **Important:**  
 Before you reload the roll paper, cut the edge straight horizontally. Cut any wavy or creased sections. If there is a problem at the edge, decreased print quality and paper jams may occur.

**Cut sheets jam**

To remove jammed paper, follow the steps below:



**Problem Solver**

- 1** Open the front cover.

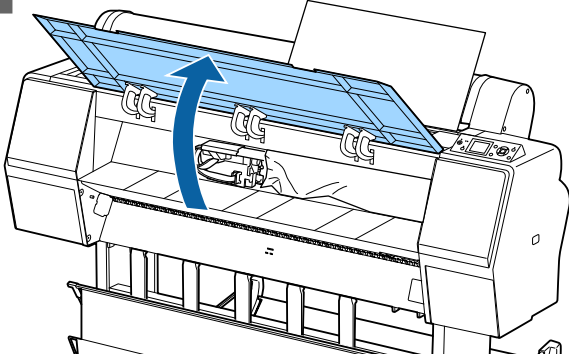

**! Important:**

*Do not touch the cables around the print head. Failure to observe this precaution could damage the printer.*

- 2** Using your hand, slowly move the print head to the side that is not jammed with paper.

**! Important:**

*Other than when you are removing paper jams, do not touch the print head. If you touch the print head with your hand, static electricity may cause a malfunction.*

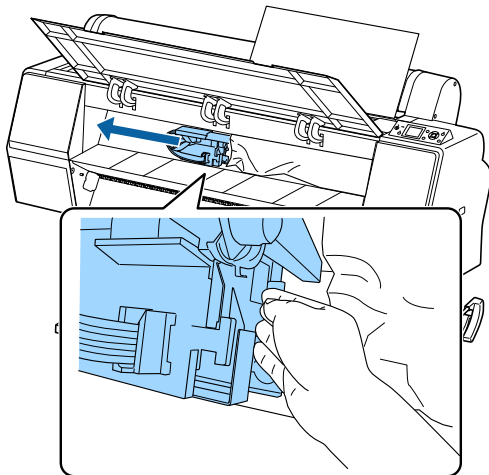

- 3** Remove the jammed paper.

Do not touch the rollers, ink absorbing areas, or ink tubes.

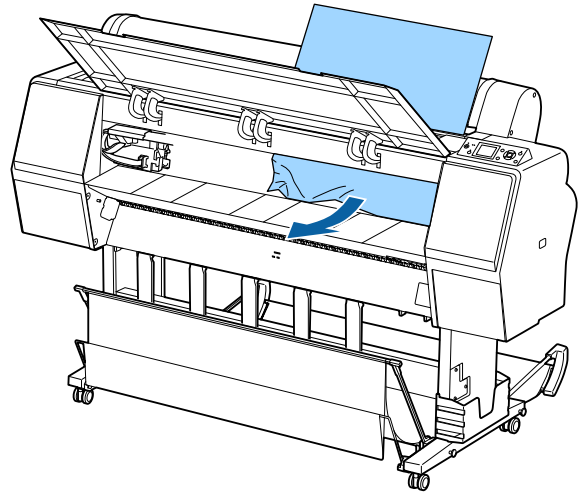

- 4** Close the front cover.

- 5** Turn the printer off and then back on.

- 6** Reload the paper and resume printing.  
[👉 "Loading and Removing Cut Sheets" on page 34](#)

**Others**

**The control panel display keeps turning off.**

■ **Is the printer in sleep mode?**

Sleep mode is exited if a print job is received or the ⏻ button on the control panel is pressed. The delay can be changed from the Preferences menu.

[👉 "Preferences" on page 123](#)

## Problem Solver

**Color ink runs out quickly even when printing in the Black&White mode or when printing black data.**

- **Color ink is consumed during the head cleaning process.**  
If all nozzles are selected when you perform **Head Cleaning** or **Powerful Cleaning**, inks of all colors will be used. (This is true even if you are currently printing in black and white.)

 ["Cleaning the print head" on page 127](#)

**The paper is not cut cleanly.**

- **Replace the cutter.**  
If the paper is not cut cleanly, replace the cutter.

 ["Replacing the Cutter" on page 135](#)

**A light is visible inside the printer.**

- **This is not a failure.**  
The light is a light inside the printer.

**The administrator password has been lost**

- Should you forget the administrator password, contact your dealer or Epson Support.

**Head cleaning is performed automatically**

- The printer may automatically perform head cleaning to ensure print quality.

**When an error occurs during color measurement (when using the SpectroProofer mounter), the colors do not match even after performing color calibration**

- **Are the temperature and humidity within the range specified for the printer (during operation) and paper?**

If the color measurement chart is printed outside the recommended environmental conditions, the correct color measurement is not acquired. See the manuals supplied with the printer and paper for the recommended environmental conditions.

Recommended environment for the printer  ["Specifications Table" on page 183](#)

- **Do the RIP or application print settings differ from the actual print conditions?**

Printing cannot be performed correctly if the paper type or black ink type differ from the RIP or application settings. Check the the paper type loaded in the printer and the black ink type settings are correct.

- **Was the color measurement chart printed with clogged nozzles?**

Check that there is no visible banding (horizontal lines at regular intervals) in the color measurement chart. If a color measurement chart is printed with clogged nozzles, the correct color measurement result cannot be acquired. If there are clogged nozzles, perform head cleaning, and then print the color measurement chart again.

 ["Cleaning the print head" on page 126](#)

- **Are there stains or scratches on the color measurement chart, or does ink peel off?**

If there are stains or scratches on the color measurement chart, or if ink peels off, the correct color measurement result cannot be acquired. Reprint the color measurement chart.

## Problem Solver

### ■ Is the color measurement chart sufficiently dry?

If the ink has not dried sufficiently, the correct color measurement result cannot be acquired. When using commercially available paper, if the drying time is not increased beyond the standard time, ink will not be dried sufficiently. Set a longer drying time in the RIP or application you are using. See the manual supplied with the RIP or application for more information in setting the drying time. See the manual supplied with the paper for more information on the drying condition.

### ■ Was custom paper information registered?

When performing calibration for commercially available paper, use one of the following methods to register custom paper information. If the paper has not been registered, you cannot select it from the Epson Color Calibration Utility paper types.

- Register the paper in the printer driver.  
Windows [☞ "Adding a Paper Type" on page 63](#)  
Mac OS X [☞ "Saving to Presets" on page 68](#)
- Register the paper in the printer.  
In **Select Reference Paper**, select anything except for **No Paper Selected**. If you select **No Paper Selected**, an error is generated in Epson Color Calibration Utility and calibration cannot be performed.  
[☞ "Custom Paper Setting" on page 117](#)

### ■ Is any external light (direct sunlight) entering the printer when performing color measurement?

If any external light enters the printer, the correct color measurement result cannot be acquired. Prevent external light from entering the printer.

## The printer turned off due to a power cut

### ■ Turn off the printer, and then turn it back on.

When the printer is not turned off normally, the print head may not be capped correctly. If the print head is left uncapped for a long time, the print quality may decline.

When you turn on the printer, capping is performed automatically after a few minutes.

Also, if the printer is turned off during calibration, data transmission and writing adjustment values may not be performed correctly. Turn on the printer, and then check **Calibration Date** from the Printer Status menu. When the date is initialized, the adjustment values are also initialized.

Exit Epson Color Calibration Utility, and then restart. The adjustment values are automatically restored.

[☞ "Printer Status" on page 121](#)

[☞ "Epson Color Calibration Utility User's Guide" \(PDF\)](#)

## Appendix

---

# Appendix

---

## Options and Consumable Products

The following options and consumable products are available for use with your printer. (As of October, 2015)

For the latest information, see the Epson Web site.

---

### Epson Special Media

 [“Epson Special Media Table” on page 159](#)

---

### Ink cartridges

Epson recommends the use of genuine Epson ink cartridges. Epson cannot guarantee the quality or reliability of non-genuine ink. The use of non-genuine ink may cause damage that is not covered by Epson's warranties, and under certain circumstances, may cause erratic printer behavior.

Information about non-genuine ink levels may not be displayed, and use of non-genuine ink is recorded for possible use in service support.

 [“Replacing Ink Cartridges” on page 133](#)

#### SC-P9000/SC-P7000, SC-P8000/SC-P6000

Color Name	Part number		
	700 ml	350ml	150ml
Photo Black	T8041	T8241	T8341
Cyan	T8042	T8242	T8342
Vivid Magenta	T8043	T8243	T8343
Yellow	T8044	T8244	T8344
Light Cyan	T8045	T8245	T8345
Vivid Light Magenta	T8046	T8246	T8346
Light Black	T8047	T8247	T8347
Matte Black	T8048	T8248	T8348
Light Light Black	T8049	T8249	T8349
Orange*	T804A	T824A	T834A
Green*	T804B	T824B	T834B
Violet*	T804D	T824D	T834D

## Appendix

\* Only available for the SC-P9000/SC-P7000.

### SC-P9070/SC-P7070, SC-P8070/SC-P6070

Color Name	Part number		
	700 ml	350ml	150ml
Photo Black	T7681	T7691	T7701
Cyan	T7682	T7692	T7702
Vivid Magenta	T7683	T7693	T7703
Yellow	T7684	T7694	T7704
Light Cyan	T7685	T7695	T7705
Vivid Light Magenta	T7686	T7696	T7706
Light Black	T7687	T7697	T7707
Matte Black	T7688	T7698	T7708
Light Light Black	T7689	T7699	T7709
Orange*	T768A	T769A	T770A
Green*	T768B	T769B	T770B
Violet*	T768D	T769D	T770D

\* Only available for the SC-P9070/SC-P7070.

### SC-P9080/SC-P7080, SC-P8080/SC-P6080







Color Name	Part number		
	700 ml	350ml	150ml
Photo Black	T8061	T8261	T8361
Cyan	T8062	T8262	T8362
Vivid Magenta	T8063	T8263	T8363
Yellow	T8064	T8264	T8364
Light Cyan	T8065	T8265	T8365
Vivid Light Magenta	T8066	T8266	T8366
Light Black	T8067	T8267	T8367
Matte Black	T8068	T8268	T8368
Light Light Black	T8069	T8269	T8369
Orange*	T806A	T826A	T836A

## Appendix

Color Name	Part number		
	700 ml	350ml	150ml
Green*	T806B	T826B	T836B
Violet*	T806D	T826D	T836D

\* Only available for the SC-P9080/SC-P7080.

## Others

Product	Part number	Explanation
Maintenance Box	T6997	Replacement part for when the current part is at the end of its service life.  <a href="#">"Replacing Maintenance Boxes" on page 134</a>
Auto Cutter Spare Blade	C12C815331	 <a href="#">"Replacing the Cutter" on page 135</a>
Roll Media Adapter	C12C811241	When loading roll paper, these attach to both ends of the paper core.  <a href="#">"Loading and Removing the Roll Paper" on page 28</a>
SpectroProofer Mounter 44 <sup>*1</sup>	C12C890521	When the optional color measurement device ILS30EP is installed and attached to the printer, color measurement is automatically performed for printed material. See the manual supplied with the mounter for more information on installing.  You need a commercially available software RIP to use the mounter.
SpectroProofer Mounter 24 <sup>*2</sup>	C12C890531	
ILS30EP	C12C932021	Color measurement device installed on the mounter. See the manual supplied with the color measurement device for more information on installing on the mounter.
Auto Take-up Reel Unit <sup>*1</sup>	C12C815323	Automatically winds printed roll paper around the paper core. See the manual supplied with the Auto take-up reel unit for more information on installing.  Use  <a href="#">"Using the Auto Take-up Reel Unit (SC-P9000 Series/SC-P8000 Series Only)" on page 43</a>
Hard Disk Unit	C12C848031	 <a href="#">"Using the Optional Hard Disk Unit" on page 57</a>
Roll Paper Belt	C12C890121	This holder keeps roll paper from unrolling after it is removed from the printer.  <a href="#">"Removing Roll Paper" on page 32</a>

\*1 Available for the SC-P9000 Series/SC-P8000 Series.

\*2 Available for the SC-P7000 Series/SC-P6000 Series.

## Appendix

# Supported Media

We recommend you use the following Epson special media for high-quality printing results.

**Note:**

For information about the media types and appropriate settings for printing on paper other than Epson special media or when using raster image processing (RIP) software, see the documentation supplied with the paper, or contact the dealer of the paper or the manufacturer of the RIP.

## Epson Special Media Table

The following provides the meaning of the table titles for supported paper sizes.

Title	Explanation
Size:	Describes the size for cut sheet media or the width for roll paper.
Borderless:	Describes whether borderless printing is available. ✓: Recommended paper, -: Unavailable paper
Calibration:	Describes whether or not Epson Color Calibration Utility is available. ✓: Available, -: Unavailable
Mounter:	Describes whether or not the optional SpectroProofer mounter is available. ✓: Available, -: Unavailable
Take-up:	Describes whether or not the optional auto take-up reel unit is available for the SC-P9000 Series/ SC-P8000 Series. (When it is available, the take-up direction is also stated.) F: Forward (printed side out), B: Backward (printed side in), -: Unavailable

## Roll Paper

### Premium Glossy Photo Paper (250)

Paper thickness: 0.27 mm

Roll core size: 3 inches

### Printer driver settings

Media Type	Photo Paper - Premium Glossy Photo Paper (250)
Type of black ink	Photo Black (PK)

### ICC profile

SC-P9000 Series/SC-P7000 Series	LLK ink set: SC-P9000_P7000_Series_LLK PremiumGlossyPhotoPaper250.icc V ink set: SC-P9000_P7000_Series_V PremiumGlossyPhotoPaper250.icc
SC-P8000 Series/SC-P6000 Series	SC-P8000_P6000_Series PremiumGlossyPhotoPaper250.icc

## Appendix

### Supported paper sizes

Size	Borderless	Calibration	Mounter	Take-up
406 mm/16 inches	✓	✓	✓	F/B
610 mm/24 inches				
914 mm/36 inches*				
1118 mm/44 inches*				

\* SC-P7000 Series/SC-P6000 Series is not supported.

### Premium Semigloss Photo Paper (250)

- Paper thickness: 0.27 mm       Roll core size: 3 inches

### Printer driver settings

Media Type	Photo Paper - Premium Semigloss Photo Paper (250)
Type of black ink	Photo Black (PK)

### ICC profile

SC-P9000 Series/SC-P7000 Series	LLK ink set: SC-P9000_P7000_Series_LLK PremiumSemiglossPhotoPaper250.icc V ink set: SC-P9000_P7000_Series_V PremiumSemiglossPhotoPaper250.icc
SC-P8000 Series/SC-P6000 Series	SC-P8000_P6000_Series PremiumSemiglossPhotoPaper250.icc

### Supported paper sizes

Size	Borderless	Calibration	Mounter	Take-up
406 mm/16 inches	✓	✓	✓	F/B
610 mm/24 inches				
914 mm/36 inches*				
1118 mm/44 inches*				

\* SC-P7000 Series/SC-P6000 Series is not supported.

### Premium Luster Photo Paper (260)

- Paper thickness: 0.27 mm       Roll core size: 3 inches

### Printer driver settings

Media Type	Photo Paper - Premium Luster Photo Paper (260)
Type of black ink	Photo Black (PK)



**Appendix**

**ICC profile**

SC-P9000 Series/SC-P7000 Series	LLK ink set: SC-P9000_P7000_Series_LLK PremiumLusterPhotoPaper260.icc V ink set: SC-P9000_P7000_Series_V PremiumLusterPhotoPaper260.icc
SC-P8000 Series/SC-P6000 Series	SC-P8000_P6000_Series PremiumLusterPhotoPaper260.icc

**Supported paper sizes**

Size	Borderless	Calibration	Mounter	Take-up
254 mm/10 inches	✓	-	✓	-
300mm		✓		✓
406 mm/16 inches				
508 mm/20 inches	-			
610 mm/24 inches				
914 mm/36 inches*	✓			
1118 mm/44 inches*				

\* SC-P7000 Series/SC-P6000 Series is not supported.

**Premium Semimatte Photo Paper (260)**

- Paper thickness: 0.268mm
- Roll core size: 3 inches

**Printer driver settings**

Media Type	Photo Paper - Premium Semimatte Photo Paper (260)
Type of black ink	Photo Black (PK)

**ICC profile**

SC-P9000 Series/SC-P7000 Series	LLK ink set: SC-P9000_P7000_Series_LLK PremiumSemimattePhotoPaper260.icc V ink set: SC-P9000_P7000_Series_V PremiumSemimattePhotoPaper260.icc
SC-P8000 Series/SC-P6000 Series	SC-P8000_P6000_Series PremiumSemimattePhotoPaper260.icc

**Supported paper sizes**

Size	Borderless	Calibration	Mounter	Take-up
406 mm/16 inches	✓	✓	✓	F/B
610 mm/24 inches				
914 mm/36 inches*				
1118 mm/44 inches*				

## Appendix

\* SC-P7000 Series/SC-P6000 Series is not supported.

### Premium Glossy Photo Paper (170)

Paper thickness: 0.18mm

Roll core size: 2 inches

#### Printer driver settings

Media Type	Photo Paper - Premium Glossy Photo Paper (170)
Type of black ink	Photo Black (PK)

#### ICC profile

SC-P9000 Series/SC-P7000 Series	LLK ink set: SC-P9000_P7000_Series_LLK PremiumGlossyPhotoPaper170.icc V ink set: SC-P9000_P7000_Series_V PremiumGlossyPhotoPaper170.icc
SC-P8000 Series/SC-P6000 Series	SC-P8000_P6000_Series PremiumGlossyPhotoPaper170.icc

#### Supported paper sizes

Size	Borderless	Calibration	Mounter	Take-up
420 mm/A2	-			
610 mm/24 inches				
728 mm/B1*	✓	✓	✓	F/B
914 mm/36 inches*				
1118 mm/44 inches*				

\* SC-P7000 Series/SC-P6000 Series is not supported.

### Premium Semigloss Photo Paper (170)

Paper thickness: 0.18mm

Roll core size: 2 inches

#### Printer driver settings

Media Type	Photo Paper - Premium Semigloss Photo Paper (170)
Type of black ink	Photo Black (PK)

#### ICC profile

SC-P9000 Series/SC-P7000 Series	LLK ink set: SC-P9000_P7000_Series_LLK PremiumSemiglossPhotoPaper170.icc V ink set: SC-P9000_P7000_Series_V PremiumSemiglossPhotoPaper170.icc
SC-P8000 Series/SC-P6000 Series	SC-P8000_P6000_Series PremiumSemiglossPhotoPaper170.icc

## Appendix

### Supported paper sizes

Size	Borderless	Calibration	Mounter	Take-up
420 mm/A2	-			
610 mm/24 inches	✓	✓	✓	F/B
914 mm/36 inches*				
1118 mm/44 inches*				

\* SC-P7000 Series/SC-P6000 Series is not supported.

### Photo Paper Gloss 250

Paper thickness: 0.25mm

Roll core size: 3 inches

### Printer driver settings

Media Type	Photo Paper - Photo Paper Gloss 250
Type of black ink	Photo Black (PK)

### ICC profile

SC-P9000 Series/SC-P7000 Series	LLK ink set: SC-P9000_P7000_Series_LLK PhotoPaperGloss250.icc V ink set: SC-P9000_P7000_Series_V PhotoPaperGloss250.icc
SC-P8000 Series/SC-P6000 Series	SC-P8000_P6000_Series PhotoPaperGloss250.icc

### Supported paper sizes

Size	Borderless	Calibration	Mounter	Take-up
432 mm/17 inches	✓	✓	✓	F/B
610 mm/24 inches				
914 mm/36 inches*				
1118 mm/44 inches*				

\* SC-P7000 Series/SC-P6000 Series is not supported.

### EPSON Proofing Paper White Semimatte

Paper thickness: 0.2mm

Roll core size: 3 inches

### Printer driver settings

Media Type	Proofing Paper - Epson Proofing Paper White Semimatte
Type of black ink	Photo Black (PK)

## Appendix

### ICC profile

SC-P9000 Series/SC-P7000 Series	LLK ink set: SC-P9000_P7000_Series_LLK EpsonProofingPaperWhiteSemimatte.icc V ink set: SC-P9000_P7000_Series_V EpsonProofingPaperWhiteSemimatte.icc
SC-P8000 Series/SC-P6000 Series	SC-P8000_P6000_Series EpsonProofingPaperWhiteSemimatte.icc

### Supported paper sizes

Size	Borderless	Calibration	Mounter	Take-up
329 mm/13 inches	-	✓	✓	-
432 mm/17 inches				F/B
610 mm/24 inches				
914 mm/36 inches*				
1118 mm/44 inches*				

\* SC-P7000 Series/SC-P6000 Series is not supported.

### EPSON Proofing Paper Commercial

Paper thickness: 0.196mm

Roll core size: 3 inches

### Printer driver settings

Media Type	Proofing Paper - Epson Proofing Paper Commercial
Type of black ink	Photo Black (PK)

### ICC profile

SC-P9000 Series/SC-P7000 Series	LLK ink set: SC-P9000_P7000_Series_V EpsonProofingPaperCommercial.icc V ink set: SC-P9000_P7000_Series_LLK EpsonProofingPaperCommercial.icc
SC-P8000 Series/SC-P6000 Series	SC-P8000_P6000_Series EpsonProofingPaperCommercial.icc

### Supported paper sizes

Size	Borderless	Calibration	Mounter	Take-up
329 mm/13 inches	-	✓	✓	-
432 mm/17 inches				F/B
610 mm/24 inches				
914 mm/36 inches*				
1118 mm/44 inches*				

## Appendix

\* SC-P7000 Series/SC-P6000 Series is not supported.

### Singleweight Matte Paper

Paper thickness: 0.14mm

Roll core size: 2 inches

#### Printer driver settings

Media Type	Matte Paper - Singleweight Matte Paper
Type of black ink	Matte Black (MK)

#### ICC profile

SC-P9000 Series/SC-P7000 Series	SC-P9000_P7000_Series Standard.icc
SC-P8000 Series/SC-P6000 Series	SC-P8000_P6000_Series Standard.icc

#### Supported paper sizes

Size	Borderless	Calibration	Mounter	Take-up
419 mm/16.5 inches	-			F
432 mm/17 inches				
610 mm/24 inches	✓	✓	-	
914 mm/36 inches* <sup>1</sup>				F* <sup>2</sup>
1118 mm/44 inches* <sup>1</sup>				

\*<sup>1</sup> SC-P7000 Series/SC-P6000 Series is not supported.

\*<sup>2</sup> Use the tensioner supplied with the optional auto take-up reel unit.

### Doubleweight Matte Paper

Paper thickness: 0.21mm

Roll core size: 2 inches

#### Printer driver settings

Media Type	Matte Paper - Doubleweight Matte Paper
Type of black ink	Matte Black (MK)

#### ICC profile

SC-P9000 Series/SC-P7000 Series	SC-P9000_P7000_Series Standard.icc
SC-P8000 Series/SC-P6000 Series	SC-P8000_P6000_Series Standard.icc

## Appendix

### Supported paper sizes

Size	Borderless	Calibration	Mounter	Take-up
610 mm/24 inches	✓	✓	✓*2	F
914 mm/36 inches*1				
1118 mm/44 inches*1				

\*1 SC-P7000 Series/SC-P6000 Series is not supported.

\*2 Only operations guaranteed. (Color measurement not guaranteed.)

### Enhanced Matte Paper

Paper thickness: 0.2mm

Roll core size: 3 inches

### Printer driver settings

Media Type	Matte Paper - Enhanced Matte Paper
Type of black ink	Photo Black (PK), Matte Black (MK)

### ICC profile

SC-P9000 Series/SC-P7000 Series	<p><b>LLK ink set:</b></p> <ul style="list-style-type: none"> <li><input type="checkbox"/> PK: SC-P9000_P7000_Series_LLK EnhancedMattePaper_PK.icc</li> <li><input type="checkbox"/> MK: SC-P9000_P7000_Series_LLK EnhancedMattePaper_MK.icc</li> </ul> <p><b>V ink set:</b></p> <ul style="list-style-type: none"> <li><input type="checkbox"/> PK: SC-P9000_P7000_Series_V EnhancedMattePaper_PK.icc</li> <li><input type="checkbox"/> MK: SC-P9000_P7000_Series_V EnhancedMattePaper_MK.icc</li> </ul>
SC-P8000 Series/SC-P6000 Series	<ul style="list-style-type: none"> <li><input type="checkbox"/> PK: SC-P8000_P6000_Series EnhancedMattePaper_PK.icc</li> <li><input type="checkbox"/> MK: SC-P8000_P6000_Series EnhancedMattePaper_MK.icc</li> </ul>

### Supported paper sizes

Size	Borderless	Calibration	Mounter	Take-up
432 mm/17 inches	-	✓	✓*2	F
610 mm/24 inches				
914 mm/36 inches*1				
1118 mm/44 inches*1				

\*1 SC-P7000 Series/SC-P6000 Series is not supported.

\*2 Only operations guaranteed. (Color measurement not guaranteed.)

## Appendix

### Watercolor Paper - Radiant White

- Paper thickness: 0.29mm  Roll core size: 3 inches

#### Printer driver settings

Media Type	Fine Art Paper - Watercolor Paper - Radiant White
Type of black ink	Photo Black (PK), Matte Black (MK)

#### ICC profile

SC-P9000 Series/SC-P7000 Series	<p><b>LLK ink set:</b></p> <ul style="list-style-type: none"> <li><input type="checkbox"/> PK: SC-P9000_P7000_Series_LLK WatercolorPaper-RadiantWhite_PK.icc</li> <li><input type="checkbox"/> MK: SC-P9000_P7000_Series_LLK WatercolorPaper-RadiantWhite_MK.icc</li> </ul> <p><b>V ink set:</b></p> <ul style="list-style-type: none"> <li><input type="checkbox"/> PK: SC-P9000_P7000_Series_V WatercolorPaper-RadiantWhite_PK.icc</li> <li><input type="checkbox"/> MK: SC-P9000_P7000_Series_V WatercolorPaper-RadiantWhite_MK.icc</li> </ul>
SC-P8000 Series/SC-P6000 Series	<ul style="list-style-type: none"> <li><input type="checkbox"/> PK: SC-P8000_P6000_Series WatercolorPaper-RadiantWhite_PK.icc</li> <li><input type="checkbox"/> MK: SC-P8000_P6000_Series WatercolorPaper-RadiantWhite_MK.icc</li> </ul>

#### Supported paper sizes

Size	Borderless	Calibration	Mounter	Take-up
610 mm/24 inches	-	✓	✓*2	F/B
914 mm/36 inches*1				
1118 mm/44 inches*1				

\*1 SC-P7000 Series/SC-P6000 Series is not supported.

\*2 Only operations guaranteed. (Color measurement not guaranteed.)

### UltraSmooth Fine Art Paper

- Paper thickness: 0.32mm  Roll core size: 3 inches

#### Printer driver settings

Media Type	Fine Art Paper - UltraSmooth Fine Art Paper
Type of black ink	Photo Black (PK), Matte Black (MK)

## Appendix

### ICC profile

SC-P9000 Series/SC-P7000 Series	<b>LLK ink set:</b> <input type="checkbox"/> PK: SC-P9000_P7000_Series_LLK UltraSmoothFineArtPaper_PK.icc <input type="checkbox"/> MK: SC-P9000_P7000_Series_LLK UltraSmoothFineArtPaper_MK.icc <b>V ink set:</b> <input type="checkbox"/> PK: SC-P9000_P7000_Series_V UltraSmoothFineArtPaper_PK.icc <input type="checkbox"/> MK: SC-P9000_P7000_Series_V UltraSmoothFineArtPaper_MK.icc
SC-P8000 Series/SC-P6000 Series	<input type="checkbox"/> PK: SC-P8000_P6000_Series UltraSmoothFineArtPaper_PK.icc <input type="checkbox"/> MK: SC-P8000_P6000_Series UltraSmoothFineArtPaper_MK.icc

### Supported paper sizes

Size	Borderless	Calibration	Mounter	Take-up
432 mm/17 inches	-	✓	✓*2	F/B
610 mm/24 inches				
1118 mm/44 inches*1				

\*1 SC-P7000 Series/SC-P6000 Series is not supported.

\*2 Only operations guaranteed. (Color measurement not guaranteed.)

### Enhanced synthetic paper

- Paper thickness: 0.12mm
- Roll core size: 2 inches

### Printer driver settings

Media Type	Others - Enhanced Synthetic Paper
Type of black ink	Matte Black (MK)

### ICC profile

SC-P9000 Series/SC-P7000 Series	SC-P9000_P7000_Series Standard.icc
SC-P8000 Series/SC-P6000 Series	SC-P8000_P6000_Series Standard.icc

### Supported paper sizes

Size	Borderless	Calibration	Mounter	Take-up
610 mm/24 inches	-	✓	-	F/B
1118 mm/44 inches*				

\* SC-P7000 Series/SC-P6000 Series is not supported.



## Appendix

### Enhanced adhesive synthetic paper

- Paper thickness: 0.17mm  Roll core size: 2 inches

#### Printer driver settings

Media Type	Others - Enhanced Adhesive Synthetic Paper
Type of black ink	Matte Black (MK)

#### ICC profile

SC-P9000 Series/SC-P7000 Series	SC-P9000_P7000_Series Standard.icc
SC-P8000 Series/SC-P6000 Series	SC-P8000_P6000_Series Standard.icc

#### Supported paper sizes

Size	Borderless	Calibration	Mounter	Take-up
610 mm/24 inches	-	✓	-	F/B
1118 mm/44 inches*				

\* SC-P7000 Series/SC-P6000 Series is not supported.

## Cut sheet

### Premium Glossy Photo Paper

- Paper thickness: 0.27 mm

#### Printer driver settings

Media Type	Photo Paper - Premium Glossy Photo Paper
Type of black ink	Photo Black (PK)

#### ICC profile

SC-P9000 Series/SC-P7000 Series	LLK ink set: SC-P9000_P7000_Series_LLK PremiumGlossyPhotoPaper.icc V ink set: SC-P9000_P7000_Series_V PremiumGlossyPhotoPaper.icc
SC-P8000 Series/SC-P6000 Series	SC-P8000_P6000_Series PremiumGlossyPhotoPaper.icc

## Appendix

### Supported paper sizes

Size	Borderless	Calibration	Mounter
A3	-	✓	-
S-B/A3+			
A2			

### Premium Semigloss Photo Paper

Paper thickness: 0.27 mm

### Printer driver settings

Media Type	Photo Paper - Premium Semigloss Photo Paper
Type of black ink	Photo Black (PK)

### ICC profile

SC-P9000 Series/SC-P7000 Series	LLK ink set: SC-P9000_P7000_Series_LLK PremiumSemiglossPhotoPaper.icc V ink set: SC-P9000_P7000_Series_V PremiumSemiglossPhotoPaper.icc
SC-P8000 Series/SC-P6000 Series	SC-P8000_P6000_Series PremiumSemiglossPhotoPaper.icc

### Supported paper sizes

Size	Borderless	Calibration	Mounter
A3	-	✓	-
S-B/A3+			
A2			✓

### Premium Luster Photo Paper

Paper thickness: 0.27 mm

### Printer driver settings

Media Type	Photo Paper - Premium Luster Photo Paper
Type of black ink	Photo Black (PK)

### ICC profile

SC-P9000 Series/SC-P7000 Series	LLK ink set: SC-P9000_P7000_Series_LLK PremiumLusterPhotoPaper.icc V ink set: SC-P9000_P7000_Series_V PremiumLusterPhotoPaper.icc
SC-P8000 Series/SC-P6000 Series	SC-P8000_P6000_Series PremiumLusterPhotoPaper.icc

## Appendix

### Supported paper sizes

Size	Borderless	Calibration	Mounter
S-B/A3+	-	✓	-
A2			✓

### **EPSON Proofing Paper White Semimatte**

Paper thickness: 0.2mm

### Printer driver settings

Media Type	Proofing Paper - Epson Proofing Paper White Semimatte
Type of black ink	Photo Black (PK)

### ICC profile

SC-P9000 Series/SC-P7000 Series	LLK ink set: SC-P9000_P7000_Series_LLK EpsonProofingPaperWhiteSemimatte.icc V ink set: SC-P9000_P7000_Series_V EpsonProofingPaperWhiteSemimatte.icc
SC-P8000 Series/SC-P6000 Series	SC-P8000_P6000_Series EpsonProofingPaperWhiteSemimatte.icc

### Supported paper sizes

Size	Borderless	Calibration	Mounter
S-B/A3+	-	✓	-
A3++			-

### **Photo Quality Ink Jet Paper**

Paper thickness: 0.12mm

### Printer driver settings

Media Type	Matte Paper - Photo Quality Ink Jet Paper
Type of black ink	Matte Black (MK)

### ICC profile

SC-P9000 Series/SC-P7000 Series	SC-P9000_P7000_Series Standard.icc
SC-P8000 Series/SC-P6000 Series	SC-P8000_P6000_Series Standard.icc

## Appendix

### Supported paper sizes

Size	Borderless	Calibration	Mounter
A3	-	-	-
S-B/A3+			
A2			

### Archival Matte Paper

- Paper thickness: 0.2mm

### Printer driver settings

Media Type	Matte Paper - Archival Matte Paper
Type of black ink	Photo Black (PK), Matte Black (MK)

### ICC profile

SC-P9000 Series/SC-P7000 Series	<p><b>LLK ink set:</b></p> <ul style="list-style-type: none"> <li><input type="checkbox"/> PK: SC-P9000_P7000_Series_LLK ArchivalMattePaper_PK.icc</li> <li><input type="checkbox"/> MK: SC-P9000_P7000_Series_LLK ArchivalMattePaper_MK.icc</li> </ul> <p><b>V ink set:</b></p> <ul style="list-style-type: none"> <li><input type="checkbox"/> PK: SC-P9000_P7000_Series_V ArchivalMattePaper_PK.icc</li> <li><input type="checkbox"/> MK: SC-P9000_P7000_Series_V ArchivalMattePaper_MK.icc</li> </ul>
SC-P8000 Series/SC-P6000 Series	<ul style="list-style-type: none"> <li><input type="checkbox"/> PK: SC-P8000_P6000_Series ArchivalMattePaper_PK.icc</li> <li><input type="checkbox"/> MK: SC-P8000_P6000_Series ArchivalMattePaper_MK.icc</li> </ul>

### Supported paper sizes

Size	Borderless	Calibration	Mounter
A3	-	✓	-
S-B/A3+			
A2			✓*2
US-C*1			

\*1 SC-P7000 Series/SC-P6000 Series is not supported.

\*2 Only operations guaranteed. (Color measurement not guaranteed.)

### Enhanced Matte Paper

- Paper thickness: 0.2mm

## Appendix

### Printer driver settings

Media Type	Matte Paper - Enhanced Matte Paper
Type of black ink	Photo Black (PK), Matte Black (MK)

### ICC profile

SC-P9000 Series/SC-P7000 Series	<p><b>LLK ink set:</b></p> <ul style="list-style-type: none"> <li><input type="checkbox"/> PK: SC-P9000_P7000_Series_LLK EnhancedMattePaper_PK.icc</li> <li><input type="checkbox"/> MK: SC-P9000_P7000_Series_LLK EnhancedMattePaper_MK.icc</li> </ul> <p><b>V ink set:</b></p> <ul style="list-style-type: none"> <li><input type="checkbox"/> PK: SC-P9000_P7000_Series_V EnhancedMattePaper_PK.icc</li> <li><input type="checkbox"/> MK: SC-P9000_P7000_Series_V EnhancedMattePaper_MK.icc</li> </ul>
SC-P8000 Series/SC-P6000 Series	<ul style="list-style-type: none"> <li><input type="checkbox"/> PK: SC-P8000_P6000_Series EnhancedMattePaper_PK.icc</li> <li><input type="checkbox"/> MK: SC-P8000_P6000_Series EnhancedMattePaper_MK.icc</li> </ul>

### Supported paper sizes

Size	Borderless	Calibration	Mounter
A2	-	✓	✓*2
US-C*1			

\*1 SC-P7000 Series/SC-P6000 Series is not supported.

\*2 Only operations guaranteed. (Color measurement not guaranteed.)

### Watercolor Paper - Radiant White

- Paper thickness: 0.29mm

### Printer driver settings

Media Type	Fine Art Paper - Watercolor Paper - Radiant White
Type of black ink	Photo Black (PK), Matte Black (MK)

### ICC profile

SC-P9000 Series/SC-P7000 Series	<p><b>LLK ink set:</b></p> <ul style="list-style-type: none"> <li><input type="checkbox"/> PK: SC-P9000_P7000_Series_LLK WatercolorPaper-RadiantWhite_PK.icc</li> <li><input type="checkbox"/> MK: SC-P9000_P7000_Series_LLK WatercolorPaper-RadiantWhite_MK.icc</li> </ul> <p><b>V ink set:</b></p> <ul style="list-style-type: none"> <li><input type="checkbox"/> PK: SC-P9000_P7000_Series_V WatercolorPaper-RadiantWhite_PK.icc</li> <li><input type="checkbox"/> MK: SC-P9000_P7000_Series_V WatercolorPaper-RadiantWhite_MK.icc</li> </ul>
SC-P8000 Series/SC-P6000 Series	<ul style="list-style-type: none"> <li><input type="checkbox"/> PK: SC-P8000_P6000_Series WatercolorPaper-RadiantWhite_PK.icc</li> <li><input type="checkbox"/> MK: SC-P8000_P6000_Series WatercolorPaper-RadiantWhite_MK.icc</li> </ul>

## Appendix

### Supported paper sizes

Size	Borderless	Calibration	Mounter
S-B/A3+	-	✓	-

### UltraSmooth Fine Art Paper

- Paper thickness: 0.46mm

### Printer driver settings

Media Type	Fine Art Paper - UltraSmooth Fine Art Paper
Type of black ink	Photo Black (PK), Matte Black (MK)

### ICC profile

SC-P9000 Series/SC-P7000 Series	<p><b>LLK ink set:</b></p> <ul style="list-style-type: none"> <li><input type="checkbox"/> PK: SC-P9000_P7000_Series_LLK UltraSmoothFineArtPaper_PK.icc</li> <li><input type="checkbox"/> MK: SC-P9000_P7000_Series_LLK UltraSmoothFineArtPaper_MK.icc</li> </ul> <p><b>V ink set:</b></p> <ul style="list-style-type: none"> <li><input type="checkbox"/> PK: SC-P9000_P7000_Series_V UltraSmoothFineArtPaper_PK.icc</li> <li><input type="checkbox"/> MK: SC-P9000_P7000_Series_V UltraSmoothFineArtPaper_MK.icc</li> </ul>
SC-P8000 Series/SC-P6000 Series	<ul style="list-style-type: none"> <li><input type="checkbox"/> PK: SC-P8000_P6000_Series UltraSmoothFineArtPaper_PK.icc</li> <li><input type="checkbox"/> MK: SC-P8000_P6000_Series UltraSmoothFineArtPaper_MK.icc</li> </ul>

### Supported paper sizes

Size	Borderless	Calibration	Mounter
S-B/A3+	-	✓	-
A2			✓*2
US-C*1			

\*1 SC-P7000 Series/SC-P6000 Series is not supported.

\*2 Only operations guaranteed. (Color measurement not guaranteed.)

### Velvet Fine Art Paper

- Paper thickness: 0.48mm

### Printer driver settings

Media Type	Fine Art Paper - Velvet Fine Art Paper
Type of black ink	Photo Black (PK), Matte Black (MK)

## Appendix

### ICC profile

SC-P9000 Series/SC-P7000 Series	<p><b>LLK ink set:</b></p> <ul style="list-style-type: none"> <li><input type="checkbox"/> PK: SC-P9000_P7000_Series_LLK VelvetFineArtPaper_PK.icc</li> <li><input type="checkbox"/> MK: SC-P9000_P7000_Series_LLK VelvetFineArtPaper_MK.icc</li> </ul> <p><b>V ink set:</b></p> <ul style="list-style-type: none"> <li><input type="checkbox"/> PK: SC-P9000_P7000_Series_V VelvetFineArtPaper_PK.icc</li> <li><input type="checkbox"/> MK: SC-P9000_P7000_Series_V VelvetFineArtPaper_MK.icc</li> </ul>
SC-P8000 Series/SC-P6000 Series	<ul style="list-style-type: none"> <li><input type="checkbox"/> PK: SC-P8000_P6000_Series VelvetFineArtPaper_PK.icc</li> <li><input type="checkbox"/> MK: SC-P8000_P6000_Series VelvetFineArtPaper_MK.icc</li> </ul>

### Supported paper sizes

Size	Borderless	Calibration	Mounter
S-B/A3+			-
A2	-	✓	✓*2
US-C*1			

\*1 SC-P7000 Series/SC-P6000 Series is not supported.

\*2 Only operations guaranteed. (Color measurement not guaranteed.)

### Enhanced Matte Poster Board

- Paper thickness: 1.3mm

### Printer driver settings

Media Type	Fine Art Paper - Enhanced Matte Poster Board
Type of black ink	Photo Black (PK), Matte Black (MK)

### ICC profile

SC-P9000 Series/SC-P7000 Series	<p><b>LLK ink set:</b></p> <ul style="list-style-type: none"> <li><input type="checkbox"/> PK: SC-P9000_P7000_Series_LLK EnhancedMattePosterBoard_PK.icc</li> <li><input type="checkbox"/> MK: SC-P9000_P7000_Series_LLK EnhancedMattePosterBoard_MK.icc</li> </ul> <p><b>V ink set:</b></p> <ul style="list-style-type: none"> <li><input type="checkbox"/> PK: SC-P9000_P7000_Series_V EnhancedMattePosterBoard_PK.icc</li> <li><input type="checkbox"/> MK: SC-P9000_P7000_Series_V EnhancedMattePosterBoard_MK.icc</li> </ul>
SC-P8000 Series/SC-P6000 Series	<ul style="list-style-type: none"> <li><input type="checkbox"/> PK: SC-P8000_P6000_Series EnhancedMattePosterBoard_PK.icc</li> <li><input type="checkbox"/> MK: SC-P8000_P6000_Series EnhancedMattePosterBoard_MK.icc</li> </ul>

## Appendix

### Supported paper sizes

Size	Borderless	Calibration	Mounter
610 mm (24") × 762 mm (30")	-	-	-
762 mm (30") × 1016 mm (40")*			

\* SC-P7000 Series/SC-P6000 Series is not supported.

## Supported Commercially Available Paper

When using commercially available paper, make sure you register the paper information.

 [“Before Printing on Commercially Available Paper” on page 177](#)

This printer supports the following paper specifications for non-Epson media.



### Important:

- Do not use paper that is wrinkled, scuffed, torn, or dirty.
- Although plain paper and recycled paper manufactured by other companies can be loaded and fed in the printer as long as they meet the following specifications, Epson cannot guarantee the print quality.
- Although other paper types manufactured by other companies can be loaded in the printer as long as they meet the following specifications, Epson cannot guarantee the paper feeding and print quality.
- When using the SpectroProofer mounter, see the documentation supplied with your software RIP.

### Roll Paper

Roll core size	2 inch and 3 inch
Roll paper outer diameter	2-inch core: 103 mm or less 3-inch core: 150 mm or less
Paper Width	SC-P9000 Series/SC-P8000 Series: 254 mm (10 inches) to 1,118 mm (44 inches) SC-P7000 Series/SC-P6000 Series: 254 mm (10 inches) to 610 mm (24 inches)
Paper Length	2-inch core: 45 m or less 3-inch core: 202 m or less
Thickness	0.08mm to 0.5mm

### Cut sheet

Paper Width	SC-P9000 Series/SC-P8000 Series: 182 mm (B5) to 1,118 mm (44 inches) SC-P7000 Series/SC-P6000 Series: 182 mm (B5) to 620 mm* <sup>1</sup>
Paper Length* <sup>2</sup>	SC-P9000 Series/SC-P8000 Series: 297 mm (A4) to 1580 mm (B0+) SC-P7000 Series/SC-P6000 Series: 297 mm (A4) to 914 mm (A1+)



## Appendix

Thickness	0.08 mm to 1.5 mm (0.5 mm to 1.5 mm for thick paper)
-----------	--

\*1 The printable area is 610 mm (24 inches).

 [“Cut Sheets Printable Area” on page 53](#)

\*2 762 mm for thick paper.

## Supported paper widths for borderless printing (for roll paper and cut sheets)

Available for All models		Only for SC-P9000 Series/SC-P8000 Series
254mm/10inch	US C/ 432mm/17inch	B1/728mm
300mm/11.8inch	B2/515 mm	Super A0/914mm/36inch
Super A3/B/329 mm/13inch	A1/594mm	Super B0/1118mm/44inch
406mm/16inch	Super A1/610mm/24inch	

## When using the Epson Color Calibration Utility

**Even if the specified conditions are met, you cannot use the following paper types.**

- Paper that is thin and soft (plain paper and so on)
- Paper with an uneven print surface
- Paper that is colored or transparent
- Paper on which ink blurs or overflows when printing
- Paper which bends seriously during loading and printing

**When performing color calibration for multiple printers, you can only use cut sheets A3 size or larger.**

For one printer, you can use A3 size or larger roll paper as well as cut sheets.

---

## Before Printing on Commercially Available Paper

**Note:**

- Be sure to check the paper characteristics (such as if the paper is glossy, the material, and the thickness) in the manual provided with the paper or contact the dealer of the paper.
- Test the print quality with this printer before purchasing a large amount of paper.

When using non-Epson media (Custom Paper), make the paper configuration according to the paper characteristics before printing. Printing without making configuring may cause wrinkles, rubbing, uneven colors, and so on.



Make sure you set the following three items.

## Appendix

Select Reference Paper	<p>The optimum settings for using different types of Epson special media have already been registered to this printer.</p> <p>Check the following, and then select the Epson special media type that is closest to the paper you are using.</p> <ul style="list-style-type: none"> <li><input type="checkbox"/> Glossy paper*: <b>Photo Paper</b> or <b>Proofing Paper</b></li> <li><input type="checkbox"/> Thick paper that is not glossy: <b>Matte Paper</b></li> <li><input type="checkbox"/> Thin, soft paper that is not glossy: <b>Plain Paper</b></li> <li><input type="checkbox"/> Cotton paper with an uneven surface: <b>Fine Art Paper</b></li> <li><input type="checkbox"/> Special media such as film, cloth, poster board, and tracing paper: <b>Others</b></li> </ul>
Thickness	<p>Set the thickness of the paper. If you do not know the exact thickness, set <b>Detect Paper Thickness</b> from the control panel's Paper menu.</p> <p>This allows you to reduce the grainy feeling and scuff marks in print outs, as well as differences in the print position and color.</p>
Paper Feed Adjust	Optimizes the paper feed when printing. Reduces banding (horizontal stripes) or uneven colors.

\* Check which to select in the manual provided with the paper or contact the dealer of the paper.

Make settings using one of the following methods.

- Set **Custom Paper Setting** from the control panel's Paper menu.  
You can make paper settings for all items except for the three mentioned above.  
 ["From the printer" on page 179](#)
- Set in EPSON LFP Remote Panel 2 (software supplied)  
You can make the same settings as the control panel's Paper menu from a computer. For details, see the EPSON LFP Remote Panel 2 help.
- Set in the printer driver.  
Make settings from the printer driver, and save to a computer.  
When **Custom Paper** is selected in **Select Paper Type** from the control panel's Paper menu, the control panel's settings are enabled regardless of the printer driver settings.  
 ["From the printer driver" on page 179](#)

When you have finished making settings, print using the saved settings and check the results. If you are not satisfied with the print results, check the following and set the item according to the problem.

 ["The prints are not what you expected" on page 147](#)

### **Important:**

*If you change one item set in the Paper menu, you need to perform **Paper Feed Adjust** again.*

**Appendix**

**From the printer**

Buttons that are used in the following settings

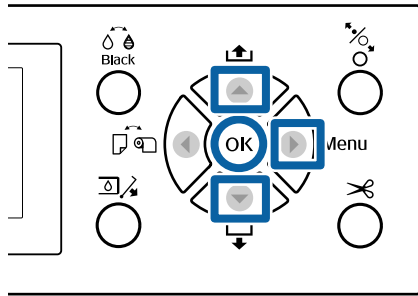

**1** Press the ► button on the printer's control panel to display the Settings menu.

**2** Press the ▼/▲ buttons to select **Paper**, and then press the ► button.  
The Paper menu will be displayed.

**3** Press the ▼/▲ buttons to select **Custom Paper Setting**, and then press the ► button.  
The Custom Paper Setting menu is displayed.

**4** Press the ▼/▲ buttons to select the custom paper number (1 to 10) that you want to save the settings to, and then press the OK button.

A setting items screen is displayed. If you select a number to which settings have already been saved, the setting is overwritten.

Make sure you set the following three items.

- Select Reference Paper**
- Detect Paper Thickness**
- Paper Feed Adjust**

See the following for more information on each setup item.

[“Custom Paper Setting” on page 117](#)

**From the printer driver**

- Windows**  
Open the **Main** screen, and then save the settings in **Custom Settings** from **Paper Configuration**.  
[“Adding a Paper Type” on page 63](#)

- Mac OS X**  
Select **Paper Configuration** from the list, make settings, and then save the settings in Presets.  
[“Saving to Presets” on page 68](#)

## Appendix

# Notes When Moving or Transporting the Printer

This section describes precaution when moving and transporting the product.

## Notes When Moving the Printer

This section assumes that the product is being moved to another location on the same floor without traversing stairs, ramps, or lifts. See the following section for information on moving the printer between floors or to another building.

 [“Notes on Transporting” on page 180](#)



### Caution:

Do not tilt the product more than 10 degrees forward or back while moving it. Failure to observe this precaution could result in the printer falling over, causing accidents.



### Important:

Do not remove the ink cartridges. Failure to observe this precaution could cause the print head nozzles to dry out.

## Getting Ready

1

Confirm that the printer is off.

2

Disconnect the power cords and all other cables.

3

Place the paper basket in its storage position.

 [“Storing” on page 42](#)

4

Remove the optional auto take-up reel unit or SpectroProofer mounter if they are installed.

 Setup Guide (booklet) supplied with optional items

5

Unlock the casters.

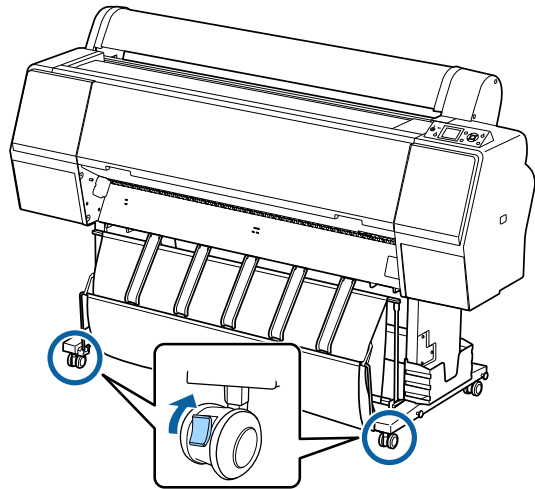

6

Move the printer.



### Important:

Use the casters to move the printer indoors a short distance over a level floor. They can not be used for transport.

## Notes on Transporting

Make the following preparations in advance before transporting the printer.

- Turn off the printer and remove all cables.
- Remove any paper.
- Remove any optional components if they are installed.  
To remove the optional components, see the *Setup guide* included with each of them, and then reverse the attachment procedure.

Furthermore, repack it using the original box and packing materials to protect it from shock and vibration.

When packing, make sure you install protective material to secure the print head.

See the "Setup Guide" (booklet) supplied with the printer for the installation method, and install in the original location before the printer was removed.

Appendix

**Caution:**

- ❑ The printer is heavy. When you pack or move the printer, use four or more people when carrying it.
- ❑ When you lift the printer, maintain a natural posture.
- ❑ When you lift the printer, place your hands at the locations indicated in the following illustration.  
If you lift the printer while holding other sections, you may be injured. For example, you may drop the printer or your fingers may be pinched when lowering the printer.

When you move the printer while packaging it, place your hands at the positions in the illustration, and then lift.

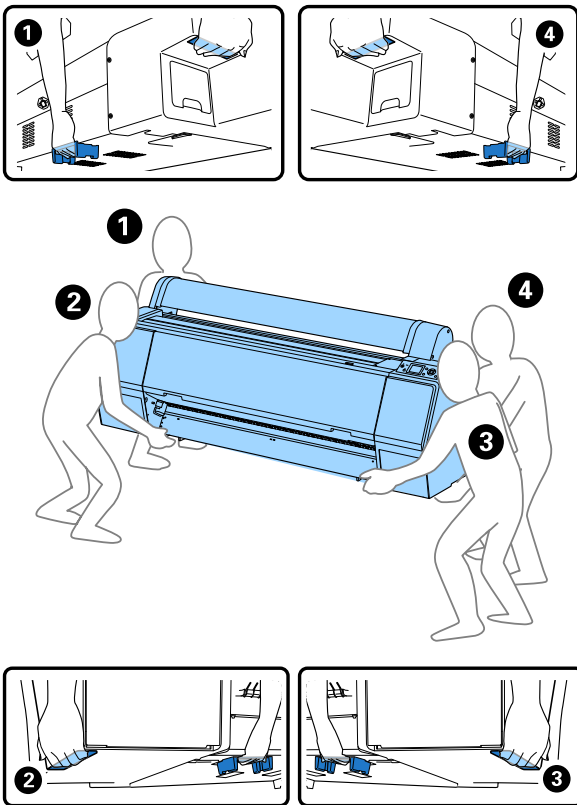

**Important:**

- ❑ Only hold the required area; otherwise, the printer may be damaged. Failure to observe this precaution could damage the printer.
- ❑ Move and transport the printer with ink cartridges installed. Do not remove the ink cartridges; otherwise, the nozzles may be clogged and make it impossible to print, or ink may leak.

**Notes when reusing the printer**

After moving or transporting the printer, follow the steps below to put it into a ready status.

See the Choosing a Place for the Printer section of the "Setup Guide" (booklet) in advance to make sure the location is suitable for installing the printer.

- 1 See the "Setup Guide" to install the printer.  
📖 "Setup Guide" (booklet)

**Important:**

Make sure you lock the casters after installing the printer.

- 2 Print a check pattern and check for clogged nozzles.  
📖 "From the printer" on page 126
- 3 Perform Head Alignment (auto adjustment).  
📖 "From the printer" on page 126

Appendix

# System Requirements

## System Requirements of the Printer Driver

The following chart shows the system requirements to install and use the printer driver included with this printer. For information on supported operating systems, see the Epson website.

### Windows

Operating system	Windows XP/Windows XP x64 Windows Vista//Windows Vista x64 Windows 7/Windows 7 x64 Windows 8/Windows 8 x64 Windows 8.1/Windows 8.1 x64 Windows Server 2003/Windows Server 2003 x64/Windows Server 2008/Windows Server 2008 x64/Windows Server 2008 R2/Windows Server 2012
CPU	Core 2 Duo 3.05 GHz or better
Memory	1 GB or more available memory
Available hard disk space	32 GB or more
Interface	Hi-Speed USB-Compatible with the USB 2.0 Specification.*1 Ethernet 10BASE-T, 100BASE-TX/1000BASE-T*2
Display resolution	SVGA (800 x 600) or higher resolution

\*1 When using a USB hub (a relay device for connecting multiple USB devices) during a USB connection, we recommend making a direct connection to the computer with the first tier USB hub. Depending on the USB hub you are using, the operation of the printer may become unstable. If this should occur, plug the USB cable directly into your computer's USB port.

\*2 Use a shielded twisted-pair cable (Category 5 or higher).

**Note:**

When installing, you must log in as a user with an computer administrator account (a user belonging to the Administrators group).

### Mac OS X

Operating system	Mac OS X v10.6.8 or later
CPU	Core 2 Duo 3.05 GHz or better
Memory	1 GB or more available memory
Available hard disk space	32 GB or more
Display resolution	WXGA (1280 x 800) or higher resolution
Interface	Hi-Speed USB-Compatible with the USB 2.0 Specification.*1 Ethernet 10BASE-T, 100BASE-TX/1000BASE-T*2

\*1 When using a USB hub (a relay device for connecting multiple USB devices) during a USB connection, we recommend making a direct connection to the computer with the first tier USB hub. Depending on the USB hub you are using, the operation of the printer may become unstable. If this should occur, plug the USB cable directly into your computer's USB port.

\*2 Use a shielded twisted-pair cable (Category 5 or higher).

Appendix

# Specifications Table

Printer Specifications	
Printing method	On-demand ink jet
Nozzle configuration	<b>SC-P9000 Series/SC-P7000 Series</b> 360 nozzles x 10 colors (Cyan, Light Cyan, Vivid Magenta, Vivid Light Magenta, Yellow, Orange, Green, Violet*/Light Light Black*, Light Black, Photo Black/Matte Black) * Select one of these colors.
	<b>SC-P8000 Series/SC-P6000 Series</b> 360 nozzles x 8 colors (Cyan, Light Cyan, Vivid Magenta, Vivid Light Magenta, Yellow, Light Light Black, Light Black, Photo Black/Matte Black)
Resolution (maximum)	2880x1440 dpi
Control code	ESC/P raster (undisclosed command)
Media feed method	Friction feed
Built-in memory	1GB for Main 64MB for Network
Network Functions	IPv4/v6, WSD, SSL communications, IEEE802.1X, SNMPv1/v2c/v3*1
Rated voltage	AC 100 to 240 V
Rated frequency	50 to 60 Hz
Rated current	2A
Power consumption	
In use	<b>SC-P9000 Series/SC-P8000 Series</b> Approximately 75 W <b>SC-P7000 Series/SC-P6000 Series</b> Approximately 65 W
Ready mode	Approximately 19 W
Sleep mode	Approximately 2.0 W
Power off	0.5 W or less

Printer Specifications	
Temperature	Operating: 10 to 35 °C (50 to 95°F) Storage (before unpacking): -20 to 60 °C (-4 to 140°F) (within 120 hours at 60 °C (140°F), within a month at 40 °C (104°F)) Storage (after unpacking): -20 to 40 °C (-4 to 104°F) (within a month at 40 °C (104°F))
Humidity	Operating: 20 to 80% (without condensation) Storage (before unpacking): 5 to 85% (without condensation) Storage (after unpacking): 5 to 85% (without condensation)
Operating temperature/humidity (optional Hard Disk Unit not installed)	
Operating temperature/humidity (optional Hard Disk Unit installed)	

Appendix

Printer Specifications	
Dimension	<p><b>SC-P9000 Series/SC-P8000 Series</b> Paper basket closed: (W) 1864 x (D) 667 x (H) 1218mm</p> <p>Using the paper basket (opened fully): (W) 1864 x (D) 1318 x (H) 1218mm</p> <p><b>SC-P7000 Series/SC-P6000 Series</b> Paper basket closed: (W) 1356 x (D) 667 x (H) 1218mm</p> <p>Using the paper basket (opened fully): (W) 1356 x (D) 903 x (H) 1218mm</p>
Weight* <sup>2</sup>	<p>SC-P9000 Series/SC-P8000 Series: Approximately 135kg</p> <p>SC-P7000 Series/SC-P6000 Series: Approximately 101kg</p>

\* 1 Do SNMP settings from Remote Manager.

 ["Remote Manager" on page 26](#)

\* 2 Without ink cartridges.

Ink Specifications	
Type	Special ink cartridges
Pigment ink	<p><b>SC-P9000 Series/SC-P7000 Series</b> Black: Light Light Black, Light Black, Photo Black, Matte Black</p> <p>Color: Cyan, Light Cyan, Vivid Magenta, Vivid Light Magenta, Yellow, Orange, Green, Violet</p> <p><b>SC-P8000 Series/SC-P6000 Series</b> Black: Light Light Black, Light Black, Photo Black, Matte Black</p> <p>Color: Cyan, Light Cyan, Vivid Magenta, Vivid Light Magenta, Yellow</p>
Use by date	See the date printed on the package (at normal temperature)
Print quality guarantee expiry	Six months (after installing in the printer)
Storage temperature	<p>Uninstalled: -20 to 40°C (within a month at 40°C)</p> <p>Installed in printer: -20 to 40°C (within a month at 40°C)</p> <p>Transporting: -20 to 60°C (within 1 month at 40°C, within 72 hours at 60°C)</p>
Cartridge dimensions	<p>700 ml: (W) 40 x (D) 320 x (H) 107mm</p> <p>350 ml/150 ml: (W) 40 x (D) 240 x (H) 107mm</p>



**Important:**

- The ink freezes if left at below -15°C for a long time. If it does freeze, leave it at room temperature (25°C) for at least four hours (without condensation).*
- Do not disassemble or refill the ink cartridges.*

## Information of EU Declaration of Conformity

The full text of the EU declaration of conformity for this equipment is available at the following internet address.



## Appendix

<http://www.epson.eu/conformity>

## Where To Get Help

---

# Where To Get Help

---

## Technical Support Web Site

Epson's Technical Support Web Site provides help with problems that cannot be solved using the troubleshooting information in your product documentation. If you have a Web browser and can connect to the Internet, access the site at:

<http://support.epson.net/>

If you need the latest drivers, FAQs, manuals, or other downloadables, access the site at:

<http://www.epson.com>

Then, select the support section of your local Epson Web site.

## Contacting Epson Support

---

### Before Contacting Epson

If your Epson product is not operating properly and you cannot solve the problem using the troubleshooting information in your product documentation, contact Epson support services for assistance. If Epson support for your area is not listed below, contact the dealer where you purchased your product.

Epson support will be able to help you much more quickly if you give them the following information:

- Product serial number  
(The serial number label is usually on the back of the product.)
- Product model
- Product software version  
(Click **About**, **Version Info**, or similar button in the product software.)
- Brand and model of your computer
- Your computer operating system name and version
- Names and versions of the software applications you normally use with your product

## Where To Get Help

### Help for Users in North America

Epson provides the technical support services listed below.

#### Internet Support

Visit Epson's support website at <http://epson.com/support> and select your product for solutions to common problems. You can download drivers and documentation, get FAQs and troubleshooting advice, or e-mail Epson with your questions.

#### Speak to a Support Representative

Dial: (562) 276-1300 (U.S.), or (905) 709-9475 (Canada), 6 am to 6 pm, Pacific Time, Monday through Friday. Days and hours of support are subject to change without notice. Toll or long distance charges may apply.

Before you call Epson for support, please have the following information ready:

- Product name
- Product serial number
- Proof of purchase (such as a store receipt) and date of purchase
- Computer configuration
- Description of the problem

**Note:**

*For help using any other software on your system, see the documentation for that software for technical support information.*

#### Purchase Supplies and Accessories

You can purchase genuine Epson ink cartridges, ribbon cartridges, paper, and accessories from an Epson authorized reseller. To find the nearest reseller, call 800-GO-EPSON (800-463-7766). Or you can purchase online at <http://www.epsonstore.com> (U.S. sales) or <http://www.epson.ca> (Canadian sales).

### Help for Users in Europe

Check your **Pan-European Warranty Document** for information on how to contact Epson support.

### Help for Users in Australia

Epson Australia wishes to provide you with a high level of customer service. In addition to your product documentation, we provide the following sources for obtaining information:

#### Your Dealer

Don't forget that your dealer can often help identify and resolve problems. The dealer should always be the first call for advice on problems; they can often solve problems quickly and easily as well as give advice on the next step to take.

#### Internet URL

<http://www.epson.com.au>

Access the Epson Australia World Wide Web pages. Worth taking your modem here for the occasional surf! The site provides a download area for drivers, Epson contact points, new product information and technical support (e-mail).

#### Epson Helpdesk

Epson Helpdesk is provided as a final backup to make sure our clients have access to advice. Operators on the Helpdesk can aid you in installing, configuring and operating your Epson product. Our Pre-sales Helpdesk staff can provide literature on new Epson products and advise where the nearest dealer or service agent is located. Many types of queries are answered here.

The Helpdesk numbers are:

Phone:	1300 361 054
Fax:	(02) 8899 3789

## Where To Get Help

We encourage you to have all the relevant information on hand when you ring. The more information you prepare, the faster we can help solve the problem. This information includes your Epson product documentation, type of computer, operating system, application programs, and any information you feel is required.

---

### Help for Users in Singapore

Sources of information, support, and services available from Epson Singapore are:

#### World Wide Web

(<http://www.epson.com.sg>)

Information on product specifications, drivers for download, Frequently Asked Questions (FAQ), Sales Enquiries, and Technical Support via e-mail are available.

#### Epson HelpDesk (Phone: (65) 6586 3111)

Our HelpDesk team can help you with the following over the phone:

- Sales enquiries and product information
- Product usage questions or problems
- Enquiries on repair service and warranty

---

### Help for Users in Thailand

Contacts for information, support, and services are:

#### World Wide Web

(<http://www.epson.co.th>)

Information on product specifications, drivers for download, Frequently Asked Questions (FAQ), and e-mail are available.

#### Epson Hotline (Phone: (66) 2685 -9899)

Our Hotline team can help you with the following over the phone:

- Sales enquiries and product information
- Product usage questions or problems
- Enquiries on repair service and warranty

---

### Help for Users in Vietnam

Contacts for information, support, and services are:

Epson Hotline (Phone): 84-8-823-9239

Service Center: 80 Truong Dinh Street,  
District 1, Hochiminh City  
Vietnam

---

### Help for Users in Indonesia

Contacts for information, support, and services are:

#### World Wide Web

(<http://www.epson.co.id>)

- Information on product specifications, drivers for download
- Frequently Asked Questions (FAQ), Sales Enquiries, questions through e-mail

#### Epson Hotline

- Sales enquiries and product information
- Technical support
 

Phone	(62) 21-572 4350
Fax	(62) 21-572 4357

#### Epson Service Center

Jakarta      Mangga Dua Mall 3rd floor No 3A/B  
Jl. Arteri Mangga Dua,  
Jakarta

Phone/Fax: (62) 21-62301104

## Where To Get Help

Bandung	Lippo Center 8th floor Jl. Gatot Subroto No.2 Bandung  Phone/Fax: (62) 22-7303766
Surabaya	Hitech Mall It IIB No. 12 Jl. Kusuma Bangsa 116 – 118 Surabaya  Phone: (62) 31-5355035 Fax: (62)31-5477837
Yogyakarta	Hotel Natour Garuda Jl. Malioboro No. 60 Yogyakarta  Phone: (62) 274-565478
Medan	Wisma HSBC 4th floor Jl. Diponegoro No. 11 Medan  Phone/Fax: (62) 61-4516173
Makassar	MTC Karebosi Lt. III Kav. P7-8 Jl. Ahmad Yani No.49 Makassar  Phone: (62)411-350147/411-350148

---

## Help for Users in Hong Kong

To obtain technical support as well as other after-sales services, users are welcome to contact Epson Hong Kong Limited.

### Internet Home Page

Epson Hong Kong has established a local home page in both Chinese and English on the Internet to provide users with the following information:

- Product information
- Answers to Frequently Asked Questions (FAQs)
- Latest versions of Epson product drivers

Users can access our World Wide Web home page at:

<http://www.epson.com.hk>

## Technical Support Hotline

You can also contact our technical staff at the following telephone and fax numbers:

Phone: (852) 2827-8911

Fax: (852) 2827-4383

---

## Help for Users in Malaysia

Contacts for information, support, and services are:

### World Wide Web

<http://www.epson.com.my>

- Information on product specifications, drivers for download
- Frequently Asked Questions (FAQ), Sales Enquiries, questions through e-mail

### Epson Trading (M) Sdn. Bhd.

Head Office.

Phone: 603-56288288

Fax: 603-56288388/399

### Epson Helpdesk

- Sales enquiries and product information (Infoline)  
Phone: 603-56288222
- Enquiries on repair services & warranty, product usage and technical support (Techline)  
Phone: 603-56288333

---

## Help for Users in India

Contacts for information, support, and services are:

## Where To Get Help

### World Wide Web

(<http://www.epson.co.in>)

Information on product specifications, drivers for download, and products enquiry are available.

### Epson India Head Office - Bangalore

Phone: 080-30515000

Fax: 30515005

### Epson India Regional Offices:

Location	Telephone number	Fax number
Mumbai	022-28261515 / 16/17	022-28257287
Delhi	011-30615000	011-30615005
Chennai	044-30277500	044-30277575
Kolkata	033-22831589 / 90	033-22831591
Hyderabad	040-66331738/ 39	040-66328633
Cochin	0484-2357950	0484-2357950
Coimbatore	0422-2380002	NA
Pune	020-30286000 / 30286001 /30286002	020-30286000
Ahmedabad	079-26407176 / 77	079-26407347

### Helpline

For Service, Product info or to order a cartridge - 18004250011 (9AM - 9PM) - This is a Toll-free number.

For Service (CDMA & Mobile Users) - 3900 1600 (9AM - 6PM) Prefix local STD code

## Help for Users in the Philippines

To obtain technical support as well as other after sales services, users are welcome to contact the Epson Philippines Corporation at the telephone and fax numbers and e-mail address below:

Trunk Line: (63-2) 706 2609

Fax: (63-2) 706 2665

Helpdesk Direct Line: (63-2) 706 2625

E-mail: [epchelpdesk@epc.epson.com.ph](mailto:epchelpdesk@epc.epson.com.ph)

### World Wide Web

(<http://www.epson.com.ph>)

Information on product specifications, drivers for download, Frequently Asked Questions (FAQ), and E-mail Enquiries are available.

**Toll-Free No. 1800-1069-EPSON(37766)**

Our Hotline team can help you with the following over the phone:

- Sales enquiries and product information
- Product usage questions or problems
- Enquiries on repair service and warranty

## Software License Terms

---

# Software License Terms

---

## OPEN SOURCE SOFTWARE LICENSE

- 1) This printer product includes open source software programs listed in Section 5) according to the license terms of each open source software program.
- 2) We provide the source code of the GPL Programs, LGPL Programs, Apache License Program and ncftp license Program (each is defined in Section 5) until five (5) years after the discontinuation of same model of this printer product. If you desire to receive the source code above, please see the "Contacting Epson Support" in the User's Guide, and contact the customer support of your region. You shall comply with the license terms of each open source software program.
- 3) The open source software programs are WITHOUT ANY WARRANTY; without even the implied warranty of MERCHANTABILITY AND FITNESS FOR A PARTICULAR PURPOSE. See the license agreements of each open source software program for more details, which are described on \Manual\Data\oss.pdf in the Printer Software Disc.
- 4) The license terms of each open source software program are described on \Manual\Data\oss.pdf in the Printer Software Disc.
- 5) The list of open source software programs which this printer product includes are as follows.

### GNU GPL

This printer product includes the open source software programs which apply the GNU General Public License Version 2 or later version ("GPL Programs").

The list of GPL Programs:

linux-2.6.35-arm1-epson12  
 busybox-1.17.4  
 ethtool-2.6.35  
 e2fsprogs-1.41.14  
 scrub-2.4  
 smartmontools-5.40  
 WPA Supplicant 0.7.3  
 Shred(Coreutils v8.23)

### GNU Lesser GPL

This printer product includes the open source software programs which apply the GNU Lesser General Public License Version 2 or later version ("Lesser GPL Programs").

The list of LGPL Programs:

uclibc-0.9.32  
 libusb-1.0.8  
 libiConv-1.14

### Apache License

This printer product includes the open source software program "Bonjour" which apply the Apache License Version 2.0 ("Apache License Program").

### Bonjour License

## Software License Terms

This printer product includes the open source software program “Bonjour” which applies the terms and conditions provided by owner of the copyright to the “Bonjour”.

### Net-SNMP license

This printer product includes the open source software program “Net-SNMP” which applies the terms and conditions provided by owner of the copyright to the “Net-SNMP”.

### BSD License (Berkeley Software Distribution License)

This printer product includes the open source software program which apply the Berkeley Software Distribution License (“BSD Program”).

The list of BSD Licence Programs:

busybox-1.17.4

WPA Supplicant 0.7.3

### Sun RPC License

This printer product includes the open source software program “busybox-1.17.4” which apply the Sun RPC License (“Sun RPC Program”).

### ncftp license

This printer product includes the open source software program “ncftp-3.2.4” which applies the terms and conditions provided by owner of the copyright to the “ncftp”.

### e2fsprogs license

This printer product includes the open source software program “e2fsprogs-1.41.14” which applies the terms and conditions provided by owner of the copyright to the “e2fsprogs”.

### MIT license

This printer product includes the open source software program “jQuery v1.8.2” which apply the MIT License.

---

## Bonjour

This printer product includes the open source software programs which apply the Apple Public Source License Version1.2 or its latest version ("Bonjour Programs").

We provide the source code of the Bonjour Programs pursuant to the Apple Public Source License Version1.2 or its latest version until five (5) years after the discontinuation of same model of this printer product. If you desire to receive the source code of the Bonjour Programs, please see the "Contacting Customer Support" in Appendix or Printing Guide of this User's Guide, and contact the customer support of your region.

You can redistribute Bonjour Programs and/or modify it under the terms of the Apple Public Source License Version1.2 or its latest version.

These Bonjour Programs are WITHOUT ANY WARRANTY; without even the implied warranty of MERCHANTABILITY AND FITNESS FOR A PARTICULAR PURPOSE.

The Apple Public Source License Version1.2 is as follows. You also can see the Apple Public Source License Version1.2 at <http://www.opensource.apple.com/apsl/>.

APPLE PUBLIC SOURCE LICENSE

Version 2.0 - August 6, 2003



## Software License Terms

1. General; Definitions. This License applies to any program or other work which Apple Computer, Inc. ("Apple") makes publicly available and which contains a notice placed by Apple identifying such program or work as "Original Code" and stating that it is subject to the terms of this Apple Public Source License version 2.0 ("License"). As used in this License:

1.1 "Applicable Patent Rights" mean: (a) in the case where Apple is the grantor of rights, (i) claims of patents that are now or hereafter acquired, owned by or assigned to Apple and (ii) that cover subject matter contained in the Original Code, but only to the extent necessary to use, reproduce and/or distribute the Original Code without infringement; and (b) in the case where You are the grantor of rights, (i) claims of patents that are now or hereafter acquired, owned by or assigned to You and (ii) that cover subject matter in Your Modifications, taken alone or in combination with Original Code.

1.2 "Contributor" means any person or entity that creates or contributes to the creation of Modifications.

1.3 "Covered Code" means the Original Code, Modifications, the combination of Original Code and any Modifications, and/or any respective portions thereof.

1.4 "Externally Deploy" means: (a) to sublicense, distribute or otherwise make Covered Code available, directly or indirectly, to anyone other than You; and/or (b) to use Covered Code, alone or as part of a Larger Work, in any way to provide a service, including but not limited to delivery of content, through electronic communication with a client other than You.

1.5 "Larger Work" means a work which combines Covered Code or portions thereof with code not governed by the terms of this License.

1.6 "Modifications" mean any addition to, deletion from, and/or change to, the substance and/or structure of the Original Code, any previous Modifications, the combination of Original Code and any previous Modifications, and/or any respective portions thereof. When code is released as a series of files, a Modification is: (a) any addition to or deletion from the contents of a file containing Covered Code; and/or (b) any new file or other representation of computer program statements that contains any part of Covered Code.

1.7 "Original Code" means (a) the Source Code of a program or other work as originally made available by Apple under this License, including the Source Code of any updates or upgrades to such programs or works made available by Apple under this License, and that has been expressly identified by Apple as such in the header file(s) of such work; and (b) the object code compiled from such Source Code and originally made available by Apple under this License

1.8 "Source Code" means the human readable form of a program or other work that is suitable for making modifications to it, including all modules it contains, plus any associated interface definition files, scripts used to control compilation and installation of an executable (object code).

1.9 "You" or "Your" means an individual or a legal entity exercising rights under this License. For legal entities, "You" or "Your" includes any entity which controls, is controlled by, or is under common control with, You, where "control" means (a) the power, direct or indirect, to cause the direction or management of such entity, whether by contract or otherwise, or (b) ownership of fifty percent (50%) or more of the outstanding shares or beneficial ownership of such entity.

2. Permitted Uses; Conditions & Restrictions. Subject to the terms and conditions of this License, Apple hereby grants You, effective on the date You accept this License and download the Original Code, a world-wide, royalty-free, non-exclusive license, to the extent of Apple's Applicable Patent Rights and copyrights covering the Original Code, to do the following:

2.1 Unmodified Code. You may use, reproduce, display, perform, internally distribute within Your organization, and Externally Deploy verbatim, unmodified copies of the Original Code, for commercial or non-commercial purposes, provided that in each instance:

## Software License Terms

(a) You must retain and reproduce in all copies of Original Code the copyright and other proprietary notices and disclaimers of Apple as they appear in the Original Code, and keep intact all notices in the Original Code that refer to this License; and

(b) You must include a copy of this License with every copy of Source Code of Covered Code and documentation You distribute or Externally Deploy, and You may not offer or impose any terms on such Source Code that alter or restrict this License or the recipients' rights hereunder, except as permitted under Section 6.

2.2 Modified Code. You may modify Covered Code and use, reproduce, display, perform, internally distribute within Your organization, and Externally Deploy Your Modifications and Covered Code, for commercial or non-commercial purposes, provided that in each instance You also meet all of these conditions:

(a) You must satisfy all the conditions of Section 2.1 with respect to the Source Code of the Covered Code;

(b) You must duplicate, to the extent it does not already exist, the notice in Exhibit A in each file of the Source Code of all Your Modifications, and cause the modified files to carry prominent notices stating that You changed the files and the date of any change; and

(c) If You Externally Deploy Your Modifications, You must make Source Code of all Your Externally Deployed Modifications either available to those to whom You have Externally Deployed Your Modifications, or publicly available. Source Code of Your Externally Deployed Modifications must be released under the terms set forth in this License, including the license grants set forth in Section 3 below, for as long as you Externally Deploy the Covered Code or twelve (12) months from the date of initial External Deployment, whichever is longer. You should preferably distribute the Source Code of Your Externally Deployed Modifications electronically (e.g. download from a web site).

2.3 Distribution of Executable Versions. In addition, if You Externally Deploy Covered Code (Original Code and/or Modifications) in object code, executable form only, You must include a prominent notice, in the code itself as well as in related documentation, stating that Source Code of the Covered Code is available under the terms of this License with information on how and where to obtain such Source Code.

2.4 Third Party Rights. You expressly acknowledge and agree that although Apple and each Contributor grants the licenses to their respective portions of the Covered Code set forth herein, no assurances are provided by Apple or any Contributor that the Covered Code does not infringe the patent or other intellectual property rights of any other entity. Apple and each Contributor disclaim any liability to You for claims brought by any other entity based on infringement of intellectual property rights or otherwise. As a condition to exercising the rights and licenses granted hereunder, You hereby assume sole responsibility to secure any other intellectual property rights needed, if any. For example, if a third party patent license is required to allow You to distribute the Covered Code, it is Your responsibility to acquire that license before distributing the Covered Code.

3. Your Grants. In consideration of, and as a condition to, the licenses granted to You under this License, You hereby grant to any person or entity receiving or distributing Covered Code under this License a non-exclusive, royalty-free, perpetual, irrevocable license, under Your Applicable Patent Rights and other intellectual property rights (other than patent) owned or controlled by You, to use, reproduce, display, perform, modify, sublicense, distribute and Externally Deploy Your Modifications of the same scope and extent as Apple's licenses under Sections 2.1 and 2.2 above.

4. Larger Works. You may create a Larger Work by combining Covered Code with other code not governed by the terms of this License and distribute the Larger Work as a single product. In each such instance, You must make sure the requirements of this License are fulfilled for the Covered Code or any portion thereof.

5. Limitations on Patent License. Except as expressly stated in Section 2, no other patent rights, express or implied, are granted by Apple herein. Modifications and/or Larger Works may require additional patent licenses from Apple which Apple may grant in its sole discretion.

## Software License Terms

6. Additional Terms. You may choose to offer, and to charge a fee for, warranty, support, indemnity or liability obligations and/or other rights consistent with the scope of the license granted herein ("Additional Terms") to one or more recipients of Covered Code. However, You may do so only on Your own behalf and as Your sole responsibility, and not on behalf of Apple or any Contributor. You must obtain the recipient's agreement that any such Additional Terms are offered by You alone, and You hereby agree to indemnify, defend and hold Apple and every Contributor harmless for any liability incurred by or claims asserted against Apple or such Contributor by reason of any such Additional Terms.

7. Versions of the License. Apple may publish revised and/or new versions of this License from time to time. Each version will be given a distinguishing version number. Once Original Code has been published under a particular version of this License, You may continue to use it under the terms of that version. You may also choose to use such Original Code under the terms of any subsequent version of this License published by Apple. No one other than Apple has the right to modify the terms applicable to Covered Code created under this License.

8. NO WARRANTY OR SUPPORT. The Covered Code may contain in whole or in part pre-release, untested, or not fully tested works. The Covered Code may contain errors that could cause failures or loss of data, and may be incomplete or contain inaccuracies. You expressly acknowledge and agree that use of the Covered Code, or any portion thereof, is at Your sole and entire risk. THE COVERED CODE IS PROVIDED "AS IS" AND WITHOUT WARRANTY, UPGRADES OR SUPPORT OF ANY KIND AND APPLE AND APPLE'S LICENSOR(S) (COLLECTIVELY REFERRED TO AS "APPLE" FOR THE PURPOSES OF SECTIONS 8 AND 9) AND ALL CONTRIBUTORS EXPRESSLY DISCLAIM ALL WARRANTIES AND/OR CONDITIONS, EXPRESS OR IMPLIED, INCLUDING, BUT NOT LIMITED TO, THE IMPLIED WARRANTIES AND/OR CONDITIONS OF MERCHANTABILITY, OF SATISFACTORY QUALITY, OF FITNESS FOR A PARTICULAR PURPOSE, OF ACCURACY, OF QUIET ENJOYMENT, AND NONINFRINGEMENT OF THIRD PARTY RIGHTS. APPLE AND EACH CONTRIBUTOR DOES NOT WARRANT AGAINST INTERFERENCE WITH YOUR ENJOYMENT OF THE COVERED CODE, THAT THE FUNCTIONS CONTAINED IN THE COVERED CODE WILL MEET YOUR REQUIREMENTS, THAT THE OPERATION OF THE COVERED CODE WILL BE UNINTERRUPTED OR ERROR-FREE, OR THAT DEFECTS IN THE COVERED CODE WILL BE CORRECTED. NO ORAL OR WRITTEN INFORMATION OR ADVICE GIVEN BY APPLE, AN APPLE AUTHORIZED REPRESENTATIVE OR ANY CONTRIBUTOR SHALL CREATE A WARRANTY. You acknowledge that the Covered Code is not intended for use in the operation of nuclear facilities, aircraft navigation, communication systems, or air traffic control machines in which case the failure of the Covered Code could lead to death, personal injury, or severe physical or environmental damage.

9. LIMITATION OF LIABILITY. TO THE EXTENT NOT PROHIBITED BY LAW, IN NO EVENT SHALL APPLE OR ANY CONTRIBUTOR BE LIABLE FOR ANY INCIDENTAL, SPECIAL, INDIRECT OR CONSEQUENTIAL DAMAGES ARISING OUT OF OR RELATING TO THIS LICENSE OR YOUR USE OR INABILITY TO USE THE COVERED CODE, OR ANY PORTION THEREOF, WHETHER UNDER A THEORY OF CONTRACT, WARRANTY, TORT (INCLUDING NEGLIGENCE), PRODUCTS LIABILITY OR OTHERWISE, EVEN IF APPLE OR SUCH CONTRIBUTOR HAS BEEN ADVISED OF THE POSSIBILITY OF SUCH DAMAGES AND NOTWITHSTANDING THE FAILURE OF ESSENTIAL PURPOSE OF ANY REMEDY. SOME JURISDICTIONS DO NOT ALLOW THE LIMITATION OF LIABILITY OF INCIDENTAL OR CONSEQUENTIAL DAMAGES, SO THIS LIMITATION MAY NOT APPLY TO YOU. In no event shall Apple's total liability to You for all damages (other than as may be required by applicable law) under this License exceed the amount of fifty dollars (\$50.00).

10. Trademarks. This License does not grant any rights to use the trademarks or trade names "Apple", "Apple Computer", "Mac", "Mac OS", "QuickTime", "QuickTime Streaming Server" or any other trademarks, service marks, logos or trade names belonging to Apple (collectively "Apple Marks") or to any trademark, service mark, logo or trade name belonging to any Contributor. You agree not to use any Apple Marks in or as part of the name of products derived from the Original Code or to endorse or promote products derived from the Original Code other than as expressly permitted by and in strict compliance at all times with Apple's third party trademark usage guidelines which are posted at <http://www.apple.com/legal/guidelinesfor3rdparties.html>.

## Software License Terms

11. Ownership. Subject to the licenses granted under this License, each Contributor retains all rights, title and interest in and to any Modifications made by such Contributor. Apple retains all rights, title and interest in and to the Original Code and any Modifications made by or on behalf of Apple ("Apple Modifications"), and such Apple Modifications will not be automatically subject to this License. Apple may, at its sole discretion, choose to license such Apple Modifications under this License, or on different terms from those contained in this License or may choose not to license them at all.

12. Termination.

12.1 Termination. This License and the rights granted hereunder will terminate:

(a) automatically without notice from Apple if You fail to comply with any term(s) of this License and fail to cure such breach within 30 days of becoming aware of such breach;

(b) immediately in the event of the circumstances described in Section 13.5(b); or

(c) automatically without notice from Apple if You, at any time during the term of this License, commence an action for patent infringement against Apple; provided that Apple did not first commence an action for patent infringement against You in that instance.

12.2 Effect of Termination. Upon termination, You agree to immediately stop any further use, reproduction, modification, sublicensing and distribution of the Covered Code. All sublicenses to the Covered Code which have been properly granted prior to termination shall survive any termination of this License. Provisions which, by their nature, should remain in effect beyond the termination of this License shall survive, including but not limited to Sections 3, 5, 8, 9, 10, 11, 12.2 and 13. No party will be liable to any other for compensation, indemnity or damages of any sort solely as a result of terminating this License in accordance with its terms, and termination of this License will be without prejudice to any other right or remedy of any party.

13. Miscellaneous.

13.1 Government End Users. The Covered Code is a "commercial item" as defined in FAR 2.101. Government software and technical data rights in the Covered Code include only those rights customarily provided to the public as defined in this License. This customary commercial license in technical data and software is provided in accordance with FAR 12.211 (Technical Data) and 12.212 (Computer Software) and, for Department of Defense purchases, DFAR 252.227-7015 (Technical Data -- Commercial Items) and 227.7202-3 (Rights in Commercial Computer Software or Computer Software Documentation). Accordingly, all U.S. Government End Users acquire Covered Code with only those rights set forth herein.

13.2 Relationship of Parties. This License will not be construed as creating an agency, partnership, joint venture or any other form of legal association between or among You, Apple or any Contributor, and You will not represent to the contrary, whether expressly, by implication, appearance or otherwise.

13.3 Independent Development. Nothing in this License will impair Apple's right to acquire, license, develop, have others develop for it, market and/or distribute technology or products that perform the same or similar functions as, or otherwise compete with, Modifications, Larger Works, technology or products that You may develop, produce, market or distribute.

13.4 Waiver; Construction. Failure by Apple or any Contributor to enforce any provision of this License will not be deemed a waiver of future enforcement of that or any other provision. Any law or regulation which provides that the language of a contract shall be construed against the drafter will not apply to this License.

## Software License Terms

13.5 Severability. (a) If for any reason a court of competent jurisdiction finds any provision of this License, or portion thereof, to be unenforceable, that provision of the License will be enforced to the maximum extent permissible so as to effect the economic benefits and intent of the parties, and the remainder of this License will continue in full force and effect. (b) Notwithstanding the foregoing, if applicable law prohibits or restricts You from fully and/or specifically complying with Sections 2 and/or 3 or prevents the enforceability of either of those Sections, this License will immediately terminate and You must immediately discontinue any use of the Covered Code and destroy all copies of it that are in your possession or control.

13.6 Dispute Resolution. Any litigation or other dispute resolution between You and Apple relating to this License shall take place in the Northern District of California, and You and Apple hereby consent to the personal jurisdiction of, and venue in, the state and federal courts within that District with respect to this License. The application of the United Nations Convention on Contracts for the International Sale of Goods is expressly excluded.

13.7 Entire Agreement; Governing Law. This License constitutes the entire agreement between the parties with respect to the subject matter hereof. This License shall be governed by the laws of the United States and the State of California, except that body of California law concerning conflicts of law.

Where You are located in the province of Quebec, Canada, the following clause applies: The parties hereby confirm that they have requested that this License and all related documents be drafted in English.

Les parties ont exigé que le présent contrat et tous les documents connexes soient rédigés en anglais.

EXHIBIT A.

"Portions Copyright (c) 1999-2003 Apple Computer, Inc. All Rights Reserved.

This file contains Original Code and/or Modifications of Original Code as defined in and that are subject to the Apple Public Source License Version 2.0 (the 'License'). You may not use this file except in compliance with the License. Please obtain a copy of the License at <http://www.opensource.apple.com/apsl/> and read it before using this file.

The Original Code and all software distributed under the License are distributed on an 'AS IS' basis, WITHOUT WARRANTY OF ANY KIND, EITHER EXPRESS OR IMPLIED, AND APPLE HEREBY DISCLAIMS ALL SUCH WARRANTIES, INCLUDING WITHOUT LIMITATION, ANY WARRANTIES OF MERCHANTABILITY, FITNESS FOR A PARTICULAR PURPOSE, QUIET ENJOYMENT OR NON-INFRINGEMENT. Please see the License for the specific language governing rights and limitations under the License."

## Other Software Licenses

---

### Info-ZIP copyright and license

This is version 2007-Mar-4 of the Info-ZIP license. The definitive version of this document should be available at <ftp://ftp.info-zip.org/pub/infozip/license.html> indefinitely and a copy at <http://www.info-zip.org/pub/infozip/license.html>.

Copyright © 1990-2007 Info-ZIP. All rights reserved.

For the purposes of this copyright and license, "Info-ZIP" is defined as the following set of individuals:

Mark Adler, John Bush, Karl Davis, Harald Denker, Jean-Michel Dubois, Jean-loup Gailly, Hunter Goatley, Ed Gordon, Ian Gorman, Chris Herborth, Dirk Haase, Greg Hartwig, Robert Heath, Jonathan Hudson, Paul Kienitz, David Kirschbaum, Johnny Lee, Onno van der Linden, Igor Mandrichenko, Steve P. Miller, Sergio Monesi, Keith Owens, George Petrov, Greg Roelofs, Kai Uwe Rommel, Steve Salisbury, Dave Smith, Steven M. Schweda, Christian Spieler, Cosmin Truta, Antoine Verheijen, Paul von Behren, Rich Wales, Mike White.

## Software License Terms

Permission is granted to anyone to use this software for any purpose, including commercial applications, and to alter it and redistribute it freely, subject to the above disclaimer and the following restrictions:

1. Redistributions of source code (in whole or in part) must retain the above copyright notice, definition, disclaimer, and this list of conditions.
2. Redistributions in binary form (compiled executables and libraries) must reproduce the above copyright notice, definition, disclaimer, and this list of conditions in documentation and/or other materials provided with the distribution. The sole exception to this condition is redistribution of a standard UnZipSFX binary (including SFXWiz) as part of a self-extracting archive; that is permitted without inclusion of this license, as long as the normal SFX banner has not been removed from the binary or disabled.
3. Altered versions--including, but not limited to, ports to new operating systems, existing ports with new graphical interfaces, versions with modified or added functionality, and dynamic, shared, or static library versions not from Info-ZIP--must be plainly marked as such and must not be misrepresented as being the original source or, if binaries, compiled from the original source. Such altered versions also must not be misrepresented as being Info-ZIP releases--including, but not limited to, labeling of the altered versions with the names "Info-ZIP" (or any variation thereof, including, but not limited to, different capitalizations), "Pocket UnZip," "WiZ" or "MacZip" without the explicit permission of Info-ZIP. Such altered versions are further prohibited from misrepresentative use of the Zip-Bugs or Info-ZIP e-mail addresses or the Info-ZIP URL(s), such as to imply Info-ZIP will provide support for the altered versions.
4. Info-ZIP retains the right to use the names "Info-ZIP," "Zip," "UnZip," "UnZipSFX," "WiZ," "Pocket UnZip," "Pocket Zip," and "MacZip" for its own source and binary releases.